



2013 – 2014







**PL**

SPIS TREŚCI

PL 1-24





# Spis treści

Świece zapłonowe, świece żarowe, końcówki przewodów zapłonowych mogą być zastosowane zgodnie z przyporządkowaniem w naszym katalogu.

Widoczne pomyłki i błędy w druku podlegają szczególnej uwadze użytkowników. NGK gwarantuje bezbłądność oraz właściwości produktów odpowiadające obecnemu poziomowi techniki. Gwarancja obowiązuje tylko w przypadku prawidłowej eksploatacji produktów NGK. Gwarancja na błędy materiałowe wynosi 24 miesiące od dnia zakupu, jeżeli określone przez producenta pojazdu okresy wymiany nie zostały przekroczone. Wyłączone z tego są: normalne zużycie oraz produkty eksploatowane w sporcie motorowym.

Uwagi:

1. Lista zastosowań służy wyłącznie wyborowi typów.
2. Przez publikację niniejszego wydania wszystkie poprzednie listy zastosowań tracą ważność.
3. Treść nie jest podstawą jakichkolwiek roszczeń prawnych. Niniejsze wydanie nie zawiera poleceń dla lotniczych zespołów napędowych według wytycznych FAA.
4. Nie podlega gwarancji przy normalnym zużyciu lub wykorzystywaniu w sporcie.

<b>Wyposażenie oryginalne (OE) na świecie</b> .....	<b>(P)</b>	<b>2</b>
<b>Momenty dokręcenia świec zapłonowych</b> .....	<b>(P)</b>	<b>3</b>
<b>Momenty dokręcenia świec żarowych</b> .....	<b>(P)</b>	<b>3</b>
<b>Oznakowania świec zapłonowych</b> .....	<b>(P)</b>	<b>4 – 5</b>
<b>Oznakowania świec żarowych</b> .....	<b>(P)</b>	<b>6 – 7</b>
<b>Lista porównawcza świec zapłonowych</b> .....	<b>(P)</b>	<b>8</b>
<b>V-Line</b> .....	<b>(P)</b>	<b>9 – 13</b>
<b>LPG LaserLine</b> .....	<b>(P)</b>	<b>14 – 17</b>
<b>D-Power</b> .....	<b>(P)</b>	<b>18</b>
<b>Świece żarowe ceramiczne</b> .....	<b>(P)</b>	<b>19</b>
<b>Przegląd D-Power</b> .....	<b>(P)</b>	<b>20</b>
<b>Świece zapłonowe sportowe</b> .....	<b>(P)</b>	<b>21 – 23</b>
<b>Lokalizacja numerów silnika</b> .....	<b>(P)</b>	<b>24</b>
<b>Serie świec zapłonowych</b> .....		<b>1 – 11</b>
<b>Serie świec żarowych</b> .....		<b>12 – 34</b>
<b>Świece zapłonowe i żarowe dla samochodów osobowych od 1990</b> .....		<b>35 – 268</b>
<b>Lista porównawcza</b> .....		<b>269 – 381</b>
<b>PS (HP) ↔ KW</b> .....		<b>382</b>

Termin 30.06.2013

Zastrzega się możliwość zmian  
2013 – 2014



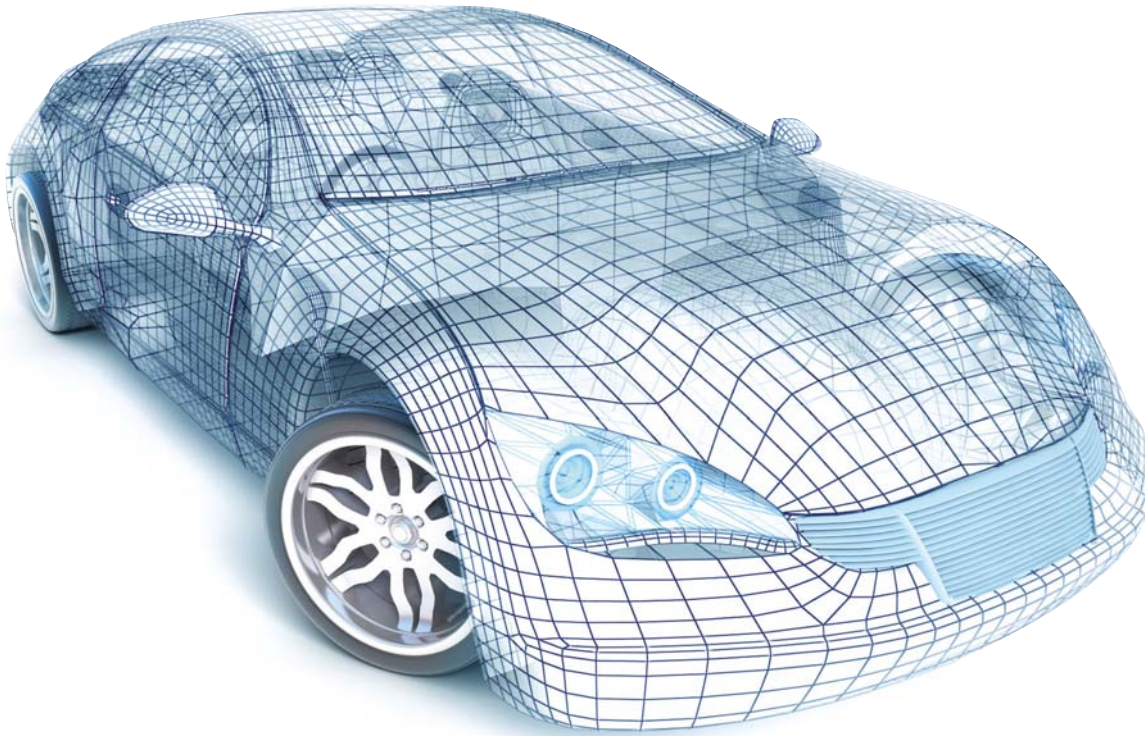

## Świece zapłonowe i żarowe NGK – światowego producenta wyposażenia oryginalnego (OEM)

Producent	Świece zapłonowe	Świece żarowe
Alfa Romeo	●	●
AMG	●	
Aston Martin	●	
Audi	●	●
Bentley	●	
BMW	●	
Bugatti	●	
Chrysler	●	
Citroën	●	●
Daewoo	●	
Daihatsu	●	●
Ferrari	●	
Fiat	●	●
Ford	●	●
General Motors	●	
Honda	●	●
Hyundai	●	●
Isuzu	●	●
Jaguar	●	●
Kia	●	●
Lancia	●	●

Producent	Świece zapłonowe	Świece żarowe
Land Rover	●	●
Lamborghini	●	
Lotus	●	
Maserati	●	
Mazda	●	●
Mercedes	●	●
Mitsubishi	●	●
Nissan	●	●
Opel	●	
Porsche	●	●
Peugeot	●	●
Renault	●	●
Saab	●	
Seat	●	●
Škoda	●	●
Smart	●	●
Subaru	●	●
Suzuki	●	●
Toyota	●	●
Volkswagen	●	●
Volvo	●	●





## Momenty dokręcenia świec zapłonowych

### Momenty dokręcenia

Do fachowego montażu świecy zapłonowej konieczny jest klucz dynamometryczny. Ponieważ sami fachowcy warsztatowi nie są w stanie dokładnie ocenić momentu dokręcenia.

Wynika to z tego, że moment dokręcenia oblicza się na podstawie dwóch wielkości, które wzajemnie mnoży się: siły, która działa w danym punkcie obrotu oraz długości dźwigni.

Większość awarii świec zapłonowych spowodowanych jest błędnym momentem dokręcenia. Jeśli moment dokręcenia wybierze się za mały, może nastąpić utrata sprężenia i przegrzanie. Możliwe jest również pęknięcie izolatora lub elektrody środkowej na skutek drgań.

Jeśli moment dokręcenia wybierze się za duży, może dojść do zerwania świecy zapłonowej. Także korpus nie będzie mógł się rozciągnąć ani przekręcić. Strefy odpływu ciepła będą zakłócone, istnieje niebezpieczeństwo przegrzania i stopienia elektrod aż do uszkodzenia silnika.

Material głowicy silnika	Świeca zapłonowa z płaskim gniazdem (z uszczelką)				Świeca zapłonowa ze stożkowym gniazdem	
	Średnica gwintu				Średnica gwintu	
	18 mm	14 mm	12 mm	10 mm	18 mm	14 mm
Głowica żeliwna	35-45 Nm	25-35 Nm	15-25 Nm	10-15 Nm	20-30 Nm	15-25 Nm
Głowica alumiowa	35-40 Nm	25-30 Nm	15-20 Nm	10-12 Nm	20-30 Nm	10-20 Nm

Momenty dokręcenia zależą od materiału głowicy silnika i średnicy gwintu

## Momenty dokręcenia świec żarowych

### Właściwy moment obrotowy

Do fachowego montażu świecy żarowej zaleca się stosowanie klucza dynamometrycznego. Ponieważ sami fachowcy warsztatowi nie są w stanie dokładnie ocenić momentu dokręcenia.

Wynika to z tego, że moment dokręcenia oblicza się na podstawie dwóch wielkości, które wzajemnie mnoży się: siły, która działa w danym punkcie obrotu oraz długości dźwigni.

Jeśli świecę żarową dokręci się niewłaściwym momentem obrotowym, może nastąpić utrata

kompresji. Ze względu na drgania w przypadku ceramicznych świec żarowych możliwe jest również pęknięcie ceramiki.

Także szczególnie użycie zbyt dużego momentu dokręcenia

może spowodować zmniejszenie się szczeliny pierścieniowej pomiędzy metalową obudową i rurką żarzenia. W takim przypadku nastąpi przegrzanie świecy żarowej i jej uszkodzenie.

Moment dokręcenia świec żarowych	
Średnica gwintu	Moment dokręcenia
8 mm	8-15 Nm
10 mm	15-20 Nm
12 mm	20-25 Nm
14 mm	20-25 Nm
18 mm	20-30 Nm

Moment dokręcenia nakrętek	
Średnica gwintu	Moment dokręcenia
4 mm (M4)	0,8-1,5 Nm
5 mm (M5)	3,0-4,0 Nm

Tylko wtedy, gdy świece żarowe dokręcone są właściwym momentem obrotowym, działają bez zarzutu.

# Oznakowania świec zapłonowych

Tutaj podano standardowe oznaczenie typu. Poza tym istnieją jeszcze specjalne oznaczenia.

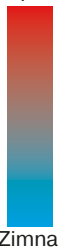
Średnica gwintu / rozwarłość klucza sześciokątnego		Struktura		Opornik przeciwwzrostociowy		Wartość cieplna	
<b>A</b>	18 mm / 25,4	P	Wysunięta końcówka izolatora	R	Opornik	2	 Ciepła Zimna
<b>B</b>	14 mm / 20,8	M	Świeca kompaktowa	Z	Oporność indukcyjna	4	
<b>C</b>	10 mm / 16,0	U	Iskra ślizgowa bądź półślizgowa			5	
<b>D</b>	12 mm / 18,0					6	
<b>E</b>	8 mm / 13,0	7					
<b>AB</b>	18 mm / 20,8	8					
<b>BC</b>	14 mm / 16,0	9					
<b>BK</b>	14 mm / 16,0	10					
<b>DC</b>	12 mm / 16,0						

**B P R 5 E S - 11**

Długość gwintu		Właściwości konstrukcyjne		Odstęp elektrod	
<b>E</b>	19,0 mm	<b>B</b>	Stała nakrętka SAE (CR8EB)	puste	Motocykl: 0.7-0.8mm, Samochód: 0.8-0.9mm
<b>EH</b>	19,0 mm, wykonany w połowie	<b>CM</b>	Elektroda masowa wykonana skośnie Typu kompaktowego (długość izolatora: 18.5mm)	-8	0,8 mm
<b>H</b>	12,7 mm	<b>CS</b>	Elektroda masowa wykonana skośnie Typu kompaktowego (długość izolatora: 18.5mm)	-9	0,9mm
<b>L</b>	11,2 mm	<b>G, GV</b>	Świece zapłonowe wyścigowe:	-10	1,0mm
<b>F</b>	Szczelne gniazdo stożkowe	<b>I</b>	Elektroda irydowa	-11	1,1mm
	A-F--- 10,9 mm	<b>IX</b>	Elektroda irydowa - typ IX	-13	1,3mm
	B-F--- 11,2 mm	<b>J</b>	2 elektrody masy (specjalnego kształtu)	-14	1,4mm
	B-EF-- 17,5 mm	<b>K</b>	2 elektrody masy	-15	1,5mm
	BM-F-- 7,8 mm	<b>-L</b>	zmniejszona wartość cieplna		
puste	Świeca kompaktowa	<b>-LM</b>	Typ kompaktowy (długość izolatora: 14.5mm)		
	BM--- 9,5 mm	<b>N</b>	Specjalna elektroda masowa	-S	Specjalny pierścień uszczelniający
	BPM-- 9,5 mm	<b>P</b>	Elektroda platynowa	-E	Specjalny opornik
	CM--- 9,5 mm	<b>Q</b>	4 elektrody masy		
		<b>S</b>	Typ standardowy		
		<b>T</b>	3 elektrody masy		
		<b>U</b>	Iskra półślizgowa		
		<b>VX</b>	Elektroda platynowa (typ VX)		
		<b>Y</b>	Elektroda środkowa z nacięciem V		
		<b>Z</b>	Specjalna konstrukcja		



# Oznakowania świec zapłonowych

Tutaj podano standardowe oznaczenie typu. Poza tym istnieją jeszcze specjalne oznaczenia.

Typ świecy		Wymiary gwintów i rozwarłość klucza sześciokątnego				
<b>D</b>	Wysoka zdolność zapłonu, Podwójne, cienkie elektrody	KA	Ø12.0	19,0mm	Pierścień uszczelniający	14,0
<b>I</b>	Świeca irydowa	KB	Ø12.0	19,0 mm	Pierścień uszczelniający	Bi-Hex 14.0
<b>L</b>	Długi gwint	MA	Ø10.0	19,0 mm	Pierścień uszczelniający	14,0
<b>P</b>	Świeca platynowa	NA	Ø12.0	17,5 mm	Szczelne gniazdo stożkowe	14,0
<b>S</b>	Wysoka zdolność zapłonu, kwadratowe końcówki elektrod	F	Ø14.0	19,0 mm	Pierścień uszczelniający	16,0
<b>Z</b>	Zwiększony odstęp elektrod	G	Ø14.0	19,0 mm	Pierścień uszczelniający	20,8
Powyższe oznaczenia mogą być łączone np. ILFR..., PLZFR... "L", oznacza szczególnie długi gwint i znajduje się przed wszystkimi innymi literami oznaczenia długości. n.p. • świeca z pierścieniem uszczelniającym FR5AP-11; długość gwintu 19.0mm LFR5AP-11; długość gwintu 26.5mm • świeca ze szczelnym gniazdem stożkowym PTR5C-13; długość gwintu 17.5mm PLTR6A-10G; długość gwintu 25.0mm		J	Ø12.0	19,0 mm	Pierścień uszczelniający	18,0
		K	Ø12.0	19,0 mm	Pierścień uszczelniający	16,0
		L	Ø10.0	12,7 mm	Pierścień uszczelniający	16,0
		M	Ø10.0	19,0 mm	Pierścień uszczelniający	16,0
		T	Ø14.0	17,5 mm	Szczelne gniazdo stożkowe	16,0
		U	Ø14.0	11,2 mm	Szczelne gniazdo stożkowe	16,0
		W	Ø18.0	10,9 mm	Szczelne gniazdo stożkowe	20,8
		X	Ø14.0	9,5 mm	Pierścień uszczelniający	20,8
		Y	Ø14.0	11,2 mm	Szczelne gniazdo stożkowe	16,0

P F R 5 A - 11

Opornik przeciwwzłóceńowy		Wartość cieplna		Konstrukcja		Odstęp elektrod	
<b>R</b>	Opornik	2	Ciepła Zimna	A,B,C... kod przyrostka	Cechy specjalne	puste	Motocykl: 0,7-0,8mm Samochód: 0.8-0.9mm
		4		- 7	0,7 mm		
		5		- 9	0,9 mm		
		6		I Świeca irydowa (jedna elektroda)	-10	1,0 mm	
		7		P Świeca platynowa (jedna elektroda)	-11	1,1 mm	
		8			-13	1,3 mm	
		9			-14	1,4 mm	
		10			-15	1,5 mm	
					-A	brak pierścienia uszczelniającego	
					-D	specjalna obudowa ulepszana cieplnie	
				-E	Specjalny opornik		
				-G	Elektroda masy z rdzeniem miedzianym		
				-H	Gwint specjalny		
				-J	2 elektrody masy		
				-K	Elektroda masy zabezpieczona przed drganiem		
				-N	Specjalna elektroda masy		
				-Q	4 elektrody masowe		
				-S	Specjalny pierścień uszczelniający		
				-T	3 elektrody masy		

# Oznakowanie świec żarowych metalowych

Y - 2 0 4 T S 1

Wykonanie / type		Średnica gwintu		Napięcie robocze		Numer seryjny	Charakterystyka żarzenia		Materiał prętu grzewczego	Numer modyfikacji
Y/YS	Świeca żarowa jednobiegunowa	1	10 mm	0-4	12 V	Ta cyfra oznacza numer seryjny	A	Typ AQGS	Specjalne	
YD	Świece żarowe dwubiegunowe	2	10 mm	5-9	24 V		J	Typ SRM		
		3	10 mm				R, M, U	Typ QGS		
		4	14 mm				T, V	Typ szybkiego rozruchu		
		5	10 mm				K lub brak litery	Typ standardowy		
		6	10 mm							
		7	10 mm							
		8	18 mm							
		9	12 mm							
							*Y-109, Y-159, Y-171 dla Caterpillar/ Mitsubishi posiadają średnicę gwintu 3/8" (ok. 9,5mm)			

Y 1 001 A S 1

Wykonanie / type		Średnica gwintu		Numer seryjny / Napięcie robocze		Charakterystyka żarzenia		Materiał prętu grzewczego	Numer modyfikacji
Stabglühkerze		1	10 mm	001-899	12 V	A	Typ AQGS	Specjalne	
		2	12 mm	901-999	24 V	J	Typ SRM		
		4	14 mm			R, M, U	Typ QGS		
		8	8 mm			T, V	Typ szybkiego rozruchu		
		9	9 mm			K lub brak litery	Typ standardowy		



# Oznakowanie świec żarowych metalowych

Y A 01

Świeca żarowa jednobiegunowa	Typ standardowy		Numer seryjny
	A	Typ standardowy	Numer seryjny
Średnica gwintu: 8mm lub 9mm	E	Typ QGS lub typ SRM	

DG 183F

Typ	Numer seryjny
Typ z zewnętrzną spiralą grzewczą	

# Oznakowanie świec żarowych ceramicznych

C Y 01

Wykonanie / typ	Charakterystyka żarzenia		Numer seryjny
Świece żarowe ceramiczne	X	Świece żarowe z podwójnym izolatorem	Numer seryjny
	Y	<b>Typu SRC</b> Typu samoregulacyjnego	
	Z	<b>Typ QGS</b> System szybkiego żarzenia	

## Uwagi do tabeli

- △ = tylko do pojazdów z blokadą przeciwruchomieniową
- ◆ = tylko do pojazdów bez blokady przeciwruchomieniowej

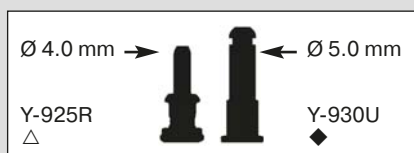

# Lista porównawcza świec zapłonowych

V-LINE	NGK	BERU	BOSCH	BOSCH +
Nr. 1	BUR6ET	14GH-7DTUR	WR7LTC+	+2
Nr. 2	BPR6E	14R-6DU 14R-7DU	WR6DC+ WR7DC+	+12 +1
Nr. 3	BPR6H	14R-6BU 14R-7BU	WR6BC WR7BC+	+10
Nr. 4	BP6E	14-6DU 14-7DU	W6DC W7DC	
Nr. 5	BP6EF	14K-6DU 14K-7DU	H6DC H7DC	
Nr. 6	BPR5E	14R-8DU 14R-9DU	WR8DC+ WR9DC+	+3 +16
Nr. 7	BPR6EF	14KR-6DU 14KR-7DU	HR6DC+ HR7DC+	+18 +5
Nr. 8	BP5E	14-8DU 14-9DU	W8DC W9DC	
Nr. 9	BPR5EY	-	-	
Nr.10	BPR6EY-11	-	-	
Nr.11	BCPR6E-11	-	-	
Nr.12	BCPR6E	-	-	
Nr.13	BPR6ES-11	14R-6DUX 14R-7DUX	WR6DCX WR7DCX+	+21
Nr.14	BKR6E-11	14FR-6DUX 14FR-7DUX	FR6DCX FR7DCX+	+11
Nr.15	ZGR5A	14-8LUR	WR8LC+ WR9LC	+34
Nr.16	BCP5E	14F-8DU	F8DC	
Nr.17	BCP6E	14F-7DU	F6DC F7DC	
Nr.18	BP6H	14-6BU 14-7BU	W6BC W7BC	
Nr.19	BPR7E	14R-5DU	WR5DC+	+15
Nr.20	BKR6EK	14FR-6LDU 14FR-7LDU	FR6LDC FR7LDC+	+7
Nr.21	BUR5ET-10	14GH-8DTURX	WR8LTC+	+4
Nr.22	BUR5ET	14GH-8DTUR	W8LTCR 0.8	
Nr.23	BKR5EK	14FR-8LDUOX4	FLR8LDCU+	+9
Nr.24	BKUR6ET-10	14FGH7DTURX	F7LTCR	
Nr.25	PTR5A-13	14KR-8MPX 14KR-8MUV	HR7MPP302 HR8MCV+	+3
Nr.26	BKR6EKC	14FR-6LDUW	-	
Nr.27	BKUR6ET	14FGH-6DTUR	FR6KTC	
Nr.28	BKR6E	14FR-6DU 14FR-7DU	FR6DC+ FR7DC+	+13 +8
Nr.29	BKUR5ET	14FGH-8DTURW	F8KTCR	
Nr.30	BKR6EQUP	14FR-7DQUP7	FGR7DQP+	+48
Nr.31	PTR5D-10	-	HR8DPP22U	
Nr.32	BCPR5E	-	-	
Nr.33	BKR5E-11	14FR-8DUX	FR8DCX+	+19
Nr.34	PZFR5D-11	14F-7HPURX2	FR7HPP33+	+52
Nr.35	BKR5E	14FR-8DU	FR8DC+ FR9DC	+6
Nr.36	BKR5EZ	-	-	
Nr.37	PFR6Q	14F-7 DPUR02	FR7KPP33+	+50
Nr.38	BKR6EZ	-	FR7DE FR6KDC+ FR7KDC	+53
Nr.39	BKR5EYA-11	14FR8KU0U	FR8KCU	



# V-Line – koncepcja sprzedaży z wieloma zaletami

## 1. System numerowy:

Liczyby od 1 do 39 umożliwiają szybkie znalezienie właściwej świecy zapłonowej.

## 2. Zwartość:

Mniejsze zopotrzebowanie miejsca dzięki zwartym wymiarom. Przez to więcej przestrzeni dla dodatkowych produktów.

## 3. Atrakcyjne opakowanie:

Charakter sygnałowy prowadzi do zakupów spontanicznych oraz forsuje wysprzedaż.

## 4. Wysoka szybkość obrotu:

39 typów dla 97 % wszystkich samochodów osobowych. Polepsza to Państwa zysk.



## 5. Dystrybucja w handlu jednobranżowym:

Brak konkurencji z domami towarowymi i supermarketami.

## 6. Obniżenie kosztów:

Niskie koszty magazynowania optymuja Państwa zysk.



## 7. Faktor ekologiczny:

Większa pewność zapłonu. Dzięki temu redukcja zużycia paliwa, wydzielania substancji szkodliwych oraz większa trwałość dla katalizatora. Przez to wysoka akceptacja przez klientów. Ekologiczne opakowanie kartonowe bez opakowania z tworzywa sztucznego typu blister.

## 8. Reklama dla użytkowników końcowych:

Firma NGK dba o wzrost zainteresowania swoich klientów.



Cały asortyment 39 numerów można oferować reprezentacyjnie i przejrzysto w stojaku. Załączona lista przyporządkowania całkowicie ułatwia wybór właściwej świecy zapłonowej!

# Świece zapłonowe V-Line oferują zalety w całej linii

**SZCZEGÓLNIIE W NOWOCZESNYCH SILNIKACH, KTÓRYCH MIESZANKA PALIOWO-POWIETRZNA JEST BARDZO UBOGA ZE WZGLĘDU NA KONIECZNOŚĆ REDUKCJI EMISJI SUBSTANCJI SZKODLIWYCH, KONSTRUKCJA NGK ZAPEWNIĄ ZAWSZE NIEZAWODNY ZAPŁON MIESZANKI, TAKŻE W EKSTREMALNYCH WARUNKACH EKSPLOATACYJNYCH!**

## Zalety techniczne:

Zastosowanie specjalnego materiału izolacyjnego umożliwia wydłużenie wierzchołka izolatora. Zoptymalizowany został ponadto miedziany rdzeń we wnętrzu elektrody środkowej. Oba udoskonalenia zapewniły jeszcze lepsze odprowadzanie ciepła. Zwiększony dzięki temu zakres temperatury gwarantuje pewne uruchomienie i niezawodny zapłon, także w ekstremalnych warunkach pracy silnika.



### **V-Line Nr. 1, 21, 22, 24, 27, 29 świeca zapłonowa z 3-ma elektrodami masowymi dla grupy Volkswagen**

NGK produkuje ten typ świec zapłonowych specjalnie dla pojazdów grupy VW. Można je stosować prawie we wszystkich nowych modelach (patrz tabela przyporządkowania). Odpowiadają one interwałom konserwacyjnym producenta pojazdów.

V-Line Nr. 1, 21, 22, 24, 27, 29



### **V-Line Nr. 2 - 12, 14 - 19, 28, 32, 33, 35, 36, 38, 39**

Technologicznie zasada jest genialnie prosta – i nader skuteczna. W elektrodzie środkowej świecy zapłonowej V-Line wykonane jest nacięcie typu V. Dzięki temu iskra przeskakuje na krawędź zewnętrzną elektrody środkowej. W tym miejscu znajduje się

więcej mieszanki paliwowo-powietrznej niż bezpośrednio między elektrodami. Poza tym mniejsze jest zapotrzebowanie na napięcie zapłonowe, a więc wzrasta niezawodność zapłonu!

V-Line Nr. 2-12, 14-19, 28, 32, 33, 35, 36, 38, 39



### **V-Line Nr. 20, 23**

Zasada działania świecy zapłonowej do samochodów BMW: W razie występowania przewodzących nagarów na wierzchołku izolatora, odpływające napięcie zapłonowe jest „wyłapywane” i powstaje iskra między izolatorem a elektrodą masową. Osady w rodzaju sadzy

są przy tym usuwane i dochodzi do niezakłóconego zapłonu mieszanki paliwowo-powietrznej.

V-Line Nr. 20, 23

### V-Line Nr. 25

Dla modeli FORDA wyposażonych w silniki ZETEC została opracowana przez NGK świeca zapłonowa z podwójną elektrodą platynową PTR5A-13. Zaletą elektrod platynowych jest niskie napięcie zapłonowe. W związku z tym możliwe było zwiększenie odległości elektrod pozwalające na uzyskanie stabilnego spalania i równomierności pracy na biegu

jałowym. Dzięki udoskonaleniu własności zapłonu można zoptymalizować zarówno emisję spalin, jak i moment obrotowy.



V-Line Nr. 25

### V-Line Nr. 26

We współpracy z FIATEM została opracowana przez NGK świeca zapłonowa BKR6EKC. Litera „C” oznacza specjalną świecę zapłonową do silników koncernu FIATA. BKR6EKC pracuje bez zarzutu także w najtrudniejszych warunkach – w ruchu „stop and go” przy niskich temperaturach spalania aż po najwyższe obciążenia termiczne silnika przy

pełnym obciążeniu pojazdu. Wyniki testów wykazują, że specjalna konstrukcja dwóch elektrod masowych gwarantuje najwyższą sprawność zapłonu oraz wymaganą trwałość świec w obrębie zalecanego przez Fiata interwału wymiany.



V-Line Nr. 26







V-Line Nr. 30

### V-Line Nr. 30

W tym przypadku chodzi o świecę o wydłużonej żywotności BKR6EQUP, która powstała w wyniku ścisłej współpracy pomiędzy BMW i NGK, wyposażoną w elektrodę platynową, 4 elektrody masy, jak również najnowocześniejszą technikę iskry półślizgowej. Zastosowanie techniki iskry półślizgowej wymaga specjalnego kształtu stożka izolatora. Poprzez to mamy pewność, że iskra zapłonowa zawsze przeskakuje tylko pomiędzy elektrodami, na których panują najkorzystniejsze warunki potrzebne do bezpiecznego zapłonu mieszanki paliwowo-powietrznej. Ponieważ każda iskra zapłonowa ślizga się po stożku izolatora

przed tym, jak przeskakuje przestrzeń powietrzną pomiędzy stożkiem izolatora a elektrodą boczną, wszystkie ewentualnie zgromadzone tam osady zostają natychmiast usunięte, zapobiegając możliwości wypadania iskry. Poprzez to gwarantowane jest optymalne zachowanie podczas startu zimnego silnika przy niskich temperaturach oraz pewny zapłon również na ekstremalnie krótkich odcinkach.

Ten nowy typ świecy zapłonowej NGK ma zastosowanie w silnikach BMW od rocznika 1997. Również można ją stosować w pewnych starszych modelach BMW od rocznika 1987.



V-Line Nr. 31, 34, 37

### V-Line Nr. 31, 34, 37

Dla modeli FORDA wyposażonych w silniki ENDURA została opracowana przez NGK świeca zapłonowa z podwójną elektrodą platynową PTR5D-10 (V-Line Nr. 31). Zaletą elektrod platynowych jest niskie napięcie zapłonowe. W związku z tym możliwe było zwiększenie odstępów elektrod pozwalające na uzyskanie

stabilnego spalania i równomierności pracy na biegu jałowym. Dzięki udoskonaleniu własności zapłonu można zoptymalizować zarówno emisję spalin, jak i moment obrotowy.

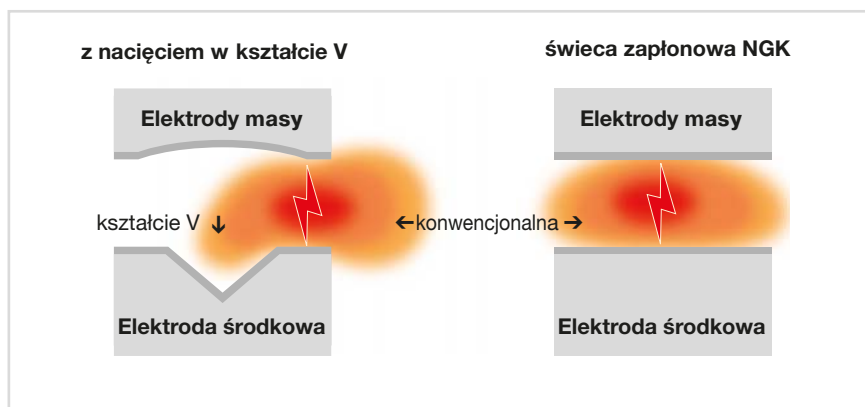

# Przegląd V-Line

V-Line	Typ	Producent pojazdu
1	BUR6ET	AUDI, FIAT, LANCIA, SEAT, SKODA, VW
2	BPR6E	ALFA ROMEO, AUSTIN, AUTOBIANCHI, BEDFORD, BMW, CHEVROLET, CHRYSLER, DAEWOO, DAIHATSU, FIAT, FORD, HONDA, INNOCENTI, ISUZU, KIA, LADA, LANCIA, LAND ROVER, LOTUS, MAZDA, MERCEDES-BENZ, MG, MITSUBISHI, MORGAN, NISSAN, OPEL, PANTHER, PININFARINA, PORSCHE, PROTON, RENAULT, ROVER, SEAT, SUBARU, SUZUKI, TALBOT, TVR, VAUXHALL, VOLVO, ZASTAVA
3	BPR6H	BEDFORD, FORD, OPE
4	BP6E	ALFA ROMEO, ASTON MARTIN, AUDI, AUSTIN, AUTOBIANCHI, BEDFORD, BMW, BOND, CITROËN, FIAT, FORD, FSO, GLAS, INNOCENTI, ISUZU, LADA, LANCIA, LAND ROVER, MASERATI, MERCEDES-BENZ, MG, MITSUBISHI, MORGAN, NISSAN, OPEL, PEUGEOT, RENAULT, ROVER, SAAB, SEAT, SUBARU, TALBOT, TRABANT, TRIUMPH, VAUXHALL, VOLVO, VW, WARTBURG, ZASTAVA, ZAZ
5	BP6EF	ALPINE, AUSTIN, CITROËN, LAND ROVER, MERCEDES-BENZ, PEUGEOT, PUCH, RENAULT, ROVER, TALBOT, TRIUMPH, VOLVO
6	BPR5E	ASIA MOTORS, BEDFORD, DAIHATSU, FIAT, HONDA, MARUTI, MAZDA, MITSUBISHI, NISSAN, OPEL, PROTON, RENAULT, SEAT, SUZUKI, TOYOTA, TRIUMPH, VAUXHALL, ZASTAVA
7	BPR6EF	FORD, LANCIA, RENAULT, VOLVO
8	BP5E	BMW, DAIMLER, HYUNDAI, ISUZU, JAGUAR, LAND ROVER, MG, MITSUBISHI, NISSAN, PEUGEOT, RENAULT, TRIUMPH, VW
9	BPR5EY	DAIHATSU, HONDA, SUZUKI, TOYOTA, VW
10	BPR6EY-11	DAIHATSU, HONDA, TOYOTA
11	BCPR6E-11	ACURA, FORD, FORD USA, HONDA, LADA, MAZDA, MITSUBISHI, NISSAN, ROVER, SAAB, SUBARU
12	BCPR6E	ASTON MARTIN, AUTOBIANCHI, CHEVROLET, CHRYSLER, CITROËN, DAIMLER, FIAT, FORD, FSO, JAGUAR, LANCIA, MAZDA, MORGAN, NISSAN, PEUGEOT, PONTIAC, RENAULT, ROVER, SAAB, SKODA, TVR, VOLVO
13	BPR6ES-11	HYUNDAI, ISUZU, KIA, MAZDA, MITSUBISHI, NISSAN, OPEL, SUBARU
14	BKR6E-11	CHEVROLET, DAEWOO, DAIHATSU, HONDA, ISUZU, KIA, MAZDA, MITSUBISHI, NISSAN, PEUGEOT, PROTON, ROVER, SUBARU, SUZUKI
15	ZGR5A	BERTONE, BMW
16	BCP5E	CITROËN, DAEWOO, MERCEDES-BENZ, PEUGEOT, RENAULT, SAAB, SSANGYONG
17	BCP6E	ALFA ROMEO, CITROËN, MERCEDES-BENZ, NISSAN, PEUGEOT, PUCH, RENAULT, ROVER
18	BP6H	CITROËN, DACIA, DAF, FORD, MERCEDES-BENZ, OPEL, PORSCHE, RENAULT, SEAT, SKODA, TALBOT, TRABANT, VOLVO, WARTBURG
19	BPR7E	ALFA ROMEO, AUSTIN, AUTOBIANCHI, FIAT, FORD, LANCIA, LOTUS, MITSUBISHI, PININFARINA, PORSCHE, RENAULT, SUBARU, TALBOT, VOLVO
20	BKR6EK	ALPINA, BERTONE, BMW, CITROËN, DAEWOO, FIAT, LANCIA, MERCEDES-BENZ, OPEL, PEUGEOT, PORSCHE, SAAB, VAUXHALL, WIESMANN
21	BUR5ET-10	AUDI, SAAB, SEAT, VW
22	BUR5ET	AUDI, SEAT, VW
23	BKR5EK	CHEVROLET, CITROËN, DAEWOO, FIAT, LANCIA, NISSAN, OPEL, PEUGEOT, RENAULT, SAAB, VAUXHALL
24	BKUR6ET-10	AUDI, MERCEDES-BENZ, SEAT, SKODA, VW
25	PTR5A-13	CHEVROLET, FORD, HUMMER, MAZDA, MORGAN
26	BKR6EKC	DAIHATSU, FIAT, LANCIA, LOTUS
27	BKUR6ET	FIAT, LANCIA, SEAT, VW
28	BKR6E	AUDI, AUSTIN, CATERHAM, CHRYSLER, CITROËN, DACIA, FIAT, HYUNDAI, KIA, LADA, LAND ROVER, MAZDA, MERCEDES-BENZ, NISSAN, OPEL, PANTHER, PEUGEOT, PORSCHE, RENAULT, ROVER, SKODA, SUZUKI, VOLVO, VW
29	BKUR5ET	MERCEDES-BENZ, VW
30	BKR6EQUP	ALPINA, AUDI, BENTLEY, BMW, LAND ROVER, MINI, MORGAN, PORSCHE, ROLLS-ROYCE, VOLVO
31	PTR5D-10	FORD, MAZD
32	BCPR5E	CITROËN, PEUGEOT, RENAULT, SKODA
33	BKR5E-11	CHEVROLET, DAEWOO, DAIHATSU, HYUNDAI, INFINITI, KIA, MAZDA, MITSUBISHI, NISSAN, SUBARU
34	PZFR5D-11	FORD, SEAT, SKODA, VW
35	BKR5E	KIA, MAZDA, NISSAN, VW
36	BKR5EZ	CITROËN, FIAT, LANCIA, PEUGEOT, RENAULT
37	PFR6Q	AUDI, BENTLEY, SEAT, SKODA, VW
38	BKR6EZ	CITROËN, DACIA, FIAT, LANCIA, NISSAN, PEUGEOT, RENAULT
39	BKR5EYA-11	TOYOTA

# LPG LaserLine – Asortyment jak żaden inny

Specjalny asortyment świec zapłonowych do silników zasilanych gazem LPG/CNG stworzony przez NGK.

- Dla silników zasilanych gazem LPG lub CNG
- Elementy platynowe i irydowe na obu elektrodach: spawane laserowo
- Specjalna warstwa ochronna pokrywająca korpus świecy: chroni i ułatwia demontaż
- Bezproblemowy montaż: optymalnie fabrycznie ustawiony odstęp elektrod
- Tylko 8 referencji – aż 95% pokrycie rynku

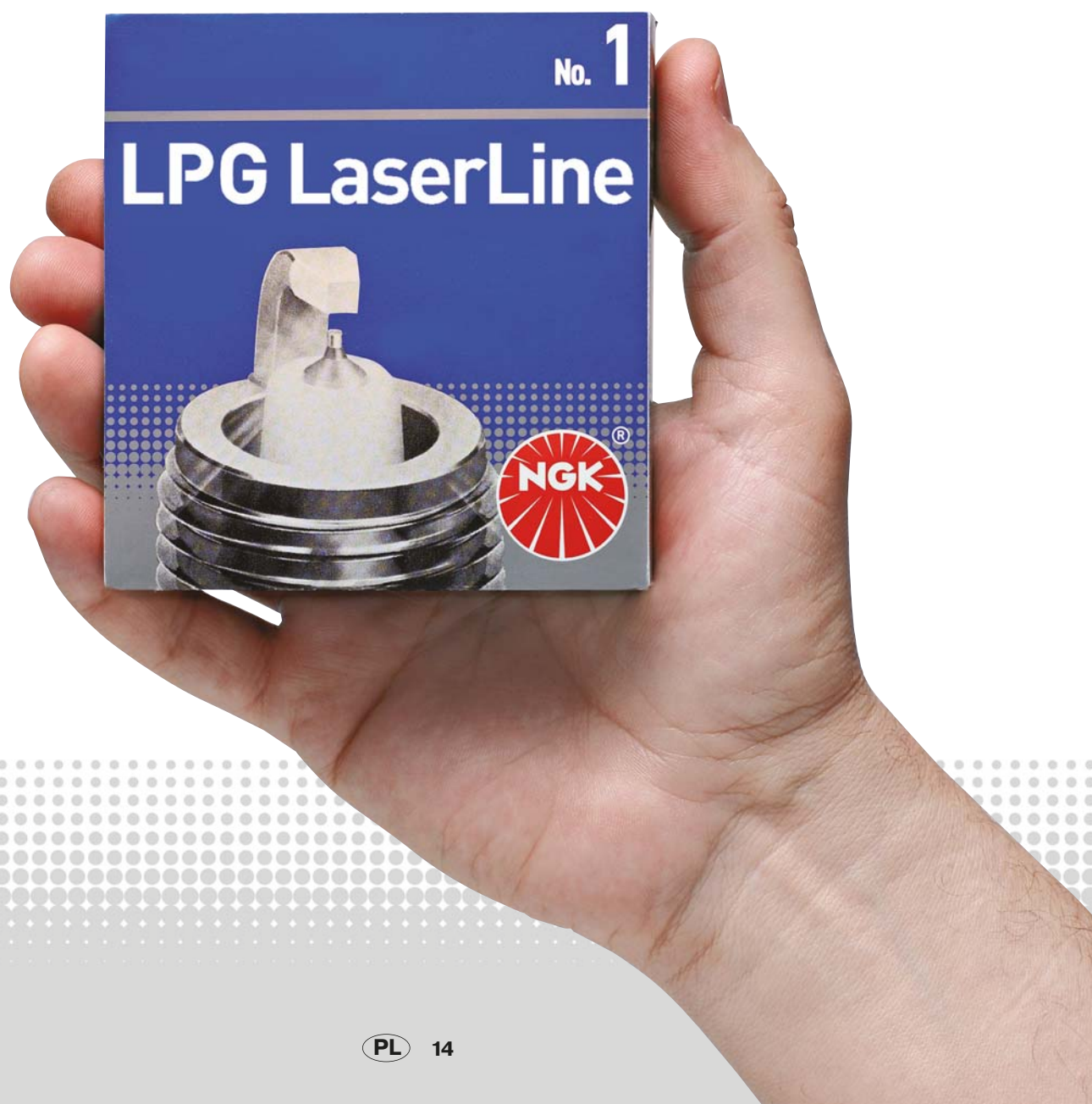



# LPG LaserLine – najlepsze dla silników zasilanych gazem

**LPG LaserLine to asortyment, w skład którego wchodzi wyłącznie dla silników zasilanych gazem. Dla warsztatów i dystrybutorów oznacza to łatwiejszy dobór odpowiedniego typu świecy zapłonowej oraz pewniejszy serwis.**

Ze względu na niższą cenę gazu, zmiana sposobu zasilania silnika przynosi korzyści w całej Europie. Dlatego ilość aut przerabianych na zasilanie gazem zwiększa się z roku na rok. Dystrybutor i warsztat może również czerpać z tego widoczne korzyści.

Do tej pory przy wyborze świec zapłonowych do silników zasilanych gazem trzeba było uwzględnić wiele czynników, ponieważ zapłon gazu jest trudniejszy niż zapłon benzyny. Wiązało się to więc z dodatkową pracą.

Wraz ze wzrostem zapotrzebowania na napięcie zapłonowe (patrz wykres), rośnie również ryzyko uszkodzenia cewki zapłonowej, ponieważ mieszanka gazowo-powietrzna spala się w wyższej temperaturze.

Elektrody i korpusy świec wykonane ze standardowych materiałów w tych warunkach o wiele szybciej ulegają korozji.

Ponadto świeca zapłonowa musi odprowadzać więcej ciepła z komory spalania. Najlepszym rozwiązaniem tego problemu było indywidualne dopasowanie wartości cieplnej oraz odstępów elektrod świecy zapłonowej.

Teraz dostępne jest lepsze rozwiązanie: asortyment świec zapłonowych **LPG LaserLine**. Ten asortyment pokrywa 90% zapotrzebowania na świece zapłonowe do silników zasilanych gazem LPG/CNG, w niektórych krajach nawet do 97%. Tym samym **LPG LaserLine** oferuje idealną świecę zapłonową dla prawie każdego auta zasilanego gazem LPG lub CNG.

**Zapotrzebowanie na napięcie zapłonowe wzrasta w silnikach zasilanych gazem.**

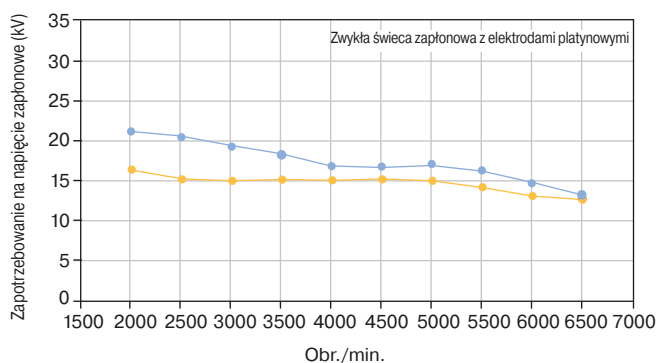

Benzyna 95 okt. — Odstęp elektrod 0,80 mm  
Gaz płynny (LPG): — Odstęp elektrod 0,80 mm



# LPG LaserLine – High-tech dla silników zasilanych gazem



## 1. Elektrody z wykorzystaniem metali szlachetnych

### Świece zapłonowe LPG

**LaserLine** posiadają elektrodę środkową zakończoną stożkiem irydowym oraz elektrodę masy pokrytą płytką platynową. Oba te elementy zostały połączone z korpusem świecy przy wykorzystaniu opatentowanego przez NGK laserowego sposobu spawania. Odstęp elektrod pozostaje niezmienny w całym zalecanym okresie eksploatacji świecy zapłonowej.

## 2. Idealny odstęp elektrod

W każdej referencji świecy zapłonowej **LPG LaserLine** jest ustawiany fabrycznie idealny odstęp elektrod. Manualna zmiana nie jest potrzebna.

## 3. Optymalna wartość cieplna

Miedziany rdzeń w elektrodzie środkowej każdej świecy **LPG LaserLine** usprawnia odprowadzanie ciepła z komory spalania i jednocześnie pomaga w utrzymaniu właściwej temperatury potrzebnej do optymalnego spalania mieszanki gazowo-powietrznej. Szczególne właściwości konstrukcyjne

jeszcze lepiej chronią te świece zapłonowe przed pokrywaniem się nagarem lub zakopceniem.

## 4. Specjalna warstwa ochronna korpusu świecy

Specjalna warstwa ochronna pokrywająca korpus każdej świecy

**LPG LaserLine** chroni ją przed działaniem wysokich temperatur oraz redukuje ryzyko korozji. Tego typu ochrony nie oferuje żaden inny producent.

## 5. Odciążenie cewki zapłonowej

Badania prowadzone przez NGK udowodniły, że w silnikach zasilanych gazem wzrasta zapotrzebowanie na napięcie zapłonowe do 7000 V, a to oznacza bardzo duży wzrost obciążenia cewki zapłonowej. Elektroda środkowa świecy zapłonowej o średnicy 0,6 mm znacznie zmniejsza to obciążenie oraz ułatwia kontakt mieszanki z iskrą zapłonową.

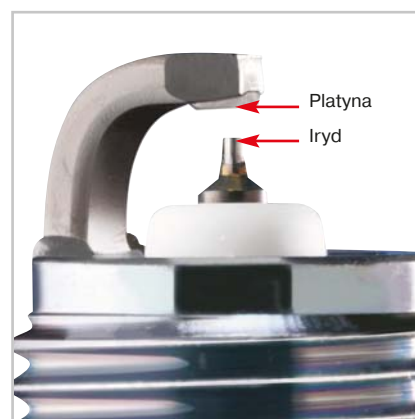

Elektroda środkowa ze stożkiem irydowym oraz elektroda masy z płytką platynową zapewniają najwyższą sprawność zapłonu w całym okresie eksploatacji świecy zapłonowej LPG LaserLine.

# LPG LaserLine – optymalne pokrycie rynku

**LPG LaserLine to 8 referencji specjalnych świec zapłonowych do silników zasilanych gazem LPG/CNG, idealnych dla 90% pojazdów dostępnych na rynku europejskim, w których można zastosować ten rodzaj zasilania.**

Tabela pokazuje 8 przykładów zastosowania świec zapłonowych **LPG LaserLine**.

Wszystkie zastosowania będą dostępne w katalogu świec zapłonowych NGK, w TecDoc oraz

w wyszukiwarce produktów NGK na stronie internetowej: [www.ngkntk.pl](http://www.ngkntk.pl).

## Przykłady zastosowań

Typ LPG	Pojazd	Silnik
LPG 1	Audi A6 2.4l V6	BDV
LPG 2	Volvo 940i 2.3l	B 230 FT
LPG 3	Saab 9-5 2.3l	B235L
LPG 4	Ford Focus 1.6l	FYDA Zetec SE
LPG 5	Ford Mondeo 2.0	CJBA Duratec HE
LPG 6	VW Multivan T5 2.8l	AXK
LPG 7	Peugeot 307 1.6l	TU5 JP4 NFU
LPG 8	Fiat Grande Punto 1.4	350A1000

## Zasada działania silnika zasilanego gazem

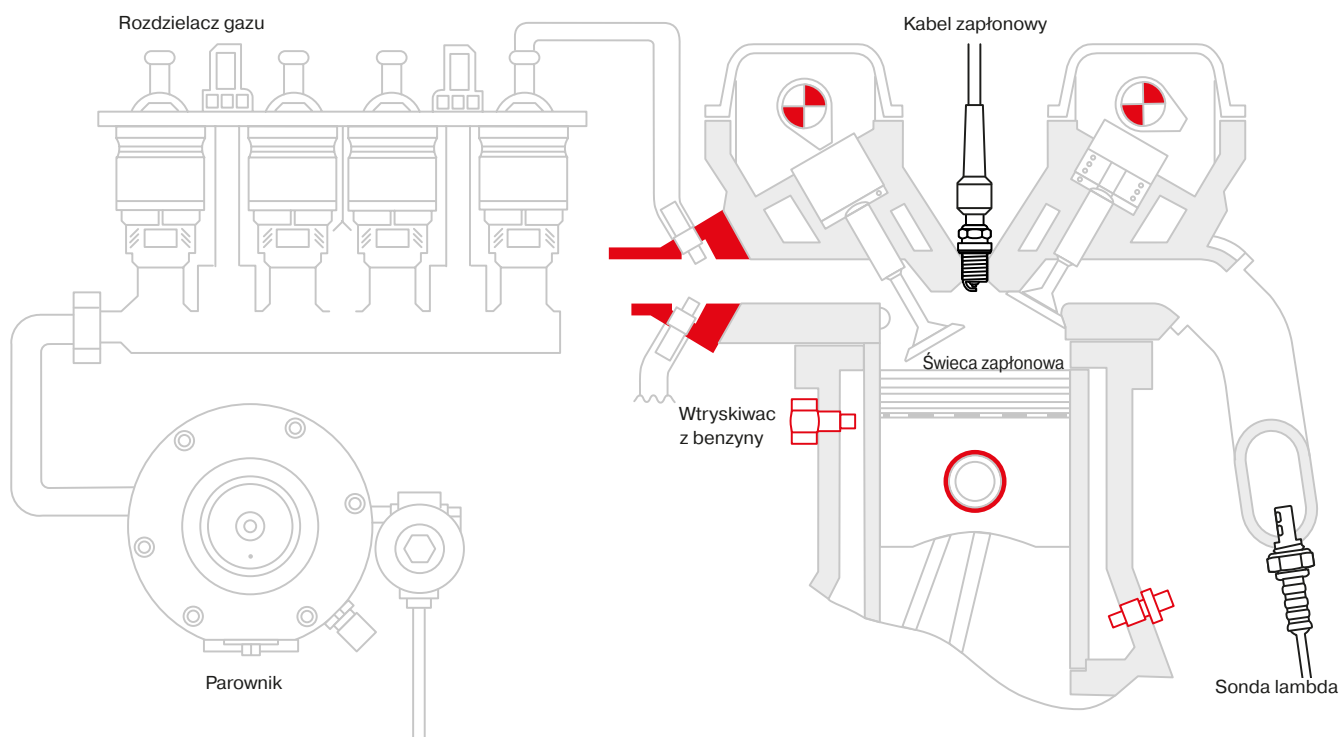



# D-POWER<sup>NGK</sup>



## D-Power: Aktualna technologia do silników wysokoprężnych w jednym asortymencie

Asortyment świec żarowych D-Power obejmuje 62 świec żarowych i stanowi idealne rozwiązanie dla prawie wszystkich zastosowań w pojazdach. Pokrywa przy tym około 90 % stanu europejskich pojazdów z silnikiem wysokoprężnym.

Świece żarowe D-Power zapewniają szybki i przyjazny dla środowiska rozruch zimnego silnika nawet przy najniższych temperaturach zewnętrznych.

Także dlatego, że oferują wiedzę czołowego dostawcy świec żarowych: Asortyment obejmuje oprócz standardowych świec żarowych z prętym metalowym i świec żarowych ceramicznych, przykładowo świece żarowe NHTC z ceramicznym elementem grzejnym, które używane są przez VW, Mercedes i Mitsubishi w produkcji seryjnej. Także świece żarowe zaawansowanego systemu szybkiego żarzenia (AQGS) stanowią część asortymentu D-Power. Ta technika została zastosowana na przykład przez Fiata w produkcji seryjnej.

Sprawdzony system skróconej numeracji NGK umożliwia dla każdego pojazdu szybkie znalezienie optymalnej świecy żarowej i w razie potrzeby ponowne jej zamówienie.

### Asortyment w skrócie:

- Pokrycie rynku w około 90 %
- Dla prawie wszystkich modeli samochodów w TecDoc.
- Szybkie wyszukanie pasującej świecy żarowej dzięki systemowi krótkiej numeracji NGK.
- Proste tworzenie zapasów i zarządzanie magazynem.
- Świece żarowe ceramiczne i z prętym metalowym w jednym asortymencie
- Dużo świec żarowych z wyposażenia oryginalnego





## Świece żarowe ceramiczne

W przeciwieństwie do świecy żarowej prętowej metalowej spirala żarowa świecy żarowej ceramicznej posiada wyjątkowo wysoką temperaturę topnienia. Otoczona jest azotynem krzemu, bardzo odpornym materiałem ceramicznym. Współpraca spirali żarowej i płaszczka ceramicznego umożliwia osiągnięcie wyższych temperatur i wyjątkowo krótkich czasów wstępnego żarzenia dzięki doskonałej przewodności ciepła. Poza tym świece żarowe ceramiczne mogą być węższe. Jest to ważne, ponieważ w nowoczesnych silnikach do dyspozycji jest niewiele miejsca. W przypadku świecy żarowej SRC (Self Regulating Ceramic - ceramicznej samoregulującej się) Ceramiczne świece żarowe samoregulujące się element grzejny składa się z ceramiki z wpięconą metalową spiralą żarową. Świeca żarowa HTC (ang. High Temperature Ceramic - ceramika wysoko temperaturowa) lub NHTC (ang. New High Temperature Ceramic - nowa ceramika wysoko temperaturowa) posiada element grzejny i grzejnik ceramiczny.

Firma NGK opracowała świece żarowe ceramiczne NHTC Ceramiczne świece żarowe wysoko temperaturowe specjalnie w celu umożliwienia producentom samochodów zachowanie norm spalin Euro 4 i Euro 5. Jednym z celów normy jest obniżenie stopnia sprężania silników wysokoprężnych. Świece żarowe NHTC osiągają w czasie krótszym od 2 sekund temperaturę 1.000 °C i mogą żarzyć się ponad 10 minut przy temperaturach do 1.350 °C . Nawet przy niskich stopniach sprężania zapewnia się optymalny zapłon. Poza tym świecę żarową NHTC można żarzyć pośrednio, aby w fazie odcięcia dopływu paliwa zapobiec wychłodzeniu filtra cząstek.

### **Ceramiczne świece żarowe: Optymalne rozwiązania techniczne**

Od ponad 20 lat producenci samochodów używają świec żarowych ceramicznych firmy NGK. Jednakże dlaczego tych świec żarowych nie można zastąpić porównywalnie korzystniejszymi świecami żarowymi metalowymi?

Odpowiedź: Naturalnie „można” dużo zrobić. Pytaniem jest tylko, jakie ryzyko można ponieść. Tam, gdzie fabrycznie zamontowane są ceramiczne świece żarowe NGK, w razie uszkodzenia należy wymienić je również na ceramiczne świece żarowe NGK. Powód: Te świece żarowe zostały specjalnie opracowane dla odpowiednich silników. Ceramiczne świece żarowe firmy NGK gwarantują długi okres użytkowania i zapewniają niezawodny i szybki zapłon nawet przy najniższych temperaturach zewnętrznych. Jednocześnie dbają o to, aby gazy spalinowe były mniej szkodliwe. Zasadniczo są one trochę droższe od metalowych świec żarowych, ale: metalowe świece żarowe w niektórych silnikach mogą stwarzać problemy z uruchomieniem w skrajnie niskich temperaturach otoczenia.

### **Wskazówka!**

W przypadku przejścia na wersję metalowe trzeba będzie wymienić wszystkie świece żarowe - także w dobrym stanie.

# Przegląd D-Power

D-Power	Typ	Stock-No.
DP 1	Y-924J	7906
DP 2	Y-918J	6285
DP 3	Y-910J	3617
DP 4	Y-732J	6001
DP 5	Y-937J	7503
DP 6	Y-916J	5906
DP 7	Y-506J	2419
DP 8	CY03	6160
DP 10	Y-503J	1009
DP 11	Y-745U	6346
DP 12	Y-516J	6416
DP 13	Y-733J	6592
DP 14	Y-748U	6649
DP 15	Y-913J	5317
DP 16	Y-925J	6848
DP 17	Y-730U	6704
DP 19	Y-927J	4916
DP 20	Y-741U	6943
DP 21	CY57	4994
DP 22	Y-740U	4818
DP 24	Y-504J	1441
DP 25	Y-933J	7947
DP 26	Y-747U	4694
DP 27	Y-524J	4520
DP 28	Y-711J	4467
DP 29	Y-928U	4389
DP 30	Y-930U	4275
DP 31	Y-501U	4187
DP 32	Y-507J	2691
DP 34	Y-729U	4119
DP 36	Y-534J	3413
DP 37	Y-523J	6298
DP 38	Y-746J	3078
DP 39	Y-701J	1566
DP 40	YE04	1684
DP 41	Y-929U	1749
DP 42	Y-541J	1983
DP 43	Y-939J	5059

D-Power	Typ	Stock-No.
DP 44	Y-531J	5467
DP 45	Y-542J	5513
DP 46	Y-543J	5618
DP 47	Y-547AS	5968
DP 48	YE14	7768
DP 49	Y-609AS	5849
DP 50	Y-607AS	7560
DP 51	Y8002AS	6287
DP 52	CZ104	9826
DP 53	CZ106	9957
DP 54	CZ303	7865
DP 55	CZ304	9864
DP 56	Y1005J	7957
DP 57	Y1002AS	8888
DP 58	Y8001AS	8904
DP 59	Y1007J	3040
DP 60	Y-603J	8838
DP 61	Y-519J	93293
DP 62	Y8003J	97256
DP 63	Y1013J	94470
DP 64	Y8005J	96853
DP 65	Y1012J	92083
DP 66	Y-517J	91766
DP 67	Y-527J	96187
DP 68	CZ203	95232
DP 69	Y-526J1	93283
DP 70	Y1030J	90828
DP 71	Y1031J	95970
DP 72	Y9001AS	97719
DP 73	YE05	91322
DP 74	Y8008AS	91440
DP 75	Y-548J	94832
DP 76	CZ251	91238
DP 77	Y1035AS	94103
DP 78	Y9003AS	94251
DP 80	Y1039AS	91648
DP 81	Y-536J	95061





# Świece zapłonowe sportowe **NGK**



# Series of NGK racing spark plugs

Blue colour indicates resistor plugs.

Thread size (Hexagon size)	Spark plug type	Spark plug number	Heat rating	Terminal nut type	Firing end	Electrode material			
						Center	Ground		
φ 14×19mm (20.8Hex)	BP-E	R4304A-	7,8,9,10		A ①	Gold Palladium	Nickel Alloy		
	B-E	R6918B-	7,8,9		B ①	Platinum	Nickel Alloy		
		R6918C-	9		B ①	Platinum	Nickel Alloy		
		R6021E-	8,9,10		B ①	Nickel Alloy	Nickel Alloy		
		R7376-	7,8,9,10		C ①	Iridium	Platinum		
		R5649-	9,10,11		E ①	Nickel Alloy	—		
		R6712-	9,10		E ①	Nickel Alloy	—		
	Short	R6179A-P	105,11		C ②	Platinum	Platinum		
φ 14×22mm (20.8Hex)	Short	R6179C-PA	105		C ②	Platinum	Platinum		
		R7376B-	9,10		C ①	Iridium	Platinum		
φ 14×22mm (16.0Hex)	Short	R7282A-※2	10,105,11		C ③	Iridium	Platinum		
φ 14×19mm (16.0Hex)	Short	R7282-※2	7,8,9,10,105,11		C ③	Iridium	Platinum		
		R7282M-※2	11,115		C ③	Iridium	Platinum		
	BK-E(ISO)※1	R6888A-	8,9,10		F ⑫	Nickel Alloy	Nickel Alloy		
		R7433-	8,9,10		A ⑤	Iridium	Nickel Alloy		
	BC-E(ISO)※1	R7434-	8,9,10		C ⑤	Iridium	Platinum		
		R7279-	10		D ⑤	Iridium	Platinum		
		R6601-	8,9,10,11		E ⑤	Nickel Alloy	—		
		R6711-	9,10		E ⑤	Nickel Alloy	—		
	BCP-E(JIS)	R7435-	8,9,10		A ④	Iridium	Nickel Alloy		
	BC-E(JIS)	R7436-	8,9,10		C ④	Iridium	Platinum		
		R5883-	9,10,11		E ④	Nickel Alloy	—		
		R6690-	9,10,11		E ④	Nickel Alloy	—		
	φ 14×26.5mm (16.0Hex)	LFR	long reach	R7437-	8,9,10		A ⑭	Iridium	Nickel Alloy
			long reach	R7438-	8,9,10		C ⑭	Iridium	Platinum
	φ 14×12.7mm(20.8Hex)	B-H	R5525-	7,8,9,10,11		B ⑦	Gold Palladium	Nickel Alloy	
			R5530-	8,9,10,11		D ⑦	Gold Palladium	Platinum	
φ 14×21.5mm(20.8Hex)	Rotary RX-7	R6725-	9,10,105,11,115		D ⑥	Platinum	Platinum		
		R7420-	9,10,105,11		D ⑥	Iridium	Platinum		
φ 14×21mm(20.8Hex)	Rotary RX-8 L	R7440A-L	9,10		C ⑮	Iridium	Platinum		
φ 14×19mm(20.8Hex)	Rotary RX-8 T	R7440B-T	10,11		C ⑮	Iridium	Platinum		
φ 12×26.5mm(16.0Hex)	LKR-E	long reach	R2556B-	8,9,10		C ⑯	Iridium	Platinum	
φ 12×26.5mm(14.0Hex)	LKAR-E	long reach	R2558A-	8,9,10		C ⑰	Iridium	Platinum	
φ 12×19mm(16.0Hex)	DC-E	R2349-	9,10,11		E ⑧	Nickel Alloy	—		
		R2525-	9,10,11		C ⑧	Platinum	Nickel Alloy		
φ 10×26.5mm(14.0Hex)	LMAR-E	long reach	R0465B-	10		E ⑱	Nickel Alloy	—	
φ 10×19mm(16.0Hex)	C-E	R0373A-	8,9,10		C ⑨	Iridium	Platinum		
		R0045G-	10,11	GAP1.4		E ⑨	Nickel Alloy	—	
		R0045J-	9,10,11,12	GAP1.1		E ⑨	Nickel Alloy	—	
		R0045Q-	10,11	GAP1.1		E ⑨	Nickel Alloy	—	
φ 10×19mm Half thread (16.0Hex)	C-EH	R0409B-	8,9,10		C ⑲	Iridium	Nickel Alloy		
φ 10×12.7mm(16.0Hex)	C-H	R0161-	9,10,11		B ⑩	Nickel Alloy	Nickel Alloy		
φ 8×19mm Half thread (13.0Hex)	E-EH	R847-	10,11		E ⑪	Nickel Alloy	—		

※ 1 ISO : The length from gasket to terminal of ISO type spark plugs is 50.5mm which is 2.5mm shorter than BCP-E or BC-E type spark plugs.

※ 2 It's necessary to use special plug caps(Please refer to page 6)

※ 3 Resistor spark plugs are recommended for cars originally equipped with resistor spark plugs.

When nonresistor spark plugs are installed in such cars, there is some possibility that the electric devices in the car, such as the audio system or the engine management system, would be affected by noise.

NOTICE) = Solid post terminal

= Thread terminal with nut

= Thread terminal



# Appearance

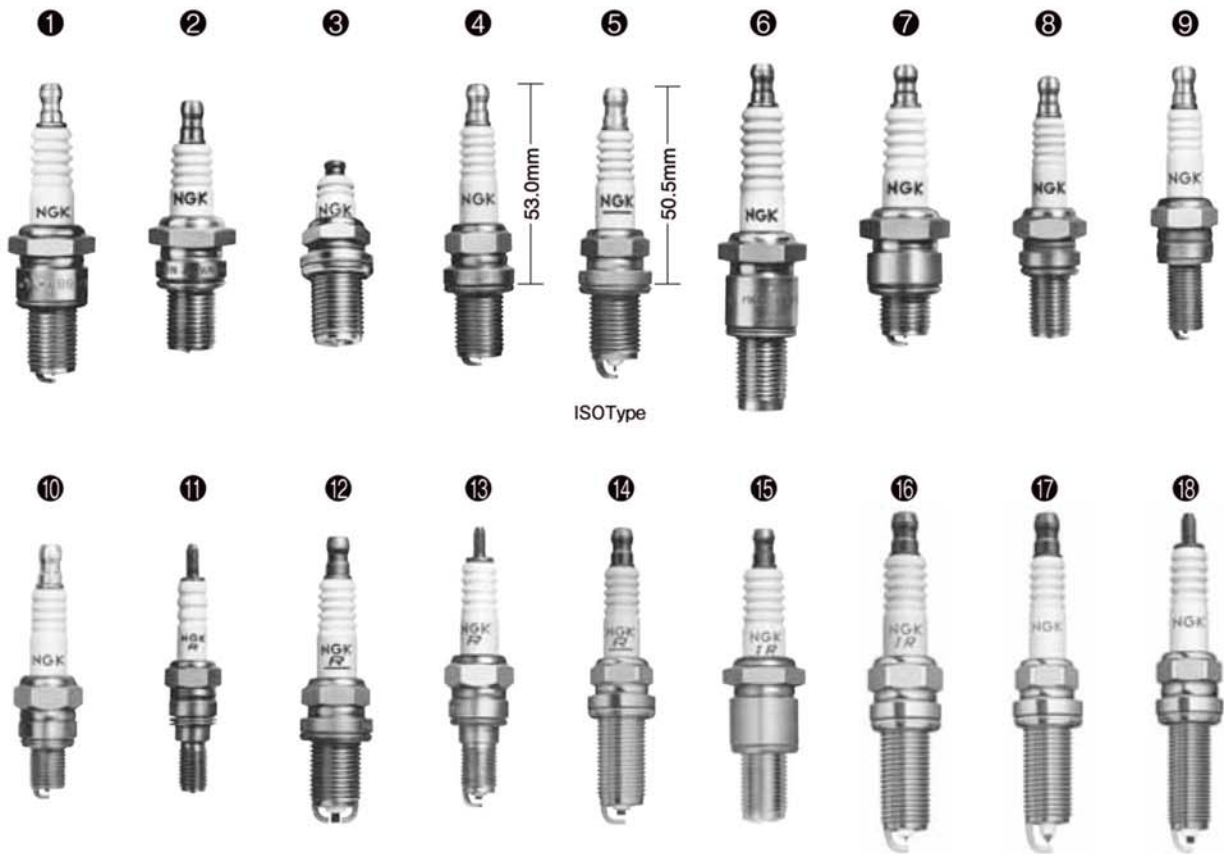

# Firing end



# Discontinued plug types

Blue colour indicates resistor plugs.

Old part number	New part number	Old part number	New part number
R016-, R017-	→ R0373A-	R5400-, R5400F-, R6337-	→ R7435-
R216-, R217-	→ R2525-	R5686-	→ R7435- or R7436-
R2270-, R2430-	→ R2349-	R5830-, R5687-	→ R7436-
R4630A-, R6385-P	→ R7376-	R7112-, R7113-	→ R7433-
R6120-	→ R7282-	R7114-, R7115-	→ R7433- or R7434-
R6120A-	→ R7282A-	R7116-, R7117-	→ R7434-
R6120C-	→ R7282C-	R7118-, R7119-	→ R7434-
R6120M-	→ R7282M-	R7232-, R7233-	→ R7435-
R6255-, R6255F-, R6326-	→ R7433-	R7234-, R7235-	→ R7435- or R7436-
R6205-, R6241-	→ R7433- or R7434-	R7236-, R7237-	→ R7436-
R6206-, R6242-	→ R7434-	R7238-, R7239-	→ R7436-

# Lokalizacja numerów silnika

Niniejsze informacje dotyczą tylko kompleksowego, oryginalnego wyposażenia producenta pojazdu.

<b>Alfa</b>	<b>tabliczka identyfikacyjna, blok silnikowy</b>
<b>Audi</b>	w książeczce serwisowej, blok silnikowy oraz: <b>A2, A3, A4, A5, A6, A8</b> miejsce na koło zapasowe, prawa strona <b>100/200</b> blacha końcowa z tyłu, wewnątrz po lewej stronie <b>Avant</b> podłoga z tyłu w środku <b>80/90, Audi V8</b> strona wewnętrzna pokrywy bagażnika <b>Audi Coupé</b> bagażnik po prawej stronie pod wkładką niecki
<b>BMW</b>	blok silnikowy
<b>Citroën</b>	na bloku silnikowym
<b>Daihatsu</b>	instrukcja obsługi, blok silnikowy
<b>Fiat</b>	tabliczka identyfikacyjna, blok silnikowy
<b>Ford</b>	blok silnikowy, tabliczka identyfikacyjna
<b>Honda</b>	blok silnikowy na przejściu do skrzyni biegów
<b>Hyundai</b>	blok silnikowy
<b>Jaguar</b>	blok silnikowy, tabliczka identyfikacyjna
<b>Kia</b>	blok silnikowy po stronie skrzyni biegów
<b>Lada</b>	blok silnikowy z lewej strony
<b>Lancia</b>	blok silnikowy, tabliczka identyfikacyjna
<b>Mazda</b>	blok silnikowy (położenie według instrukcji obsługi)
<b>Mercedes</b>	blok silnikowy
<b>Mitsubishi</b>	blok silnikowy, tabliczka identyfikacyjna na pokrywie silnika oraz w zeszytych serwisowym
<b>Nissan</b>	blok silnikowy
<b>Opel</b>	blok silnikowy na wysokości skrzyni biegów
<b>Peugeot</b>	blok silnikowy (tabliczka aluminiowa)
<b>Renault</b>	blok silnikowy (w środku) wzgl. tabliczka aluminiowa
<b>Rover</b>	blok silnikowy z przodu, prawa strona, na wysokości głowicy cylindrowej
<b>Saab</b>	blok silnikowy na dole
<b>Seat</b>	blok silnikowy, od modelu '93 jak u VW
<b>Skoda</b>	blok silnikowy obok rozdzielacza zapłonu
<b>Subaru</b>	blok silnikowy obok osłony pasa zębatego
<b>Suzuki</b>	blok silnikowy u przejścia do skrzyni biegów F = blok żeliwny G = blok aluminiowy
<b>Toyota</b>	naklejka na osłonie pasa zębatego albo pokrywie wlewu paliwa
<b>VW</b>	w książeczce serwisowej, blok silnikowy, oraz <b>Käfer/garbus:</b> blacha końcowa z przodu, lewa strona <b>Lupo, Polo, Derby,</b> <b>Golf, Scirocco, Jetta</b> <b>Passat limuzyna,</b> <b>Corrado, Vento, Bora:</b> blacha końcowa z przodu, lewa strona wewnątrz <b>Golf Cabrio:</b> belka poprzeczna za tylną ławką, lewa strona <b>Passat Variant:</b> niecka koła zapasowego, z tyłu, lewa strona <b>Transporter:</b> belka poprzeczna deski rozdzielczej, lewa strona <b>LT:</b> kolumna z lewej strony na dole <b>Ittis:</b> blacha podłogowa z lewej strony obok skrzynki apteczki <b>Taro:</b> tylna ściana kabiny, wewnątrz z lewej strony
<b>Volvo</b>	<b>seria 300, 700, 900,</b> <b>C, S i V</b> naklejka na pokrywce czołowej <b>wszystkie inne modele:</b> naklejka na pokrywce wlewu paliwa



# SERIES OF NGK SPARK PLUGS

NGK ZÜNDKERZENSERIEN

SÉRIES DES BOUGIES NGK

SERIES DE BUJÍAS DE ENCENDIDO NGK TYPBETECKNINGAR FÖR NGK TÄNDSTIFT

## STANDARD TYPES

STANDARD AUSFÜHRUNGEN  
TIPOS ESTANDARES

TYPES STANDARDS  
STANDARDTYPER

	NON-RESISTOR NON-RÉSISTANCE ICKERESISTOR	OHNE WIDERSTAND NO-RESISTOR	RESISTOR RÉSISTANCE RESISTOR	MIT WIDERSTAND RESISTOR
14mm $\phi$ $\times$ 9.5mm 20.8 Hex Fig.①①	<b>B-2</b> <b>B-4</b> <b>B6S</b> <b>B7S</b> <b>B8S</b>		<b>BR6S</b>	
Fig.①③	<b>BP-4</b> <b>BP5S</b> <b>BP6S</b>			
14mm $\phi$ $\times$ 19.0mm 20.8 Hex Fig.②①	<b>B4ES</b> <b>B5ES</b> <b>B6ES,-11</b> <b>B7ES,-11</b> <b>B8ES</b> <b>B9ES</b> <b>B10ES</b>		<b>BR4ES</b> <b>BR5ES</b> <b>BR6ES,-11</b> <b>BR7ES</b> <b>BR8ES,-11</b> <b>BR9ES</b> <b>BR10ES</b>	
Fig.②②			<b>BR6EB-L-11</b>	
Fig.②④			<b>BR8EYA</b> <b>BR9EYA</b> <b>BR10EYA</b>	
Fig.②⑤	<b>BP2ES, BP-2E</b> <b>BP4ES,-11</b> <b>BP4ES-L-11</b> <b>BP5ES,-11,-13</b> <b>BP6ES,-11</b> <b>BP7ES,-11</b> <b>BP8ES</b> <b>BP9ES</b>	<b>BP5ESZ</b> <b>BP6ESZ</b>	<b>BPR2ES, BPR-2E</b> <b>BPR4ES,-11,-13</b> <b>BPR5ES,-11,-13</b> <b>BPR6ES,-11,-13</b> <b>BPR7ES,-11</b> <b>BPR8ES</b> <b>BPR9ES</b>	
Fig.②⑥			<b>BPR5EA</b> <b>BPR5EA-L,-11</b>	
Fig.③①			<b>BPR6EKN</b> <b>BPR7EKN</b>	
Fig.②⑦	<b>BP4EY,-11</b> <b>BP5EY,-11</b> <b>BP6EY,-11</b> <b>BP7EY</b>		<b>BPR4EY,-11</b> <b>BPR5EY,-11</b> <b>BPR6EY,-11</b> <b>BPR7EY,-11</b>	
Fig.②⑧	<b>BP5E</b> <b>BP6E</b>		<b>BPR4E,-11</b> <b>BPR5E,-11</b> <b>BPR6E,-11</b> <b>BPR7E</b>	
Fig.④②	<b>BP5ET,-10</b> <b>BP6ET</b> <b>BP7ET</b>			
Fig.⑤①			<b>BPR5EJ</b>	
14mm $\phi$ $\times$ 19.0mm 16.0 Hex Fig.⑥③	<b>BCP4ES,-11</b> <b>BCP5ES,-11</b> <b>BCP6ES,-11</b> <b>BCP7ES,-11</b>		<b>BCPR4ES-11</b> <b>BCPR5ES,-11</b> <b>BCPR6ES,-11</b> <b>BCPR7ES,-11</b> <b>BCPR9ES-11</b>	
Fig.⑧② ISO	<b>BCP5ET</b> <b>BCP6ET</b> <b>BCP7ET</b>		<b>BCPR5ET</b> <b>BCPR6ET</b> <b>BCPR7ET</b>	
Fig.⑥①	<b>BC6ES</b>		<b>BCR8ES</b>	
Fig.⑦③ ISO	<b>BK5ES</b>	<b>BK5ESZ</b>	<b>BKR4ES-11</b> <b>BKR5ES,-11</b> <b>BKR6ES,-11</b> <b>BKR7ES-11</b>	

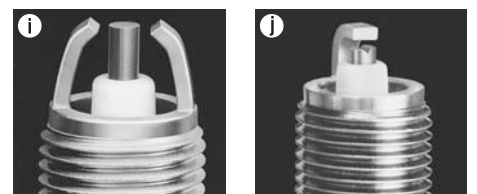
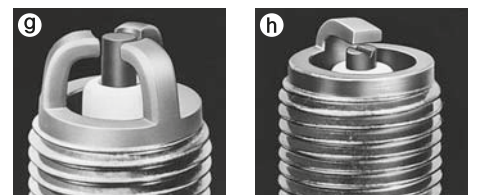
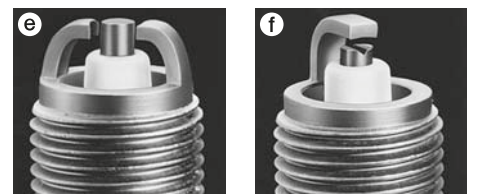
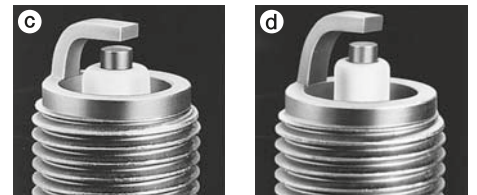
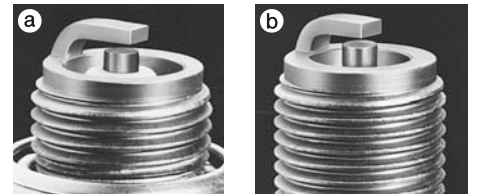
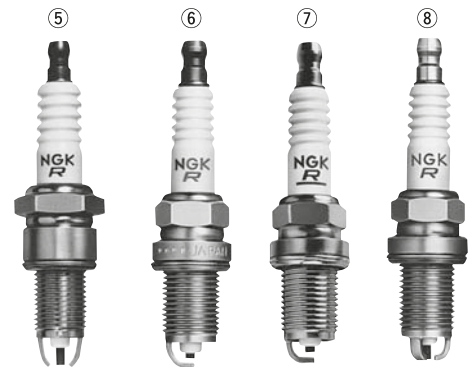
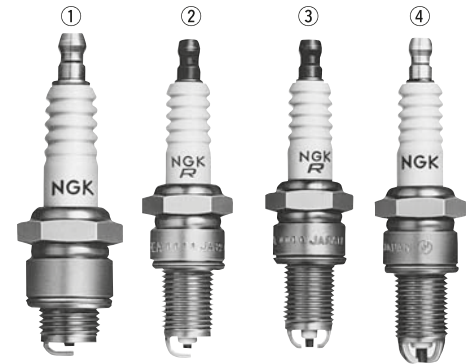

	NON-RESISTOR NON-RÉSISTANCE ICKERESISTOR	OHNE WIDERSTAND NO-RESISTOR	RESISTOR RÉSISTANCE RESISTOR	MIT WIDERSTAND RESISTOR
14mm $\phi$ $\times$ 19.0mm 16.0 Hex Fig. ①③	<b>BCP5EY-11</b>		<b>BCPR4EY-11</b> <b>BCPR5EY,-11,-N-11</b> <b>BCPR6EY,-11,-N-11</b> <b>BCPR7EY,-11,-N-11</b>	
Fig. ②③ ISO			<b>BKR4EY,-11</b> <b>BKR5EY,-11 BKR5EYA,-11</b> <b>BKR6EY,-11 BKR6EYA,-11</b> <b>BKR7EY</b>	
Fig. ①④	<b>BCP5E,-11</b> <b>BCP6E,-11</b> <b>BCP7E,-11</b>		<b>BCPR5E,-11</b> <b>BCPR6E,-11</b> <b>BCPR7E,-11</b>	
Fig. ②④ ISO	<b>BK5E,-11</b> <b>BK6E,-11</b>		<b>BKR4E,-11</b> <b>BKR5E,-11,-N,-N-11 BKR5EZ</b> <b>BKR6E,-11,-N,-N-11 BKR6EZ</b> <b>BKR7E,-11,-N-11</b> <b>BKR8E-11</b>	
Fig. ⑥⑦ ISO			<b>BKR5EK</b> <b>BKR6EK</b>	
Fig. ⑥⑨ ISO			<b>BKR5EKB-11</b> <b>BKR6EKB-11</b>	
			<b>BKR5EKC</b> <b>BKR6EKC,-N-11 BKR6EKE</b> <b>BKR7EKC,-N,-N-11</b>	
14mm $\phi$ $\times$ 26.5mm 16.0 Hex Fig. ⑧④			<b>LFR4A,-11</b> <b>LFR5A,-11</b> <b>LFR6A,-11</b>	
14mm $\phi$ $\times$ 11.2mm Conical seat 16.0 Hex Fig. ③①	<b>B7FS</b>		<b>BR5FS</b> <b>BR6FS,-15</b>	
Fig. ③②	<b>BP4FS</b> <b>BP5FS</b> <b>BP6FS</b> <b>BP7FS</b>		<b>BPR4FS,-11,-15</b> <b>BPR5FS,-11,-15</b> <b>BPR6FS</b>	
Fig. ③④	<b>BP5F</b> <b>BP6F</b>			
14mm $\phi$ $\times$ 17.5mm Conical seat 16.0 Hex Fig. ④①	<b>B6EFS</b> <b>B8EFS</b> <b>B9EFS</b>		<b>BR7EFS</b>	
Fig. ④⑤			<b>BR6EF</b> <b>BR7EF</b>	
Fig. ④②	<b>BP4EFS</b> <b>BP5EFS,-13</b> <b>BP6EFS,-13</b> <b>BP7EFS</b>		<b>BPR5EFS,-13</b> <b>BPR6EFS,-13,-15</b> <b>BPR7EFS-15</b>	
Fig. ④④	<b>BP6EF</b>		<b>BPR6EF,-11,-13</b>	
14mm $\phi$ $\times$ 25.0mm Conical seat 16.0 Hex Fig. ⑦②			<b>TR5A-13</b> <b>TR5B-13</b> <b>TR6B-10,-13</b>	
14mm $\phi$ $\times$ 11.2mm 20.8 Hex Fig. ⑤①	<b>B-4L</b> <b>B-6L B6LY(Fig. ⑤⑤)</b>			

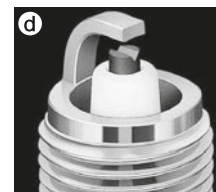
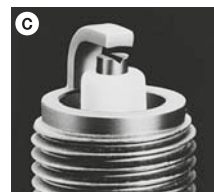
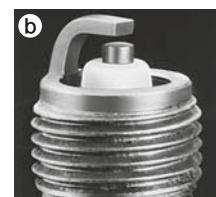
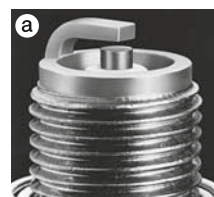
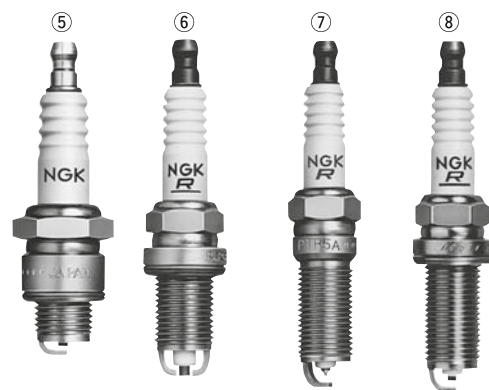
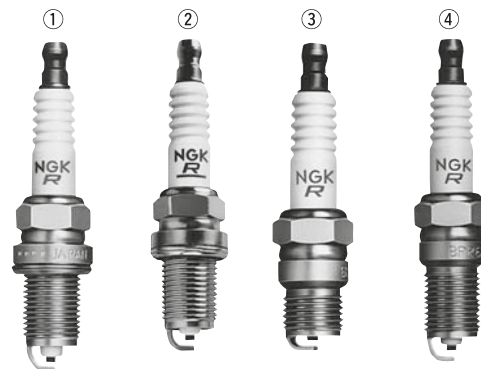

	NON-RESISTOR NON-RESISTANCE ICKERESISTOR	OHNE WIDERSTAND NO-RESISTOR	RESISTOR RESISTANCE RESISTOR	MIT WIDERSTAND RESISTOR
14mm $\phi$ $\times$ 12.7mm 20.8 Hex Fig. ①⑧	<b>B-2H</b> <b>B-4H,-10</b> <b>B5HS</b> <b>B6HS,-10</b> <b>B7HS,-10</b> <b>B8HS,-10</b> <b>B9HS,-10</b> <b>B10HS</b>		<b>BR4HS</b> <b>BR5HS</b> <b>BR6HS,-10</b> <b>BR7HS,-10</b> <b>BZ7HS-10</b> <b>BR8HS,-10</b> <b>BR9HS,-10</b>	
	Fig. ①⑨	<b>BP2HS,-10</b> <b>BP4HS,-10</b> <b>BP4HSA</b> <b>BP5HS,-10</b> <b>BP6HS,-10</b> <b>BP6HSA</b> <b>BP7HS,-10</b> <b>BP8HS,-10,-15</b> <b>BP8HSA</b>	<b>BP-2H</b> <b>BP-4H</b> <b>BP6H</b> <b>BP7H</b>	<b>BPR2HS</b> <b>BPR4HS,-10</b> <b>BPR4HSA</b> <b>BPR-4H</b> <b>BPR5HS</b> <b>BPR6HS,-10</b> <b>BPR6HSA</b> <b>BPR7HS,-10</b> <b>BPR8HS,-10</b> <b>BPR8HSA</b> <b>BPZ8HS-10,-15</b>
	Fig. ①⑩	<b>BP4HA</b> <b>BP5HA</b>		
	Fig. ①⑪	<b>B6HSA</b> <b>B8HSA</b>		<b>BR4HSA,-9</b> <b>BR6HSA,-9</b> <b>BR8HSA,-9</b>
18mm $\phi$ $\times$ 10.9mm Conical seat 20.8 Hex Fig. ④⑫	<b>A6FS</b> <b>A7FS</b> <b>A8FS</b> <b>A9FS</b>		<b>AR6FS</b>	
	Fig. ④⑬	<b>AP4FS</b> <b>AP5FS</b> <b>AP6FS</b> <b>AP7FS</b> <b>AP8FS</b> <b>AP9FS</b>		<b>APR5FS</b> <b>APR6FS</b>
	Fig. ④⑭	<b>AP6F</b>		<b>APR6F</b>
18mm $\phi$ $\times$ 12.0mm 20.8 Hex Fig. ⑤⑮	<b>AB-2</b> <b>AB-6</b> <b>AB-7</b> <b>AB-8</b>			
12mm $\phi$ $\times$ 19.0mm 18.0 Hex Fig. ⑥⑯	<b>D6EA</b> <b>D7EA</b> <b>D8EA</b> <b>D9EA</b> <b>D10EA</b>		<b>DR7EA</b> <b>DR7EB</b> <b>DR8EA</b> <b>DR8EB</b> <b>DR9EA</b>	
	Fig. ⑥⑰	<b>DP6EA-9</b> <b>DP7EA-9</b> <b>DP8EA-9</b> <b>DP9EA-9</b>		<b>DPR5EA-9</b> <b>DPR6EA-9</b> <b>DPR6EB-9</b> <b>DPR7EA-9</b> <b>DPR8EA-9</b> <b>DPR9EA-9</b>
	Fig. ⑥⑱	<b>J9A</b>		<b>JR8B</b> <b>JR9B</b> <b>JR10B</b>
	Fig. ⑥⑲			<b>JR8C</b> <b>JR9C</b>
12mm $\phi$ $\times$ 21.0mm 18.0 Hex Fig. ⑦⑳	<b>DP8Z</b>		<b>DPR7Z</b> <b>DPR8Z</b> <b>DPR9Z</b>	
12mm $\phi$ $\times$ 19.0mm 16.0 Hex Fig. ⑧㉑	<b>DCP6E</b> <b>DCP7E</b>		<b>DCPR6E</b> <b>DCPR7E</b> <b>DCPR7E-N</b> <b>DCPR8E</b> <b>DCPR8E-N</b> <b>DCPR9E</b>	
	Fig. ⑧㉒			<b>DCPR8EKC</b>
12mm $\phi$ $\times$ 26.5mm 14.0 Hex			<b>LKAR8A-9,9S</b>	

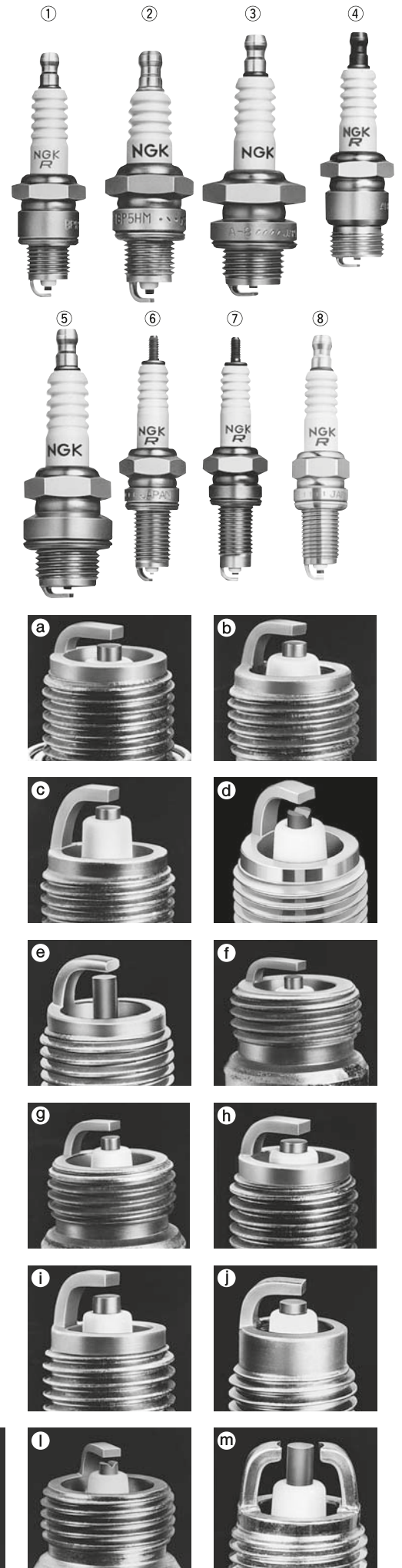



	NON-RESISTOR NON-RÉSISTANCE ICKERESISTOR	OHNE WIDERSTAND NO-RESISTOR	RESISTOR RÉSISTANCE RESISTOR	MIT WIDERSTAND RESISTOR
12mm $\phi$ $\times$ 12.7mm 18.0 Hex Fig. ①①	<b>D6HA</b> <b>D8HA</b>		<b>DR4HS</b> <b>DR5HS</b> <b>DR6HS</b> <b>DR8HS</b>	
10mm $\phi$ $\times$ 12.7mm 16.0 Hex Fig. ②①	<b>C2H</b> <b>C5HSA</b> <b>C6HSA</b> <b>C7HSA</b> <b>C8HSA</b>	<b>C4HSB</b> <b>C5HSB</b>	<b>CR4HSA</b> <b>CR5HSA</b> <b>CR6HSA</b> <b>CR7HSA</b> <b>CR8HSA</b>	<b>CR4HSB</b> <b>CR5HSB</b>   <b>LR8A</b>
10mm $\phi$ $\times$ 19.0mm 16.0 Hex Fig. ③①	<b>C7E</b> <b>C8E</b> <b>C9E</b>		<b>CR6E</b> <b>CR7E</b> <b>CR8E</b> <b>CR9E</b> <b>CR10E</b>	<b>CR7EB</b> <b>CR8EB</b> <b>CR9EB</b>
Fig. ③③			<b>CPR8E</b>	<b>CPR7EA-9</b>
10mm $\phi$ $\times$ 19.0mm 16.0 Hex Fig. ④①	<b>C7EH-9</b> <b>C8EH-9</b> <b>C9EH-9</b>		<b>CR7EH-9</b> <b>CR8EH-9</b> <b>CR9EH-9</b> <b>CR10EH-9</b>	
10mm $\phi$ $\times$ 19.0mm 16.0 Hex Fig. ③②			<b>CR7EK</b> <b>CR8EK</b> <b>CR9EK</b> <b>CR10EK</b>	<b>CR7EKB</b> <b>CR8EKB</b> <b>CR9EKB</b>
Fig. ③③			<b>CR7EKC</b>	
10mm $\phi$ $\times$ 19.0mm 14.0 Hex			<b>MAR10A-J</b>	
10mm $\phi$ $\times$ 26.5mm 14.0 Hex			<b>LMAR6A-9</b> <b>LMAR7A-9</b> <b>LMAR8A-9,9S</b>	<b>LMAR6C-9</b>
8mm $\phi$ $\times$ 19.0mm 13.0 Hex Fig. ⑤①			<b>ER8EH</b> <b>ER9EH</b> <b>ER10EH</b>	

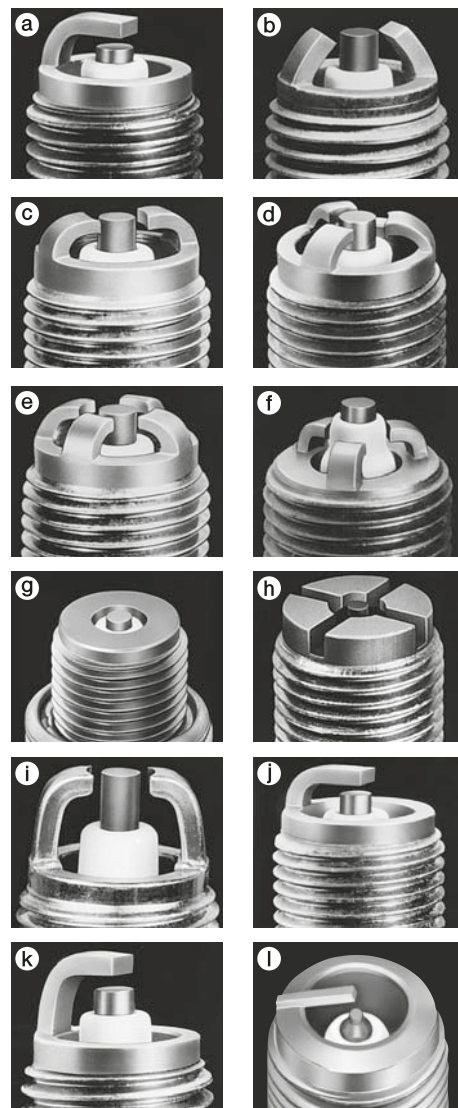

**FOR ROTARY ENGINE**  
**FÜR WANKELMOTOR**    **POUR MOTEUR ROTATIF**  
**PARA MOTOR ROTATIVO**    **TÄNDSTIFT FÜR WANKELMOTORER**

	NON-RESISTOR NON-RÉSISTANCE ICKERESISTOR	OHNE WIDERSTAND NO-RESISTOR	RESISTOR RÉSISTANCE RESISTOR	MIT WIDERSTAND RESISTOR
14mm $\phi$ $\times$ 19.5mm 20.8 Hex Fig. ⑥③	<b>B7EM</b>		<b>BR8EM</b>	
Fig. ⑥④			<b>BR7ET</b> <b>BR8ET</b> <b>BR9ET</b> <b>BR10ET</b>	
Fig. ⑥⑤			<b>BR7EQ-14</b> <b>BR8EQ,-14</b> <b>BR9EQ-14</b>	
14mm $\phi$ $\times$ 21.5mm 20.8 Hex Fig. ⑧⑨			<b>SD10A</b> <b>SD11A</b>	
Fig. ⑧⑧			<b>BUR6EQ</b> <b>BUR7EQ</b> <b>BUR8EQ</b> <b>BUR9EQ</b>	<b>BUR7EQP</b> <b>BUR9EQP</b>
14mm $\phi$ $\times$ 21.0mm 20.8 Hex Fig. ⑨			<b>RE6C-L</b> <b>RE7C-L</b> <b>RE8C-L</b>	
14mm $\phi$ $\times$ 19.0mm 20.8 Hex Fig. ⑩①			<b>RE9B-T</b>	



**SEMI SURFACE DISCHARGE TYPES**  
**HALBGLEITFUNKENTYP TYPE À DÉCHARGE**  
**TIPO DE DESCARGA DE MEDIA SUPERFICIE**  
**STIFT MED YTGNIISTGAP**

	NON-RESISTOR OHNE WIDERSTAND NON-RÉSISTANCE NO-RESISTOR ICKERESISTOR	RESISTOR MIT WIDERSTAND RÉSISTANCE RESISTOR RESISTOR
14mm $\phi$ $\times$ 12.7mm 20.8 Hex Fig. ① a	<b>BU8H</b>	<b>BUZ8H</b>
14mm $\phi$ $\times$ 19.0mm 20.8 Hex Fig. ② b	<b>BU6EA-11</b>	<b>BUR5EA-11 BUR6EA-11 BUR7EA-11</b>
14mm $\phi$ $\times$ 19.0mm 20.8 Hex Fig. ② c		<b>BUR4EB-11 BUR5EB-11 BUR6EB-11 BUR7EB-11</b>
	Fig. ② d	<b>BUR5ET,-10 BUR6ET</b>
14mm $\phi$ $\times$ 19.0mm 20.8 Hex Fig. ③ e	<b>BP5EK-A BP6EK-A</b>	<b>BPR5EK-A BPR6EK-A</b>
	Fig. ③ f	<b>BPR5EKU</b>
14mm $\phi$ $\times$ 17.5mm Conical seat 16.0 Hex Fig. ④ g	<b>BU6EFSZ</b>	<b>BUR6EFSZ</b>
14mm $\phi$ $\times$ 19.0mm 16.0 Hex Fig. ⑥ e ISO		<b>BKUR6EK,-9 BKUR7EK</b>
	Fig. ⑤ d ISO	<b>BKUR5ET,-10 BKUR5ETZ-10 BKUR6ET,-10 BKUR6ETB BKUR7ET</b>
	Fig. ⑥ f ISO	<b>BKR5EKU BKR6EKU BKR7EKU</b>
		<b>BKR6EKUE</b>
	Fig. ⑥ h ISO	<b>BKR6EKUB</b>
14mm $\phi$ $\times$ 22.0mm 16.0 Hex Fig. ⑦ i		<b>BKR5EKUC BKR6EKUC</b>
14mm $\phi$ $\times$ 19.0mm 16.0 Hex Fig. ⑥ j		<b>BKR6EQUA</b>

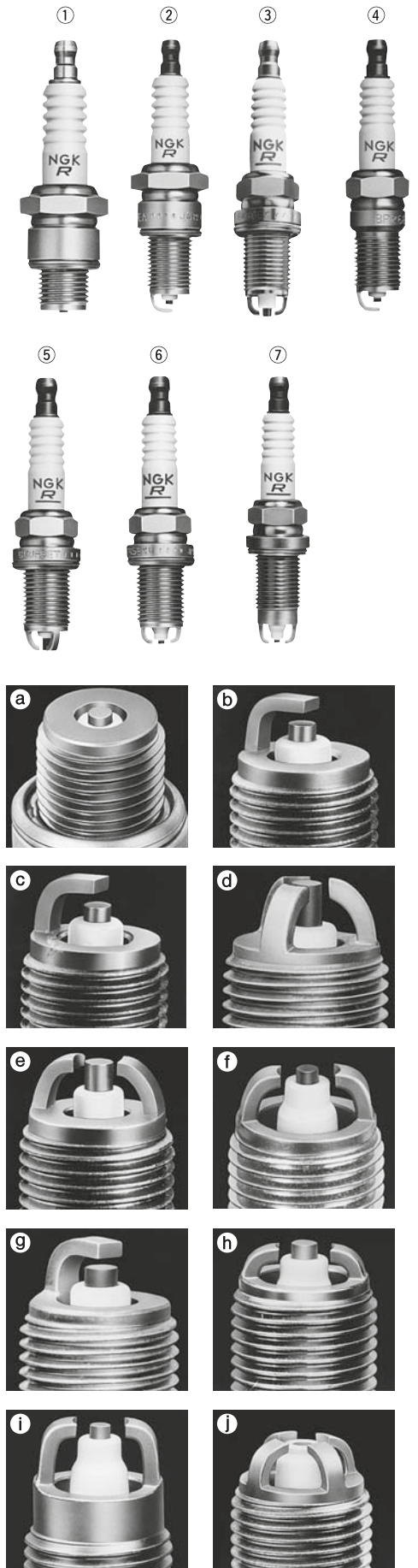

**PROJECTED GAP TYPES**  
**ZUNDKERZEN MIT VORSRINGENDER FUNKENSTRECK**  
**TYPE A ÉCARTEMENT EN SAILLIE**  
**TIPOS DE ABERTURA DE CHISPA PROYECTADA**  
**STIFT MED FÖRLÅNGDA ELEKTRODER**

	NON-RESISTOR NON-RÉSISTANCE ICKERESISTOR	OHNE WIDERSTAND NO-RESISTOR	RESISTOR RÉSISTANCE RESISTOR	MIT WIDERSTAND RESISTOR
14mm $\phi$ $\times$ 19.0mm 20.8 Hex Fig. ①(a) Fig. ②(b)	<b>BE527Y-11</b> <b>BE529Y-11</b>		<b>BRE527Y-11</b> <b>BRE529Y,-11</b>	<b>ZGR4A</b> <b>ZGR5A</b>
14mm $\phi$ $\times$ 26.0mm 20.8 Hex Fig. ②(d)	<b>ZG5D-11</b>			
14mm $\phi$ $\times$ 20.5mm 20.8 Hex Fig. ②(b)			<b>ZGR5B,-11</b> <b>ZGR6B-11</b>	
14mm $\phi$ $\times$ 22.0mm 20.8 Hex Fig. ②(c)			<b>ZGR5C</b>	
14mm $\phi$ $\times$ 19.0mm 16.0 Hex Fig. ③(b)	<b>ZF6A-11</b>		<b>ZFR5A-11</b> <b>ZFR6A-11</b>	
		Fig. ④(b) ISO	<b>ZFR4F-11</b> <b>ZFR5F,-11</b> <b>ZFR6F-11,G</b> <b>ZFR7F,-11</b>	
		Fig. ④(b) ISO	<b>ZFR5J-11</b> <b>ZFR6J-11</b> <b>ZFR7J-11</b>	
Fig. ③(a)		<b>BCRE527Y</b>		
14mm $\phi$ $\times$ 20.5mm 16.0 Hex Fig. ③(e)			<b>ZFR6K-11S</b>	
			<b>ZFR5G</b> <b>ZFR6G</b>	
14mm $\phi$ $\times$ 22.5mm 16.0 Hex Fig. ③(c)			<b>ZFR4E-11</b> <b>ZFR5E-11</b> <b>ZFR6E-11</b>	
	Fig. ③(d)		<b>ZFR5D-11</b> <b>ZFR6D-11</b>	
14mm $\phi$ $\times$ 25.0mm Conical seat 16.0 Hex Fig. ⑤(b)			<b>LZTR4A-11</b> <b>LZTR5A-13</b>	

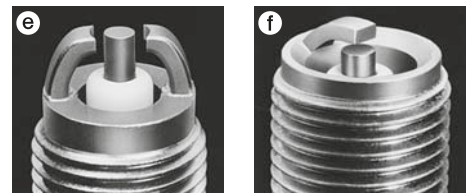
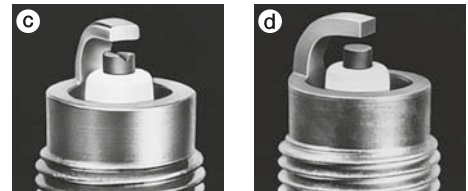
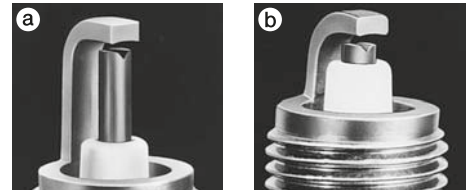
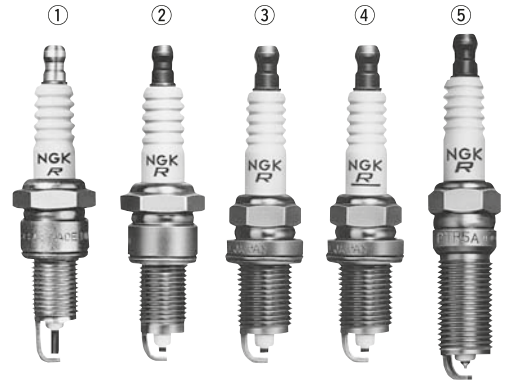

**COMPETITION TYPES**  
**WETTBEWERBS-TYPEN** **TYPES COMPÉTITION**  
**TIPOS DE COMPETICIÓN** **RACERSTIFT**

14mm $\phi$ $\times$ 12.7mm 20.8 Hex Fig. ⑥(f)	<b>B7HCS</b> <b>B8HCS</b> <b>B9HCS</b>	<b>BR8HCS-10</b>
14mm $\phi$ $\times$ 19.0mm 20.8 Hex Fig. ⑦(f)	<b>B7ECS</b> <b>B8ECS</b> <b>B9ECS</b>	<b>BR8ECS</b> <b>BR9ECS</b> <b>BR10ECS</b>
	Fig. ⑧(f)	<b>BR8ECM</b> <b>BR9ECM</b> <b>BR10ECM</b>

**PLATINUM, IRIIDIUM TIPPED TYPES**  
**TYPEN MIT PLATINELEKTRODENSPITZE, IRIIDIUMSPITZE**  
**TYPE[S] À EXTREMITÉ EN PLATINE, IRIIDIUM**  
**TIPOS CON PUNTA DE PLATINO, IRIIDIO**  
**STIFT MED MITTELEKTRODÄNDA AV PLATINA OCH IRIIDIUM**

	RESISTOR MIT WIDERSTAND RÉSISTANCE RESISTOR RESISTOR
14mm $\phi$ $\times$ 19.0mm 20.8 Hex Fig.①①	PGR5A,-11 PGR5C-11 BPR5EP-11,-13 PGR6A,-11 PGR6C-11 BPR6EP-8 PGR7A,-11  IGR7A
14mm $\phi$ $\times$ 19.0mm 20.8 Hex Fig.①h	IGR5C13
14mm $\phi$ $\times$ 19.0mm 16.0 Hex Fig.②a	PFR5A-11 PFR5K-11 BCPR5EP-8,-11,-13 PFR6A-11 PFR6H-10 PFR6K-11 BCPR6EP-8,N-8,-11,-N-11,-13 PFR7A-11 PFR7H-10
Fig.③h ISO	FR4AP-10,-11 FR4BP-11 FR5AP-10,-11 FR5BP-11 FR5AP-11E FR6AP-10,-11 FR6BP-11 FR7AP-11  FR5EI-13  PFR4B-11 PFR4C-11 PFR5B,-9,-11,-11B PFR5C-11 PFR6B,-9,-11,-11B,-11C PFR6C-11 PFR6E-10 PFR7B,-9,-11,-11C PFR8B,-9  PFR4G-11 PFR5G-11,-13E PFR5J-11 PFR6G,-9,-11,-13,-13E PFR6H-10 PFR6J,-11 PFR7G,-9,-11  PFR5L-11 PFR5N-11 PFR4P PFR6L-11,-13 PFR6N-11 PFR5P,-11 PFR7N-D PFR6P,-11 PFR6Q PFR7Q  PFR5R-11  BKR5EP-8,-11 BKR6EP-8,-11,-13,-N-8
Fig.④c ISO	BKR6EKPA
Fig.④d ISO	BKR5EKUP
Fig.④e ISO	BKR5EKPB-11,-13 BKR6EKPB-11
Fig.④j ISO	BKR5EQUPA BKR6EQUP BKR6EQUPA
Fig.③f ISO	PFR6M PFR7M
Fig.③g ISO	PZFR5B PZFR5F,-11,-13 PZFR6B PZFR6F,-11 PZFR7F
Fig.③h ISO	IFR5A11,-8N IFR5D10 IFR5E11 IFR6A11 IFR6C IFR6D10 IFR6E11  IFR5G11 IFR5J11 IFR5N10 IFR6S IFR5T-8N,11 IFR6J11 IFR6T11  IFR7F-D
Fig.②g	IZFR5B IZFR5F11 IZFR6B IZFR6F11  ZFR5LP-13G
14mm $\phi$ $\times$ 22.0mm 16.0 Hex Fig.⑩k ISO	PZFR5C PZFR5D-11
Fig.⑩k ISO	IZFR5C IZFR7E-D
14mm $\phi$ $\times$ 25.0mm conical seat 16.0 Hex Fig.⑥h	PTR5A-13



	RESISTOR MIT WIDERSTAND RÉSISTANCE RESISTOR RESISTOR
14mm $\phi$ $\times$ 17.5mm conical seat 16.0 Hex Fig. ⑨①	<b>PTR4B-15 PTR5C-13,-15</b> <b>ITR4A15 ITR5F13</b> <b>ITR6F13</b>
14mm $\phi$ $\times$ 17.5mm conical seat 16.0 Hex Fig. ③⑧	<b>PTR5D-10,-13</b> <b>PTR6D-13,-13G</b>
Fig. ⑨⑨	<b>PZTR5A-15</b>
14mm $\phi$ $\times$ 20.5mm 16.0 Hex Fig. ③②	<b>IZFR6K11,11E,13</b> <b>IZFR6K-11S,IZFR6K11NS</b>
14mm $\phi$ $\times$ 21.5mm 16.0 Hex Fig. ①③	<b>PZFR5N-11T</b>
14mm $\phi$ $\times$ 22.0mm 16.0 Hex Fig.	<b>PZFR6J-11</b>
14mm $\phi$ $\times$ 26.5mm 16.0 Hex Fig. ①④	<b>PLFR4A-11</b> <b>PLFR5A-9,-11</b> <b>PLFR6A-9,-11</b> <b>PLFR7A-9</b>
Fig. ①⑤	<b>ILZFR6A11</b>
14mm $\phi$ $\times$ 29.5mm 16.0 Hex Fig. ①⑥	<b>LZFR5AQP</b>
14mm $\phi$ $\times$ 25.0mm conical seat 16.0 Hex	<b>PLZTR4A-13,PLZTR5A-13</b>
12mm $\phi$ $\times$ 19.0mm 18.0 Hex Fig. ⑤⑧	<b>PJR6A</b> <b>PJR7A</b> <b>PJR8A</b>
	<b>IJR7A9</b>
12mm $\phi$ $\times$ 19.0mm 16.0 Hex Fig. ⑦①	<b>PKR7A</b> <b>PKR9B</b>
12mm $\phi$ $\times$ 19.0mm 16.0 Hex Fig. ⑦②	<b>DCPR8EKP</b>
12mm $\phi$ $\times$ 22.0mm 16.0 Hex Fig.	<b>IZKR7A</b>
12mm $\phi$ $\times$ 28.0mm 16.0 Hex	<b>ILZKR7B11</b> <b>ILZKR7B-11S</b> <b>ILZKR7B11GS</b>
10mm $\phi$ $\times$ 19.0mm 16.0 Hex Fig. ⑧①	<b>PMR7A</b> <b>PMR8A PMR8B</b>
10mm $\phi$ $\times$ 19.0mm 16.0 Hex Fig. ⑩	<b>IMR9C-9H</b> <b>IMR9C-9HE,IMR9C-9HES</b>
12mm $\phi$ $\times$ 26.5mm Bi-Hex 14.0mm	<b>ILZKBR7A-8G PLZKBR7A-G</b>

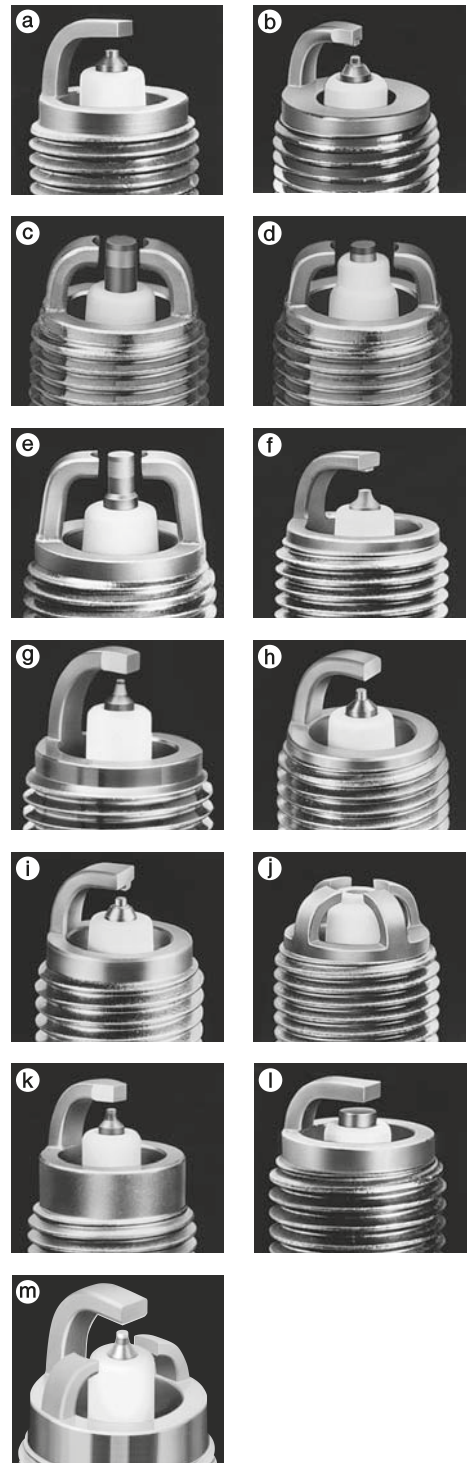



## COMPACT TYPES

KOMPAKT STIFT  
TIPOS COMPACTOS

TYPES CMPACTES  
KOMPACTE TYPEN

	NON-RESISTOR NON-RÉSISTANCE ICKERESISTOR	OHNE WIDERSTAND NO-RESISTOR	RESISTOR RÉSISTANCE RESISTOR	MIT WIDERSTAND RESISTOR
14mm $\phi$ $\times$ 9.5mm 19.0 Hex Fig. ①(a)	<b>BM4A</b> <b>BM6A</b> <b>BM7A</b>	<b>B2-LM*</b> <b>B4-LM*</b> <b>BM6*</b> <b>BM7*</b> *Hex.20.8mm	<b>BMR2A,-10</b> <b>BMR4A</b> <b>BMR6A</b> <b>BMR7A</b>	<b>BR2-LM*</b> <b>BR4-LM*</b>  *Hex.20.8mm
Fig. ①(b)	<b>BPM4A,-10</b> <b>BPM6A,-10</b> <b>BPM7A</b>		<b>BPMR4A,-10</b> <b>BPMR6A,-10</b> <b>BPMR7A,-9</b>	
14mm $\phi$ $\times$ 12.7mm 20.8 Hex Fig. ②(a)	<b>BL-6H</b>			
14mm $\phi$ $\times$ 7.8mm Conical seat 16.0 Hex Fig. ③(a)	<b>BM6F</b> <b>BM7F</b>	<b>BM6FY</b>	<b>BMR6F</b>	
Fig. ③(b)	<b>BPM6F</b> <b>BPM7F</b>		<b>BPMR6F</b>	
10mm $\phi$ $\times$ 8.6mm 14.0 Hex Fig. ④(a)	<b>CM-6</b>			
10mm $\phi$ $\times$ 9.5mm 16.0 Hex Fig. ⑧(a)			<b>CMR6A</b> <b>CMR7A</b>	
10mm $\phi$ $\times$ 12.7mm 16.0 Hex Fig. ⑧(e)			<b>CMR5H</b> <b>CMR6H</b> <b>CMR7H</b>	
14mm $\phi$ $\times$ 9.5mm 19.0 Hex Fig. ①(c)	<b>BPM6Y</b> <b>BPM7Y</b> <b>BPM8Y</b>		<b>BPMR6Y</b>  <b>BPMR8Y</b>	

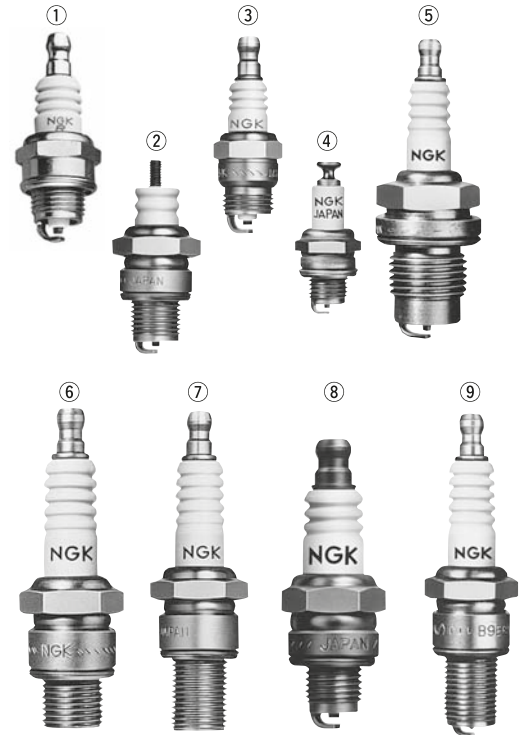

## FARM EQUIPMENT TYPES

LANDMASCHINEN TYPEN  
TIPOS MÁQUINAS AGRÍCOLAS

TYPES MACHINES AGRICOLES  
FÖR JORDBRUKS-MASKINER

PF1/2" $\times$ 22.5mm 23.8 Hex Fig. ⑤(d)	<b>G-27</b> <b>G-2Z</b>
---	----------------------------

## SURFACE DISCHARGE TYPES

GLEITFUNKENTYPEN

TYPE À DÉCHARGE SUPERFICIELLE

TIPO DESCARGA EN SUPERFICIE

TÅNDSTIFT MED YTGNIKTGAP

14mm $\phi$ $\times$ 12.7mm 20.8 Hex Fig. ⑥(f)	<b>BUHX(Series gap)</b> <b>BUHXW-1(Series gap)</b>	
	<b>BUH</b>	
	<b>BUHW</b> <b>BUHW-2</b>	<b>BUZHW</b> <b>BUZHW-2</b>
14mm $\phi$ $\times$ 19.0mm 20.8 Hex Fig. ⑦(f)	<b>BUE</b>	

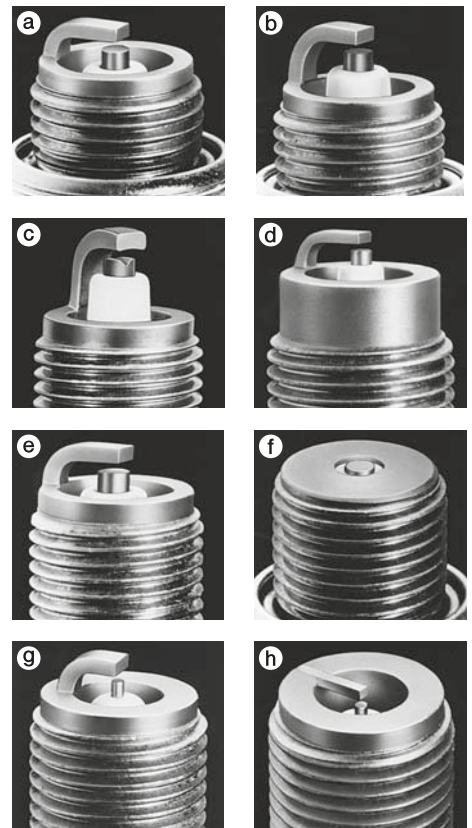

## RACING TYPES

RENN-TYPEN

TYPES COURS

TIPOS DE CARRERAS

RACERSTIFT

	Nickel electrode Nickel Elektrode Electrodo de nickel Electrodo de níquel Nickel elektrod	Precious metal electrode Elektrode mit sonde-redel metall Electrode en metal precieux Electrodo de metal precioso Adelmetall elektrod	Platinum electrode Platinel Ektrode Electrode de platine Electrodo de platino Platina elektrod
14mm $\phi$ $\times$ 19.0mm 20.8 Hex	<b>B8EG</b> Fig. ⑨(g) <b>B9EG</b> BR8EG* <b>B10EG</b> BR9EG* <b>B11EG</b> BR10EG*	<b>B8EGV</b> Fig. ⑨(g) <b>B85EGV</b> <b>B9EGV</b> <b>B95EGV</b> <b>B10EGV</b> <b>B105EGV</b> <b>B11EGV</b>	<b>B8EGP</b> Fig. ⑨(h) <b>B85EGP</b> <b>B9EGP</b> <b>B95EGP</b> <b>B10EGP</b>
*Resistor Type			

# IX TYPES

IX TYPEN  
TIPOS IX

TYPES IX  
IX-STIFT

	RESISTOR RÉSISTANCE RESISTOR	MIT WIDERSTAND RESISTOR
18mm $\phi$ $\times$ 10.9mm 20.8 Hex Fig. ①(a)	<b>WR5IX</b>	
14mm $\phi$ $\times$ 19.0mm 20.8 Hex Fig. ②(b)	<b>BPR5EIX, -11</b> <b>GR4IX</b> <b>BPR6EIX, -11</b> <b>GR5IX</b> <b>BPR7EIX</b> <b>BPR8EIX</b> <b>BPR9EIX</b>	
	Fig. ②(c)	<b>BR7EIX</b> <b>BR8EIX</b> <b>BR9EIX</b> <b>BR10EIX</b>
	Fig. ②(d)	<b>BR8ECSIX</b> <b>BR9ECSIX, -5</b>
	Fig. ③(d)	<b>BR8ECMIX</b> <b>BR9ECMIX</b> <b>BR10ECMIX</b>
14mm $\phi$ $\times$ 12.7mm 20.8 Hex Fig. ④(b)	<b>BPR6HIX</b> <b>BPR7HIX</b> <b>BPR8HIX</b>	
	Fig. ④(c)	<b>BR6HIX</b> <b>BR7HIX</b> <b>BR8HIX</b> <b>BR9HIX</b> <b>BR10HIX</b>
14mm $\phi$ $\times$ 9.5mm 20.8 Hex Fig. ⑤(a)	<b>XR4IX</b> <b>XR5IX</b> <b>XR45IX</b>	
14mm $\phi$ $\times$ 19.0mm 16.0 Hex Fig. ⑥(b)	<b>BCPR7EDIX</b>	
	Fig. ⑦(b)	<b>BCPR5EIX, -11</b> <b>BCPR6EIX, -11</b> <b>BCPR7EIX, -11</b>
	Fig. ⑧(b)	<b>BKR4EIX</b> <b>BKR5EIX, -11</b> <b>BKR6EIX, -11</b> <b>BKR7EIX, -11</b> <b>BKR8EIX</b> <b>BKR9EIX</b>
Fig. ⑧(e)	<b>ZFR5FIX-11</b> <b>ZFR6FIX-11</b>	
14mm $\phi$ $\times$ 26.5mm 16.0 Hex Fig. ⑨(b)	<b>LFR5AIX-11</b> <b>LFR6AIX-11</b> <b>LFR7AIX</b>	
14mm $\phi$ $\times$ 17.5mm Conical seat 16.0 Hex Fig. ⑩(b)	<b>BPR6EFIX-10, -15</b>	
	Fig. ⑩(a)	<b>TR4IX</b> <b>TR55IX</b> <b>TR5IX</b> <b>TR65IX</b> <b>TR6IX</b> <b>TR75IX</b> <b>TR7IX</b> <b>TR85IX</b> <b>TR8IX</b> <b>TR85IX</b>
14mm $\phi$ $\times$ 20.5mm Conical seat    16.0 Hex Fig. ⑪(e)	<b>TR5-1IX</b> <b>TR45-1IX</b> <b>TR55-1IX</b>	
14mm $\phi$ $\times$ 11.2mm Conical seat 16.0 Hex Fig. ⑫(c)	<b>YR5IX</b> <b>YR55IX</b>	
	Fig. ⑫(a)	<b>BR6FIX</b> <b>UR4IX</b> <b>UR45IX</b> <b>UR5IX</b> <b>UR55IX</b> <b>UR6IX</b>
14mm $\phi$ $\times$ 25.0mm Conical seat 16.0Hex Fig. ⑬(b)	<b>LTR5IX-11</b> <b>LTR6IX-11</b> <b>LTR7IX-11</b>	
	Fig. ⑬(e)	<b>LZTR4AIX-11</b> <b>LZTR5AIX-13</b> <b>LZTR6AIX-13</b> <b>LZTR7AIX-13</b>

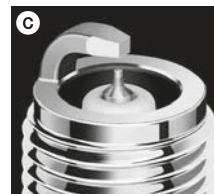
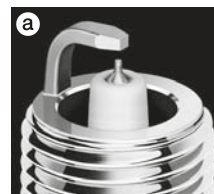
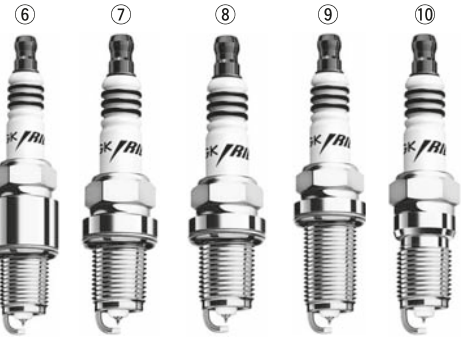

# IX TYPES

IX TYPEN      TYPES IX  
 TIPOS IX      IX-STIFT

	RESISTOR      MIT WIDERSTAND RÉSISTANCE      RESISTOR RESISTOR
12mm $\phi$ $\times$ 19.0mm 16.0 Hex Fig. ① a	<b>DCPR6EIX</b> <b>DCPR7EIX</b> <b>DCPR8EIX</b> <b>DCPR9EIX</b>
Fig. ① b	<b>DCR7EIX</b> <b>DCR8EIX</b> <b>DCR9EIX</b>
12mm $\phi$ $\times$ 19.0mm 18.0 Hex Fig. ② a	<b>DPR7EIX-9</b> <b>DPR8EIX-9</b> <b>DPR9EIX-9</b>
Fig. ② b	<b>DR7EIX</b> <b>DR8EIX</b> <b>DR9EIX</b>
12mm $\phi$ $\times$ 21.0mm 18.0 Hex Fig. ③ a	<b>DPR8ZIX</b>
12mm $\phi$ $\times$ 26.5mm Conical seat 14.0 Hex Fig. ④ d	<b>ZNAR7AIX</b> <b>ZNAR6AIX-11</b>
10mm $\phi$ $\times$ 19.0mm 16.0 Hex Fig. ⑤ a	<b>CPR7EAIX-9</b>
Fig. ⑤ c	<b>CR7EIX</b> <b>CR8EIX</b> <b>CR9EIX</b> <b>CR10EIX</b>
Fig. ⑥ b	<b>CR8EHIX-9</b> <b>CR9EHIX-9</b>
10mm $\phi$ $\times$ 12.7mm 16.0 Hex Fig. ⑦ b	<b>CR5HIX</b> <b>CR6HIX</b> <b>CR7HIX</b> <b>CR8HIX</b> <b>CR9HIX</b>
8mm $\phi$ $\times$ 19.0mm 13.0 Hex Fig. ⑧ e	<b>ER8EHIX</b> <b>ER9EHIX</b>

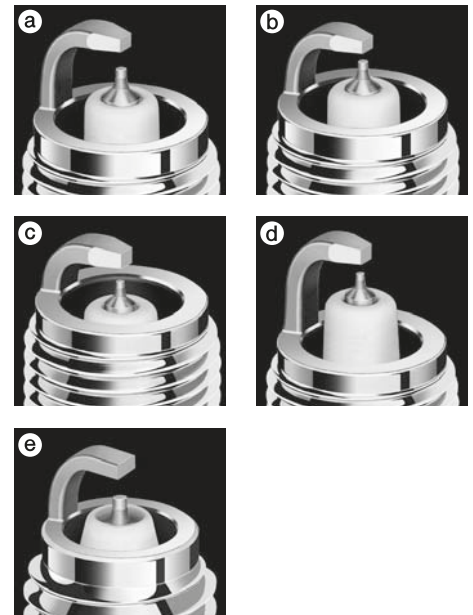
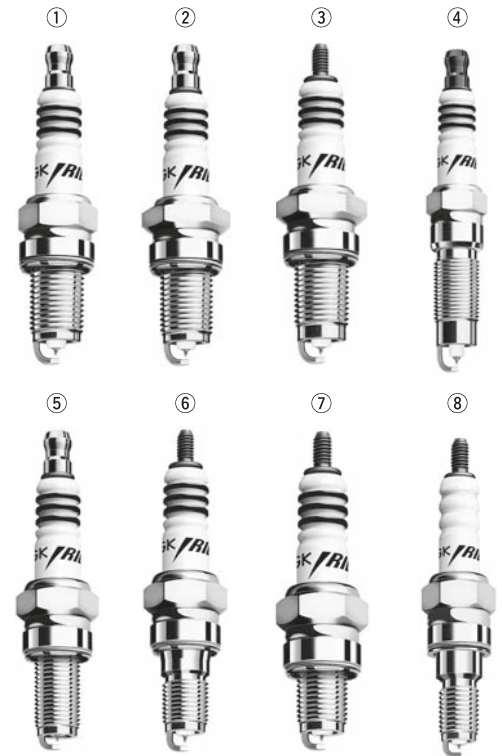

# SERIES OF NGK GLOW PLUGS

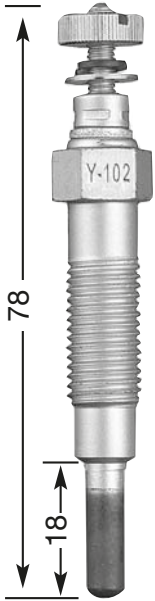

**Y-102**  
M 10 x 1.25  
12 Hex  
10,5 V

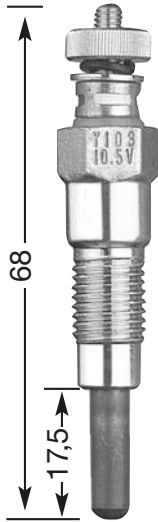

**Y-103**  
M 10 x 1.25  
12 Hex  
10,5 V

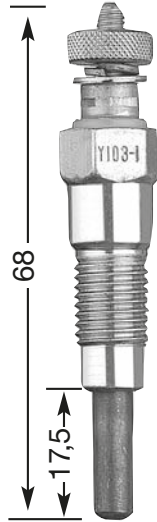

**Y-103-1**  
M 10 x 1.25  
12 Hex

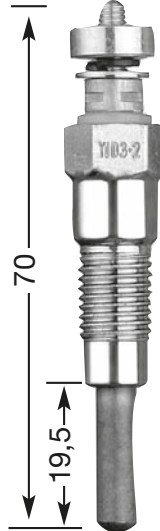

**Y-103-2**  
M 10 x 1.25  
12 Hex

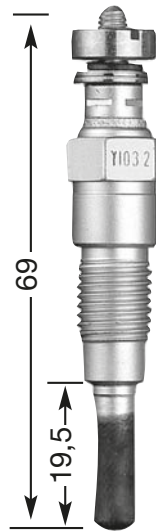

**Y-103-2A**  
M 10 x 1.25  
12 Hex

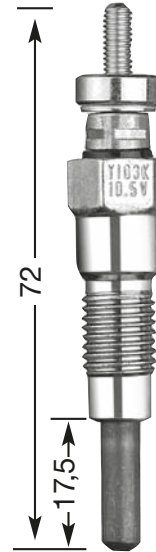

**Y-103 K**  
M 10 x 1.25  
12 Hex  
10,5 V

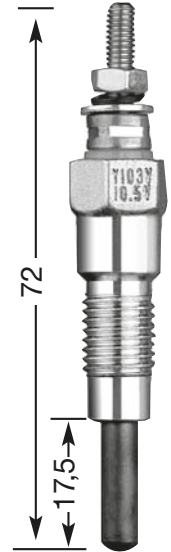

**Y-103 V**  
M 10 x 1.25  
12 Hex  
10,5 V

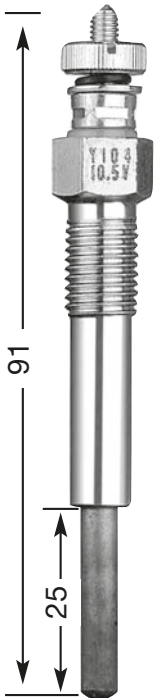

**Y-104**  
M 10 x 1.25  
12 Hex  
10,5 V



**Y-106-1**  
M 10 x 1.25  
12 Hex  
10,5 V

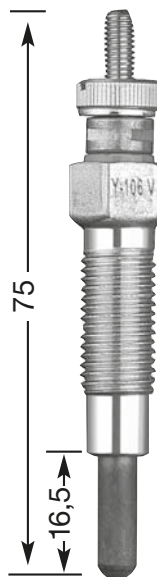

**Y-106 V**  
M 10 x 1.25  
12 Hex  
10,5 V

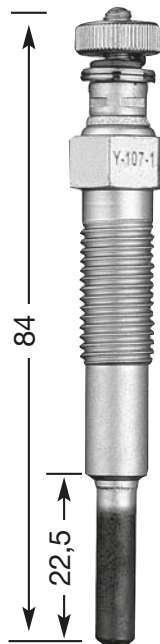

**Y-107-1**  
M 10 x 1.25  
12 Hex  
10,5 V

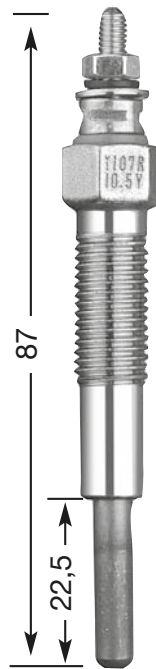

**Y-107 R**  
M 10 x 1.25  
12 Hex  
10,5 V

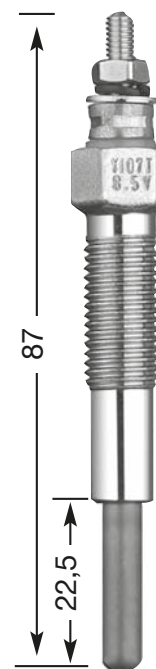

**Y-107 T**  
M 10 x 1.25  
12 Hex  
8,5 V

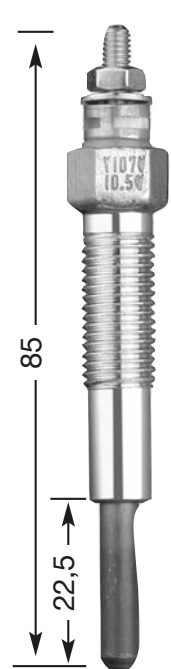

**Y-107 V**  
M 10 x 1.25  
12 Hex  
10,5 V



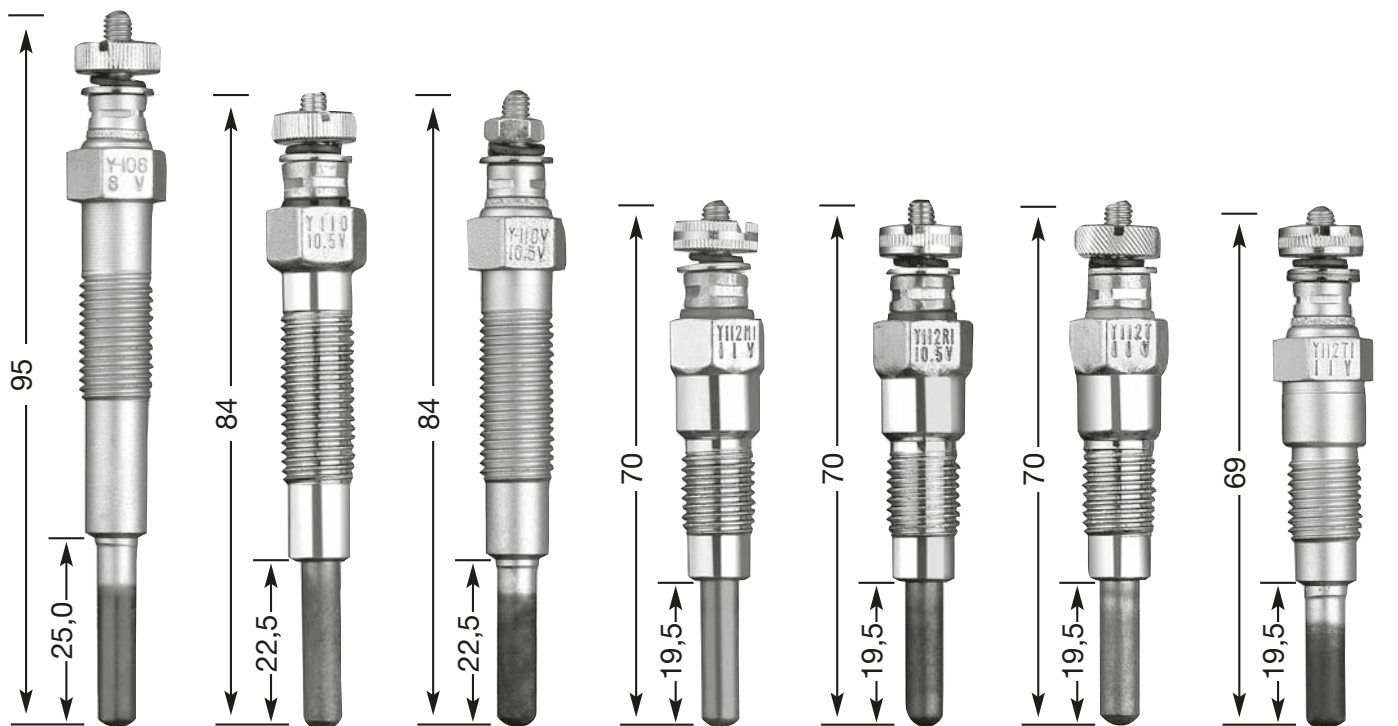

**Y-108**  
M 10 x 1.25  
12 Hex  
8 V

**Y-110**  
M 10 x 1.25  
12 Hex  
10,5 V

**Y-110 V**  
M 10 x 1.25  
12 Hex  
10,5 V

**Y-112 M1**  
M 10 x 1.25  
12 Hex  
11 V

**Y-112 R1**  
M 10 x 1.25  
12 Hex  
10,5 V

**Y-112 T**  
M 10 x 1.25  
12 Hex  
11 V

**Y-112 T1**  
M 10 x 1.25  
12 Hex  
11 V

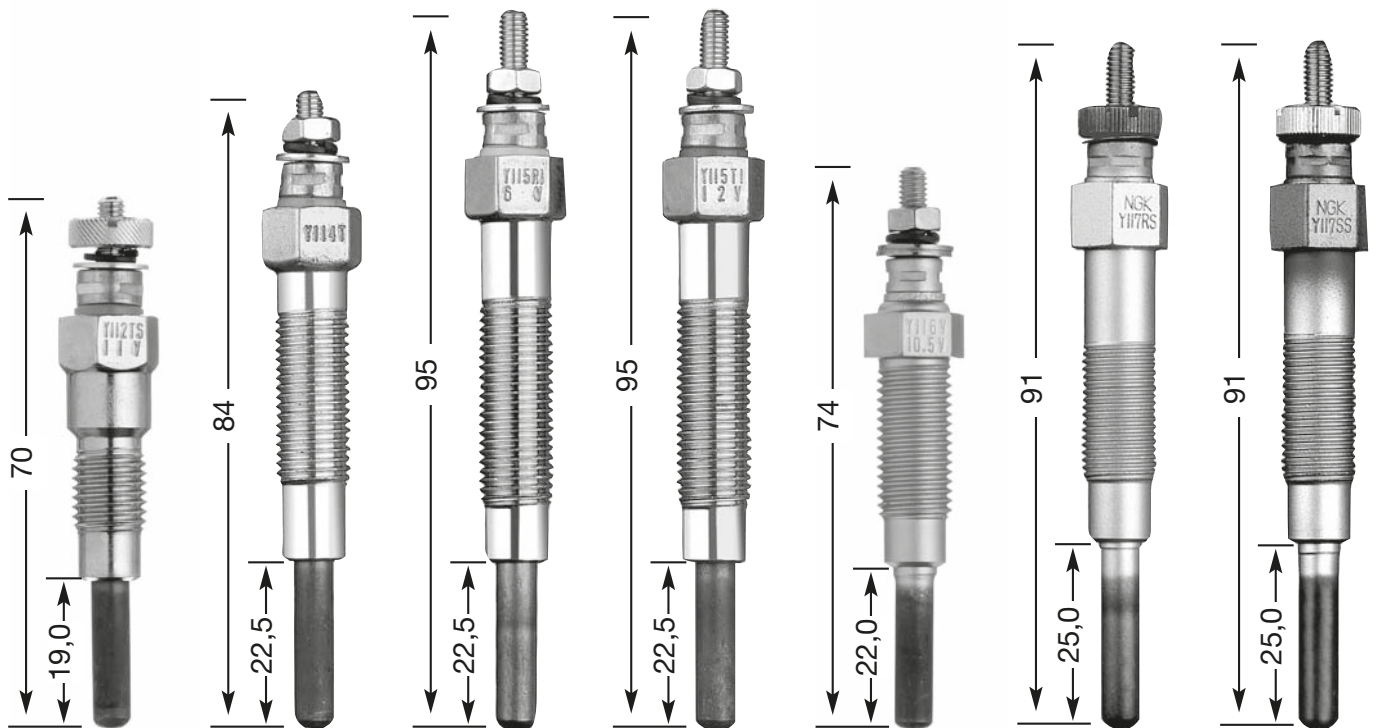

**Y-112 TS**  
M 10 x 1.25  
12 Hex  
11 V

**Y-114 T**  
M 10 x 1.25  
12 Hex  
10,5 V

**Y-115 R1**  
M 10 x 1.25  
12 Hex  
6 V

**Y-115 T1**  
M 10 x 1.25  
12 Hex  
12 V

**Y-116 V**  
M 10 x 1.25  
12 Hex  
10,5 V

**Y-117 RS**  
M 10 x 1  
12 Hex  
6,5 V

**Y-117 SS**  
M 10 x 1  
12 Hex  
8,5 V

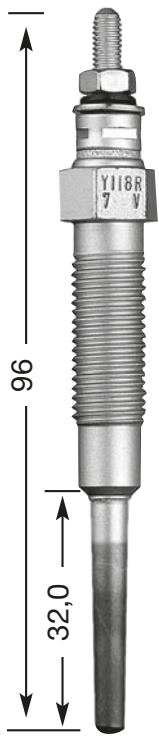

**Y-118 R**  
M 10 x 1.25  
12 Hex  
7 V

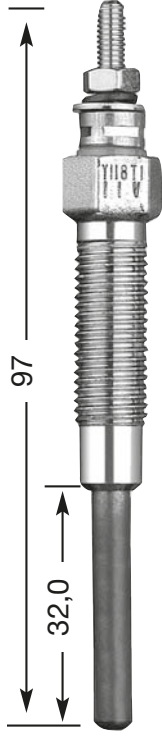

**Y-118 T1**  
M 10 x 1.25  
12 Hex  
11 V

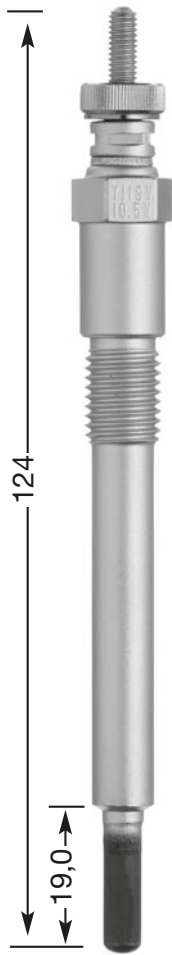

**Y-119 V**  
M 10 x 1.25  
12 Hex  
10,5 V

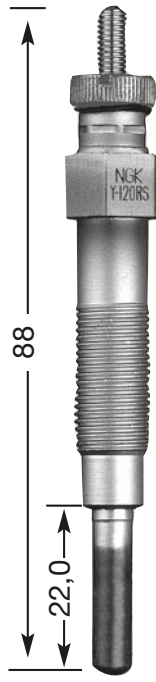

**Y-120 RS**  
M 10 x 1.0  
12 Hex  
6,5 V

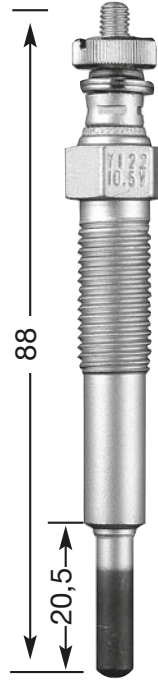

**Y-122**  
M 10 x 1.25  
12 Hex  
10,5 V

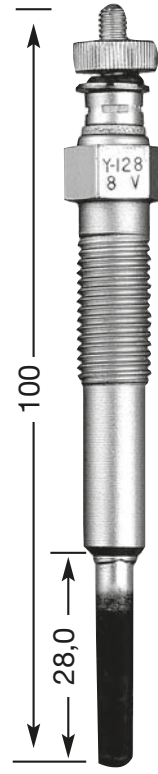

**Y-128**  
M 10 x 1.25  
12 Hex  
8 V

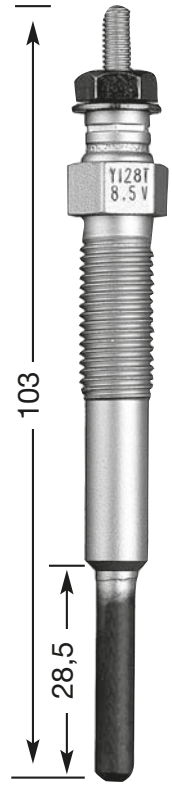

**Y-128 T**  
M 10 x 1.25  
12 Hex  
8,5 V

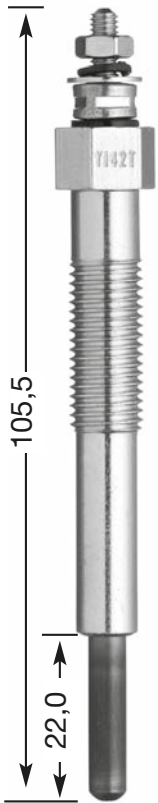

**Y-142 T**  
M 10 x 1.25  
12 Hex

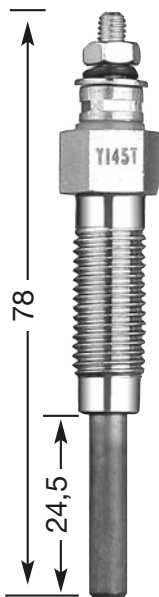

**Y-145 T**  
M 10 x 1.25  
12 Hex  
10,5 V

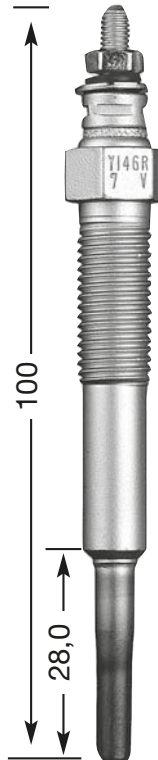

**Y-146 R**  
M 10 x 1.25  
12 Hex  
7 V

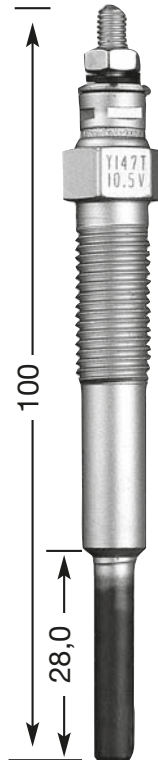

**Y-147 T**  
M 10 x 1.25  
12 Hex  
10,5 V

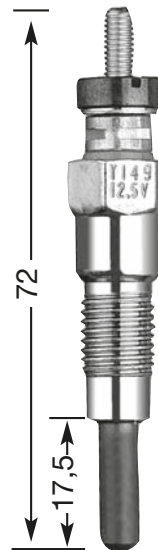

**Y-149**  
M 10 x 1.25  
12 Hex  
12,5 V

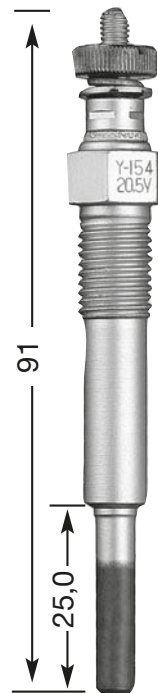

**Y-154**  
M 10 x 1.25  
12 Hex  
20,5 V

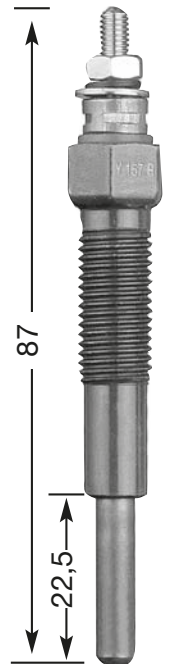

**Y-157 R**  
M 10 x 1.25  
12 Hex  
23 V

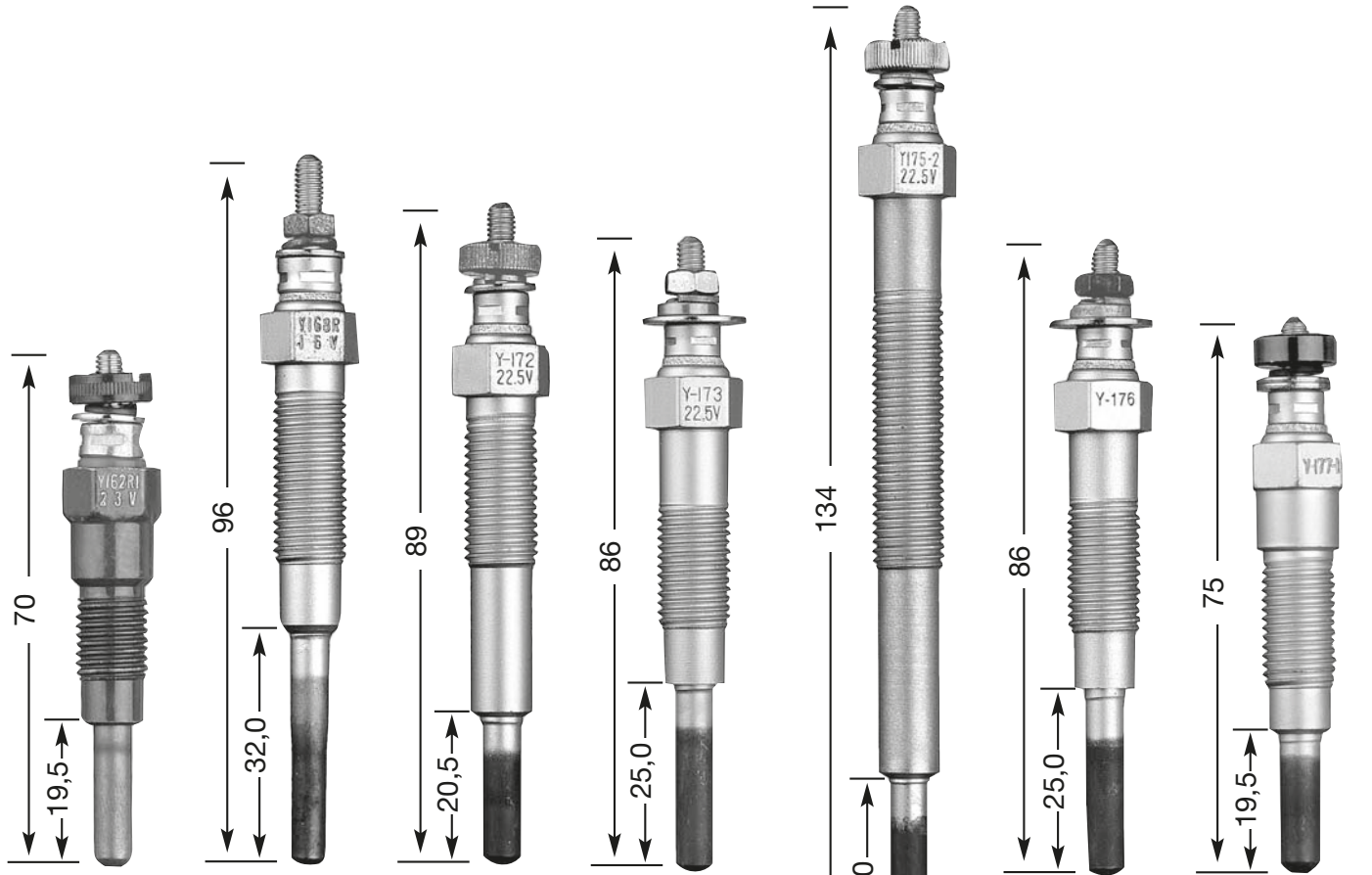

**Y-162 R1**  
M 10 x 1.25  
12 Hex  
23 V

**Y-168 R**  
M 10 x 1.25  
12 Hex  
16 V

**Y-172**  
M 10 x 1.25  
12 Hex  
22,5

**Y-173**  
M 10 x 1.25  
12 Hex  
22,5 V

**Y-175-2**  
M 10 x 1.25  
12 Hex  
22,5 V

**Y-176**  
M 10 x 1.25  
12 Hex  
19 V

**Y-177-1**  
M 10 x 1.25  
12 Hex  
21 V

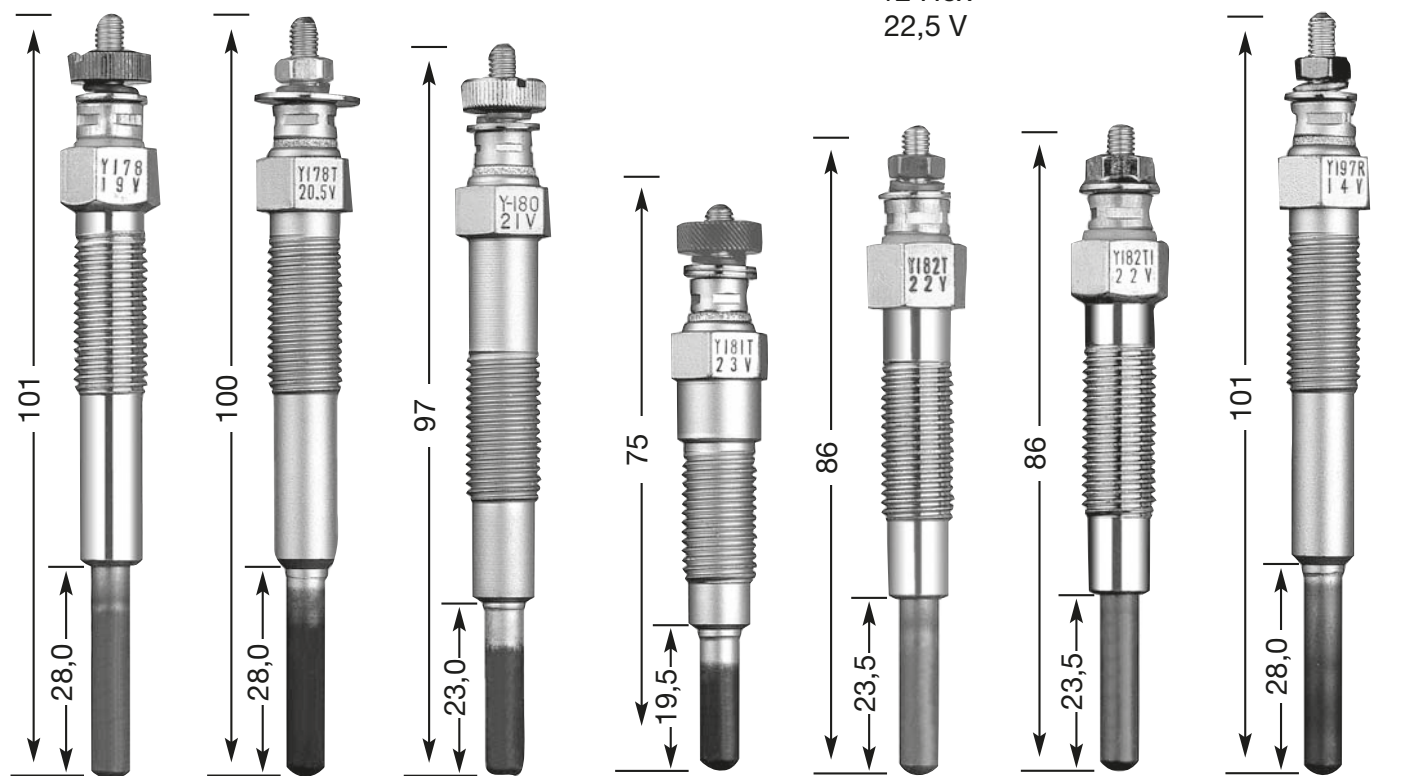

**Y-178**  
M 10 x 1.25  
12 Hex  
19 V

**Y-178 T**  
M 10 x 1.25  
12 Hex  
20,5 V

**Y-180**  
M 10 x 1.25  
12 Hex  
21 V

**Y-181 T**  
M 10 x 1.25  
12 Hex  
23 V

**Y-182 T**  
M 10 x 1.25  
12 Hex  
22 V

**Y-182 T1**  
M 10 x 1.25  
12 Hex  
22 V

**Y-197 R**  
M 10 x 1.25  
12 Hex  
14 V



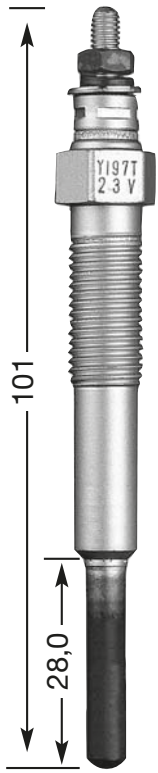

**Y-197 T**  
M 10 x 1.25  
12 Hex  
23 V

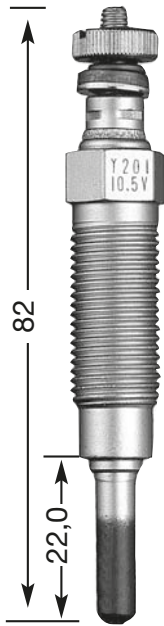

**Y-201**  
M 12 x 1.25  
12 Hex  
10,5 V

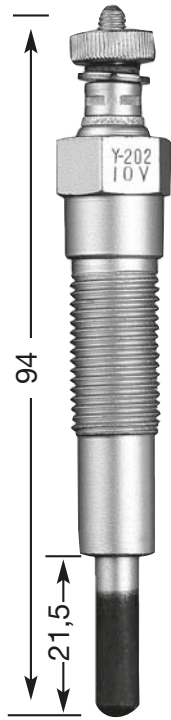

**Y-202**  
M 12 x 1.25  
14 Hex  
10 V

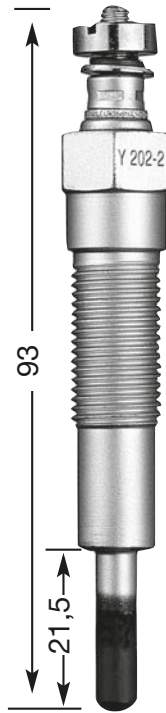

**Y-202-2**  
M 12 x 1.25  
14 Hex

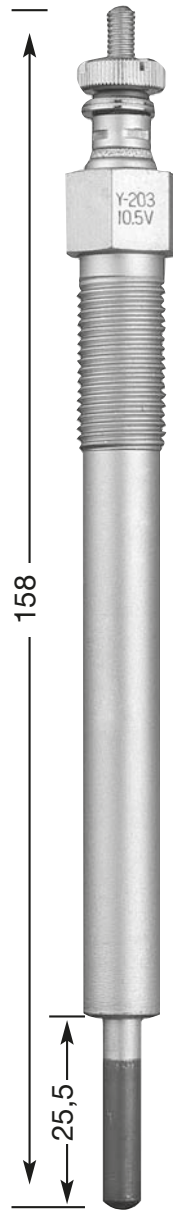

**Y-203**  
M 12 x 1.25  
14 Hex  
10,5 V

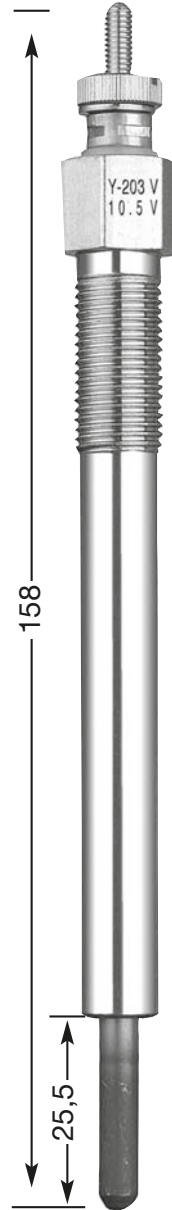

**Y-203 V**  
M 12 x 1.25  
14 Hex  
10,5 V

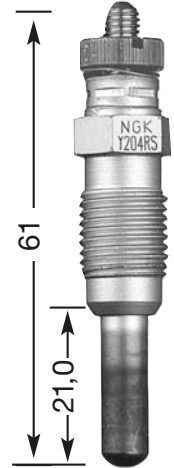

**Y-204 RS**  
M 12 x 1.25  
12 Hex  
6,5 V

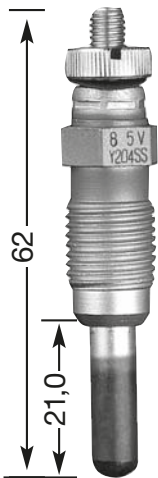

**Y-204 SS**  
M 12 x 1.25  
12 Hex  
8,5 V

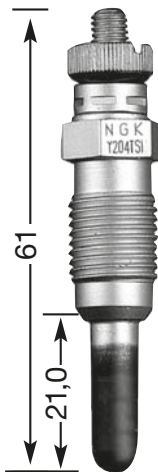

**Y-204 TS1**  
M 12 x 1.25  
12 Hex  
11 V

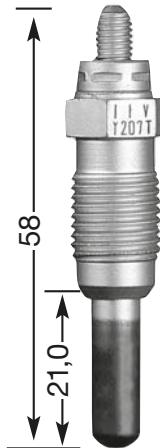

**Y-207 T**  
M 12 x 1.25  
12 Hex  
11 V

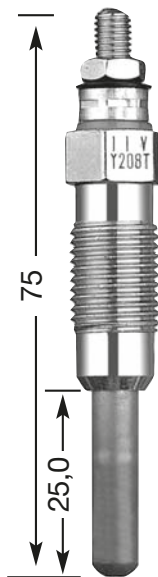

**Y-208 T**  
M 12 x 1.25  
12 Hex  
11 V

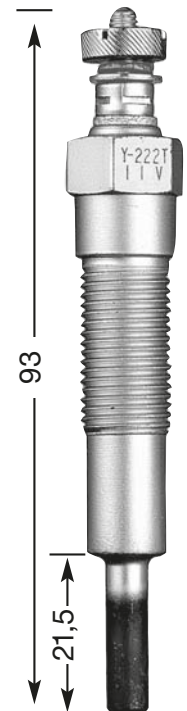

**Y-222 T**  
M 12 x 1.25  
14 Hex  
11 V



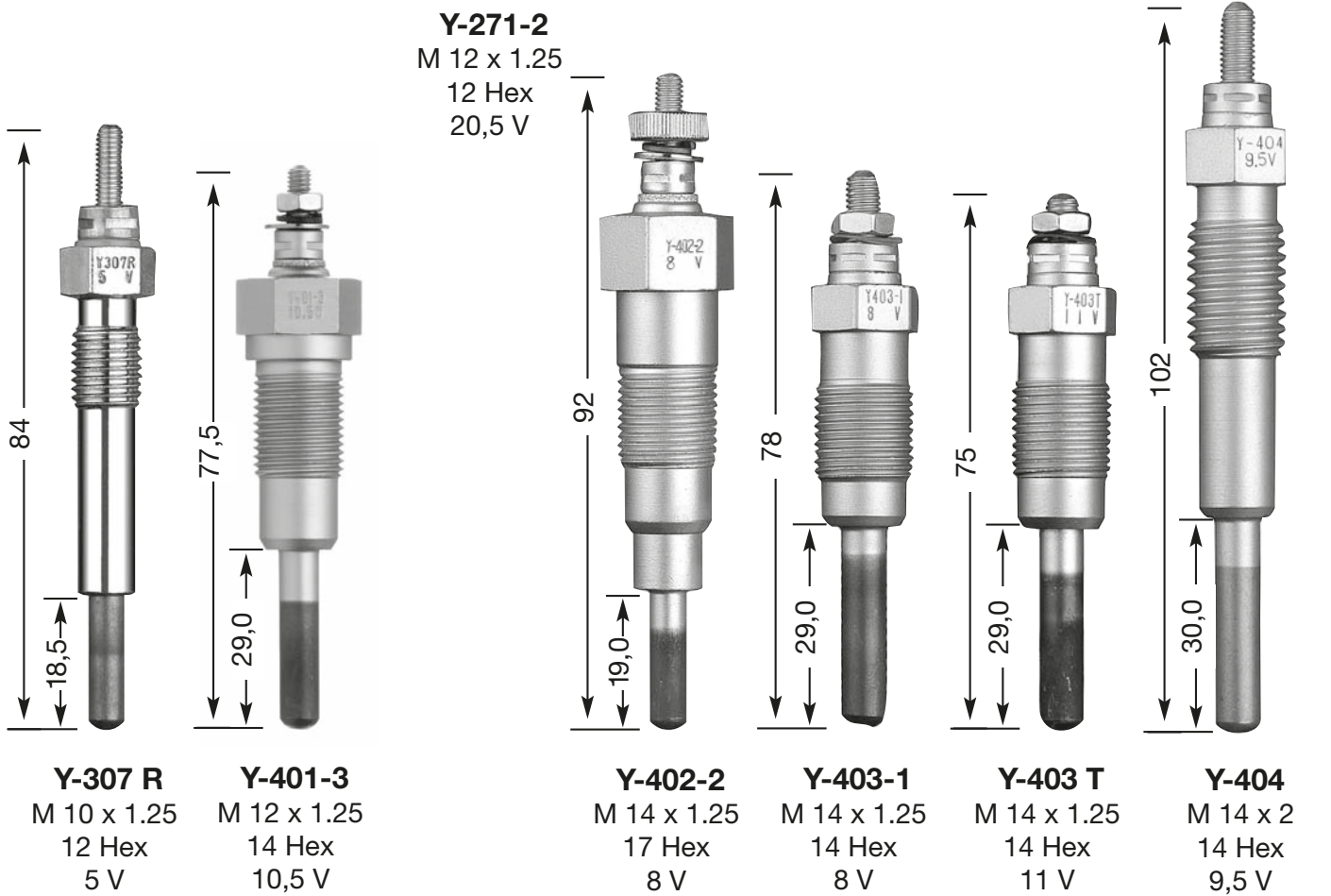
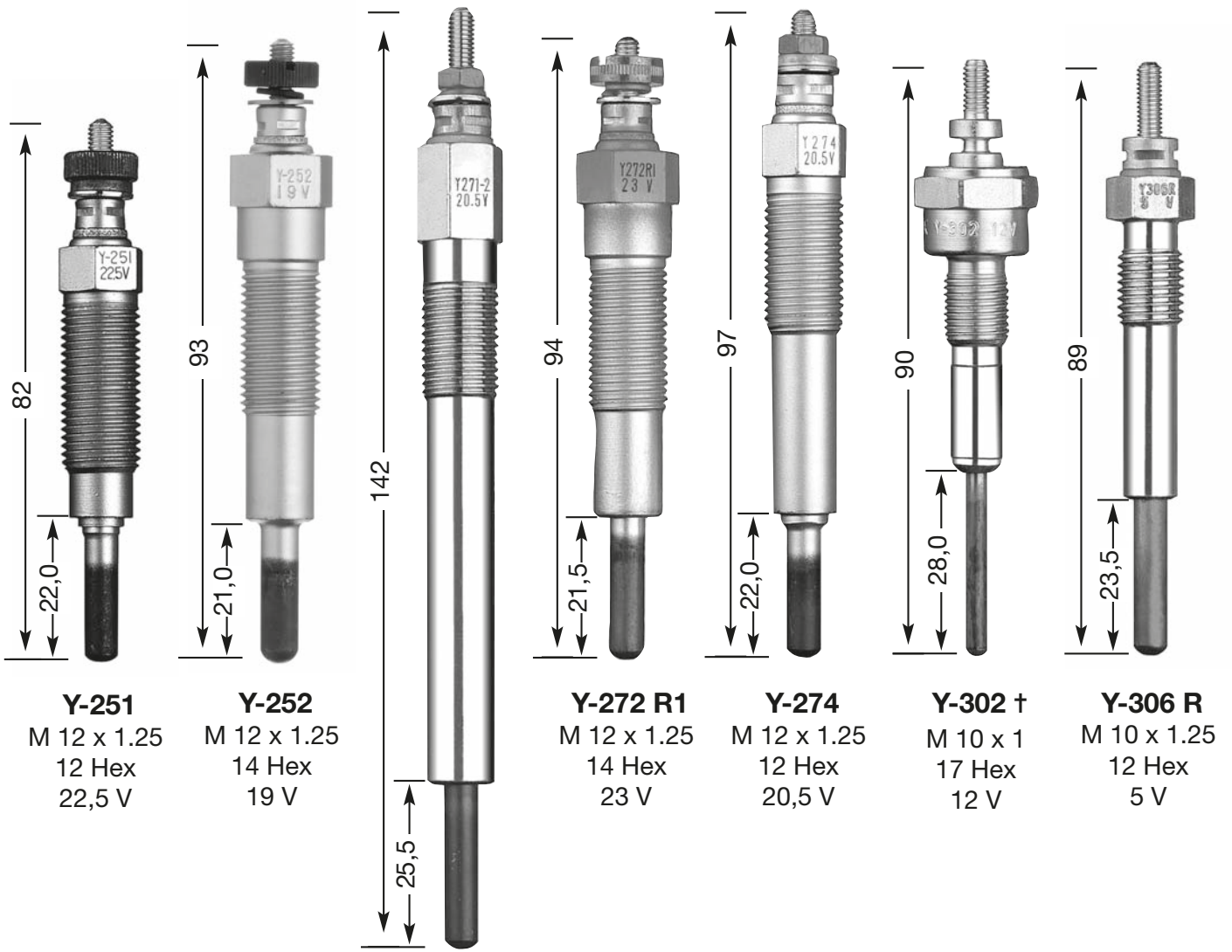

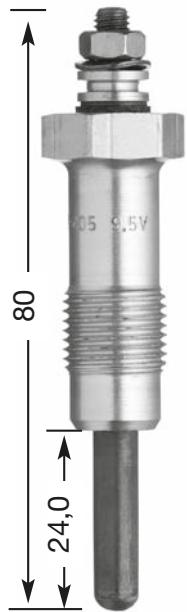

**Y-405**  
M 14 x 1.25  
17 Hex  
9,5 V

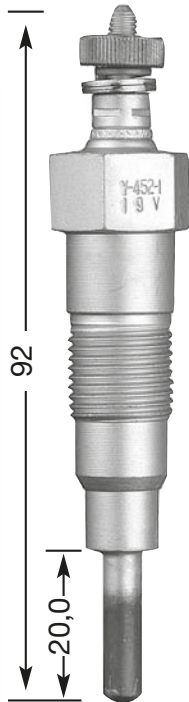

**Y-452-1**  
M 14 x 1.25  
17 Hex  
19 V

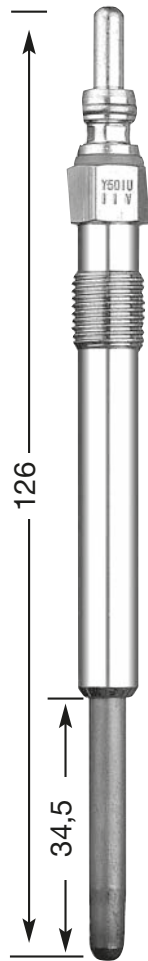

**Y-501-U**  
M 10 x 1.0  
10 Hex  
11 V  
**DP 31**

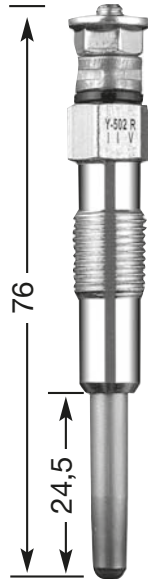

**Y-502 R**  
M 10 x 1.0  
10 Hex  
11 V

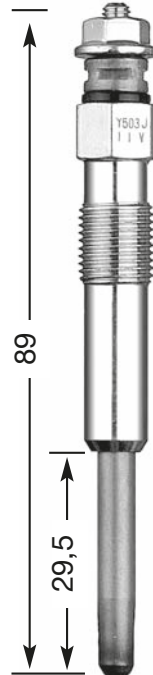

**Y-503 J**  
M 10 x 1.0  
10 Hex  
11 V

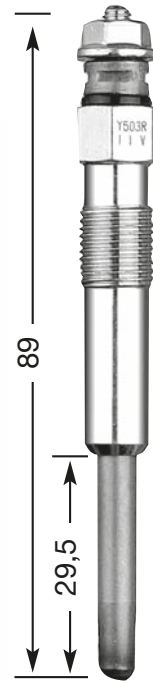

**Y-503 R**  
M 10 x 1.0  
10 Hex  
11 V

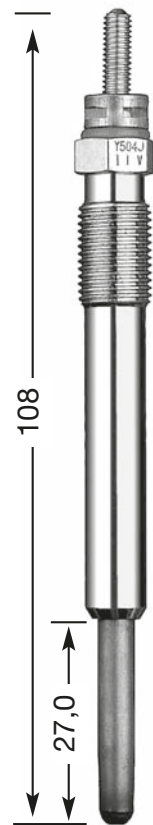

**Y-504 J**  
M 10 x 1.0  
10 Hex  
11 V  
**DP 24**

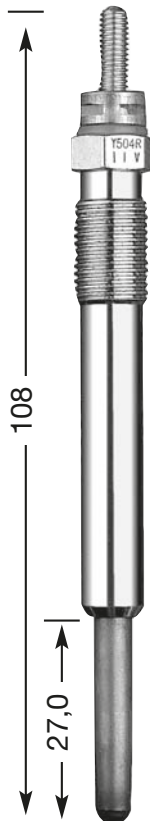

**Y-504 R**  
M 10 x 1.0  
10 Hex  
11 V

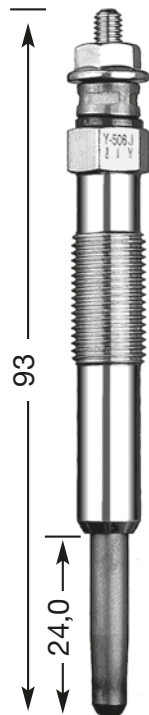

**Y-506 J**  
M 10 x 1.0  
10 Hex  
11 V  
**DP 7**

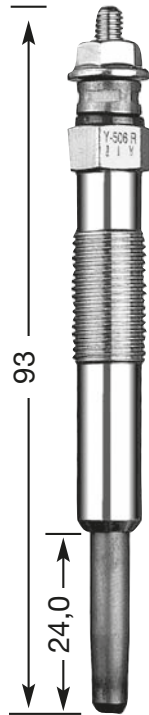

**Y-506 R**  
M 10 x 1.0  
10 Hex  
11 V



**Y-507 J**  
M 10 x 1.0  
10 Hex  
11 V  
**DP 32**

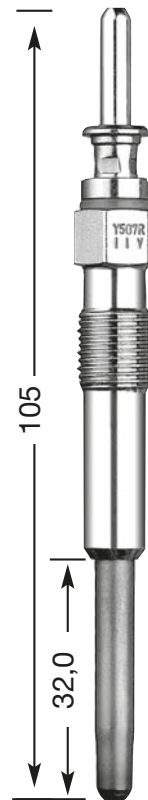

**Y-507 R**  
M 10 x 1.0  
10 Hex  
11 V

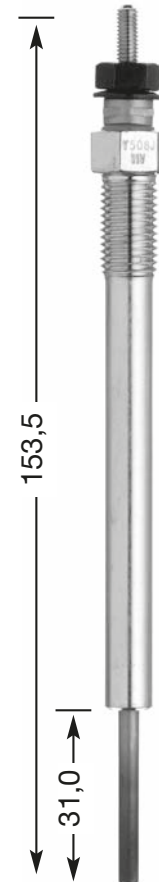

**Y-508 J**  
M 10 x 1.25  
12 Hex  
11 V

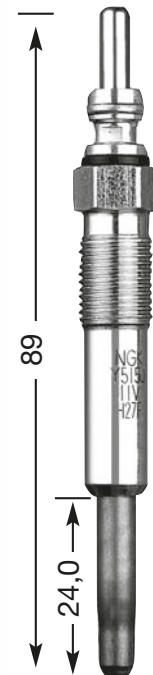

**Y-515 J**  
M 10 x 1.0  
10 Hex  
11 V  
**DP 18**



**Y-516 J**  
M 10 x 1.0  
10 Hex  
11 V  
**DP 12**

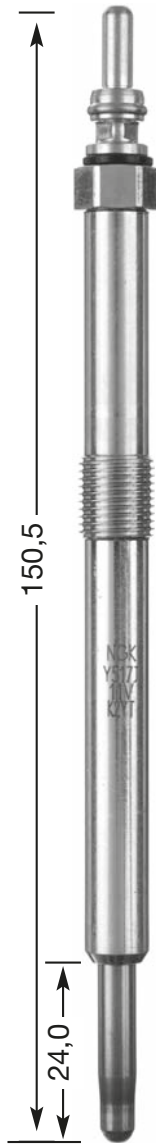

**Y-517 J**  
M 10 x 1.0  
10 Hex  
11 V  
**DP 66**

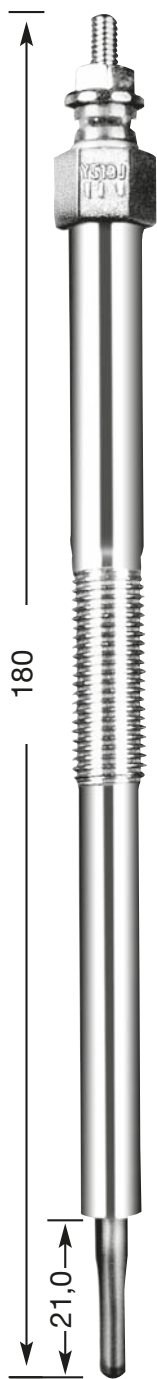

**Y-519 J**  
M 10 x 1.25  
10 Hex  
11 V  
**DP 61**

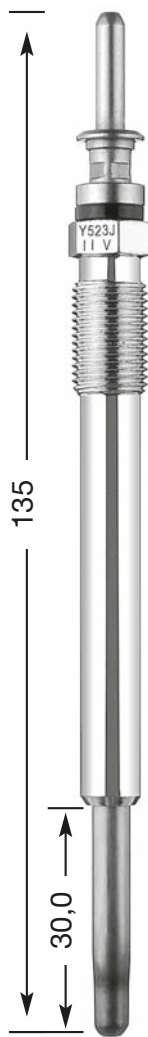

**Y-523 J**  
M 10 x 1.0  
10 Hex  
11 V  
**DP 37**

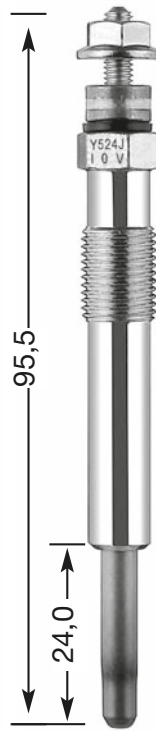

**Y-524 J**  
M 10 x 1.0  
10 Hex  
10 V  
**DP 27**

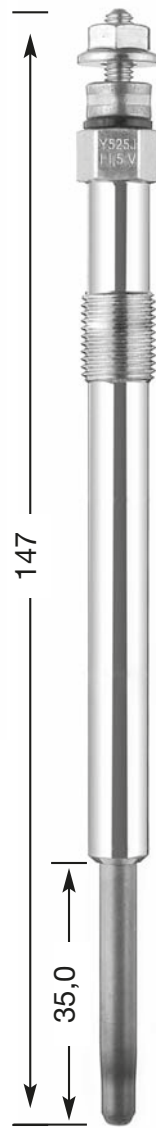

**Y-525 J**  
M 10 x 1,0  
10 Hex  
11,5 V  
**DP 35**

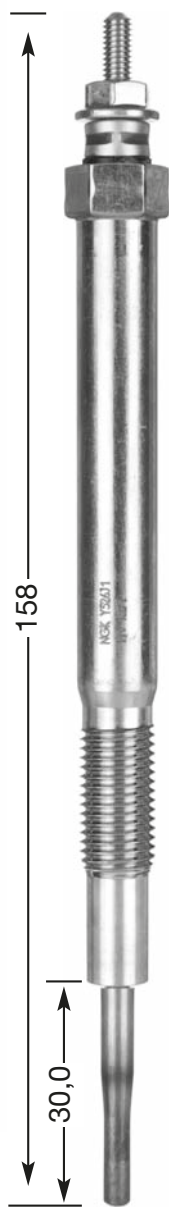

**Y-526 J1**  
M 10 x 1.25  
12 Hex  
11 V  
**DP 69**

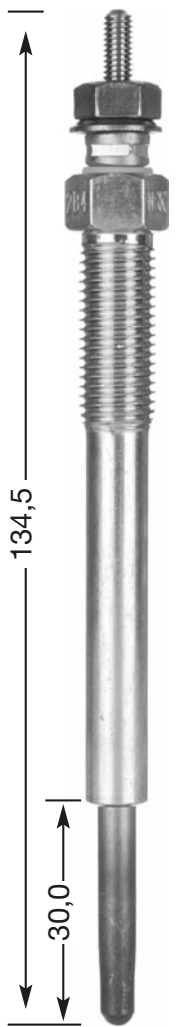

**Y-527 J**  
M 10 x 1.25  
12 Hex  
11 V  
**DP 67**

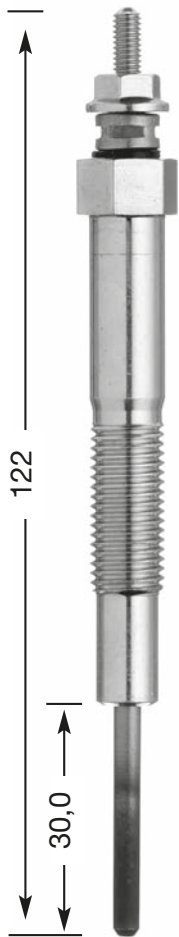

**Y-529 J**  
M 10 x 1.25  
12 Hex  
11 V

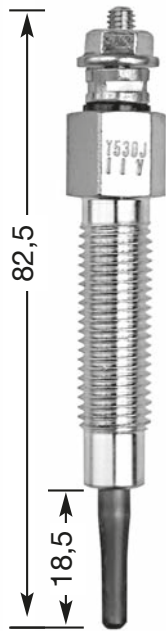

**Y-530 J**  
M 10 x 1.25  
12 Hex  
11 V

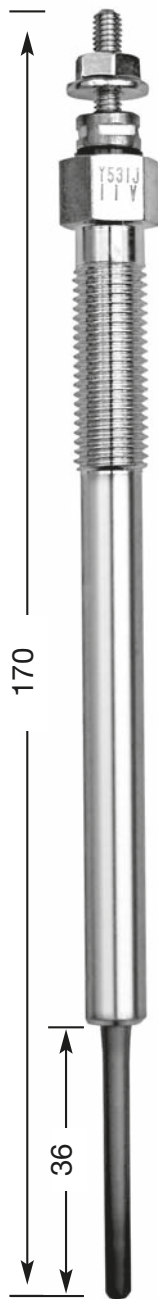

**Y-531 J**  
M 10 x 1.25  
12 Hex  
11 V  
**DP 44**

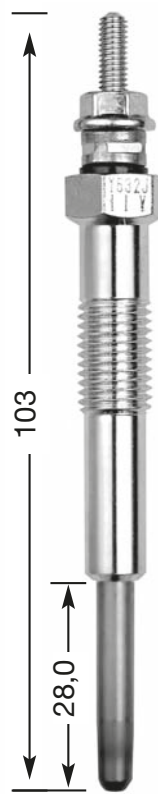

**Y-532 J**  
M 10 x 1.25  
12 Hex  
11 V

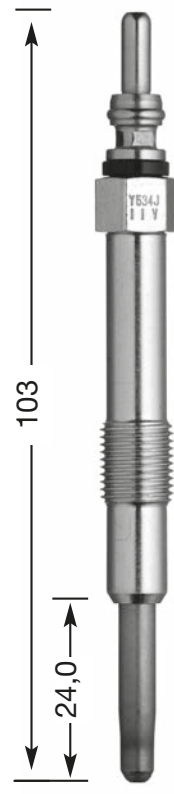

**Y-534 J**  
M 10 x 1.0  
10 Hex  
11 V  
**DP 36**



**Y-541 J**  
M 10 x 1.25  
12 Hex  
**DP 42**



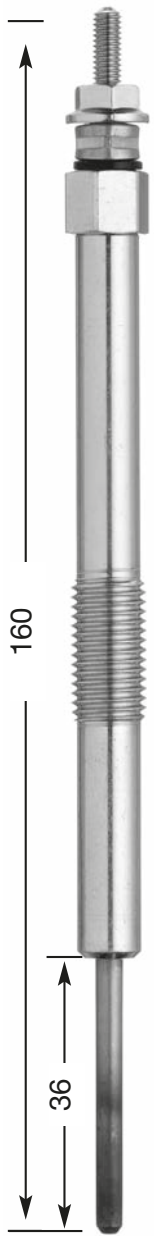

**Y-542 J**  
M 10 x 1.25  
10 Hex  
11 V  
DP 45

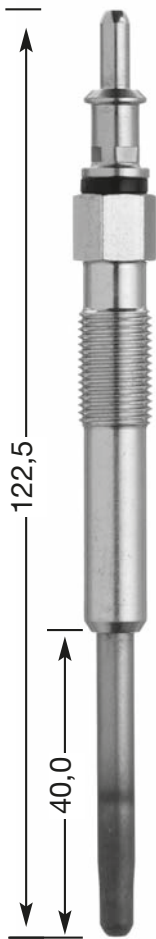

**Y-543 J**  
M 10 x 1.25  
10 Hex  
11 V  
DP 46

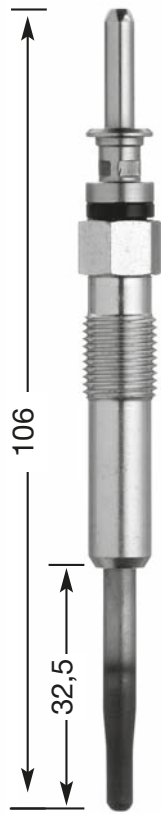

**Y-547 AS**  
M 10 x 1.0  
10 Hex  
5 V  
DP 47



**Y-548 J**  
M 10 x 1.0  
10 Hex  
11,5 V  
DP 75

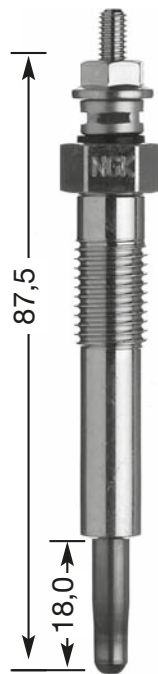

**Y-603 J**  
M 12 x 1.25  
12 Hex  
11 V  
DP 60

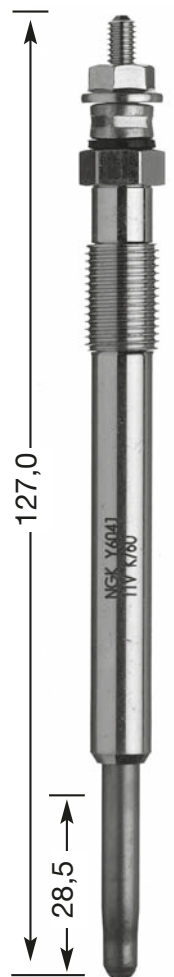

**Y-604 J**  
M 10 x 1.0  
10 Hex  
11 V

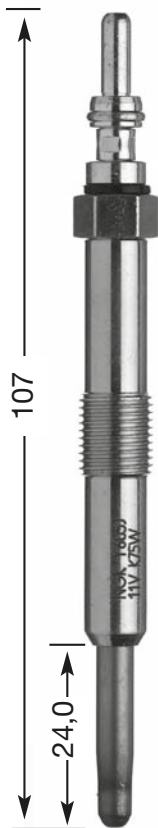

**Y-605 J**  
M 10 x 1.0  
10 Hex  
11 V

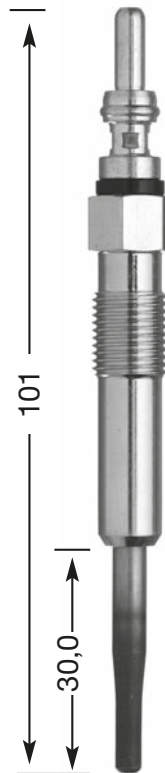

**Y-607 AS**  
M 10 x 1.0  
10 Hex  
5 V  
DP 50

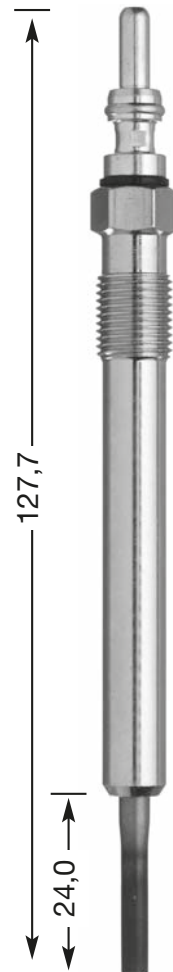

**Y-609 AS**  
M 10 x 1.0  
10 Hex  
4,4 V  
DP 49

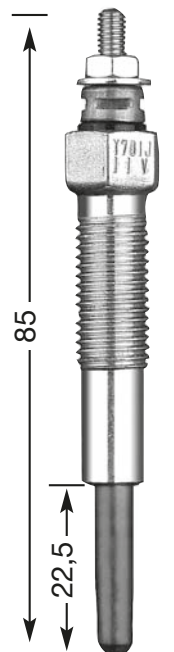

**Y-701 J**  
M 10 x 1.25  
12 Hex  
11 V  
DP 39

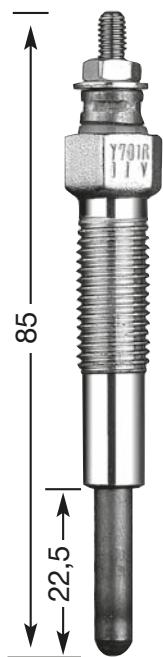

**Y-701 R**  
M 10 x 1.25  
12 Hex  
11 V

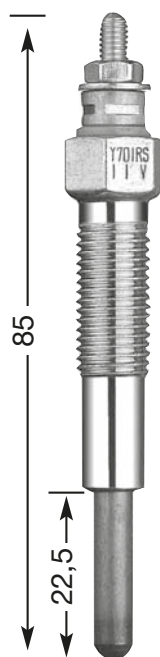

**Y-701 RS**  
M 10 x 1.25  
12 Hex  
11 V

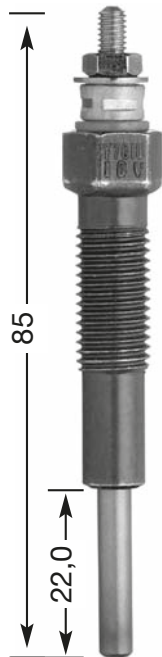

**Y-701 U**  
M 10 x 1.25  
12 Hex  
10 V

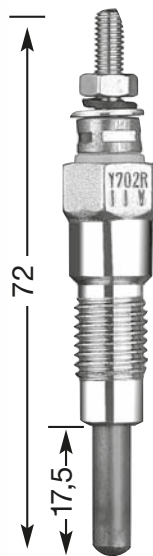

**Y-702 R**  
M 10 x 1.25  
12 Hex  
11 V

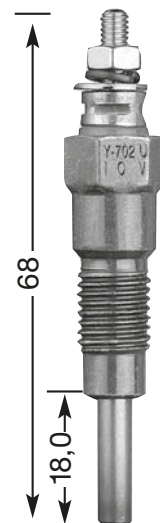

**Y-702 U**  
M 10 x 1.25  
12 Hex  
10 V

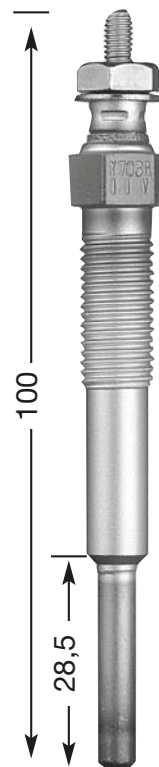

**Y-703 R**  
M 10 x 1.25  
12 Hex  
11 V

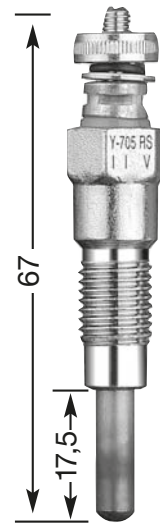

**Y-705 RS**  
M 10 x 1.25  
12 Hex  
11 V

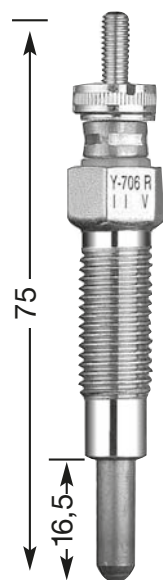

**Y-706 R**  
M 10 x 1.25  
12 Hex  
11 V

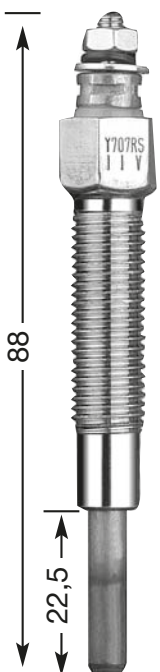

**Y-707 RS**  
M 10 x 1.25  
12 Hex  
11 V

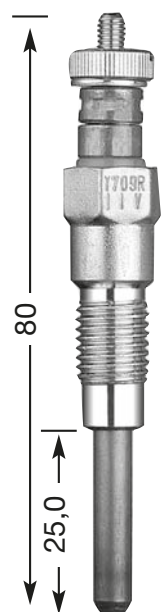

**Y-709 R**  
M 10 x 1.25  
12 Hex  
11 V

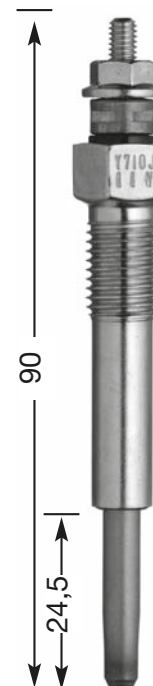

**Y-710 J**  
M 10 x 1.25  
12 Hex  
11 V

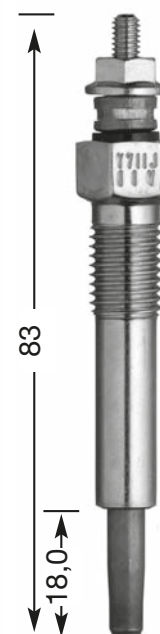

**Y-711 J**  
M 10 x 1.25  
12 Hex  
11 V

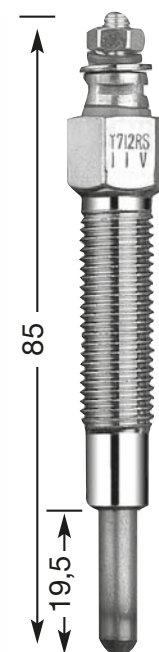

**Y-712 RS**  
M 10 x 1.25  
12 Hex  
11 V

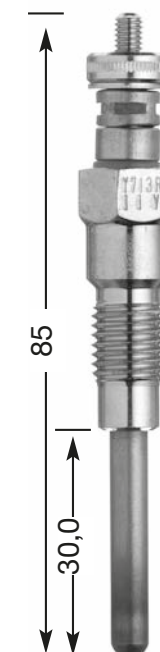

**Y-713 R**  
M 10 x 1.25  
12 Hex  
11 V

**DP 28**

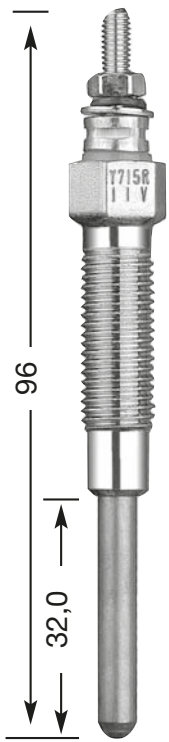

**Y-715 R**  
M 10 x 1.25  
12 Hex  
11 V

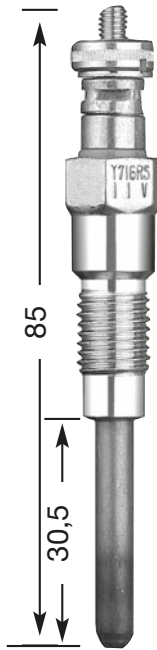

**Y-716 RS**  
M 10 x 1.25  
12 Hex  
11 V

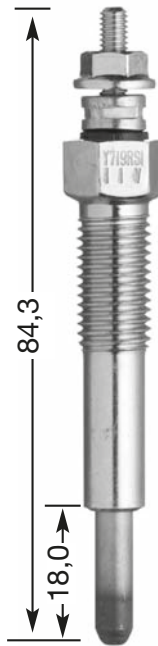

**Y-719 RS 1**  
M 10 x 1.25  
12 Hex  
11 V

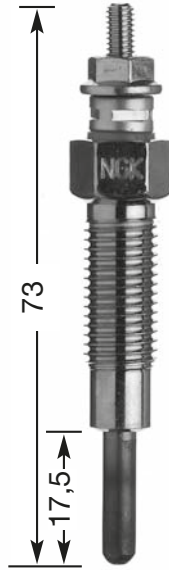

**Y-720 U1**  
M 12 x 1.25  
12 Hex  
10 V

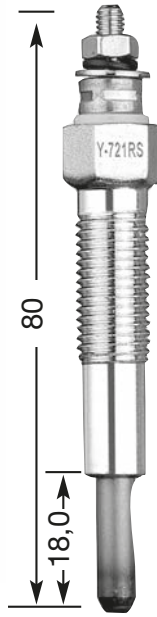

**Y-721 RS**  
M 10 x 1.25  
12 Hex  
11 V

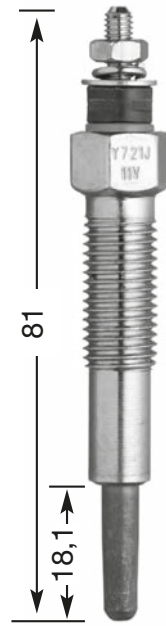

**Y-721 J**  
M 10 x 1.25  
12 Hex  
11 V

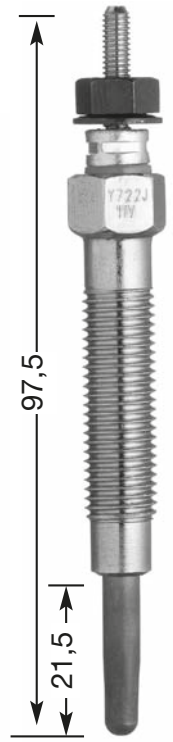

**Y-722 J**  
M 10 x 1.25  
12 Hex  
11 V

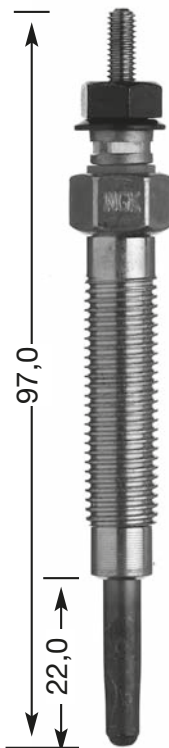

**Y-722 JS**  
M 12 x 1.25  
12 Hex  
11 V

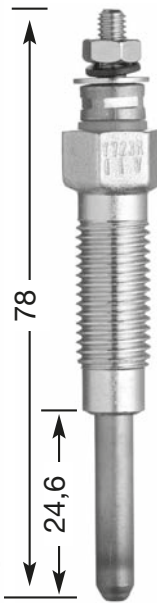

**Y-723 R**  
M 10 x 1.25  
12 Hex  
11 V

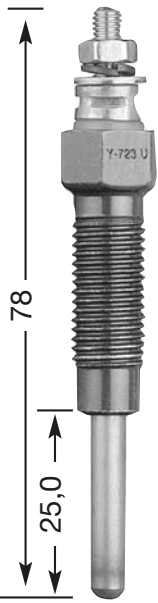

**Y-723 U**  
M 10 x 1.25  
12 Hex  
8 V

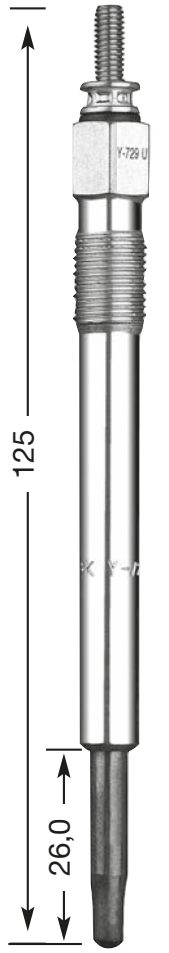

**Y-729 U**  
M 10 x 1.0  
10 Hex  
11,5 V  
**DP 34**

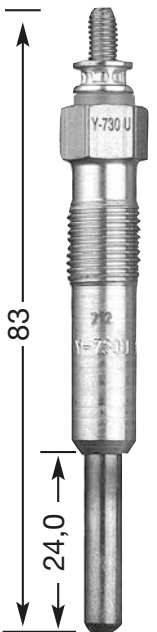

**Y-730 U**  
M 10 x 1.0  
10 Hex  
11 V  
**DP 17**

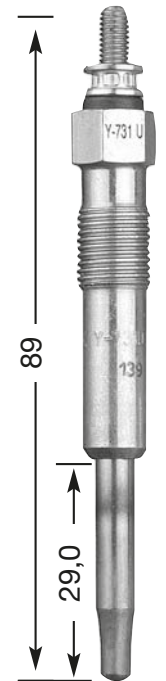

**Y-731 U**  
M 10 x 1.0  
10 Hex  
11 V  
**DP 9**

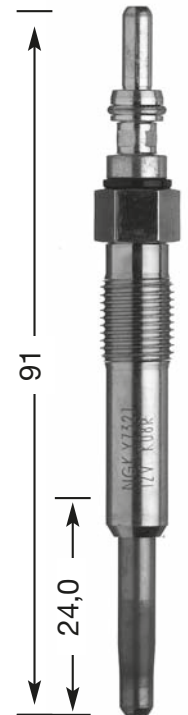

**Y-732 J**  
M 10 x 1.0  
10 Hex  
12 V  
**DP 4**

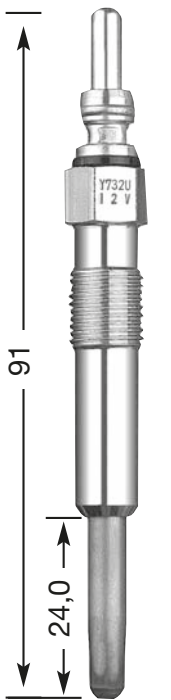

**Y-732 U**  
M 10 x 1.0  
10 Hex  
12 V  
**DP 4**

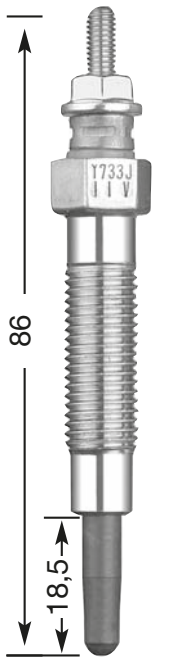

**Y-733 J**  
M 10 x 1.25  
12 Hex  
11 V  
**DP 13**

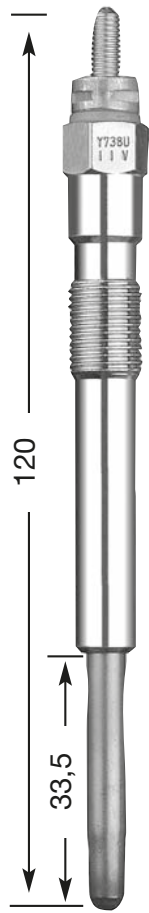

**Y-738 U**  
M 10 x 1.0  
10 Hex  
11 V

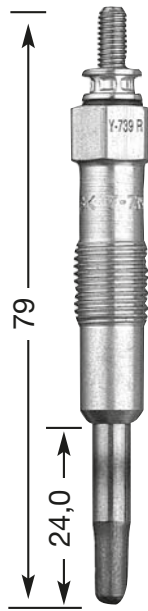

**Y-739 R**  
M 10 x 1.0  
10 Hex  
11 V

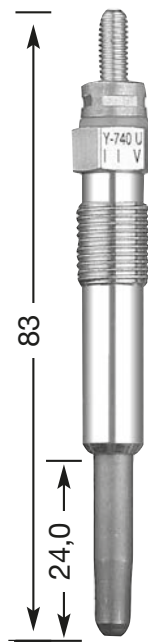

**Y-740 U**  
M 10 x 1.0  
10 Hex  
11 V  
**DP 22**

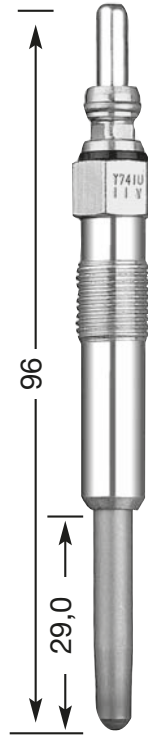

**Y-741 U**  
M 10 x 1  
10 Hex  
11 V  
**DP 20**

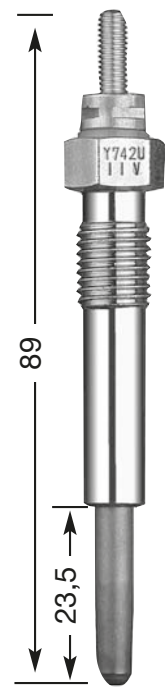

**Y-742 U**  
M 10 x 1.25  
12 Hex  
11 V

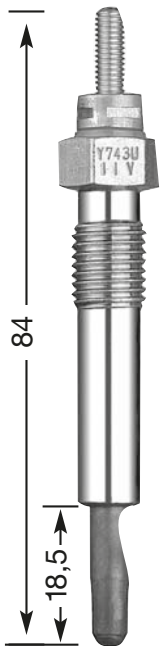

**Y-743 U**  
M 10 x 1.25  
12 Hex  
11 V

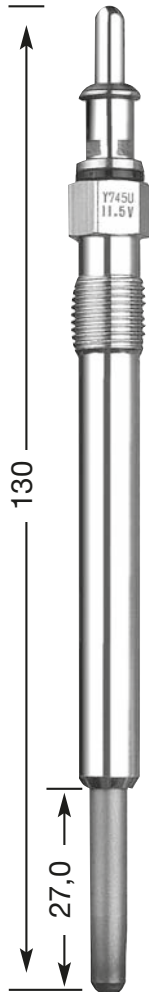

**Y-745 U**  
M 10 x 1.0  
10 Hex  
11,5 V  
**DP 11**

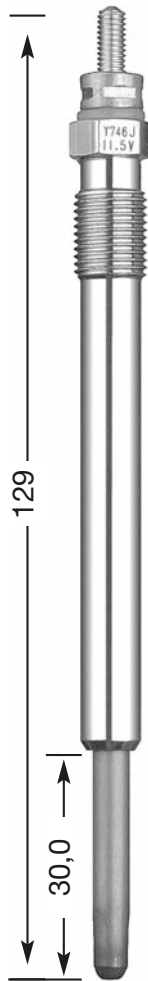

**Y-746 J**  
M 10 x 1.0  
10 Hex  
11,5 V  
**DP 38**

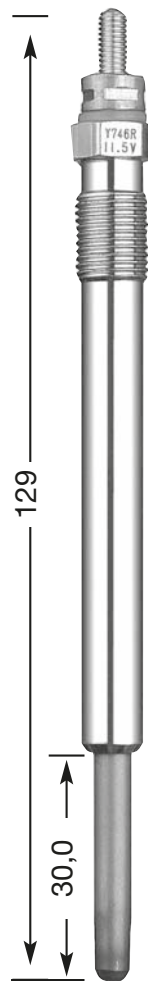

**Y-746 R**  
M 10 x 1.0  
10 Hex  
11,5 V



**Y-747 U**  
M 10 x 1  
10 Hex  
11 V  
**DP 26**

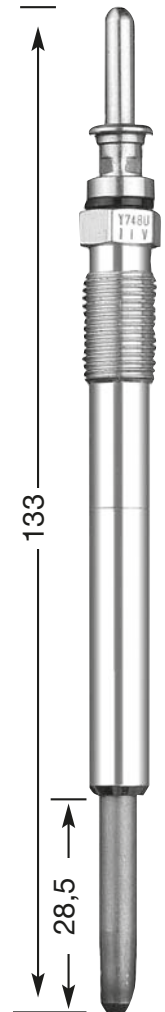

**Y-748 U**  
M 10 x 1  
10 Hex  
11 V  
**DP 14**



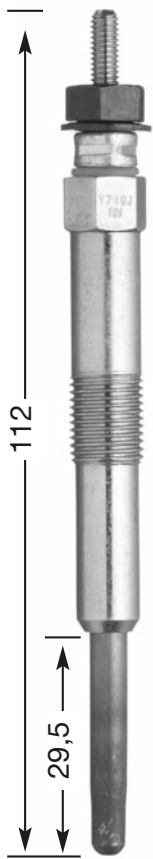

**Y-749 J**  
M 10 x 1.0  
10 Hex  
11 V



**Y-752 M**  
M 12 x 1.25  
12 Hex  
23 V

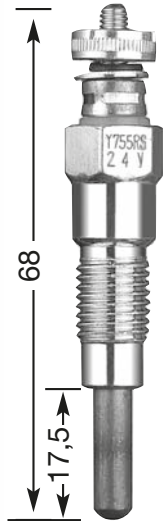

**Y-755 RS**  
M 10 x 1.25  
12 Hex  
24 V

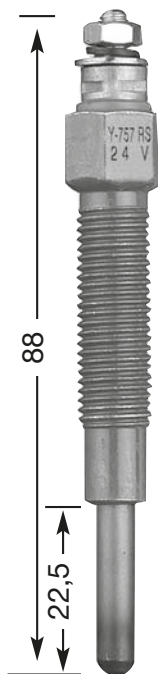

**Y-757 RS**  
M 10 x 1.25  
12 Hex  
24 V

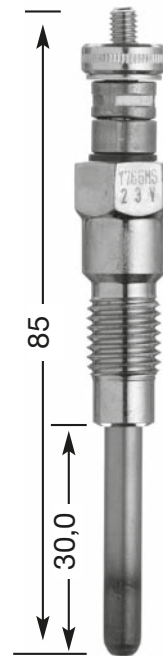

**Y-766 MS**  
M 10 x 1.25  
12 Hex  
23 V

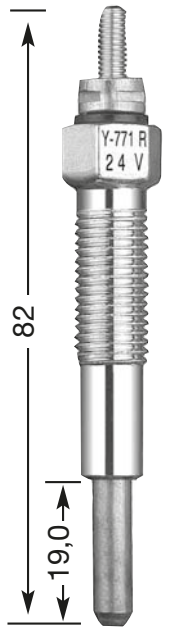

**Y-771 R**  
M 10 x 1.25  
12 Hex  
24 V

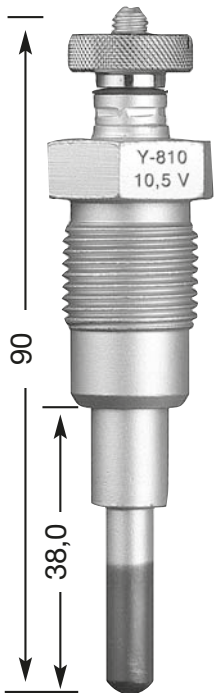

**Y-810**  
M 18 x 1.5  
20.6 Hex  
10,5 V

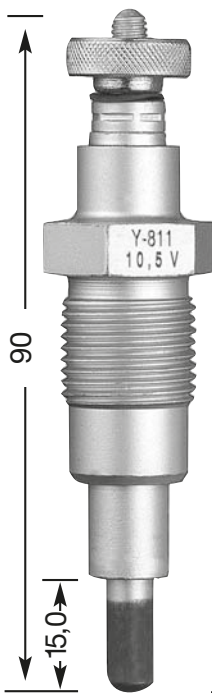

**Y-811**  
M 18 x 1.5  
20.6 Hex  
10,5 V

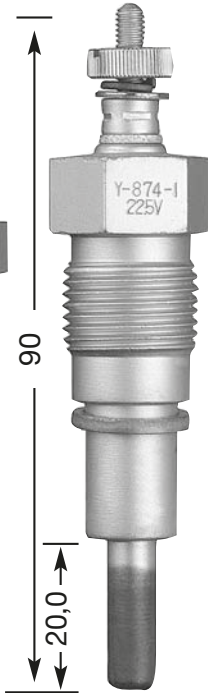

**Y-874-1**  
M 18 x 1.5  
19 Hex  
22,5 V

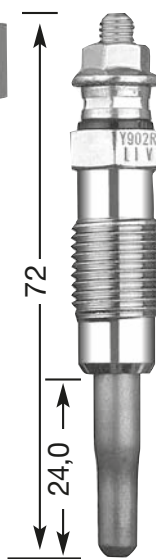

**Y-902 R**  
M 12 x 1.25  
12 Hex  
11 V

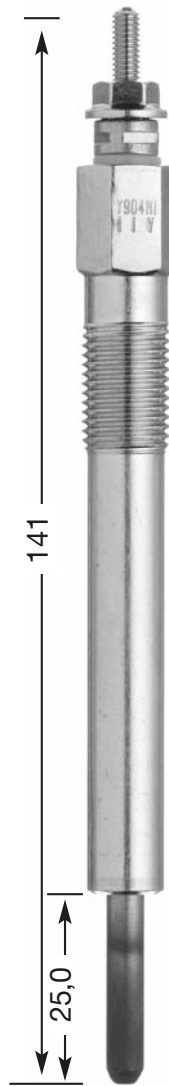

**Y-904 M1**  
M 12 x 1.25  
12 Hex  
11 V

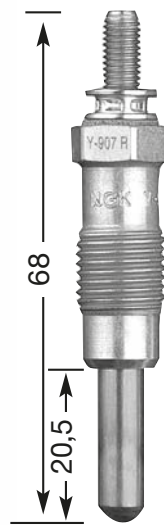

**Y-907 R**  
M 12 x 1.25  
12 Hex  
11,5 V

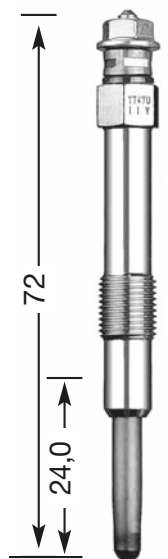

**Y-908 R**  
M 12 x 1.25  
12 Hex  
11 V

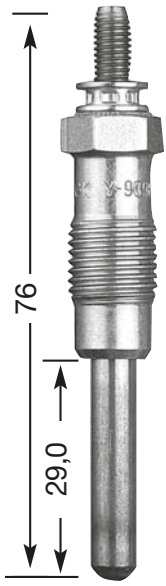

**Y-909 R**  
M 12 x 1.25  
12 Hex  
11 V

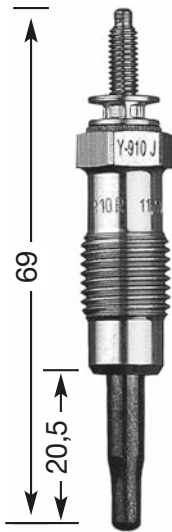

**Y-910 J**  
M 12 x 1.25  
12 Hex  
11,5 V  
**DP 3**

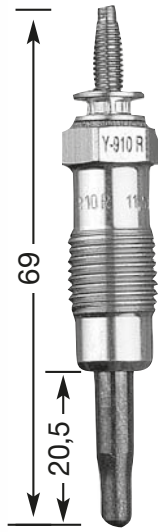

**Y-910 R**  
M 12 x 1.25  
12 Hex  
11,5 V

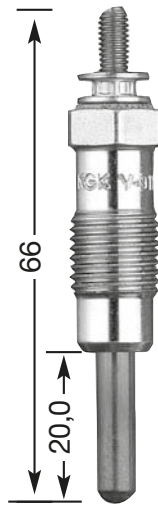

**Y-911 J**  
M 12 x 1.25  
12 Hex  
11 V  
**DP 33**

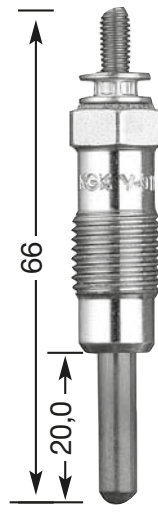

**Y-911 R**  
M 12 x 1.25  
12 Hex  
11 V

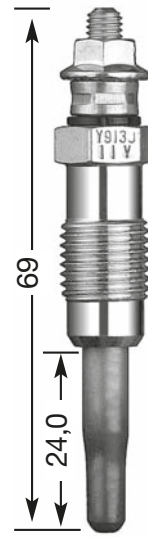

**Y-913 J**  
M 12 x 1.25  
12 Hex  
11 V  
**DP 15**

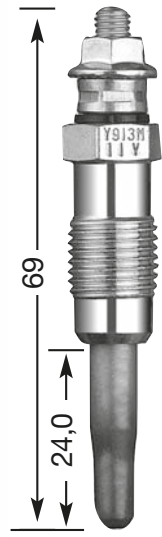

**Y-913 M**  
M 12 x 1.25  
12 Hex  
11 V

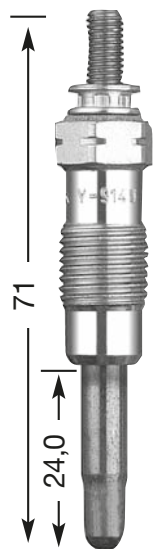

**Y-914 U**  
M 12 x 1.25  
12 Hex  
11 V

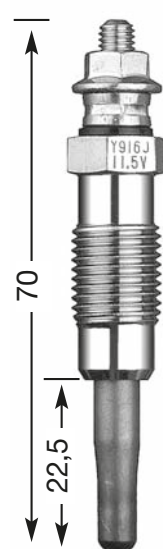

**Y-916 J**  
M 12 x 1.25  
12 Hex  
11,5 V  
**DP 6**

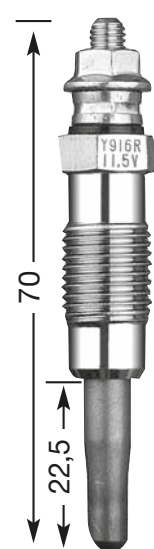

**Y-916 R**  
M 12 x 1.25  
12 Hex  
11,5 V

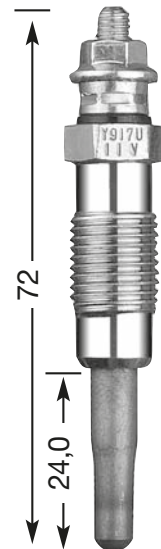

**Y-917 U**  
M 12 x 1.25  
12 Hex  
11 V

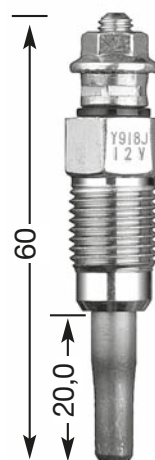

**Y-918 J**  
M 12 x 1.25  
12 Hex  
12 V  
**DP 2**

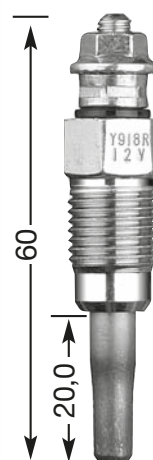

**Y-918 R**  
M 12 x 1.25  
12 Hex  
12 V

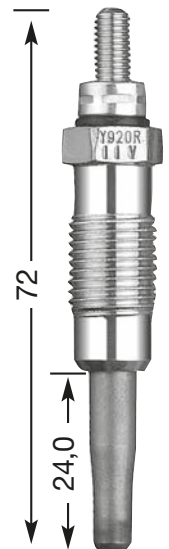

**Y-920 R**  
M 12 x 1.25  
12 Hex  
11 V

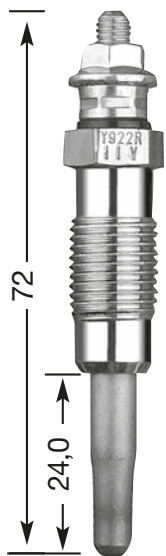

**Y-922 R**  
M 12 x 1.25  
12 Hex  
11 V

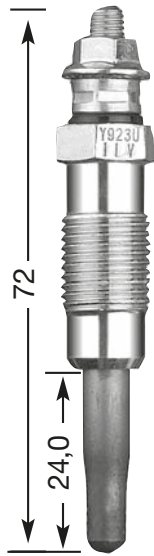

**Y-923 U**  
M 12 x 1.25  
12 Hex  
11 V

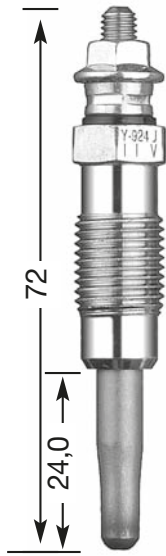

**Y-924 J**  
M 12 x 1.25  
12 Hex  
11 V

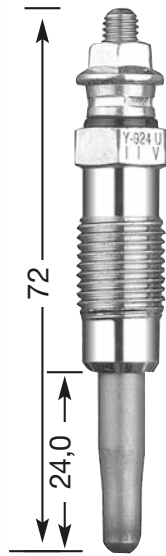

**Y-924 U**  
M 12 x 1.25  
12 Hex  
11 V

**DP 1**

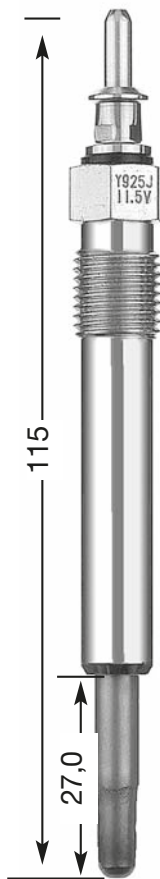

**Y-925 J**  
M 12 x 1.25  
12 Hex  
11,5 V  
**DP 16**

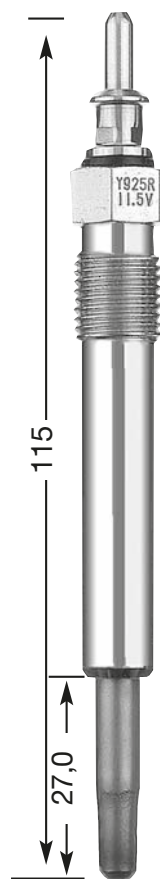

**Y-925 R**  
M 12 x 1.25  
12 Hex  
11,5 V

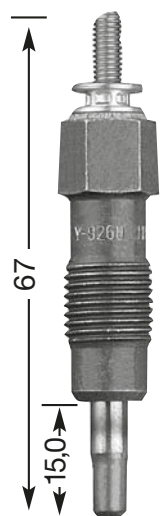

**Y-926 U**  
M 12 x 1.25  
12 Hex  
11 V

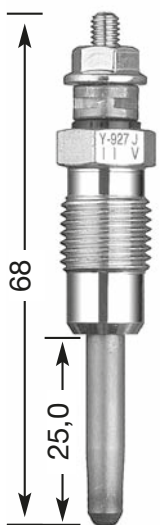

**Y-927 J**  
M 12 x 1.25  
12 Hex  
11 V  
**DP 19**

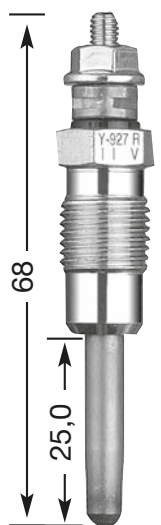

**Y-927 R**  
M 12 x 1.25  
12 Hex  
11 V

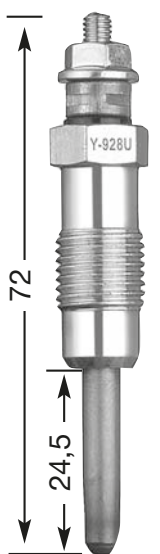

**Y-928 U**  
M 12 x 1.25  
12 Hex  
11 V  
**DP 29**

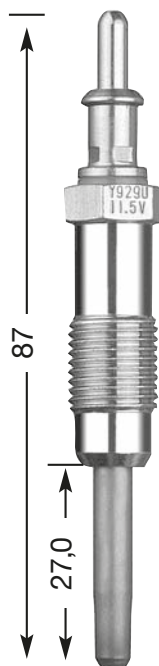

**Y-929 U**  
M 12 x 1.25  
12 Hex  
11,5 V  
**DP 41**

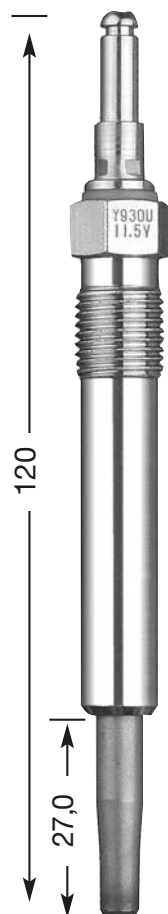

**Y-930 U**  
M 12 x 1.25  
12 Hex  
11,5 V  
**DP 30**

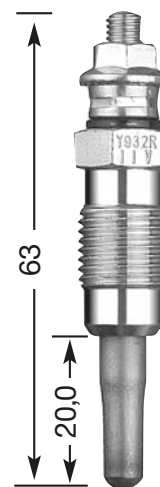

**Y-932 R**  
M 12 x 1.25  
12 Hex  
11 V

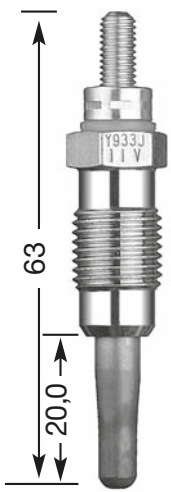

**Y-933 J**  
M 12 x 1.25  
12 Hex  
11 V  
**DP 25**

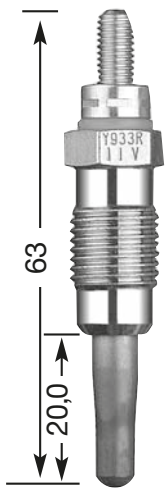

**Y-933 R**  
M 12 x 1.25  
12 Hex  
11 V

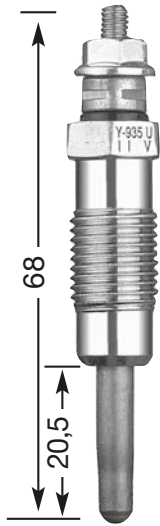

**Y-935 U**  
M 12 x 1.25  
12 Hex  
11 V  
**DP 23**

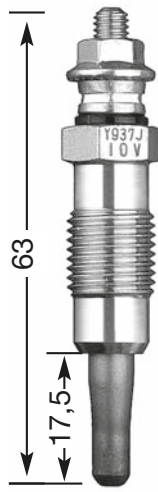

**Y-937 J**  
M 12 x 1.25  
12 Hex  
10 V  
**DP 5**

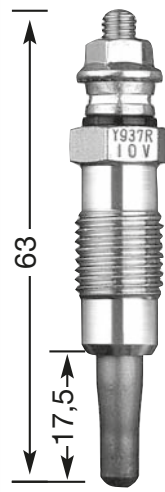

**Y-937 R**  
M 12 x 1.25  
12 Hex  
10 V

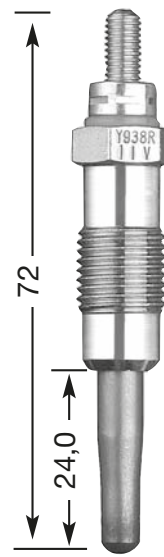

**Y-938 R**  
M 12 x 1.25  
12 Hex  
11 V

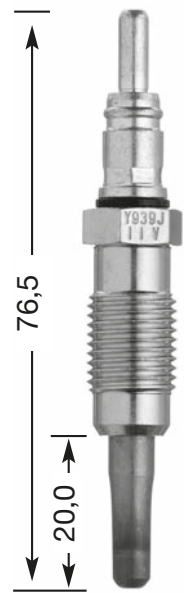

**Y-939 J**  
M 12 x 1.25  
12 Hex  
11 V  
**DP 43**

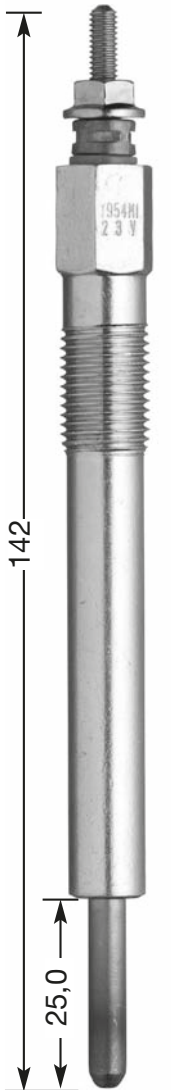

**Y-954 M1**  
M 12 x 1.25  
12 Hex  
23 V

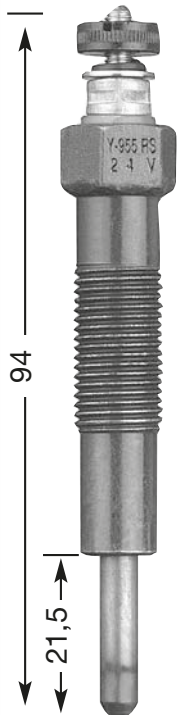

**Y-955 RS**  
M 12 x 1.25  
14 Hex  
24 V

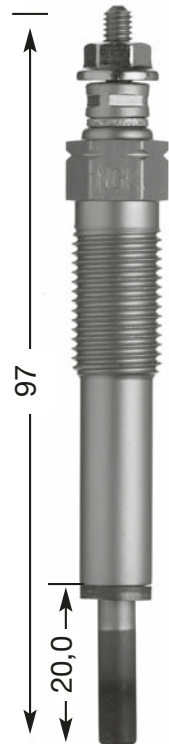

**Y-971 M**  
M 12 x 1.25  
12 Hex  
23 V

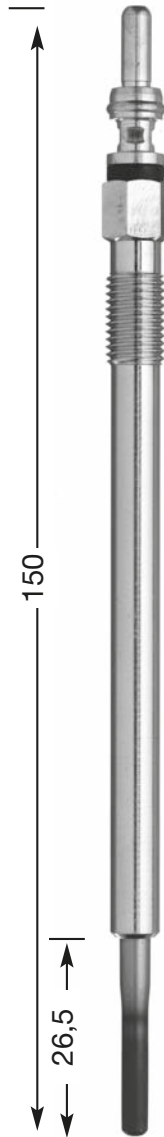

**Y-8002 AS**  
M 8 x 1.0  
8 Hex  
4,4 V  
**DP 51**

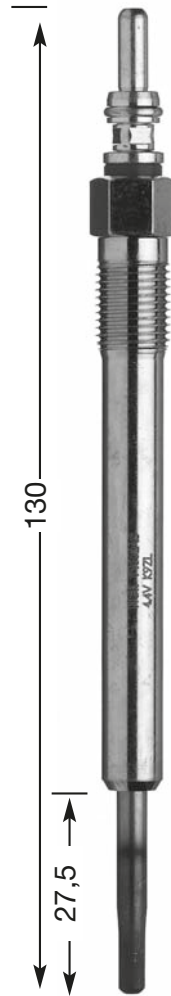

**Y1002 AS**  
M 10 x 1.0  
10 Hex  
4,4 V  
**DP 57**



**Y1005 J**  
M 10 x 1.0  
10 Hex  
11 V  
**DP 56**

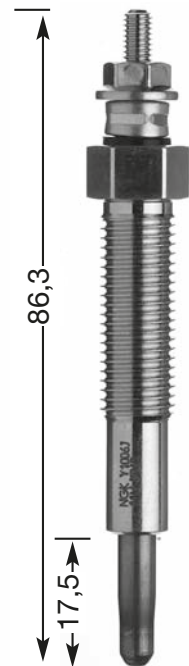

**Y1006 J**  
M 10 x 1.25  
12 Hex  
11 V





**Y1007 J**  
M 12 x 1.25  
12 Hex  
11 V  
**DP 59**

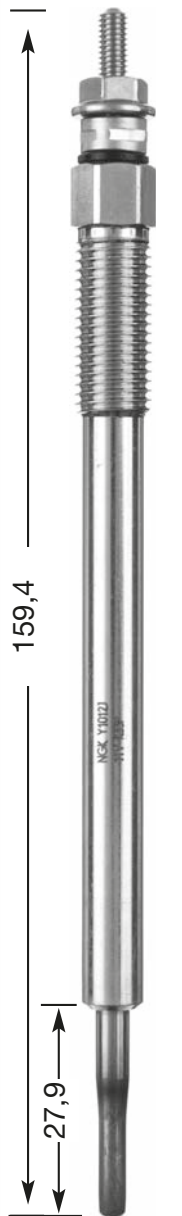

**Y1012 J**  
M 10 x 1.25  
10 Hex  
11 V  
**DP 65**



**Y1013 J**  
M 10 x 1.25  
12 Hex  
11 V  
**DP 63**

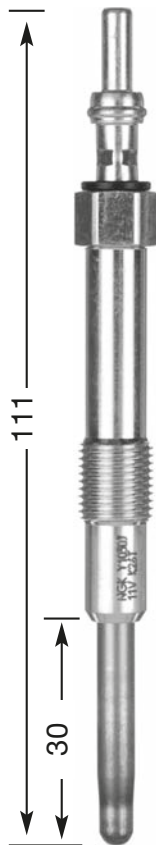

**Y1030 J**  
M 10 x 1.0  
10 Hex  
11 V  
**DP 70**

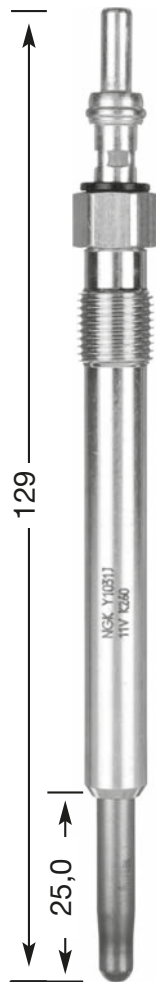

**Y1031 J**  
M 10 x 1.0  
10 Hex  
11 V  
**DP 71**

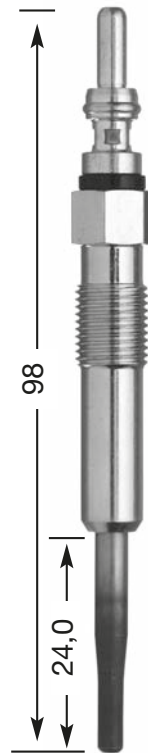

**Y1035 AS**  
M 10 x 1.0  
10 Hex  
4,4 V  
**DP 77**

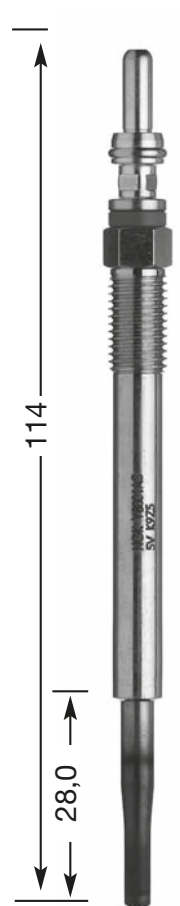

**Y8001 AS**  
M 8 x 1.0  
8 Hex  
5 V  
**DP 58**

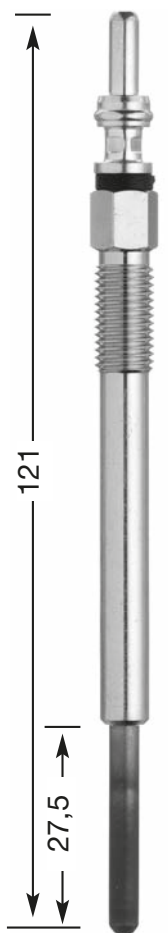

**Y8003 J**  
M 8 x 1.0  
8 Hex  
11 V  
**DP 62**

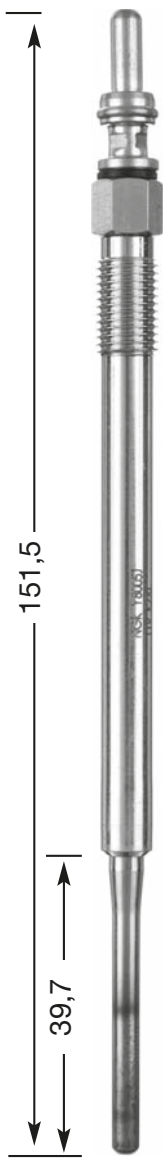

**Y8005 J**  
M 8 x 1.0  
8 Hex  
11 V  
**DP 64**

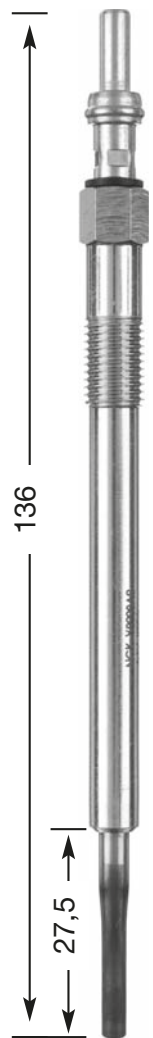

**Y8008 AS**  
M 8 x 1.0  
8 Hex  
11 V  
**DP 74**



**Y9001 AS**  
M 9 x 1.0  
9 Hex  
4,3 V  
**DP 72**

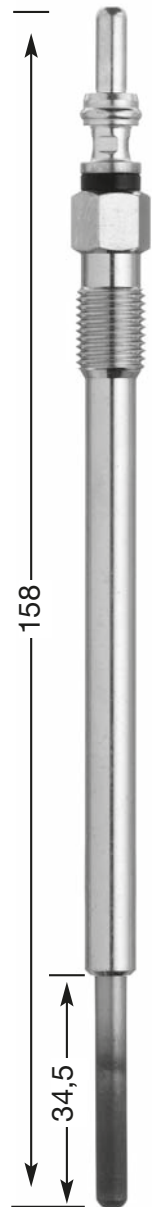

**Y-9003 AS**  
M 9 x 1.0  
9 Hex  
4,4 V  
**DP 78**

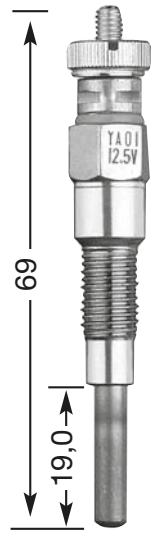

**YA 01**  
M 8 x 1.0  
10 Hex  
12,5 V

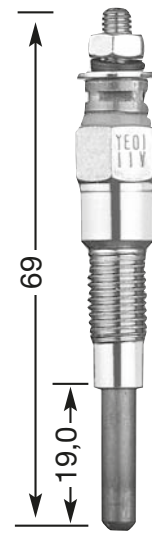

**YE 01**  
M 8 x 1.0  
10 Hex  
11 V

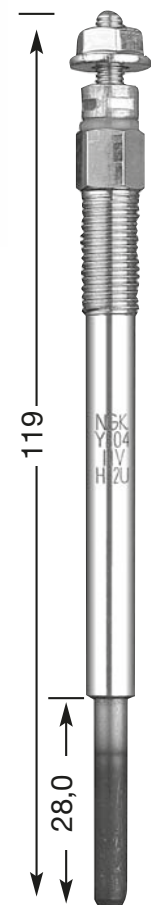

**YE 04**  
M 8 x 1.0  
8 Hex  
11 V  
**DP 40**

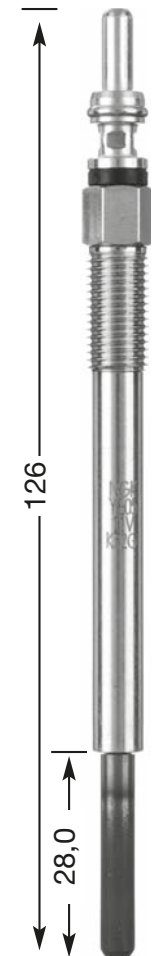

**YE 05**  
M 8 x 1.0  
8 Hex  
11 V  
**DP 73**

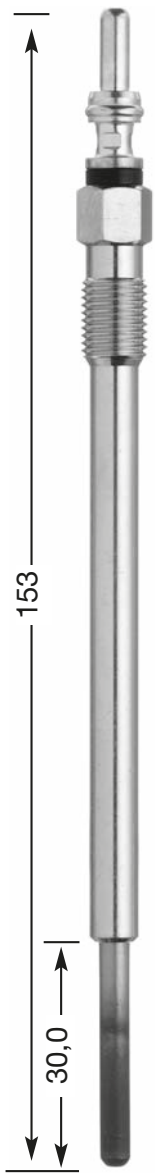

**YE 07**  
M 9 x 1.0  
9 Hex  
11 V

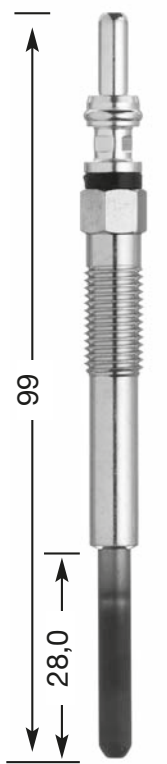

**YE 08**  
M 8 x 1.0  
8 Hex  
11 V

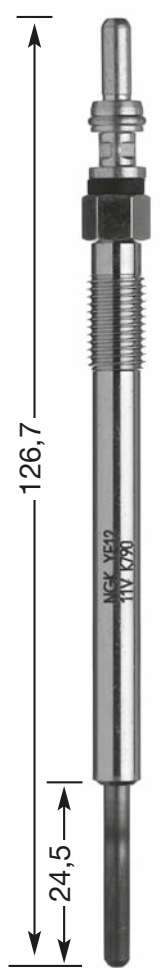

**YE 12**  
M 8 x 1.0  
8 Hex  
11 V

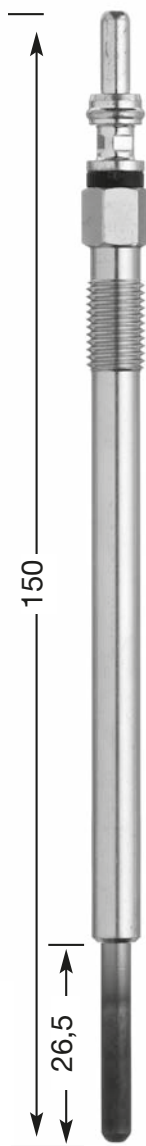

**YE 14**  
M 8 x 1.0  
8 Hex  
4,4 V  
**DP 48**



**YE 13**  
M 8 x 1.0  
8 Hex  
11,5 V

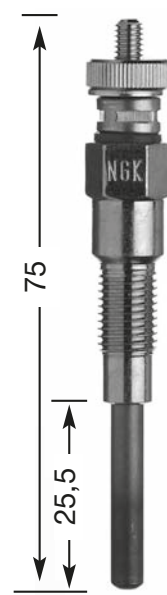

**YE 52**  
M 8 x 1.0  
10 Hex  
23 V

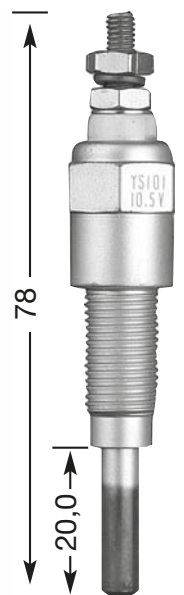

**YS 101**  
M 10 x 1.0  
14 Hex  
10,5 V

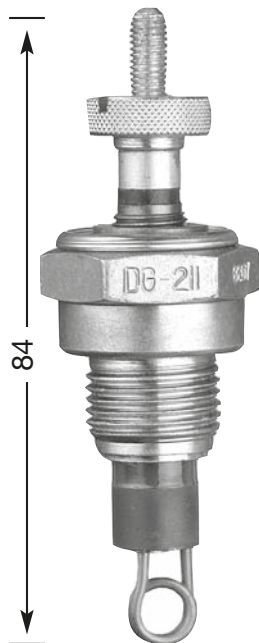

**DG-211**  
M 18 x 1.5  
25 Hex

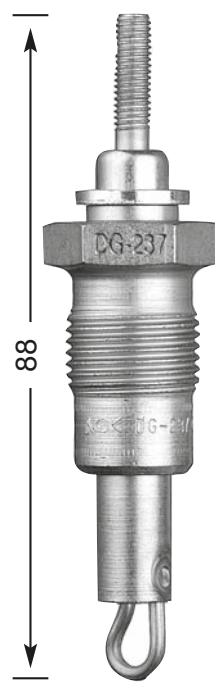

**DG-237**  
M 18 x 1.5  
21 Hex  
0,9 V

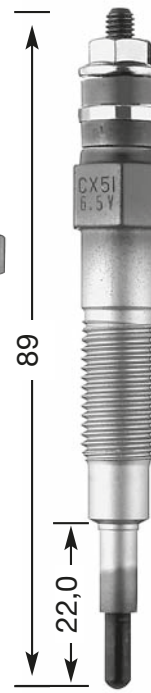

**CX 51**  
M 10 x 1.25  
10 Hex  
6,5 V

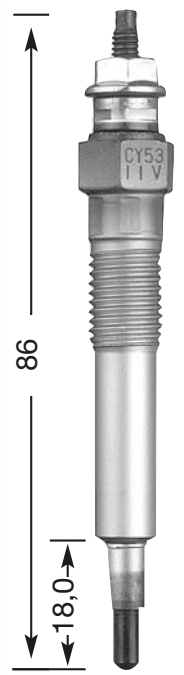

**CY 03**  
M 10 x 1.25  
12 Hex  
11 V

**DP 8**

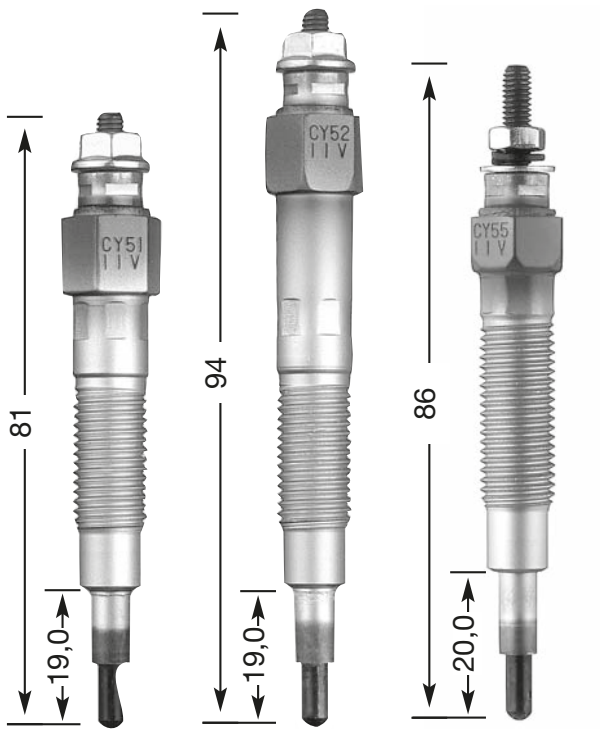

**CY 51**  
M 10 x 1.25  
12 Hex  
11 V

**CY 52**  
M 10 x 1.25  
12 Hex  
11 V

**CY 55**  
M 10 x 1.25  
12 Hex  
11 V

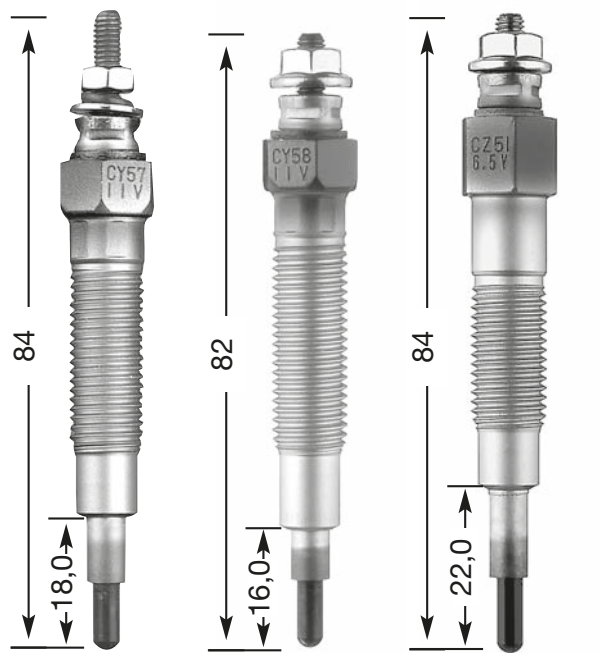

**CY 57**  
M 10 x 1.25  
12 Hex  
11 V

**CY 58**  
M 10 x 1.25  
12 Hex  
11 V

**CZ 51**  
M 10 x 1.25  
12 Hex  
6,5 V

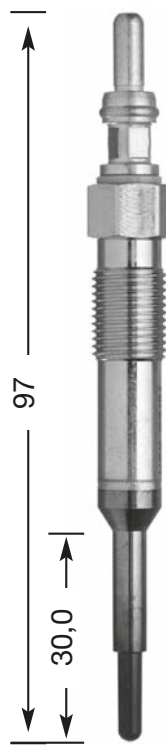

**CZ 104**  
M 10 x 1.0  
10 Hex  
7 V

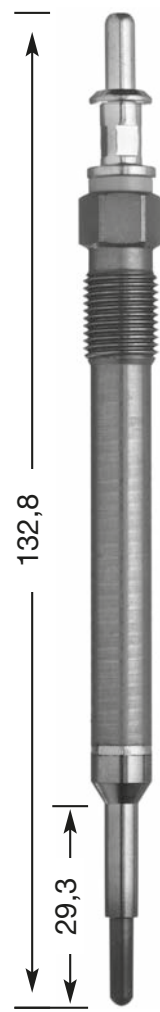

**CZ 106**  
M 10 x 1.0  
10 Hex  
7 V

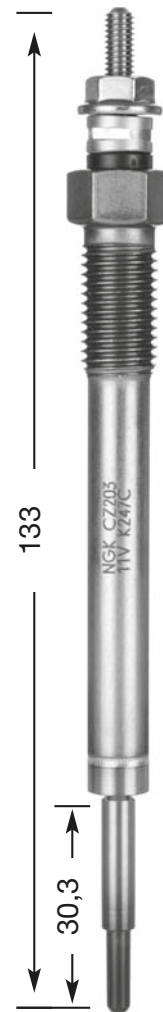

**CZ 203**  
M 10 x 1.25  
12 Hex  
11 V

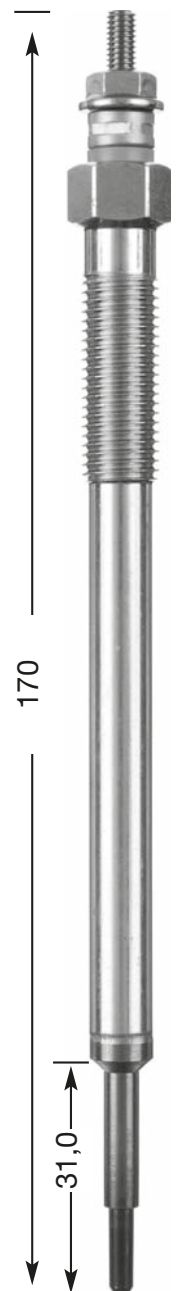

**CZ 251**  
M 10 x 1.25  
12 Hex  
11 V

**DP 21**

**DP 52**

**DP 53**

**DP 68**

**DP 76**



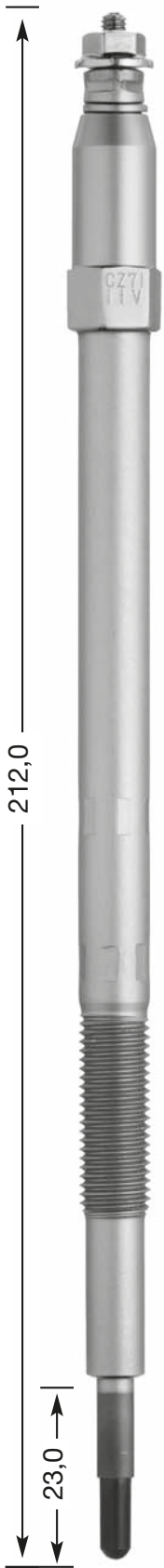

**CZ 258**  
 M 10 x 1.25  
 12 Hex  
 11 V

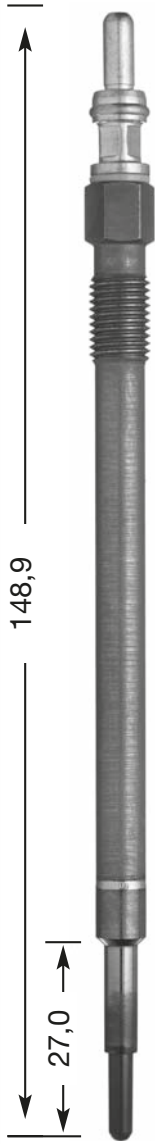

**CZ 303**  
 M 8 x 1.0  
 8 Hex  
 7 V  
**DP 54**

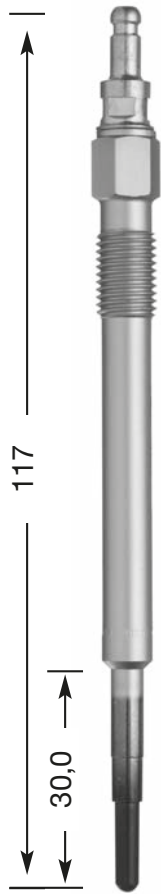

**CZ 304**  
 M 8 x 1.0  
 8 Hex  
 7 V  
**DP 55**

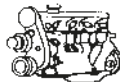

Code *l* kW

Cyl.



Stock-No.

V-TUNE

E-Power

LPG/CNG

**ABARTH**

500 1.4 T-Jet 16V		1.4	99	08.08 -		4	0,8	IKR9J8	93311		IKR9J8
500 Abarth		1.4	103	06.10 -		4	0,8	IKR9J8	93311		IKR9J8
Grande Punto 1,4 T-Jet 16V		1.4	132	09.09 -		4	0,8	IKR9J8	93311		IKR9J8
Grande Punto 1.4 T-Jet 16V		1.4	114	12.07 -	199A8000	4	0,8	IKR9J8	93311		IKR9J8
Punto EVO Abarth		1.4	120	06.10 -		4	0,8	IKR9J8	93311		IKR9J8

**ACURA**

RSX		2.0	147	02 - 03	K20A2	4	1,1	IFR7G-11KS	7746		IFR7G-11KS
RSX		2.0		02 - 02	K20A3	4	1,1	IZFR6K11	6994		IZFR6K11
SLX		3.2		96 - 97	6VD1	6	1,1	PFR5G-11	2647		PFR6G-11
SLX		3.5		98 -	6VE1	6	1,1	PFR5G-11	2647		PFR6G-11

**ALFA ROMEO****33**

33 i.e		1.3	65	02.94 - 10.94	AR307.32	4	0,7	BP6ES	7811	4	LPG 2
33 i.e Sport Wagon		1.3	65	02.94 - 10.94	AR307.32-301.68	4	0,7	BP6ES	7811	4	LPG 2
33 - 1.3 L		1.3		87 - 01.94	AR305.02-86-87	4	0,7	BP6ES	7811	4	LPG 2
33 i.e.		1.4	66	01.92 - 12.93	AR307.53	4	0,7	BP6ES	7811	4	LPG 2
33 i.e.; Cat.		1.5	74	12.90 - 93	AR307.51	4	0,7	BP6ES	7811	4	LPG 2
33 - 1.5 L		1.5	77	84 - 93	AR307.34-305.88	4	0,7	BP6ES	7811	4	LPG 2
33 i.e. all 1.7 Ltr.cat.		1.7	77	90 - 93	AR307.46-47	4	0,9	PFR6B	3500		PFR7B
33 i.e. - 1.7 L		1.7	85	88 - 93	AR305.50	4	0,7	BP6ES	7811	4	LPG 2
33 i.e.- 1.7 Ltr.16V		1.7	95	01.88 - 12.93	AR307.36-37	4	0,9	PFR6B	3500		PFR7B
33 TD		1.8	55	09.86 - 03.94		4	█	Y-909R	4602		
33 TD		1.8	62	09.86 - 03.94	VM HR-392	3	█	Y-909R	4602		
33 TD		1.8	62	02.90 - 03.94	VM 82 A	4	█	Y-909R	4602		
33 TD Sport Wagon		1.8	62	01.90 - 03.94	VM 96 A	4	█	Y-909R	4602		

**75**

75 TD		2.0	70	05.85 - 02.92	VM 80 A	4	█	Y-909R	4602		
75 i.Twin Spark		2.0	106	01.87 - 02.92	AR061.66 Cat.-062.24	4	0,7	BKP6ES	4930	17	LPG 3
75 TD		2.4	81	10.88 - 02.92	VM 81 A	4	█	Y-909R	4602		
75 i. V6		2.5	110	09.85 - 02.92	AR016.46-019.11 Cat.	6	0,8	BP7ES	2412		BPR8EIX
75 i. V6		3.0	133	01.87 - 02.92	AR061.20-061.24 Cat.	6	0,7	BP6ES	7811	4	LPG 2
75 i. V6		3.0	139	02.90 - 02.92	AR061.503	6	0,7	PGR6A	4984		PGR7A

**145**

145 i.e L		1.4	66	08.94 - 11.96	AR33.501	4	0,7	BP6ES	7811	4	LPG 2
145 i. 16V Twin Spark		1.4	76	04.97 - 12.01	AR33.503	4		BKR6EKPA + PMR7A	2513 +4259		
145 i.e L		1.6	76	08.94 - 11.96	AR33.201	4	0,7	BP6ES	7811	4	LPG 2
145 i. 16V Twin Spark L		1.6	88	04.96 - 12.01	AR67.601	4		BKR6EKPA + PMR7A	2513 +4259		
145 i.e 16V		1.7	95	08.94 - 11.96	AR33.401	4	0,9	PFR6B	3500		PFR7B
145 i. Twin Spark 16V- L		1.8	103	12.96 - 03.98	AR67.106	4		BKR6EKPA + PMR7A	2513 +4259		
145 i. 16V Twin Spark		1.8	106	03.98 - 12.01	AR32.201	4		BKR6EKPA + PMR7A	2513 +4259		
145 TD		1.9	66	04.94 - 09.96	AR67.501	4	█	Y-922R	4356	1	
145 TD		1.9	66	10.96 - 09.97	AR33.601	4	█	Y-922R	4356	1	
145 JTD		1.9	77	11.99 - 01.01	AR32.302 dal n. motore 1716459 →	4	█	Y-534J	3413	36	

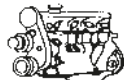
Code *ℓ* kW

Cyl.



Stock-No.

V-**LINE**  
100% FLOW INJECTION

LPG/CNG

**ALFA ROMEO****145**

145 JTD		1.9	77	02.99 - 10.99	AR32.302 fino a n. motore —>1716458	4		Y-747U	4694	26	
145 i. 16V T.S. Quadrifoglio		2.0	110	10.95 - 04.01	AR67.204	4		BKR6EKPA + PMR7A	2513 +4259		
145 16V T.S. Brazil		2.0	110	12.96 - 04.01		4		BKR6EKPA + PMR7A	2513 +4259		
145 i 2.0 16V T.S.		2.0	114	03.98 - 04.01	AR32.301	4		BKR6EKPA + PMR7A	2513 +4259		

**146**

146 i.e.		1.3	66	07.95 - 11.97	AR33.201	4	0,7	BP6ES	7811	4	LPG 2
146 i.e- L		1.4	66	08.94 - 02.97	AR33.501	4	0,7	BP6ES	7811	4	LPG 2
146 T.S.		1.4	76	11.96 - 12.01	AR33.503	4		BKR6EKPA + PMR7A	2513 +4259		
146 i Twin Spark 16V		1.4	76	02.97 - 03.98	AR33.503	4		BKR6EKPA + PMR7A	2513 +4259		
146 1.4i 16V Twin Spark		1.4	76	04.98 - 12.01	AR33.503	4		BKR6EKPA + PMR7A	2513 +4259		
146 i.e L		1.6	76	07.94 - 12.97	AR33.201	4	0,7	BP6ES	7811	4	LPG 2
146 i 16V Twin Spark L		1.6	88	04.96 - 12.01	AR67.601	4		BKR6EKPA + PMR7A	2513 +4259		
146		1.7	78	08.98 - 04.99	AR32.201	4		BKR6EKPA + PMR7A	2513 +4259		
146 i.e 16V		1.7	95	08.94 - 02.97	AR33.401	4	0,9	PFR6B	3500		PFR7B
146 i 16V Twin Spark L		1.8	103	02.97 - 12.01	AR67.106	4		BKR6EKPA + PMR7A	2513 +4259		
146 i. 16V Twin Spark		1.8	106	12.96 - 04.01	AR32.201	4		BKR6EKPA + PMR7A	2513 +4259		
146 TD		1.9	66	02.95 - 09.96	AR67 501	4		Y-922R	4356	1	
146 TD		1.9	66	10.96 - 09.97	AR33.601	4		Y-922R	4356	1	
146 JTD		1.9	77	11.99 - 01.01	AR32.302 dal n. motore 1716459 —>	4		Y-534J	3413	36	
146 JTD		1.9	77	02.99 - 10.99	AR32.302 fino a n. motore —>1716458	4		Y-747U	4694	26	
146 i. Twin Spark 16V- ti		2.0	110	02.96 - 04.01	AR67.204	4		BKR6EKPA + PMR7A	2513 +4259		
146 i 2.0 16V T.S.		2.0	114	03.98 - 12.01	AR32.301	4		BKR6EKPA + PMR7A	2513 +4259		

**147**

147 1.6 T.S. 16V		1.6	76	10.00 -	AR37.203	4		BKUR6ETB + CR7EKC	6992 +7004		
147 1.6 T.S. 16V		1.6	88	10.00 -	AR32.104	4		BKR6EKPA + PMR7A	2513 +4259		
147 1.9 JTD		1.9	74	11.00 - 05.03	182B9000	4		Y-534J	3413	36	
147 1.9 JTD		1.9	85	06.03 - 06.05	937A2000	4		Y-534J	3413	36	
147 1.9 JTDM		1.9	85	10.04 - 09.07	939A7000	4		Y1030J	90828	70	
147 1.9 JTDM 8V		1.9	88	07.05 -	937A3000	4		Y1030J	90828	70	
147 1.9 JTD 16V		1.9	93	09.03 - 05.05	937A4000	4		YE07	6092		
147 1.9 JTD 16V		1.9	100	10.04 -	192B1000	4		YE07	6092		
147 1.9 JTD 16V		1.9	103	11.03 -	192A5000	4		YE07	6092		

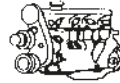

Code *l* kW

Cyl.

Stock-No.  
**VEFINE**  
BY-PROMOTER

LPG/CNG

**ALFA ROMEO****147**

147 1.9 JTD Mjet 16V		1.9	110	07.04 -	937A5000	4	<input checked="" type="checkbox"/>	YE07	6092		
147 2.0 T.S. 16V		2.0	110	10.00 -	AR 32310	4		BKR6EKPA + PMR7A	2513 +4259		
147 GTA		3.2	184	11.02 - 05.06	932A.000	6	0,9	PFR6B	3500		PFR7B

**155**

155 i.16 V T.S.		1.6	88	07.96 - 01.98	AR67.601	4		BKR6EKPA + PMR7A	2513 +4259		
155 i T.S.		1.7	86	02.92 - 04.93	AR67.103	4	0,7	BCP6ES	4930	17	LPG 3
155 i.T.S.		1.7	95	05.93 - 07.96	AR67.105	4	0,7	BCP6ES	4930	17	LPG 3
155 i.Twin Spark		1.8	93	02.92 - 07.96	AR67.102	4	0,7	BCP6ES	4930	17	LPG 3
155 i.T.S.		1.8	93	04.94 - 07.96	AR67.101-67.102	4	0,7	BCP6ES	4930	17	LPG 3
155 i.16 V T.S.		1.8	103	05.96 - 01.98	AR67.106	4		BKR6EKPA + PMR7A	2513 +4259		
155 TD		1.9	68	04.93 - 04.96	AR67.501	4	<input checked="" type="checkbox"/>	Y-924J	7906	1	
155 TD		2.0	66	08.93 - 04.96	AR67.502	4	<input checked="" type="checkbox"/>	Y-922R	4356	1	
155 i.T.S.L		2.0	104	02.92 - 02.95	AR67.201-67.202	4	0,7	BCP6ES	4930	17	LPG 3
155 i.Twin Spark		2.0	106	02.92 - 02.95	AR67.202	4	0,7	BCP6ES	4930	17	LPG 3
155 i.16V T.S.		2.0	110	06.94 - 01.98	AR67.204	4		BKR6EKPA + PMR7A	2513 +4259		
155 i Turbo 4x4		2.0	137	08.92 - 04.98	AR67.203	4		BP6ET	1263		LPG 2
155 TD		2.5	92	04.93 - 04.95	VM 425 CLIEA	4	<input checked="" type="checkbox"/>	Y-922R	4356	1	
155 TD		2.5	92	05.95 - 10.97	VM 425 CLIEA	4	<input checked="" type="checkbox"/>	Y-741U	6943	20	
155 i.		2.5	120	02.92 -	AR67.301	6	0,8	BPR7ES	2023	19	BPR8EIX
155 i. V6		2.5	120	02.92 - 04.95	AR67.301	6	0,8	BPR7ES	2023	19	BPR8EIX
155 i. V6		2.5	120	05.95 - 02.97	AR67.301	6	0,7	BP6ES	7811	4	LPG 2

**156**

156 16V T.S.		1.6	88	12.97 - 05.06	AR32.101	4		BKR6EKPA + PMR7A	2513 +4259		
156 16V T.S.		1.8	106	12.97 - 05.06	AR32.201	4		BKR6EKPA + PMR7A	2513 +4259		
156 JTD		1.9	77	10.97 - 09.00	AR32.302	4	<input checked="" type="checkbox"/>	Y-747U	4694	26	
156 JTD		1.9	81	10.00 - 05.01	AR37.101	4	<input checked="" type="checkbox"/>	Y-534J	3413	36	
156 JTD		1.9	85	05.01 - 05	937A2000	4	<input checked="" type="checkbox"/>	Y-534J	3413	36	
156 1.9 JTD 16V		1.9	103	11.02 - 09.05	192A5000	4	<input checked="" type="checkbox"/>	YE07	6092		
156 1.9 JTD 16V		1.9	110	07.04 - 09.05	937A5000	4	<input checked="" type="checkbox"/>	YE07	6092		
156 16V T.S		2.0	114	12.97 - 12.02	AR32.301	4		BKR6EKPA + PMR7A	2513 +4259		
156 16V T.S. Selespeed		2.0	114	05.99 - 12.02	AR32.301	4		BKR6EKPA + PMR7A	2513 +4259		
156 JTS		2.0	121	11.01 - 05.06	937A1000	4		BKR6EKPA	2513		
156 JTD		2.4	100	10.97 - 09.00	AR32.501	5	<input checked="" type="checkbox"/>	Y-747U	4694	26	
156 JTD		2.4	103	10.00 - 02.02	839A6000	5	<input checked="" type="checkbox"/>	Y-534J	3413	36	
156 JTD		2.4	110	03.02 - 01.04	841C000	5	<input checked="" type="checkbox"/>	Y-534J	3413	36	
156 1.9 JTD 20V		2.4	129	11.03 - 05.06	841G000	5	<input checked="" type="checkbox"/>	YE07	6092		
156 24V		2.5	140	10.97 - 05.06	AR32.401	6	0,9	PFR6B	3500		PFR7B
156 GTA		3.2	184	11.02 - 05.06	932A.000	6	0,9	PFR6B	3500		PFR7B

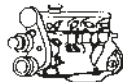
Code *ℓ* kW

Cyl.



Stock-No.



LPG/CNG

**ALFA ROMEO****159**

159 1750 TBi		1.8	147	05.09 -	939B1000	4	0,6	ILKAR7D6G	93607		ILKAR7D6G
159 1.9 JTDM 8V		1.9	85	09.05 -	937A7000 / 939A7000	4		Y1030J	90828	70	
159 1.9 JTDM 8V		1.9	88	09.05 -	939A1000	4		Y1030J	90828	70	
159 1.9 JTDM 16V		1.9	100	09.05 - 12.10	937A8000 / 939A8000	4		YE07	6092		
159 1.9 JTDm 16V		1.9	110	07.05 -	939A2000	4		YE07	6092		
159 1.9 JTS 16V		1.9	118	07.05 -	939A6000	4		FR5CP	6368		
159 2.0 JTDM		2.0	100	06.10 - 11.11	939B4000	4		Y9003AS	94251	78	
159 2.0 JTDM		2.0	120	05.09 - 11.11	844A2000	4		Y9003AS	94251	78	
159 2.0 JTDM		2.0	125	03.09 - 11.11	939B3000	4		Y9003AS	94251	78	
159 2.2 JTS 16V		2.2	136	07.05 -	939A5000	4		FR5CP	6368		
159 2.4 JTDm 20V		2.4	147	12.05 - 04.07	939A3000	5		YE07	6092		
159 2.4 JTDm 20V		2.4	154	05.07 - 12.08	939A9000	5		YE07	6092		

**164**

164 i.T.S.		2.0	102	06.87 - 09.92	AR064.16Cat-064.20	4	0,7	BCP6ES	4930	17	LPG 3
164 i.T.S Super / Super L		2.0	106	07.94 - 10.98	AR67.201-67202	4	0,7	BCP6ES	4930	17	LPG 3
164 i.e. Turbo		2.0	126	01.88 - 09.92	AR064.76	4	0,8	BPR7ES	2023	19	BPR8EIX
164 i. V6 Turbo Super		2.0	148	03.91 - 10.98	AR64.102	6	0,8	BP7ES	2412		BPR8EIX
164 i.		2.0		03.91 -			0,8	BP7ES	2412		BPR8EIX
164 TD		2.5	85	06.87 - 08.92	VM 84 A	4		Y-909R	4602		
164 TD Super		2.5	92	09.92 - 04.95	VM 425-SLIRA	4		Y-922R	4356	1	
164 TD		2.5	92	05.95 - 10.98	VM 425 SLIRA	4		Y-741U	6943	20	
164 i. V6 Super		3.0	132	01.96 -		6	0,7	PGR6A	4984		PGR7A
164 i. V6 12V		3.0	138	01.90 - 10.98	AR64.305	6	0,7	BP6ES	7811	4	LPG 2
164 i. V6 24V CF2		3.0	155	01.87 - 92	AR64.301	6	0,7	PGR6A	4984		PGR7A
164 i. V6 12V		3.0	155	92 - 10.98	AR66.301	6	0,9	PFR6B	3500		PFR7B
164 i. V6 24V Super		3.0	155	07.94 - 10.98	AR64.304-64.308	6	0,9	PFR6B	3500		PFR7B
164 i. V6 QV		3.0	169	- 10.98	AR16.102	6	0,7	PGR6A	4984		PGR7A
164 i. Q.4		3.0	171	01.90 - 10.98	AR64.304	6	0,9	PFR6B	3500		PFR7B
164 12V		3.0		06.87 - 09.93	06410, 06412	6	0,7	B7ES	1111		BR8EIX

**166**

166 2.0 T.S. 16V		2.0	114	11.98 - 06.06	AR34.103	4		BKR6EKPA	2513		
								+ PMR7A	+4259		
166 2.0 TS		2.0	125	11.03 - 06.06	AR36301	4		BKR6EKPA	2513		
								+ PMR7A	+4259		
166 2.0 V6 Turbo Super		2.0	151	11.98 - 06.06	AR34.102	6	0,8	BP6E	5637	4	LPG 2
166 24V V6 Brazil		2.0	151	10.98 - 06.06			0,9	PFR6B	3500		PFR7B
166 2.4 JTD		2.4	100	10.98 - 10.00	AR34.202	5		Y-747U	4694	26	
166 2.4 JTD		2.4	103	11.00 - 03.02	839A600	5		Y-534J	3413	36	
166 2.4 JTD		2.4	110	04.02 - 10.03	841C000	5		Y-534J	3413	36	
166 2.4 JTD		2.4	129	10.03 - 06.08	841G000 / 841H000	5		YE07	6092		
166 2.4 JTD Mjet 20V		2.4	132	07.06 - 06.08	936B000 / 841M000	5		YE07	6092		
166 2.4 JTD Mjet 20V		2.4	136	07.05 - 06.08	936B000 / 841M000	5		YE07	6092		
166 2.5 I V6 24V		2.5	140	11.98 - 06.06	AR34.201	6	0,9	PFR6B	3500		PFR7B
166 3.0 I V6 24V		3.0	162	11.98 - 06.06	AR34.301	6	0,9	PFR6B	3500		PFR7B
166 3.2 V6 24V		3.2	176	11.03 - 06.06	936A6000	6	0,9	PFR6B	3500		PFR7B

**BRERA**

Brera 1750 TBi		1.8	147	03.09 -	939B1000	4	0,6	ILKAR7D6G	93607		ILKAR7D6G
Brera 2.0 JTDM		2.0	120	03.08 - 12.11	844A2000	4		Y9003AS	94251	78	
Brera 2.0 JTDM		2.0	125	03.09 -	939B3000	4		Y9003AS	94251	78	

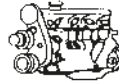
Code *l* kW

Cyl.

Stock-No.  
**VEFINE**  
BY-PROMOTER

LPG/CNG

**ALFA ROMEO****BRERA**

Brera 2.2 JTS		2.2	136	09.05 -	939A5000	4		FR5CP	6368		
Brera 2.4 JTDM 20V		2.4	147	01.06 -	939A3000	5	☑	YE07	6092		

**GIULIETTA**

Giulietta 1.4 TB	940	1.4	85	04.10 -	198A6000	4	0,8	IKR9J8	93311		IKR9J8
Giulietta 1.4 TB	940	1.4	88	03.10 -	198A4000	4	0,8	IKR9J8	93311		IKR9J8
Giulietta 1.4 TB BiFuel	940	1.4	88	12.11 -	198A4000	4	0,8	IKR9J8	93311		IKR9J8
Giulietta 1.4 TB	940	1.4	120	04.10 -	955A8000	4	0,8	IKR9J8	93311		IKR9J8
Giulietta 1.4 TB	940	1.4	125	03.10 -	940A2000	4	0,8	IKR9J8	93311		IKR9J8
Giulietta 1,6 JTDM	940	1.6	77	03.10 -	940A3000	4	☑	Y9003AS	94251	78	
Giulietta 1750 Tbi Quadrifoglio Verde	940	1.8	173	03.10 -	940A1000	4	0,6	ILKAR7D6G	93607		ILKAR7D6G
Giulietta 2.0 JTDM	940	2.0	100	04.10 -	940A8000	4	☑	Y9003AS	94251	78	
Giulietta 2.0 JTDM	940	2.0	103	04.10 -	940A5000	4	☑	Y9003AS	94251	78	
Giulietta 2.0 JTDM	940	2.0	120	04.10 -	940A7000	4	☑	Y9003AS	94251	78	
Giulietta 2.0 JTDM	940	2.0	125	03.10 -	940A4000	4	☑	Y9003AS	94251	78	

**GT**

GT 1.8 16V TS		1.8	103	12.03 -	AR32205	4		BKR6EKPA + PMR7A	2513 +4259		
GT 1.9 JTDM 16V		1.9	110	12.03 -	937A5000	4	☑	YE07	6092		
GT 1.9 JTDM 16V		1.9	125	05.08 -	937A6000	4	☑	YE07	6092		
GT 2.0 JTS		2.0	121	12.03 -	937A1000	4		BKR6EKPA	2513		
GT		3.2	176	12.03 - 12.04	936A6000	6	0,9	PFR6B	3500		PFR7B

**GTV**

GTV i 16V Twin Spark		1.8	106	06.98 - 06.02	AR32.201	4		BKR6EKPA + PMR7A	2513 +4259		
GTV T.S. 16V		2.0	110	04.95 - 05.98	AR16.201	4		BKR6EKPA + PMR7A	2513 +4259		
GTV 2.0 L Twin Spark -16V		2.0	110	06.98 -	AR32.301	4		BKR6EKPA + PMR7A	2513 +4259		
GTV 2.0 JTS 16V		2.0	121	06.03 -	937A1000	4		BKR6EKPA	2513		
GTV V6 Turbo		2.0	147	04.95 - 05.98	AR16.202	6	0,8	BP7ES	2412		BPR8EIX
GTV 2.0 L V6 turbo L		2.0	148	06.98 - 12.99	AR16.202	6	0,9	BPR6E	6464	2	LPG 2
GTV V6 12V		2.0	151	09.97 - 12.00		6	0,8	BPR7ES	2023	19	BPR8EIX
GTV V6 24V- L		3.0	160	11.96 - 12.00	AR16.102	6	0,9	PFR6B	3500		PFR7B
GTV V6 24V		3.0	162	02.97 - 05.98	AR67.601	6	0,9	PFR6B	3500		PFR7B
GTV V6 24V		3.2	176	06.03 -	936A6000	6	0,9	PFR6B	3500		PFR7B

**MITO**

MITO 0.9 Twin Air	955	0.9	63	07.11 -	312A2000	2	0,8	ILKR9G8	97168		ILKR9G8
MITO 1.3 JTDM 16V Eco	955	1.3	62	01.11 -	199B4000	4	☑	Y9001AS	97719	72	
MITO 1.3 JTDM	955	1.3	66	10.08 -	199A3000	4	☑	Y8003J	97256	62	
MITO 1.3 JTDM 16V	955	1.3	70	10.09 -	199B1000	4	☑	Y9001AS	97719	72	LPG 8
MITO 1.4	955	1.4	51	05.11 -	955A9000	4	1,0	ZKR7A-10	1691		IKR9F8
MITO 1.4	955	1.4	57	03.11 -	350A1000	4	1,0	ZKR7A-10	1691		IKR9F8
MITO 1.4	955	1.4	58	09.08 -	955A1000	4	1,0	ZKR7A-10	1691		LPG 8
MITO 1.4	955	1.4	70	09.08 -	199A6000	4	1,0	ZKR7A-10	1691		LPG 8
MITO 1.4 16V Multiair	955	1.4	77	10.09 -	955A6000	4	1,0	DCPR7E-N-10	4983		IKR9F8
MITO 1.4 T-Jet	955	1.4	88	09.08 -	198A4000	4	0,8	IKR9J8	93311		IKR9J8
MITO 1.4 T-Jet Bifuel LPG	955	1.4	88	10.09 -	198A4000	4	0,8	IKR9J8	93311		IKR9J8
MITO 1.4 TB 16V Multiair	955	1.4	99	08.09 -	955A2000 / 955A7000	4	0,8	IKR9J8	93311		IKR9J8
MITO 1.4 T-Jet	955	1.4	110	09.08 - 06.11	198A1000	4	0,8	IKR9J8	93311		IKR9J8

Code *l* kW

Cyl.



Stock-No.



LPG/CNG

**ALFA ROMEO****MITO**

MITO 1.4 TB	955	1.4	114	09.08 -	199A8000	4	0,8	IKR9J8	93311		IKR9J8
MITO 1.4 TB	955	1.4	120	10.09 -	955A8000	4	0,8	IKR9J8	93311		IKR9J8
MITO 1.4 TB	955	1.4	125	12.09 -	940A2000	4	0,8	IKR9J8	93311		IKR9J8
MITO 1.6 JTDM 16V	955	1.6	85	08.08 -	955A4000	4	<input checked="" type="checkbox"/>	Y9003AS	94251	78	
MITO 1.6 JTDM 16V	955	1.6	88	08.08 -	955A3000	4	<input checked="" type="checkbox"/>	Y9003AS	94251	78	

**SPIDER**

Spider 16V T.S.		1.8	106	05.98 - 03.01	AR32.201	4		BKR6EKPA + PMR7A	2513 +4259		
Spider 1750 Tbi		1.8	147	03.09 -	939B1000	4	0,6	ILKAR7D6G	93607		ILKAR7D6G
Spider i.		2.0	86	01.90 - 12.94	AR015.44-88-90 Cat.	4	0,7	BP6ES	7811	4	ILKAR7D6G
Spider 16V T.S.		2.0	110	04.95 - 05.98	AR16.201	4		BKR6EKPA + PMR7A	2513 +4259		ILKAR7D6G
Spider 16V T.S.		2.0	114	06.98 -	AR32.301	4		BKR6EKPA + PMR7A	2513 +4259		
Spider 2.0 JTDM		2.0	120	12.11 -	844A2000	4	<input checked="" type="checkbox"/>	Y9003AS	94251	78	
Spider 2.0 JTS 16V		2.0	121	06.03 -	937A1000	4		BKR6EKPA	2513		
Spider 2.0 JTDM		2.0	125	12.11 -	939B3000	4	<input checked="" type="checkbox"/>	Y9003AS	94251	78	
Spider i V6 turbo		2.0	147	06.98 - 12.99	AR16.202	6	0,9	BPR6E	6464	2	LPG 2
Spider 2.2 JTS		2.2	136	01.06 -	939A5000	4		FR5CP	6368		
Spider 2.4 JTDm		2.4	147	02.06 -	939A3000	5	<input checked="" type="checkbox"/>	YE07	6092		
Spider 2.4 JTDm		2.4	154	03.08 -	939A9000	5	<input checked="" type="checkbox"/>	YE07	6092		
Spider i V6 12V		3.0	140	04.95 - 05.98	AR16.101-16.199	6	0,8	BPR6ES	7822	2	LPG 2
Spider 3.0 V6 24V		3.0	165	06.98 - 04	AR16.102	6	0,9	PFR6B	3500		PFR7B
Spider 3.2 V6 24V		3.2	176	06.03 -	936A6000	6	0,9	PFR6B	3500		PFR7B

**SZ**

SZ V6 / RZ V6		3.0	152	03.90 - 05.96	AR64.304	6	0,7	PGR6A	4984		PGR7A
---------------	--	-----	-----	---------------	----------	---	-----	-------	------	--	-------

**ALPINA****B 3**

B 3	E36	3.0	184	04.93 - 03.96	M50B30	6		BKR6EK	2288	20	LPG 1
B 3	E36	3.2	195	04.96 - 03.99	S52B32	6		BKR6EK	2288	20	LPG 1
B 3 3.2	E36	3.2	195	04.96 - 03.99	S52B32	6		BKR6EK	2288	20	LPG 1
B 3 3.3	E46	3.3	206	03.99 - 01.05	S52B33	6		BKR6EQUP	3199	30	LPG 1
B 3 S	E46	3.3	224	08.02 - 01.06	S52B33	6		BKR6EQUP	3199	30	LPG 1

**B 5**

B 5	E60	4.4	368	03.05 -	S62B44 H1/2	8	0,6	PFR7B	4853		PFR8B
B 5 Biturbo	F10	4.4	373	10 -	M1	8	0,8	SIZKBR8A8HS	1555		
B 5 S	E60	4.4	390	07 -	S62B44 H1/2	8	0,6	PFR7B	4853		PFR8B

**B 6**

B 6	E64	4.4	368	10.05 -	S62B44 H1/2	8	0,6	PFR7B	4853		PFR8B
B 6 S	E64	4.4	390	07 -	S62B44 H1/2	8	0,6	PFR7B	4853		PFR8B

**B 7**

B 7	E65	4.4	368	03.05 -	S62B44 H1/2	8	0,6	PFR7B	4853		PFR8B
B 7 Biturbo	F01	4.4	373	05.09 -	M1	8	0,8	SIZKBR8A8HS	1555		

**B 8**

B 8	E36	4.6	245	01.95 - 11.98	M62B46	8		BKR6EK	2288	20	LPG 1
-----	-----	-----	-----	---------------	--------	---	--	--------	------	----	-------

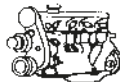

Code *l* kW

Cyl.



Stock-No.

**ALPINA****B 10**

B 10 3.2	E39	3.2	191	08.97 - 12.98	S52B32	6		BKR6EK	2288	20	LPG 1
B 10 3.3	E39	3.3	206	02.99 - 10.03	S52B33	6		BKR6EQU	3199	30	LPG 1
B 10 3.5	E34	3.5	187	04.88 - 12.92	B11/3	6	0,8	BPR6ES	7822	2	LPG 2
B 10 3.5 Biturbo	E34	3.5	265	08.89 - 03.94	B7/5	6	0,8	BPR6ES	7822	2	LPG 2
B 10 4.0	E34	4.0	232	04.93 - 08.95	F1	8		BKR6EQU	3199	30	LPG 1
B 10 4.6	E34	4.6	250	03.94 - 04.96	F2	8		BKR6EQU	3199	30	LPG 1
B 10 V8	E39	4.6	250	12.96 - 10.98	M62B46	8		BKR6EK	2288	20	LPG 1
B 10 V8	E39	4.6	255	10.98 - 08.00	M62B46	8		BKR6EQU	3199	30	LPG 1
B 10 V8S	E39	4.8	276	01.02 - 12.03	M62B48	8		BKR6EQU	3199	30	LPG 1

**B 12**

B 12 5.7 E-Kat	E38	5.7	285	12.95 - 09.98	M73B57	12		BKR6EK	2288	20	LPG 1
B 12 6.0 E-Kat	E38	6.0	316	06.99 - 07.01	M73B60	12		BKR6EQU	3199	30	LPG 1

**D 3**

D 3	E90	2.0	147	02.07 -	N47D20 L1	4	<input checked="" type="checkbox"/>	Y-547AS	5968	47	
-----	-----	-----	-----	---------	-----------	---	-------------------------------------	---------	------	----	--

**ROADSTER**

Roadster S	E85	3.4	221	07.03 - 12.05	E5/2	6		BKR6EQU	3199	30	LPG 1
Roadster V8	E52	4.8	280	06.02 - 10.03	S62 B48	8		BKR6EQU	3199	30	LPG 1

**ARO**

Spartana		1.2	40	97 -	C3GD7	4	0,9	BP5ESZ	4691		LPG 2
----------	--	-----	----	------	-------	---	-----	--------	------	--	-------

**ASIA MOTORS**

Rocsta		1.8	57	02.94 - 12.97	F8	4	0,9	BPR5ES	7422	6	LPG 2
Rocsta		2.2		03.94 - 12.97	R2	4	<input checked="" type="checkbox"/>	Y-107R	1229		

**ASTON MARTIN**

DB7		3.2	250	09.94 - 06.99	DOHC	6	0,8	BCPR7ES	3330		BCPR7EIX
DB7		5.9		07.99 - 11.00	DOHC	12	1,3	PTR6D-13	5598		LPG 5
DB7		5.9		11.00 -	DOHC	12	1,3	PTR5D-13	6644		
Turbo 24V Coupé, Cabriolet		3.2	246	95 -		6	0,7	BCPR7ES	3330		BCPR7EIX
48V V12		6.0	420	04.00 -		12	1,0	PTR5D-10	3784	31	LPG 5
Vanquish		5.9		06.01 -	AM 702	12	1,3	PTR6D-13	5598		LPG 5
Vantage		5.3	410	08.93 -	10.2:1Comp(Zagato)	8	0,8	BCR8ES	5430		
Virage / Volante		5.3		02.90 - 01.98	V8 32V	8	0,8	BCPR6E	1269	12	LPG 3

**AUDI****80 4**

80 (4) 1.6	B4	1.6	52	08.91 - 06.94	ABM	4		BUR5ET	3377	22	LPG 2
80 (4) 1.6	B4	1.6	74	06.93 - 07.95	ADA	4		BUR6ET	3172	1	LPG 2
80 (4) 1.9 TD	B4	1.9	55	09.91 - 07.95	AAZ	4	<input checked="" type="checkbox"/>	Y-918J	6285		
80 (4) 1.9 TDI	B4	1.9	66	09.91 - 07.95	1Z	4	<input checked="" type="checkbox"/>	Y-732J	5605		
80 (4) 2.0	B4	2.0	66	09.91 - 06.95	ABT	4		BUR6ET	3172	1	LPG 2
80 (4) 2.0 E	B4	2.0	85	09.91 - 07.95	ABK	4		BUR6ET	3172	1	LPG 2
80 (4) 2.0 E 16V	B4	2.0	103	08.92 - 07.95	ACE	4		BKUR7ET	7873		PFR7Q
80 (4) 2.3 E	B4	2.3	98	09.91 - 12.94	NG	5		BPR5EKU	5685		LPG 2
80 (4) 2.6 E	B4	2.6	110	07.92 - 07.95	ABC	6		BKUR6ET-10	2397	24	LPG 1
80 (4) 2.8 E	B4	2.8	128	09.91 - 07.95	AAH	6		BKUR6ET-10	2397	24	LPG 1
80 (4) S2 quattro	B4	2.2	169	02.93 - 07.95	ABY	5	0,6	PFR7B	4853		PFR8B

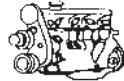
Code *ℓ* kW

Cyl.

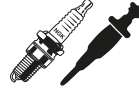

Stock-No.



LPG/CNG

**AUDI****80 4**

80 (4) avant RS2 quattro	B4	2.2	232	03.94 - 07.95	ADU	5	0,6	PFR7B	4853		PFR8B
--------------------------	----	-----	-----	---------------	-----	---	-----	-------	------	--	-------

**100 4**

100 (4) 2.0	4A/C4	2.0	74	12.90 - 07.94	AAE	4		BUR6ET	3172	1	LPG 2
100 (4) 2.0 E	4A/C4	2.0	85	12.90 - 12.92	AAD	4		BUR6ET	3172	1	LPG 2
100 (4) 2.0 E	4A/C4	2.0	85	01.93 - 07.94	ABK	4		BUR6ET	3172	1	LPG 2
100 (4) 2.0 E 16V	4A/C4	2.0	103	01.92 - 07.94	ACE	4		BKUR7ET	7873		PFR7Q
100 (4) 2.2 S4 quattro	4A/C4	2.2	169	08.91 - 07.94	AAN	5	0,6	PFR7B	4853		PFR8B
100 (4) 2.3 E	4A/C4	2.3	98	12.90 - 06.94	AAR	5		BPR5EKU	5685		LPG 2
100 (4) 2.4 D	4A/C4	2.4	60	12.90 - 07.94	AAS	5	☑	Y-918J	6285		
100 (4) 2.5 TDI	4A/C4	2.5	85	12.90 - 07.94	AAT	5	☑	Y-732J	5605		
100 (4) 2.5 TDI	4A/C4	2.5	85	12.90 - 07.92	ABP	5	☑	Y-732J	5605		
100 (4) 2.6 E	4A/C4	2.6	110	03.92 - 07.94	ABC	6		BKUR6ET-10	2397	24	LPG 1
100 (4) 2.8 E	4A/C4	2.8	128	12.90 - 07.94	AAH	6		BKUR6ET-10	2397	24	LPG 1
100 (4) 4.2 V8 S4 quattro	4A/C4	4.2	206	10.92 - 07.94	ABH	8	0,8	BUR6EFSZ	6837		
100 (4) 4.2 V8 S4 quattro	4A/C4	4.2	213	03.94 - 06.94	AEC	8	0,8	BUR6EFSZ	6837		

**A 1**

A 1 1.2 TFSI	8X1 / 8XA	1.2	63	05.10 -	CBZA	4	0,7	IZFR6P7	97153		IZFR6P7
A 1 1.4 TFSI	8X1 / 8XA	1.4	90	05.10 -	CAXA	4	0,9	PZFR6R	5758		PZFR6R
A 1 1.4 TFSI	8X1 / 8XA	1.4	136	11.10 -	CAVG	4	0,8	PZFR6R8EG	96498		PZFR6R8EG
A 1 1.6 TDI	8X1 / 8XA	1.6	66	11.10 -	CAYB	4	☑	Y1002AS	8888	57	
A 1 1.6 TDI	8X1 / 8XA	1.6	77	05.10 -	CAYC	4	☑	Y1002AS	8888	57	
A 1 2.0 TDI	8X1 / 8XA	2.0	100	05.12 -	CFHB	4	☑	Y1002AS	8888	57	
A 1 2.0 TDI	8X1 / 8XA	2.0	105	08.11 -	CFHD	4	☑	Y1002AS	8888	57	
A 1 quattro 2.0 TFSI	8X1	2.0	188	03.12 -	CDLH	4	0,8	PFR7S8EG	1675		PFR8S8EG

**A 2**

A 2 1.2 TDI	8Z0	1.2	45	03.01 - 08.05	ANY	3	☑	Y-741U	6943	20	
A 2 1.4	8Z0	1.4	55	06.00 - 04.02	AUA	4		BKUR6ET-10	2397	24	LPG 1
A 2 1.4	8Z0	1.4	55	05.02 - 08.05	BBY	4		BKUR6ET-10	2397	24	LPG 1
A 2 1.4 TDI	8Z0	1.4	55	06.00 - 08.03	AMF	3	☑	Y-741U	6943	20	
A 2 1.4 TDI	8Z0	1.4	55	09.03 - 08.05	BHC	3	☑	Y-741U	6943	20	
A 2 1.4 TDI	8Z0	1.4	66	11.03 - 08.05	ATL	3	☑	Y-607AS	7560	50	
A 2 1.6 FSI	8Z0	1.6	81	05.02 - 08.05	BAD	4		ZFR6S-Q	6449		ZFR6S-Q

**A 3 1**

A 3 (1) 1.6	8L1	1.6	74	09.96 - 06.01	AEH	4		BKUR6ET-10	2397	24	LPG 1
A 3 (1) 1.6	8L1	1.6	74	08.97 - 06.03	AKL	4		BKUR6ET-10	2397	24	LPG 1
A 3 (1) 1.6	8L1	1.6	74	06.99 - 08.00	APF	4		BKUR6ET-10	2397	24	LPG 1
A 3 (1) 1.6	8L1	1.6	75	05.00 - 04.02	AVU	4		BKUR6ET-10	2397	24	LPG 1
A 3 (1) 1.6	8L1	1.6	75	05.02 - 06.03	BFQ	4		BKUR6ET-10	2397	24	LPG 1
A 3 (1) 1.8	8L1	1.8	92	09.96 - 08.00	AGN	4		BKUR6ET-10	2397	24	LPG 1
A 3 (1) 1.8	8L1	1.8	92	11.99 - 06.03	APG	4		BKUR6ET-10	2397	24	LPG 1
A 3 (1) 1.8 T	8L1	1.8	110	12.96 - 06.03	AGU	4	0,8	PFR6Q	6458	37	LPG 1
A 3 (1) 1.8 T	8L1	1.8	110	08.98 - 04.01	AQA	4	0,8	PFR6Q	6458	37	LPG 1
A 3 (1) 1.8 T	8L1	1.8	110	07.99 - 04.00	ARZ	4	0,8	PFR6Q	6458	37	LPG 1
A 3 (1) 1.8 T	8L1	1.8	110	09.00 - 06.03	ARX	4	0,8	PFR6Q	6458	37	LPG 1
A 3 (1) 1.8 T	8L1	1.8	110	05.00 - 06.03	AUM	4	0,8	PFR6Q	6458	37	LPG 1
A 3 (1) 1.8 T	8L1	1.8	132	11.98 - 08.00	AJQ	4	0,8	PFR6Q	6458	37	LPG 1
A 3 (1) 1.8 T	8L1	1.8	132	07.99 - 05.00	APP	4	0,8	PFR6Q	6458	37	LPG 1
A 3 (1) 1.8 T	8L1	1.8	132	09.00 - 06.03	ARY	4	0,8	PFR6Q	6458	37	LPG 1
A 3 (1) 1.8 T	8L1	1.8	132	05.00 - 06.03	AUQ	4	0,8	PFR6Q	6458	37	LPG 1
A 3 (1) 1.9 TDI	8L1	1.9	66	09.96 - 08.00	AGR	4	☑	Y-732J	5605	4	

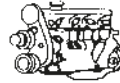
Code *l* kW

Cyl.

Stock-No.  
**V6**  
E-POWER

LPG/CNG

**AUDI****A 3 1**

A 3 (1) 1.9 TDI	8L1	1.9	66	08.97 - 06.01	ALH	4	▣	Y-732J	5605	4	
A 3 (1) 1.9 TDI	8L1	1.9	81	01.97 - 04.02	AHF	4	▣	Y-732J	5605	4	
A 3 (1) 1.9 TDI	8L1	1.9	81	09.99 - 06.01	ASV	4	▣	Y-732J	5605	4	
A 3 (1) 1.9 TDI Fgst → 8L-2-037-877	8L1	1.9	74	01.01 - 06.03	ATD	4	▣	Y-732J	5605	4	
A 3 (1) 1.9 TDI Fgst → 8L-2-037-877	8L1	1.9	74	11.01 - 06.03	AXR	4	▣	Y-732J	5605	4	
A 3 (1) 1.9 TDI Fgst → 8L-2-037-877	8L1	1.9	96	05.00 - 06.03	ASZ	4	▣	Y-732J	5605	4	
A 3 (1) 1.9 TDI Fgst 8L-2-037-878 →	8L1	1.9	74	01.01 - 06.03	ATD	4	▣	Y-741U	6943	20	
A 3 (1) 1.9 TDI Fgst 8L-2-037-878 →	8L1	1.9	74	11.01 - 06.03	AXR	4	▣	Y-741U	6943	20	
A 3 (1) 1.9 TDI Fgst 8L-2-037-878 →	8L1	1.9	96	05.00 - 06.03	ASZ	4	▣	Y-741U	6943	20	
A 3 (1) S 3	8L1	1.8	154	11.98 - 08.00	APY	4	0,8	PFR6Q	6458	37	LPG 1
A 3 (1) S 3	8L1	1.8	154	09.99 - 04.01	AUL	4	0,8	PFR6Q	6458	37	LPG 1
A 3 (1) S 3	8L1	1.8	154	09.00 - 04.02	AMK	4	0,8	PFR6Q	6458	37	LPG 1
A 3 (1) S 3	8L1	1.8	165	08.01 - 06.03	BAM	4	0,8	PFR6Q	6458	37	LPG 1

**A 3 2**

A 3 (2) 1.2 TFSI	8P1	1.2	77	03.10 -	CBZB	4	0,7	IZFR6P7	97153		IZFR6P7
A 3 (2) 1.4 TFSI	8P1	1.4	92	09.07 -	CAXC	4	0,9	PZFR6R	5758		PZFR6R
A 3 (2) 1.4 TFSI	8P1	1.4	92	05.10 -	CMSA	4	0,9	PZFR6R	5758		PZFR6R
A 3 (2) 1.6	8P1	1.6	75	05.03 - 05.05	BGU	4		BKUR6ET-10	2397	24	LPG 1
A 3 (2) 1.6	8P1	1.6	75	06.05 -	BSE	4		BKUR6ET-10	2397	24	LPG 1
A 3 (2) 1.6	8P1	1.6	75	06.05 -	BSF	4		BKUR6ET-10	2397	24	LPG 1
A 3 (2) 1.6	8P1	1.6	75	07.08 -	CCSA	4		BKUR6ET-10	2397	24	LPG 1
A 3 (2) 1.6	8P1	1.6	75	05.10 -	CMXA	4		BKUR6ET-10	2397	24	LPG 1
A 3 (2) 1.6 FSI	8P1	1.6	85	08.03 - 05.04	BAG	4		ZFR6S-Q	6449		ZFR6S-Q
A 3 (2) 1.6 FSI	8P1	1.6	85	06.04 - 12.04	BLP	4		ZFR6S-Q	6449		ZFR6S-Q
A 3 (2) 1.6 FSI	8P1	1.6	85	01.05 - 05.07	BLF	4		ZFR6S-Q	6449		ZFR6S-Q
A 3 (2) 1.6 TDI	8P1	1.6	66	05.09 -	CAYB	4	▣	Y1002AS	8888	57	
A 3 (2) 1.6 TDI	8P1	1.6	77	05.09 -	CAYC	4	▣	Y1002AS	8888	57	
A 3 (2) 1.8 TFSI	8P1	1.8	118	01.07 - 05.07	BYT	4	0,8	PFR7S8EG	1675		PFR8S8EG
A 3 (2) 1.8 TFSI	8P1	1.8	118	06.07 - 05.08	BZB	4	0,8	PFR7S8EG	1675		PFR8S8EG
A 3 (2) 1.8 TFSI	8P1	1.8	118	07.08 -	CDAA	4	0,8	PFR7S8EG	1675		PFR8S8EG
A 3 (2) 1.9 TDI	8P1	1.9	77	06.03 - 05.06	BKC	4	▣	Y-607AS	7560	50	
A 3 (2) 1.9 TDI	8P1	1.9	77	10.05 - 05.07	BLS	4	▣	Y-607AS	7560	50	
A 3 (2) 1.9 TDI	8P1	1.9	77	06.06 -	BXE	4	▣	Y-607AS	7560	50	
A 3 (2) 2.0 FSI	8P1	2.0	110	05.03 - 05.04	AXW	4		PZFR5N-11T	7742		PZFR5N-11T
A 3 (2) 2.0 FSI	8P1	2.0	110	06.04 - 01.05	BLX	4		PZFR5N-11T	7742		PZFR5N-11T
A 3 (2) 2.0 FSI	8P1	2.0	110	06.04 - 11.05	BLY	4	0,9	BKR6E	6962	28	LPG 1
A 3 (2) 2.0 FSI	8P1	2.0	110	01.04 - 01.05	BMB	4	0,9	BKR6E	6962	28	LPG 1
A 3 (2) 2.0 FSI	8P1	2.0	110	01.05 - 11.05	BLR	4		PZFR5N-11T	7742		PZFR5N-11T
A 3 (2) 2.0 FSI	8P1	2.0	110	11.05 - 01.07	BVY	4		PZFR5N-11T	7742		PZFR5N-11T
A 3 (2) 2.0 FSI	8P1	2.0	110	11.05 -	BVZ	4	0,9	BKR6E	6962	28	LPG 1
A 3 (2) 2.0 TDI	8P1	2.0	100	05.03 - 05.07	AZV	4	▣	YE14	7768	48	
A 3 (2) 2.0 TDI	8P1	2.0	100	04.08 - 05.10	CBAA	4	▣	Y-609AS	5849	49	
A 3 (2) 2.0 TDI	8P1	2.0	100	11.09 -	CFFA	4	▣	Y1002AS	8888	57	
A 3 (2) 2.0 TDI	8P1	2.0	103	05.03 - 05.07	BKD	4	▣	YE14	7768	48	
A 3 (2) 2.0 TDI	8P1	2.0	103	06.05 - 05.07	BMM	4	▣	CZ104	9826	52	
A 3 (2) 2.0 TDI	8P1	2.0	103	04.08 - 05.10	CBAB	4	▣	Y-609AS	5849	49	
A 3 (2) 2.0 TDI	8P1	2.0	103	11.09 -	CFFB	4	▣	Y1002AS	8888	57	
A 3 (2) 2.0 TDI	8P1	2.0	103	02.10 -	CLJA	4	▣	Y1002AS	8888	57	
A 3 (2) 2.0 TDI	8P1	2.0	120	06.06 - 05.07	BUY	4	▣	CZ304	9864	55	
A 3 (2) 2.0 TDI	8P1	2.0	125	03.06 -	BMN	4	▣	CZ304	9864	55	
A 3 (2) 2.0 TDI	8P1	2.0	125	07.08 - 05.10	CBBB	4	▣	Y-609AS	5849	49	

Fgst = Chassis No.

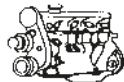
Code *ℓ* kW

Cyl.



Stock-No.

V-

LPG/CNG

**AUDI****A 3 2**

A 3 (2) 2.0 TDI	8P1	2.0	125	05.10 -	CFGB	4		Y1002AS	8888	57	
A 3 (2) 2.0 TFSI	8P1	2.0	147	09.04 - 10.05	AXX	4	0,8	PFR7S8EG	1675		PFR8S8EG
A 3 (2) 2.0 TFSI	8P1	2.0	147	09.05 -	BWA	4	0,8	PFR7S8EG	1675		PFR8S8EG
A 3 (2) 2.0 TFSI	8P1	2.0	147	07.08 -	CBFA	4	0,8	PFR7S8EG	1675		PFR8S8EG
A 3 (2) 2.0 TFSI	8P1	2.0	147	07.08 -	CCZA	4	0,8	PFR7S8EG	1675		PFR8S8EG
A 3 (2) 2.0 TFSI	8P1	2.0	147	02.08 - 01.09	CAWB	4	0,8	PFR7S8EG	1675		PFR8S8EG
A 3 (2) 3.2 quattro	8P1	3.2	184	07.03 - 08.04	BDB	6	0,9	IZKR7B	7563		IZKR7B
A 3 (2) 3.2 quattro	8P1	3.2	184	09.04 - 10.05	BMJ	6	0,9	IZKR7B	7563		IZKR7B
A 3 (2) 3.2 quattro	8P1	3.2	184	11.05 -	BUB	6	0,9	IZKR7B	7563		IZKR7B
A 3 (2) S 3	8P1	2.0	188	02.07 -	BZC	4	0,8	PFR7S8EG	1675		PFR8S8EG
A 3 (2) S 3	8P1	2.0	188	07.08 -	CDLC	4	0,8	PFR7S8EG	1675		PFR8S8EG
A 3 (2) S 3	8P1	2.0	195	11.06 - 05.07	BHZ	4	0,8	PFR7S8EG	1675		PFR8S8EG
A 3 (2) S 3	8P1	2.0	195	07.08 -	CDLA	4	0,8	PFR7S8EG	1675		PFR8S8EG

**A 3 3**

A 3 (3) 1.6 TDI ohne Drucksensor	8V1/8VA	1.6	77	09.12 -	CLHA	4		Y1002AS	8888	57	
A 3 (3) 2.0 TDI ohne Drucksensor Euro V	8V1/8VA	2.0	81	01.13 -	CRFA	4		Y1002AS	8888	57	
A 3 (3) 2.0 TDI ohne Drucksensor	8V1/8VA	2.0	105	09.12 -	CRFC	4		Y1002AS	8888	57	
A 3 (3) 2.0 TDI ohne Drucksensor Euro V	8V1/8VA	2.0	110	04.12 -	CRBC	4		Y1002AS	8888	57	
A 3 (3) 2.0 TDI ohne Drucksensor Euro V	8V1/8VA	2.0	110	04.12 -	CRLB	4		Y1002AS	8888	57	
A 3 (3) 2.0 TDI ohne Drucksensor Euro V	8V1/8VA	2.0	135	12.12 -	CUPA	4		Y1002AS	8888	57	

**A 4 1**

A 4 (1) 1.6	8D2/8D5 B5	1.6	74	11.94 - 10.96	ADP	4		BKUR6ET-10	2397	24	LPG 1
A 4 (1) 1.6	8D2/8D5 B5	1.6	74	10.96 - 07.99	AHL	4		BKUR6ET-10	2397	24	LPG 1
A 4 (1) 1.6	8D2/8D5 B5	1.6	74	08.98 - 06.00	ANA	4		BKUR6ET-10	2397	24	LPG 1
A 4 (1) 1.6	8D2/8D5 B5	1.6	74	08.98 - 09.01	ARM	4		BKUR6ET-10	2397	24	LPG 1
A 4 (1) 1.6	8D2/8D5 B5	1.6	75	07.00 - 11.00	ALZ	4		BKUR6ET-10	2397	24	LPG 1
A 4 (1) 1.8	8D2/8D5 B5	1.8	85	07.95 - 12.98	AFY	4		BKUR6ET-10	2397	24	LPG 1
A 4 (1) 1.8	8D2/8D5 B5	1.8	92	11.94 - 04.99	ADR	4		BKUR6ET-10	2397	24	LPG 1
A 4 (1) 1.8	8D2/8D5 B5	1.8	92	07.98 - 09.01	ARG	4		BKUR6ET-10	2397	24	LPG 1
A 4 (1) 1.8	8D2/8D5 B5	1.8	92	02.99 - 09.01	APT	4		BKUR6ET-10	2397	24	LPG 1
A 4 (1) 1.8	8D2/8D5 B5	1.8	92	06.00 - 09.01	AVV	4		BKUR6ET-10	2397	24	LPG 1
A 4 (1) 1.8 T	8D2/8D5 B5	1.8	110	01.96 - 12.98	AEB	4	0,8	PFR6Q	6458	37	LPG 1
A 4 (1) 1.8 T	8D2/8D5 B5	1.8	110	08.98 - 09.01	APU	4	0,8	PFR6Q	6458	37	LPG 1
A 4 (1) 1.8 T	8D2/8D5 B5	1.8	110	07.98 - 07.99	ARK	4	0,8	PFR6Q	6458	37	LPG 1
A 4 (1) 1.8 T	8D2/8D5 B5	1.8	110	05.99 - 06.00	ANB	4	0,8	PFR6Q	6458	37	LPG 1
A 4 (1) 1.8 T	8D2/8D5 B5	1.8	110	06.00 - 09.01	AWT	4	0,8	PFR6Q	6458	37	LPG 1
A 4 (1) 1.8 T	8D2/8D5 B5	1.8	132	08.97 - 09.01	AJL	4	0,8	PFR6Q	6458	37	LPG 1
A 4 (1) 1.8 T USA	8D2/8D5 B5	1.8	110	08.99 - 05.00	ATW	4	0,8	PFR6Q	6458	37	LPG 1
A 4 (1) 1.9 TDI	8D2/8D5 B5	1.9	55	03.96 - 06.00	AFF	4		Y-732J	5605	4	
A 4 (1) 1.9 TDI	8D2/8D5 B5	1.9	66	11.94 - 07.96	1Z	4		Y-732J	5605	4	
A 4 (1) 1.9 TDI	8D2/8D5 B5	1.9	66	08.96 - 06.00	AHU	4		Y-732J	5605	4	
A 4 (1) 1.9 TDI	8D2/8D5 B5	1.9	66	04.97 - 09.01	AHH	4		Y-732J	5605	4	
A 4 (1) 1.9 TDI	8D2/8D5 B5	1.9	81	02.96 - 07.99	AFN	4		Y-732J	5605	4	
A 4 (1) 1.9 TDI	8D2/8D5 B5	1.9	81	08.99 - 06.00	AVG	4		Y-732J	5605	4	
A 4 (1) 1.9 TDI	8D2/8D5 B5	1.9	85	08.98 - 09.01	AJM	4		Y-732J	5605	4	
A 4 (1) 1.9 TDI	8D2/8D5 B5	1.9	85	01.00 - 09.01	ATJ	4		Y-732J	5605	4	
A 4 (1) 2.4 V6	8D2/8D5 B5	2.4	120	08.97 - 07.98	AJG	6		BKR6EKUB	3584		LPG 1
A 4 (1) 2.4 V6	8D2/8D5 B5	2.4	120	08.97 - 11.00	AMM	6		BKR6EKUB	3584		LPG 1
A 4 (1) 2.4 V6	8D2/8D5 B5	2.4	120	08.98 - 06.00	APZ	6		BKR6EKUB	3584		LPG 1
A 4 (1) 2.4 V6	8D2/8D5 B5	2.4	121	08.97 - 07.98	AGA	6		BKR6EKUB	3584		LPG 1



Code *l* kW

Cyl.

Stock-No.  
**V-TIME**  
BY-PROMOTER

LPG/CNG

**AUDI****A 4 1**

A 4 (1) 2.4 V6	8D2/8D5 B5	2.4	121	08.97 - 07.98	ALF	6		BKR6EKUB	3584		LPG 1
A 4 (1) 2.4 V6	8D2/8D5 B5	2.4	121	08.98 - 09.01	AML	6		BKR6EKUB	3584		LPG 1
A 4 (1) 2.4 V6	8D2/8D5 B5	2.4	121	08.98 - 06.00	ARJ	6		BKR6EKUB	3584		LPG 1
A 4 (1) 2.4 V6 China	8D2/8D5 B5	2.4	110	07.95 - 07.97	AFM	6		BKUR6ET-10	2397	24	LPG 1
A 4 (1) 2.4 V6 China	8D2/8D5 B5	2.4	121	08.98 - 09.01	APS	6		BKR6EKUB	3584		LPG 1
A 4 (1) 2.5 V6 TDI	8D2/8D5 B5	2.5	110	11.97 - 06.00	AFB	6	☑	Y-501U	3786	31	
A 4 (1) 2.5 V6 TDI	8D2/8D5 B5	2.5	110	07.98 - 09.01	AKN	6	☑	Y-501U	3786	31	
A 4 (1) 2.6 V6	8D2/8D5 B5	2.6	110	11.94 - 07.97	ABC	6		BKUR6ET-10	2397	24	LPG 1
A 4 (1) 2.6 V6 China / GUS	8D2/8D5 B5	2.6	102	06.94 - 10.97	ACZ	6		BKUR6ET-10	2397	24	LPG 1
A 4 (1) 2.8 V6	8D2/8D5 B5	2.8	128	11.94 - 07.97	AAH	6		BKUR6ET-10	2397	24	LPG 1
A 4 (1) 2.8 V6	8D2/8D5 B5	2.8	142	03.96 - 07.98	ACK	6		BKR6EKUB	3584		LPG 1
A 4 (1) 2.8 V6	8D2/8D5 B5	2.8	142	05.97 - 07.98	ALG	6		BKR6EKUB	3584		LPG 1
A 4 (1) 2.8 V6	8D2/8D5 B5	2.8	142	07.98 - 09.01	AMX	6		BKR6EKUB	3584		LPG 1
A 4 (1) 2.8 V6	8D2/8D5 B5	2.8	142	08.98 - 06.00	APR	6		BKR6EKUB	3584		LPG 1
A 4 (1) 2.8 V6	8D2/8D5 B5	2.8	142	08.98 - 06.00	AQD	6		BKR6EKUB	3584		LPG 1
A 4 (1) 2.8 V6 China / USA	8D2/8D5 B5	2.8	140	03.99 - 09.01	ATX	6		BKR6EKUB	3584		LPG 1
A 4 (1) 2.8 V6 USA	8D2/8D5 B5	2.8	128	08.94 - 07.98	AFC	6		BKUR6ET-10	2397	24	LPG 1
A 4 (1) avant RS 4 quattro	8D2/8D5 B5	2.7	280	06.00 - 10.00	ASJ	6		PFR7Q	7963		PFR7Q
A 4 (1) avant RS 4 quattro	8D2/8D5 B5	2.7	280	11.00 - 09.01	AZR	6		PFR7Q	7963		PFR7Q
A 4 (1) S 4 quattro	8D2/8D5 B5	2.7	169	07.98 - 08.00	AJK	6	0,8	PFR6Q	6458	37	LPG 1
A 4 (1) S 4 quattro	8D2/8D5 B5	2.7	184	07.98 - 12.98	APB	6	0,8	PFR6Q	6458	37	LPG 1
A 4 (1) S 4 quattro	8D2/8D5 B5	2.7	195	10.97 - 09.01	AGB	6	0,8	PFR6Q	6458	37	LPG 1
A 4 (1) S 4 quattro	8D2/8D5 B5	2.7	195	11.00 - 09.01	AZB	6	0,8	PFR6Q	6458	37	LPG 1

**A 4 2**

A 4 (2) 1.6	8E2/8E5 B6	1.6	75	11.00 - 11.04	ALZ	4		BKUR6ET-10	2397	24	LPG 1
A 4 (2) 1.8 T	8E2/8E5 B6	1.8	110	12.00 - 06.02	AVJ	4	0,8	PFR6Q	6458	37	LPG 1
A 4 (2) 1.8 T	8E2/8E5 B6	1.8	120	07.02 - 11.04	BFB	4	0,8	PFR6Q	6458	37	LPG 1
A 4 (2) 1.8 T	8E2/8E5 B6	1.8	120	07.02 - 12.04	BKB	4	0,8	PFR6Q	6458	37	LPG 1
A 4 (2) 1.8 T	8E2/8E5 B6	1.8	140	11.02 - 12.04	BEX	4	0,8	PFR6Q	6458	37	LPG 1
A 4 (2) 1.9 TDI Fgst 8E-5-070251 →	8E2/8E5 B6	1.9	85	06.04 - 12.05	BKE	4	☑	Y-607AS	7560	50	
A 4 (2) 1.9 TDI Fgst → 8E-2-148-697	8E2/8E5 B6	1.9	74	04.01 - 05.04	AVB	4	☑	Y-732J	5605	4	
A 4 (2) 1.9 TDI Fgst → 8E-2-148-697	8E2/8E5 B6	1.9	96	11.00 - 12.04	AVF	4	☑	Y-732J	5605	4	
A 4 (2) 1.9 TDI Fgst → 8E-2-148-697	8E2/8E5 B6	1.9	96	12.00 - 06.03	AWX	4	☑	Y-732J	5605	4	
A 4 (2) 1.9 TDI Fgst 8E-2-148-698 →	8E2/8E5 B6	1.9	74	04.01 - 05.04	AVB	4	☑	Y-741U	6943	20	
A 4 (2) 1.9 TDI Fgst 8E-2-148-698 →	8E2/8E5 B6	1.9	96	11.00 - 12.04	AVF	4	☑	Y-741U	6943	20	
A 4 (2) 1.9 TDI Fgst 8E-2-148-698 →	8E2/8E5 B6	1.9	96	12.00 - 06.03	AWX	4	☑	Y-741U	6943	20	
A 4 (2) 2.0	8E2/8E5 B6	2.0	96	12.00 - 11.04	ALT	4		BKUR5ET-10	7553		LPG 1
A 4 (2) 2.0 FSI	8E2/8E5 B6	2.0	110	07.02 - 12.04	AWA	4		PZFR5N-11T	7742		PZFR5N-11T
A 4 (2) 2.4 V6	8E2/8E5 B6	2.4	120	09.01 - 12.04	AMM	6		BKR6EKUB	3584		LPG 1
A 4 (2) 2.4 V6	8E2/8E5 B6	2.4	125	09.01 - 12.04	BDV	6		BKR6EKUB	3584		LPG 1
A 4 (2) 2.5 V6 TDI	8E2/8E5 B6	2.5	114	04.01 - 06.02	AYM	6	☑	Y-501U	3786	31	
A 4 (2) 2.5 V6 TDI	8E2/8E5 B6	2.5	120	07.02 - 05.03	BFC	6	☑	Y-501U	3786	31	
A 4 (2) 2.5 V6 TDI	8E2/8E5 B6	2.5	120	06.03 - 12.05	BCZ	6	☑	Y-501U	3786	31	
A 4 (2) 2.5 V6 TDI	8E2/8E5 B6	2.5	120	06.03 - 10.04	BDG	6	☑	Y-501U	3786	31	
A 4 (2) 2.5 V6 TDI	8E2/8E5 B6	2.5	132	12.00 - 05.03	AKE	6	☑	Y-501U	3786	31	
A 4 (2) 2.5 V6 TDI	8E2/8E5 B6	2.5	132	06.03 - 12.04	BAU	6	☑	Y-501U	3786	31	
A 4 (2) 2.5 V6 TDI	8E2/8E5 B6	2.5	132	06.03 - 12.04	BDH	6	☑	Y-501U	3786	31	
A 4 (2) 3.0 V6	8E2/8E5 B6	3.0	160	04.01 - 10.04	BBJ	6		BKR6EKUB	3584		LPG 1
A 4 (2) 3.0 V6	8E2/8E5 B6	3.0	162	12.00 - 12.05	ASN	6		BKR6EKUB	3584		LPG 1
A 4 (2) 3.0 V6	8E2/8E5 B6	3.0	162	09.01 - 06.02	AVK	6	1,1	PFR6U-11G	5874		PFR6U-11G
A 4 (2) S 4 quattro	8E2/8E5 B6	4.2	253	03.03 - 10.04	BBK	8		BKR6EQUA	6872		LPG 1

Fgst = Chassis No.

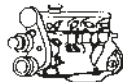
Code *ℓ* kW

Cyl.



Stock-No.



LPG/CNG

**AUDI****A 4 3**

A 4 (3) 1.6	8EC/8ED	1.6	75	11.04 -	ALZ	4		BKUR6ET-10	2397	24	LPG 1
A 4 (3) 1.8 T	8EC/8ED	1.8	120	11.04 -	BFB	4		PFR6Q	6458	37	LPG 1
A 4 (3) 1.9 TDI	8EC/8ED	1.9	85	11.05 -	BRB	4	☑	CZ104	9826	52	
A 4 (3) 2.0	8EC/8ED	2.0	96	11.04 -	ALT	4		BKUR5ET-10	7553		LPG 1
A 4 (3) 2.0 TDI	8EC/8ED	2.0	89	01.06 - 09.06	BVG	4	☑	CZ304	9864	55	
A 4 (3) 2.0 TDI	8EC/8ED	2.0	93	11.05 - 11.06	BVF	4	☑	CZ304	9864	55	
A 4 (3) 2.0 TDI	8EC/8ED	2.0	100	11.04 - 10.05	BNA	4	☑	YE14	7768	48	
A 4 (3) 2.0 TDI	8EC/8ED	2.0	100	11.05 -	BRF	4	☑	CZ304	9864	55	
A 4 (3) 2.0 TDI	8EC/8ED	2.0	103	11.04 - 11.05	BLB	4	☑	YE14	7768	48	
A 4 (3) 2.0 TDI	8EC/8ED	2.0	103	11.04 -	BPW	4	☑	CZ104	9826	52	
A 4 (3) 2.0 TDI	8EC/8ED	2.0	103	10.05 -	BRE	4	☑	CZ304	9864	55	
A 4 (3) 2.0 TDI	8EC/8ED	2.0	120	06.06 -	BVA	4	☑	CZ304	9864	55	
A 4 (3) 2.0 TDI	8EC/8ED	2.0	125	06.06 -	BRD	4	☑	CZ304	9864	55	
A 4 (3) 2.0 TFSI	8EC/8ED	2.0	125	10.06 -	BYK	4	0,8	PFR7S8EG	1675		PFR8S8EG
A 4 (3) 2.0 TFSI	8EC/8ED	2.0	125	03.07 -	BPJ	4	0,8	PFR7S8EG	1675		PFR8S8EG
A 4 (3) 2.0 TFSI	8EC/8ED	2.0	147	11.04 - 03.08	BGB	4	0,8	PFR7S8EG	1675		PFR8S8EG
A 4 (3) 2.0 TFSI	8EC/8ED	2.0	147	09.05 -	BWE	4	0,8	PFR7S8EG	1675		PFR8S8EG
A 4 (3) 2.0 TFSI	8EC/8ED	2.0	162	06.05 -	BUL	4	0,8	PFR7S8EG	1675		PFR8S8EG
A 4 (3) 2.5 V6 TDI	8EC/8ED	2.5	120	11.04 - 05.06	BDG	6	☑	Y-501U	3786	31	
A 4 (3) 2.7 V6 TDI	8EC/8ED	2.7	120	11.05 - 06.08	BSG	6	☑	Y-609AS	5849	49	
A 4 (3) 2.7 V6 TDI	8EC/8ED	2.7	132	01.06 - 03.09	BPP	6	☑	Y-609AS	5849	49	
A 4 (3) 3.0 V6	8EC/8ED	3.0	160	11.04 - 07.06	BBJ	6		BKR6EKUB	3584		LPG 1
A 4 (3) 3.0 V6 TDI	8EC/8ED	3.0	150	11.04 - 03.09	BKN	6	☑	Y-609AS	5849	49	
A 4 (3) 3.0 V6 TDI	8EC/8ED	3.0	171	01.06 - 03.09	ASB	6	☑	Y-609AS	5849	49	
A 4 (3) 3.2 FSI	8EC/8ED	3.2	188	01.05 -	AUK	6		PFR7W-T	6840		PFR7W-T
A 4 (3) RS 4 quattro	8EC/8ED	4.2	309	11.05 -	BNS	8		PFR7W-TG	5592		PFR7W-TG
A 4 (3) S 4 quattro	8EC/8ED	4.2	253	11.04 -	BBK	8		BKR6EQUA	6872		LPG 1
A 4 (3) S 4 quattro	8EC/8ED	4.2	253	03.06 -	BHF	8		BKR6EQUA	6872		LPG 1

**A 4 4**

A 4 (4) 1.8 TFSI	8K2/8K5	1.8	88	01.08 - 05.08	CABA	4	0,8	PFR7S8EG	1675		PFR8S8EG
A 4 (4) 1.8 TFSI	8K2/8K5	1.8	88	06.08 -	CDHA	4	0,8	PFR7S8EG	1675		PFR8S8EG
A 4 (4) 1.8 TFSI	8K2/8K5	1.8	118	11.07 - 05.08	CABB	4	0,8	PFR7S8EG	1675		PFR8S8EG
A 4 (4) 1.8 TFSI	8K2/8K5	1.8	118	06.08 -	CDHB	4	0,8	PFR7S8EG	1675		PFR8S8EG
A 4 (4) 2.0 TDI	8K2/8K5	2.0	88	06.08 -	CAGC	4	☑	Y-609AS	5849	49	
A 4 (4) 2.0 TDI	8K2/8K5	2.0	100	11.07 -	CAGB	4	☑	Y-609AS	5849	49	
A 4 (4) 2.0 TDI	8K2/8K5	2.0	100	11.10 -	CJCB	4	☑	Y1002AS	8888	57	
A 4 (4) 2.0 TDI	8K2/8K5	2.0	105	11.07 -	CAGA	4	☑	Y-609AS	5849	49	
A 4 (4) 2.0 TDI	8K2/8K5	2.0	105	05.10 -	CMEA	4	☑	Y1002AS	8888	57	
A 4 (4) 2.0 TDI	8K2/8K5	2.0	120	08.08 -	CAHB	4	☑	Y-609AS	5849	49	
A 4 (4) 2.0 TDI	8K2/8K5	2.0	125	08.08 -	CAHA	4	☑	Y-609AS	5849	49	
A 4 (4) 2.0 TDI	8K2/8K5	2.0	130	11.11 -	CGLC	4	☑	Y1002AS	8888	57	
A 4 (4) 2.0 TFSI	8K2/8K5	2.0	132	06.08 -	CAEA	4	0,8	PFR7S8EG	1675		PFR8S8EG
A 4 (4) 2.0 TFSI	8K2/8K5	2.0	132	06.08 -	CDNB	4	0,8	PFR7S8EG	1675		PFR8S8EG
A 4 (4) 2.0 TFSI	8K2/8K5	2.0	155	06.08 -	CDNC	4	0,8	PFR7S8EG	1675		PFR8S8EG
A 4 (4) 2.0 TFSI flexible fuel	8K2/8K5	2.0	132	11.09 -	CFKA	4	0,8	PFR7S8EG	1675		PFR8S8EG
A 4 (4) 2.7 V6 TDI	8K2/8K5	2.7	120	11.07 - 05.08	CAMB	6	☑	Y-609AS	5849	49	
A 4 (4) 2.7 V6 TDI	8K2/8K5	2.7	140	11.07 - 05.08	CAMA	6	☑	Y-609AS	5849	49	
A 4 (4) 3.0 V6 TDI	8K2/8K5	3.0	155	06.08 - 05.10	CCWB	6	☑	Y-609AS	5849	49	
A 4 (4) 3.0 V6 TDI	8K2/8K5	3.0	176	11.07 - 05.08	CAPA	6	☑	Y-609AS	5849	49	
A 4 (4) 3.0 V6 TDI	8K2/8K5	3.0	176	04.08 -	CCWA	6	☑	Y-609AS	5849	49	

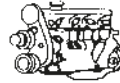
Code *l* kW

Cyl.

Stock-No.  
**V-TIME**  
BY-PROMOTER

LPG/CNG

**AUDI****A 4 4**

A 4 (4) 3.2 FSI	8K2/8K5	3.2	195	11.07 -	CALA	6	1,1	PFR6X-11	5757		PFR6X-11
A 4 (4) S 4 quattro	8K2/8K5	3.0	245	03.09 -	CAKA	6	0,8	PFR8S8EG	94460		PFR8S8EG
A 4 (4) S 4 quattro	8K2/8K5	3.0	245	03.09 -	CCBA	6	0,8	PFR8S8EG	94460		PFR8S8EG

**A 5**

A 5 1.8 TFSI	8T3/8F7/8TA	1.8	118	05.09 -	CDHB	4	0,8	PFR7S8EG	1675		PFR8S8EG
A 5 1.8 TFSI	8T3/8F7/8TA	1.8	125	10.07 - 11.08	CABD	4	0,8	PFR7S8EG	1675		PFR8S8EG
A 5 2.0 TDI	8T3/8TA	2.0	100	09.09 -	CAGB	4	█	Y-609AS	5849	49	
A 5 2.0 TDI	8T3/8TA	2.0	105	09.09 -	CAGA	4	█	Y-609AS	5849	49	
A 5 2.0 TDI	8T3/8TA	2.0	105	05.10 -	CMEA	4	█	Y1002AS	8888	57	
A 5 2.0 TDI	8T3/8F7/8TA	2.0	120	08.08 -	CAHB	4	█	Y-609AS	5849	49	
A 5 2.0 TDI	8T3/8F7/8TA	2.0	125	08.08 -	CAHA	4	█	Y-609AS	5849	49	
A 5 2.0 TDI	8T3/8F7/8TA	2.0	130	10.11 -	CGLC	4	█	Y1002AS	8888	57	
A 5 2.0 TFSI	8T3/8F7/8TA	2.0	132	09.08 -	CDNB	4	0,8	PFR7S8EG	1675		PFR8S8EG
A 5 2.0 TFSI	8T3/8F7/8TA	2.0	132	03.09 -	CAEA	4	0,8	PFR7S8EG	1675		PFR8S8EG
A 5 2.0 TFSI	8T3/8F7/8TA	2.0	155	06.08 -	CAEB	4	0,8	PFR7S8EG	1675		PFR8S8EG
A 5 2.0 TFSI	8T3/8F7/8TA	2.0	155	06.08 -	CDNC	4	0,8	PFR7S8EG	1675		PFR8S8EG
A 5 2.7 V6 TDI	8T3/8F7/8TA	2.7	120	09.07 - 05.08	CAMB	6	█	Y-609AS	5849	49	
A 5 2.7 V6 TDI	8T3/8F7/8TA	2.7	120	05.08 -	CGKB	6	█	Y-609AS	5849	49	
A 5 2.7 V6 TDI	8T3/8F7/8TA	2.7	140	07.07 - 05.08	CAMA	6	█	Y-609AS	5849	49	
A 5 2.7 V6 TDI	8T3/8F7/8TA	2.7	140	05.08 -	CGKA	6	█	Y-609AS	5849	49	
A 5 3.0 V6 TDI	8T3/8F7/8TA	3.0	155	03.08 - 05.10	CCWB	6	█	Y-609AS	5849	49	
A 5 3.0 V6 TDI	8T3/8F7/8TA	3.0	176	03.08 -	CCWA	6	█	Y-609AS	5849	49	
A 5 3.0 V6 TDI	8T3/8F7/8TA	3.0	177	06.07 - 05.08	CAPA	6	█	Y-609AS	5849	49	
A 5 3.2 FSI	8T3/8F7/8TA	3.2	195	06.07 -	CALA	6	1,1	PFR6X-11	5757		PFR6X-11
A 5 S 5 3.0 FSI quattro	8T3/8F7/8TA	3.0	245	05.09 -	CCBA	6	1,1	PFR6X-11	5757		PFR6X-11
A 5 S 5 4.2 FSI quattro	8T3	4.2	260	06.07 -	CAUA	8		PFR6W-TG	5547		
A 5 RS 5 4.2 FSI quattro	8T3	4.2	331	03.10 -	CFSA	8	0,8	PFR7S8EG	1675		PFR8S8EG

**A 6 1**

A 6 (1) 1.8	4A/C4	1.8	92	10.95 - 10.97	ADR	4		BKUR6ET-10	2397	24	LPG 1
A 6 (1) 1.9 TDI	4A/C4	1.9	66	07.94 - 06.96	1Z	4	█	Y-732J	5605	4	
A 6 (1) 1.9 TDI	4A/C4	1.9	66	07.96 - 10.97	AHU	4	█	Y-732J	5605	4	
A 6 (1) 2.0	4A/C4	2.0	74	06.94 - 06.96	AAE	4		BUR6ET	3172	1	LPG 2
A 6 (1) 2.0 16V	4A/C4	2.0	103	06.94 - 10.97	ACE	4		BKUR7ET	7873		PFR7Q
A 6 (1) 2.0 E	4A/C4	2.0	85	06.94 - 06.96	ABK	4		BUR6ET	3172	1	LPG 2
A 6 (1) 2.3 E	4A/C4	2.3	98	06.94 - 06.96	AAR	5		BPR5EKU	5685		LPG 2
A 6 (1) 2.5 TDI	4A/C4	2.5	85	06.94 - 10.97	AAT	5	█	Y-732J	5605	4	
A 6 (1) 2.5 TDI	4A/C4	2.5	103	10.94 - 10.97	AEL	5	█	Y-732J	5605	4	
A 6 (1) 2.6 E	4A/C4	2.6	110	06.94 - 10.97	ABC	6		BKUR6ET-10	2397	24	LPG 1
A 6 (1) 2.8 E	4A/C4	2.8	128	06.94 - 10.97	AAH	6		BKUR6ET-10	2397	24	LPG 1
A 6 (1) 2.8 E	4A/C4	2.8	128	08.94 - 06.95	AFC	6		BKUR6ET-10	2397	24	LPG 1
A 6 (1) 2.8 E	4A/C4	2.8	142	10.95 - 07.98	ACK	6		BKR6EKUB	3584		LPG 1
A 6 (1) 2.8 E GUS	4A/C4	2.8	120	07.96 - 10.97	AEJ	6	0,8	PFR5B	5341		PFR6B
A 6 (1) S 6	4A/C4	2.2	169	06.94 - 07.97	AAN	5	0,6	PFR7B	4853		PFR8B
A 6 (1) S 6 4.2	4A/C4	4.2	213	09.94 - 10.97	AEC	8	0,8	BUR6EFSZ	6837		
A 6 (1) S 6 Plus	4A/C4	4.2	240	06.96 - 10.97	AHK	8	0,8	BUR6EFSZ	6837		

**A 6 2**

A 6 (2) 1.8	4B/C5	1.8	92	12.97 - 07.99	AJP	4		BKUR6ET-10	2397	24	LPG 1
A 6 (2) 1.8	4B/C5	1.8	92	01.99 - 04.01	AQE	4		BKUR6ET-10	2397	24	LPG 1
A 6 (2) 1.8	4B/C5	1.8	92	01.99 - 04.01	ARH	4		BKUR6ET-10	2397	24	LPG 1
A 6 (2) 1.8 GUS	4B/C5	1.8	85	05.97 - 05.00	AFY	4		BKUR6ET-10	2397	24	LPG 1
A 6 (2) 1.8 T	4B/C5	1.8	110	04.97 - 01.99	AEB	4	0,8	PFR6Q	6458	37	LPG 1

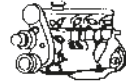
Code *ℓ* kW

Cyl.



Stock-No.



LPG/CNG

**AUDI  
A 6 2**

A 6 (2) 1.8 T	4B/C5	1.8	110	11.98 - 05.01	APU	4	0,8	PFR6Q	6458	37	LPG 1
A 6 (2) 1.8 T	4B/C5	1.8	110	01.99 - 05.01	ANB	4	0,8	PFR6Q	6458	37	LPG 1
A 6 (2) 1.8 T	4B/C5	1.8	110	01.99 - 05.99	ARK	4	0,8	PFR6Q	6458	37	LPG 1
A 6 (2) 1.8 T	4B/C5	1.8	110	05.00 - 01.05	AWT	4	0,8	PFR6Q	6458	37	LPG 1
A 6 (2) 1.8 T	4B/C5	1.8	132	11.97 - 10.00	AJL	4	0,8	PFR6Q	6458	37	LPG 1
A 6 (2) 1.9 TDI	4B/C5	1.9	81	04.97 - 04.01	AFN	4		Y-732J	5605	4	
A 6 (2) 1.9 TDI	4B/C5	1.9	81	08.99 - 10.00	AVG	4		Y-732J	5605	4	
A 6 (2) 1.9 TDI	4B/C5	1.9	85	11.00 - 04.01	AJM	4		Y-741U	6943	20	
A 6 (2) 1.9 TDI	4B/C5	1.9	96	06.01 - 01.05	AVF	4		Y-732J	5605	4	
A 6 (2) 1.9 TDI	4B/C5	1.9	96	06.01 - 01.05	AWX	4		Y-741U	6943	20	
A 6 (2) 2.0	4B/C5	2.0	96	06.01 - 01.05	ALT	4		BKUR5ET-10	7553		LPG 1
A 6 (2) 2.4	4B/C5	2.4	99	08.97 - 01.99	ALW	6		BKR6EKUB	3584		LPG 1
A 6 (2) 2.4	4B/C5	2.4	100	02.99 - 05.00	ARN	6		BKR6EKUB	3584		LPG 1
A 6 (2) 2.4	4B/C5	2.4	100	06.00 - 01.05	ASM	6		BKR6EKUB	3584		LPG 1
A 6 (2) 2.4	4B/C5	2.4	120	04.97 - 01.99	AJG	6		BKR6EKUB	3584		LPG 1
A 6 (2) 2.4	4B/C5	2.4	120	11.98 - 05.01	APZ	6		BKR6EKUB	3584		LPG 1
A 6 (2) 2.4	4B/C5	2.4	120	06.00 - 04.01	AMM	6		BKR6EKUB	3584		LPG 1
A 6 (2) 2.4	4B/C5	2.4	121	04.97 - 01.99	AGA	6		BKR6EKUB	3584		LPG 1
A 6 (2) 2.4	4B/C5	2.4	121	06.97 - 01.99	ALF	6		BKR6EKUB	3584		LPG 1
A 6 (2) 2.4	4B/C5	2.4	121	04.98 - 05.01	APC	6		BKR6EKUB	3584		LPG 1
A 6 (2) 2.4	4B/C5	2.4	121	11.98 - 05.01	ARJ	6		BKR6EKUB	3584		LPG 1
A 6 (2) 2.4	4B/C5	2.4	121	06.00 - 05.01	AML	6		BKR6EKUB	3584		LPG 1
A 6 (2) 2.4	4B/C5	2.4	125	06.01 - 01.05	BDV	6		BKR6EKUB	3584		LPG 1
A 6 (2) 2.4 China	4B/C5	2.4	121	11.98 - 05.01	APS	6		BKR6EKUB	3584		LPG 1
A 6 (2) 2.5 TDI	4B/C5	2.5	110	04.97 - 05.00	AFB	6		Y-501U	3786	31	
A 6 (2) 2.5 TDI	4B/C5	2.5	110	10.98 - 05.01	AKN	6		Y-501U	3786	31	
A 6 (2) 2.5 TDI	4B/C5	2.5	114	06.01 - 06.02	AYM	6		Y-501U	3786	31	
A 6 (2) 2.5 TDI	4B/C5	2.5	120	07.02 - 08.03	BFC	6		Y-501U	3786	31	
A 6 (2) 2.5 TDI	4B/C5	2.5	120	02.03 - 08.05	BCZ	6		Y-501U	3786	31	
A 6 (2) 2.5 TDI	4B/C5	2.5	120	02.03 - 01.05	BDG	6		Y-501U	3786	31	
A 6 (2) 2.5 TDI	4B/C5	2.5	132	11.99 - 08.03	AKE	6		Y-501U	3786	31	
A 6 (2) 2.5 TDI	4B/C5	2.5	132	02.03 - 08.05	BAU	6		Y-501U	3786	31	
A 6 (2) 2.5 TDI	4B/C5	2.5	132	02.03 - 01.05	BDH	6		Y-501U	3786	31	
A 6 (2) 2.7 T	4B/C5	2.7	169	02.99 - 08.00	AJK	6	0,8	PFR6Q	6458	37	LPG 1
A 6 (2) 2.7 T	4B/C5	2.7	169	09.00 - 05.01	AZA	6	0,8	PFR6Q	6458	37	LPG 1
A 6 (2) 2.7 T	4B/C5	2.7	184	05.00 - 06.02	ARE	6	0,8	PFR6Q	6458	37	LPG 1
A 6 (2) 2.7 T	4B/C5	2.7	184	07.02 - 08.05	BES	6	0,8	PFR6Q	6458	37	LPG 1
A 6 (2) 2.8	4B/C5	2.8	132	02.98 - 05.01	AGE	6		BKR6EKUB	3584		LPG 1
A 6 (2) 2.8	4B/C5	2.8	140	07.99 - 05.01	ATX	6		BKR6EKUB	3584		LPG 1
A 6 (2) 2.8	4B/C5	2.8	142	06.97 - 01.99	ALG	6		BKR6EKUB	3584		LPG 1
A 6 (2) 2.8	4B/C5	2.8	142	11.98 - 05.01	APR	6		BKR6EKUB	3584		LPG 1
A 6 (2) 2.8	4B/C5	2.8	142	11.98 - 05.01	AQD	6		BKR6EKUB	3584		LPG 1
A 6 (2) 2.8	4B/C5	2.8	142	06.00 - 05.01	AMX	6		BKR6EKUB	3584		LPG 1
A 6 (2) 2.8 USA	4B/C5	2.8	142	08.97 - 07.99	AHA	6		BKR6EKUB	3584		LPG 1
A 6 (2) 3.0	4B/C5	3.0	162	06.01 - 01.05	ASN	6		BKR6EKUB	3584		LPG 1
A 6 (2) 4.2 quattro	4B/C5	4.2	220	11.98 - 01.05	ARS	8		BKR6EQUA	6872		LPG 1
A 6 (2) 4.2 quattro	4B/C5	4.2	220	11.98 - 01.05	ASG	8		BKR6EQUA	6872		LPG 1
A 6 (2) 4.2 allroad	4B/C5	4.2	220	04.03 - 08.05	BAS	8		BKR6EQUA	6872		LPG 1
A 6 (2) RS 6 quattro	4B/C5	4.2	331	07.02 - 09.04	BCY	8		PFR7Q	7963		PFR7Q
A 6 (2) RS 6 plus quattro	4B/C5	4.2	353	04.04 - 01.05	BRV	8		PFR7Q	7963		PFR7Q



Code *l* kW

Cyl.

Stock-No.  
**VEINE**  
BY-PROMERZ

LPG/CNG

**AUDI****A 6 3**

A 6 (3) 2.0 TDI	4F2/4F5	2.0	89	09.05 - 06.06	BVG	4	█	CZ304	9864	55	
A 6 (3) 2.0 TDI	4F2/4F5	2.0	100	07.04 - 11.05	BNA	4	█	YE14	7768	48	
A 6 (3) 2.0 TDI	4F2/4F5	2.0	100	09.05 -	BRF	4	█	CZ304	9864	55	
A 6 (3) 2.0 TDI	4F2/4F5	2.0	100	10.08 -	CAGB	4	█	Y-609AS	5849	49	
A 6 (3) 2.0 TDI	4F2/4F5	2.0	103	07.04 - 11.05	BLB	4	█	YE14	7768	48	
A 6 (3) 2.0 TDI	4F2/4F5	2.0	103	09.05 - 10.08	BRE	4	█	CZ304	9864	55	
A 6 (3) 2.0 TDI	4F2/4F5	2.0	120	04.09 -	CAHB	4	█	Y-609AS	5849	49	
A 6 (3) 2.0 TDI	4F2/4F5	2.0	125	11.08 -	CAHA	4	█	Y-609AS	5849	49	
A 6 (3) 2.0 TFSI	4F2/4F5	2.0	125	06.05 -	BPJ	4	0,8	PFR7S8EG	1675		PFR8S8EG
A 6 (3) 2.4	4F2/4F5	2.4	130	04.04 - 10.08	BDW	6	1,1	PFR6X-11	5757		PFR6X-11
A 6 (3) 2.7 TDI	4F2/4F5	2.7	120	06.05 -	BSG	6	█	Y-609AS	5849	49	
A 6 (3) 2.7 TDI	4F2/4F5	2.7	120	10.08 -	CANB	6	█	Y-609AS	5849	49	
A 6 (3) 2.7 TDI	4F2/4F5	2.7	120	10.08 -	CAND	6	█	Y-609AS	5849	49	
A 6 (3) 2.7 TDI	4F2/4F5	2.7	132	11.04 - 10.08	BPP	6	█	Y-609AS	5849	49	
A 6 (3) 2.7 TDI	4F2/4F5	2.7	140	10.08 -	CANA	6	█	Y-609AS	5849	49	
A 6 (3) 2.7 TDI quattro	4F2/4F5	2.7	140	10.08 -	CANC	6	█	Y-609AS	5849	49	
A 6 (3) 2.8 FSI	4F2/4F5	2.8	140	10.08 -	CCDA	6	1,1	PFR6X-11	5757		PFR6X-11
A 6 (3) 2.8 FSI	4F2/4F5	2.8	154	11.06 -	BDX	6	1,1	PFR6X-11	5757		PFR6X-11
A 6 (3) 2.8 FSI	4F2/4F5	2.8	162	10.08 -	CCEA	6	1,1	PFR6X-11	5757		PFR6X-11
A 6 (3) 3.0 quattro	4F2/4F5	3.0	160	06.01 - 05.06	BBJ	6		BKR6EKUB	3584		LPG 1
A 6 (3) 3.0 TDI	4F2/4F5	3.0	155	03.05 - 10.08	BNG	6	█	Y-609AS	5849	49	
A 6 (3) 3.0 TDI	4F2/4F5	3.0	155	10.08 -	CDYB	6	█	Y-609AS	5849	49	
A 6 (3) 3.0 TDI quattro	4F2/4F5	3.0	165	04.04 - 05.06	BMK	6	█	Y-609AS	5849	49	
A 6 (3) 3.0 TDI quattro	4F2/4F5	3.0	171	05.06 - 10.08	ASB	6	█	Y-609AS	5849	49	
A 6 (3) 3.0 TDI quattro	4F2/4F5	3.0	176	10.08 -	CDYA	6	█	Y-609AS	5849	49	
A 6 (3) 3.0 TDI quattro	4F2/4F5	3.0	176	10.08 -	CDYC	6	█	Y-609AS	5849	49	
A 6 (3) 3.0 TFSI	4F2/4F5	3.0	213	10.08 -	CAJA	6	0,8	PFR8S8EG	94460		PFR8S8EG
A 6 (3) 3.0 TFSI quattro	4F2/4F5	3.0	220	10.08 -	CCAA	6	0,8	PFR8S8EG	94460		PFR8S8EG
A 6 (3) 3.2 FSI	4F2/4F5	3.2	188	04.04 -	AUK	6		PFR7W-T	6840		PFR7W-T
A 6 (3) 3.2 FSI	4F2/4F5	3.2	188	10.08 -	BKH	6	1,1	PFR6X-11	5757		PFR6X-11
A 6 (3) 4.2 FSI quattro	4F2/4F5	4.2	257	05.06 -	BVJ	8		PFR6W-TG	5547		
A 6 (3) 4.2 quattro	4F2/4F5	4.2	246	04.04 - 05.06	BAT	8		BKR6EQUA	6872		LPG 1
A 6 (3) S 6 quattro	4F2/4F5	5.2	320	06.06 -	BXA	10		PFR6W-TG	5547		

**A 6 4**

A 6 (4) 2.0 TDI	4G2/4G5	2.0	100	01.12 -	CGLE	4	█	Y1002AS	8888	57	
A 6 (4) 2.0 TDI	4G2/4G5	2.0	120	03.11 -	CGLD	4	█	Y1002AS	8888	57	
A 6 (4) 2.0 TDI	4G2/4G5	2.0	130	04.11 -	CGLC	4	█	Y1002AS	8888	57	
A 6 (4) 2.0 TDI	4G2/4G5	2.0	130	04.11 -	CMGB	4	█	Y1002AS	8888	57	
A 6 (4) 2.0 TFSI	4G2/4G5	2.0	132	05.11 -	CDNB	4	0,8	PFR7S8EG	1675		PFR8S8EG
A 6 (4) 2.0 TFSI	4G2/4G5	2.0	155	03.11 -	CAEB	4	0,8	PFR7S8EG	1675		PFR8S8EG
A 6 (4) 2.0 TFSI Hybrid	4G2/4G5	2.0	155	11.11 -	CHJA	4	0,8	PFR7S8EG	1675		PFR8S8EG
A 6 (4) 3.0 TFSI quattro	4G2/4G5	3.0	220	04.11 -	CGWB	6	0,8	PFR8S8EG	94460		PFR8S8EG
A 6 (4) 3.0 TFSI quattro	4G2/4G5	3.0	228	03.11 -	CGWD	6	0,8	PFR8S8EG	94460		PFR8S8EG
A 6 (4) 3.0 TFSI quattro	4G2/4G5	3.0	228	03.11 -	CGXB	6	0,8	PFR8S8EG	94460		PFR8S8EG
A 6 (4) 3.0 TFSI quattro	4G2/4G5	3.0	228	03.11 -	CTUA	6	0,8	PFR8S8EG	94460		PFR8S8EG
A 6 (4) 3.0 V6 TDI	4G2/4G5	3.0	150	04.11 -	CLAA	6	█	Y1002AS	8888	57	
A 6 (4) 3.0 V6 TDI	4G2/4G5	3.0	150	04.11 -	CLAB	6	█	Y1002AS	8888	57	
A 6 (4) 3.0 V6 TDI	4G2/4G5	3.0	180	04.11 -	CDUC	6	█	Y1002AS	8888	57	
A 6 (4) 3.0 V6 TDI quattro	4G2/4G5	3.0	230	11.11 -	CGQB	6	█	Y1002AS	8888	57	

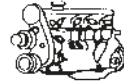
Code *l* kW

Cyl.

Stock-No.  
**VLINE**  
BY-PROFIT/2016

LPG/CNG

**AUDI****A 7**

A 7 3.0 TDI Sportback	4GA	3.0	150	12.10 -	CLAA	6		Y1002AS	8888	57	
A 7 3.0 TDI Sportback	4GA	3.0	150	11.10 -	CLAB	6		Y1002AS	8888	57	
A 7 3.0 TDI Sportback	4GA	3.0	180	07.10 -	CDUC	6		Y1002AS	8888	57	
A 7 3.0 TFSI Sportback	4GA	3.0	220	07.10 -	CGWB	6	0,8	PFR8S8EG	94460		PFR8S8EG
A 7 3.0 TFSI Sportback	4GA	3.0	228	05.11 -	CGXB	6	0,8	PFR8S8EG	94460		PFR8S8EG
A 7 3.0 TDI Sportback	4GA	3.0	230	11.11 -	CGQB	6		Y1002AS	8888	57	

**A 8 1**

A 8 (1) 2.5 TDI	4D2	2.5	110	06.97 - 04.00	AFB	6		Y-501U	3786	31	
A 8 (1) 2.5 TDI	4D2	2.5	110	11.97 - 09.02	AKN	6		Y-501U	3786	31	
A 8 (1) 2.5 TDI	4D2	2.5	132	11.99 - 09.02	AKE	6		Y-501U	3786	31	
A 8 (1) 2.8	4D2	2.8	120	07.95 - 03.96	AEJ	6	0,8	PFR5B	5341		PFR6B
A 8 (1) 2.8	4D2	2.8	128	06.94 - 03.96	AAH	6		BKR6ET-10	2397	24	LPG 1
A 8 (1) 2.8	4D2	2.8	142	04.96 - 09.98	ACK	6		BKR6EKUB	3584		LPG 1
A 8 (1) 2.8	4D2	2.8	142	01.99 - 02.01	APR	6		BKR6EKUB	3584		LPG 1
A 8 (1) 2.8	4D2	2.8	142	01.99 - 02.01	AQD	6		BKR6EKUB	3584		LPG 1
A 8 (1) 2.8	4D2	2.8	142	05.00 - 09.02	AMX	6		BKR6EKUB	3584		LPG 1
A 8 (1) 2.8	4D2	2.8	142	10.97 - 12.98	ALG	6		BKR6EKUB	3584		LPG 1
A 8 (1) 3.3 TDI	4D2	3.3	165	12.99 - 09.02	AKF	8		Y-501U	3786	31	
A 8 (1) 3.7	4D2	3.7	169	07.95 - 12.98	AEW	8	0,8	BUR6EFSZ	6837		
A 8 (1) 3.7	4D2	3.7	169	05.97 - 12.98	AKJ	8	0,8	BUR6EFSZ	6837		
A 8 (1) 4.2 quattro	4D2	4.2	180	06.94 - 07.96	AEM	8	0,8	BUR6EFSZ	6837		
A 8 (1) 4.2 quattro	4D2	4.2	220	06.97 - 12.98	AKG	8	0,8	BUR6EFSZ	6837		
A 8 (1) 4.2 quattro	4D2	4.2	220	06.94 - 05.99	ABZ	8	0,8	BUR6EFSZ	6837		
A 8 (1) 6.0 W12 quattro	4D2	6.0	309	03.01 - 09.02	AZC	12	1,1	PZFR6J-11	3586		LPG 6
A 8 (1) S 8 4.2 quattro	4D2	4.2	250	09.96 - 12.98	AHC	8	0,8	BUR6EFSZ	6837		
A 8 (1) S 8 4.2 quattro	4D2	4.2	250	08.97 - 12.98	AKH	8	0,8	BUR6EFSZ	6837		

**A 8 2**

A 8 (2) 2.8 FSI	4E	2.8	154	09.07 - 07.10	BDX	6	1,1	PFR6X-11	5757		PFR6X-11
A 8 (2) 3.0	4E	3.0	160	07.03 - 05.06	BBJ	6		BKR6EKUB	3584		LPG 1
A 8 (2) 3.0	4E	3.0	162	07.03 - 05.05	ASN	6		BKR6EKUB	3584		LPG 1
A 8 (2) 3.0 TDI Fgst 4E-5-003 301 →	4E	3.0	155	11.03 - 07.10	BNG	6		Y-609AS	5849	49	
A 8 (2) 3.0 TDI Fgst 4E-5-003 301 →	4E	3.0	171	01.04 - 07.10	ASB	6		Y-609AS	5849	49	
A 8 (2) 3.2 FSI	4E	3.2	191	06.05 - 07.10	BPK	6		PFR7W-T	6840		PFR7W-T
A 8 (2) 3.7 quattro	4E	3.7	206	11.02 - 05.06	BFL	8		BKR6EQUA	6872		LPG 1
A 8 (2) 4.0 TDI quattro	4E	4.0	202	05.03 - 07.05	ASE	8		Y-501U	3786	31	
A 8 (2) 4.2 FSI quattro	4E	4.2	257	06.06 - 07.10	BVJ	8		PFR6W-TG	5547		
A 8 (2) 4.2 quattro	4E	4.2	246	11.02 - 05.06	BFM	8		BKR6EQUA	6872		LPG 1
A 8 (2) 4.2 TDI quattro	4E	4.2	235	01.05 - 06.05	BMC	8		Y-609AS	5849	49	
A 8 (2) 4.2 TDI quattro	4E	4.2	240	07.05 - 07.10	BVN	8		Y-609AS	5849	49	
A 8 (2) 6.0 W12 quattro	4E	6.0	331	02.04 - 07.10	BHT	12	1,1	PZFR6J-11	3586		LPG 6
A 8 (2) S 8 5.2 quattro	4E	5.2	331	06.06 - 07.10	BSM	10		PFR6W-TG	5547		

**A 8 3**

A 8 (3) 2.0 TFSI Hybrid	4H	2.0	155	02.12 -	CHJA	4	0,8	PFR7S8EG	1675		PFR8S8EG
A 8 (3) 3.0 TDI quattro	4H	3.0	184	07.10 -	CDTA	6		Y1002AS	8888	57	
A 8 (3) 3.0 TFSI quattro	4H	3.0	213	07.10 -	CGWA	6	0,8	PFR8S8EG	94460		PFR8S8EG
A 8 (3) 3.0 TFSI quattro	4H	3.0	213	07.10 -	CGXA	6	0,8	PFR8S8EG	94460		PFR8S8EG
A 8 (3) 3.0 TFSI quattro	4H	3.0	245	06.10 -	CMDA	6	0,8	PFR8S8EG	94460		PFR8S8EG
A 8 (3) 3.0 TFSI quattro	4H	3.0	245	05.11 -	CGXC	6	0,8	PFR8S8EG	94460		PFR8S8EG
A 8 (3) 4.2 FSI quattro	4H	4.2	273	11.09 -	CDRA	8		PFR6W-TG	5547		

Fgst = Chassis No.

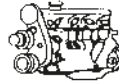
Code *l* kW

Cyl.



Stock-No.



LPG/CNG

**AUDI****A 8 3**

A 8 (3) 4.2 TDI quattro	4H	4.2	258	11.09 -	CDSB	8		Y-609AS	5849	49	
A 8 (3) 6.3 W12 quattro	4H	6.3	368	01.11 -	CEJA	12	0,8	ILZKR8A	94290		ILZKR8A

**CABRIO**

Cabrio 1.8		1.8	92	04.97 - 08.00	ADR	4		BKUR6ET-10	2397	24	LPG 1
Cabrio 1.9 TDI		1.9	66	07.95 - 07.96	1Z	4		Y-732J	5605	4	
Cabrio 1.9 TDI		1.9	66	07.96 - 08.00	AHU	4		Y-732J	5605	4	
Cabrio 2.0 E		2.0	85	01.93 - 09.98	ABK	4		BUR6ET	3172	1	LPG 2
Cabrio 2.0 E 16V		2.0	103	05.95 - 07.96	ACE	4		BKUR7ET	7873		PFR7Q
Cabrio 2,3 E		2.3	98	06.91 - 07.94	NG	5		BPR5EKU	5685		LPG 2
Cabrio 2.6 E		2.6	110	01.94 - 08.00	ABC	6		BKUR6ET-10	2397	24	LPG 1
Cabrio 2.6 E China / GUS		2.6	102	05.95 - 12.99	ACZ	6		BKUR6ET-10	2397	24	LPG 1
Cabrio 2.8 E		2.8	128	11.92 - 08.00	AAH	6		BKUR6ET-10	2397	24	LPG 1

**COUPÉ**

Coupé 2.0 E		2.0	85	08.90 - 07.91	AAD	4		BUR6ET	3172	1	LPG 2
Coupé 2.0 E		2.0	85	08.91 - 12.95	ABK	4		BUR6ET	3172	1	LPG 2
Coupé 2.0 E 16V		2.0	101	03.90 - 07.92	6A	4		BKUR7ET	7873		PFR7Q
Coupé 2.0 E 16V		2.0	103	08.92 - 12.95	ACE	4		BKUR7ET	7873		PFR7Q
Coupé 2.2 S2		2.2	162	09.90 - 09.92	3B	5	0,6	PFR7B	4853		PFR8B
Coupé 2.2 S2		2.2	169	10.92 - 12.95	ABY	5	0,6	PFR7B	4853		PFR8B
Coupé 2.6 E		2.6	110	08.92 - 12.95	ABC	6		BKUR6ET-10	2397	24	LPG 1
Coupé 2.8 E		2.8	128	08.91 - 12.95	AAH	6		BKUR6ET-10	2397	24	LPG 1

**Q 3**

Q 3 2.0 TDI	8UB	2.0	100	09.11 -	CFFA	4		Y1002AS	8888	57	
Q 3 2.0 TDI	8UB	2.0	103	09.11 -	CFFB	4		Y1002AS	8888	57	
Q 3 2.0 TDI	8UB	2.0	120	06.11 -	CFGD	4		Y1002AS	8888	57	
Q 3 2.0 TFSI	8UB	2.0	125	06.11 -	CCZC	4	0,8	PFR7S8EG	1675		PFR8S8EG
Q 3 2.0 TDI	8UB	2.0	130	06.11 -	CFGC	4		Y1002AS	8888	57	
Q 3 2.0 TDI	8UB	2.0	130	06.11 -	CLLB	4		Y1002AS	8888	57	
Q 3 2.0 TFSI	8UB	2.0	155	06.11 -	CPSA	4	0,8	PFR7S8EG	1675		PFR8S8EG

**Q 5**

Q 5 2.0 TDI	8R	2.0	100	08.09 -	CAGB	4		Y-609AS	5849	49	
Q 5 2.0 TDI	8R	2.0	100	05.10 -	CJCB	4		Y1002AS	8888	57	
Q 5 2.0 TDI	8R	2.0	105	08.09 -	CAGA	4		Y-609AS	5849	49	
Q 5 2.0 TDI	8R	2.0	105	05.10 -	CJCA	4		Y1002AS	8888	57	
Q 5 2.0 TDI	8R	2.0	120	11.08 - 09.10	CAHB	4		Y-609AS	5849	49	
Q 5 2.0 TDI	8R	2.0	120	05.10 -	CGLA	4		Y1002AS	8888	57	
Q 5 2.0 TDI	8R	2.0	125	11.08 - 09.10	CAHA	4		Y-609AS	5849	49	
Q 5 2.0 TDI	8R	2.0	125	05.10 -	CGLB	4		Y1002AS	8888	57	
Q 5 2.0 TDI	8R	2.0	125	11.10 -	CMGA	4		Y1002AS	8888	57	
Q 5 2.0 TDI	8R	2.0	130	07.12 -	CGLC	4		Y1002AS	8888	57	
Q 5 2.0 TDI	8R	2.0	130	07.12 -	CGMB	4		Y1002AS	8888	57	
Q 5 2.0 TFSI	8R	2.0	130	09.09 -	CDNA	4	0,8	PFR7S8EG	1675		PFR8S8EG
Q 5 2.0 TFSI	8R	2.0	132	08.09 -	CDNB	4	0,8	PFR7S8EG	1675		PFR8S8EG
Q 5 2.0 TFSI	8R	2.0	155	11.08 -	CDNC	4	0,8	PFR7S8EG	1675		PFR8S8EG
Q 5 2.0 TFSI	8R	2.0	155	05.10 -	CAEB	4	0,8	PFR7S8EG	1675		PFR8S8EG
Q 5 2.0 TFSI Hybrid	8R	2.0	155	06.11 -	CHJA	4	0,8	PFR7S8EG	1675		PFR8S8EG
Q 5 3.0 V6 TDI	8R	3.0	155	11.08 -	CCWB	6		Y-609AS	5849	49	
Q 5 3.0 V6 TDI	8R	3.0	176	11.08 -	CCWA	6		Y-609AS	5849	49	
Q 5 3.0 V6 TDI	8R	3.0	180	06.12 -	CDUD	6		Y1002AS	8888	57	

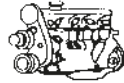
Code *l* kW

Cyl.



Stock-No.

LPG/CNG

**AUDI****Q 5**

Q 5 3.2 V6 FSI	8R	3.2	199	11.08 -	CALB	6	1,1	PFR6X-11	5757		PFR6X-11
----------------	----	-----	-----	---------	------	---	-----	----------	------	--	----------

**Q 7**

Q 7 3.0 TDI	4L	3.0	155	03.06 -	BUN	6		Y-609AS	5849	49	
Q 7 3.0 TDI	4L	3.0	155	11.07 - 05.10	CASB	6		Y-609AS	5849	49	
Q 7 3.0 TDI	4L	3.0	171	03.06 -	BUG	6		Y-609AS	5849	49	
Q 7 3.0 TDI	4L	3.0	176	11.07 - 05.10	CASA	6		Y-609AS	5849	49	
Q 7 3.0 TDI	4L	3.0	180	05.11 -	CJGD	6		Y1002AS	8888	57	
Q 7 3.0 TDI	4L	3.0	180	05.11 -	CRCA	6		Y1002AS	8888	57	
Q 7 3.0 TFSI	4L	3.0	200	05.10 -	CJTC	6	0,8	PFR8S8EG	94460		PFR8S8EG
Q 7 3.0 TFSI	4L	3.0	200	07.10 -	CJWC	6	0,8	PFR8S8EG	94460		PFR8S8EG
Q 7 3.0 TFSI	4L	3.0	245	05.10 -	CJTB	6	0,8	PFR8S8EG	94460		PFR8S8EG
Q 7 3.0 TFSI	4L	3.0	245	07.10 -	CJWB	6	0,8	PFR8S8EG	94460		PFR8S8EG
Q 7 3.0 TFSI	4L	3.0	245	07.10 -	CNA A	6	0,8	PFR8S8EG	94460		PFR8S8EG
Q 7 3.6 FSI	4L	3.6	206	08.06 -	BHK	6	0,9	ILZKR7A	1961		ILZKR7A
Q 7 4.2 FSI	4L	4.2	257	03.06 -	BAR	8		PFR6W-TG	5547		
Q 7 4.2 TDI	4L	4.2	230	03.07 -	BTR	8		Y-609AS	5849	49	
Q 7 4.2 TDI	4L	4.2	250	06.09 - 05.10	CCFA	8		Y-609AS	5849	49	
Q 7 6.0 TDI	4L	6.0	368	09.08 -	CCGA	12		Y-609AS	5849	49	

**R 8**

R 8 4.2		4.2	309	04.07 -	BYH	8		PFR7W-TG	5592		PFR7W-TG
R 8 5.2		5.2	386	04.09 - 09.10	BUJ	10		PFR7W-TG	5592		PFR7W-TG
R 8 5.2		5.2	386	09.10 -	BUJ	10	0,8	PFR7S8EG	1675		PFR8S8EG
R 8 5.2 GT		5.2	412	11.10 -	CMPA	10	0,8	PFR7S8EG	1675		PFR8S8EG

**TT 1**

TT (1) 1.8T	8N3/8N9	1.8	110	01.01 - 06.06	AUM	4	0,8	PFR6Q	6458	37	LPG 1
TT (1) 1.8T	8N3/8N9	1.8	120	09.05 - 06.06	BVP	4	0,8	PFR6Q	6458	37	LPG 1
TT (1) 1.8T	8N3/8N9	1.8	132	10.98 - 08.00	AJQ	4	0,8	PFR6Q	6458	37	LPG 1
TT (1) 1.8T	8N3/8N9	1.8	132	09.99 - 09.00	APP	4	0,8	PFR6Q	6458	37	LPG 1
TT (1) 1.8T	8N3/8N9	1.8	132	09.00 - 05.05	ARY	4	0,8	PFR6Q	6458	37	LPG 1
TT (1) 1.8T	8N3/8N9	1.8	132	09.00 - 06.06	AUQ	4	0,8	PFR6Q	6458	37	LPG 1
TT (1) 1.8T USA	8N3/8N9	1.8	132	09.00 - 06.06	AWP	4	0,8	PFR6Q	6458	37	LPG 1
TT (1) 1.8T USA	8N3/8N9	1.8	165	03.00 - 08.02	AMU	4	0,8	PFR6Q	6458	37	LPG 1
TT (1) 1.8T quattro	8N3/8N9	1.8	140	09.05 - 06.06	BVR	4	0,8	PFR6Q	6458	37	LPG 1
TT (1) 1.8T quattro	8N3/8N9	1.8	165	10.98 - 08.01	APX	4	0,8	PFR6Q	6458	37	LPG 1
TT (1) 1.8T quattro	8N3/8N9	1.8	165	09.00 - 05.05	BAM	4	0,8	PFR6Q	6458	37	LPG 1
TT (1) 1.8T quattro	8N3/8N9	1.8	180	03.05 - 05.05	BFV	4	0,8	PFR6Q	6458	37	LPG 1
TT (1) 3.2 V6 quattro	8N3/8N9	3.2	184	07.03 - 06.06	BHE	6	0,9	IZKR7B	7563		IZKR7B

**TT 2**

TT (2) 1.8TFSI	8J3/8J9	1.8	118	06.08 -	CDA A	4	0,8	PFR7S8EG	1675		PFR8S8EG
TT (2) 2.0 TDI quattro	8J3/8J9	2.0	125	06.08 -	CBBB	4		Y1002AS	8888	57	
TT (2) 2.0 TDI quattro	8J3/8J9	2.0	125	05.10 -	CFGB	4		Y1002AS	8888	57	
TT (2) 2.0 TDI quattro	8J3/8J9	2.0	125	06.08 - 06.10	CBBB	4		Y-609AS	5849	49	
TT (2) 2.0 TFSI	8J3/8J9	2.0	147	08.06 -	BWA	4	0,8	PFR7S8EG	1675		PFR8S8EG
TT (2) 2.0 TFSI	8J3/8J9	2.0	147	06.08 - 06.10	CCZA	4	0,8	PFR7S8EG	1675		PFR8S8EG
TT (2) 2.0 TFSI	8J3/8J9	2.0	155	05.10 -	CESA	4	0,8	PFR7S8EG	1675		PFR8S8EG
TT (2) 2.0 TFSI quattro	8J3/8J9	2.0	155	05.10 -	CETA	4	0,8	PFR7S8EG	1675		PFR8S8EG
TT (2) 2.0 TFSI quattro	8J3/8J9	2.0	195	05.08 -	CDLA	4	0,8	PFR7S8EG	1675		PFR8S8EG
TT (2) 2.0 TFSI quattro	8J3/8J9	2.0	195	05.10 -	CDMA	4	0,8	PFR7S8EG	1675		PFR8S8EG
TT (2) 2.0 TFSI quattro	8J3/8J9	2.0	200	05.08 -	CDLB	4	0,8	PFR7S8EG	1675		PFR8S8EG

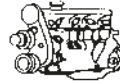

Code *l* kW

Cyl.



Stock-No.

LPG/CNG

**AUDI****TT 2**

TT (2) 2.5 TFSI RS	8J3/8J9	2.5	250	07.09 -	CEPA	5					
TT (2) 3.2 V6 quattro	8J3/8J9	3.2	184	08.06 -	BUB	6	0,9	IZKR7B	7563		IZKR7B

**V8**

V8 3.6		3.6	184	10.88 - 11.93	PT	8	0,8	BUR6EFSZ	6837		
V8 4.2		4.2	206	08.91 - 11.93	ABH	8	0,8	BUR6EFSZ	6837		

**AUSTIN**

Austin TAXI				08.83 -		4	<input checked="" type="checkbox"/>	Y-208T	1250		
Metro 310		1.0		09.89 - 04.92		4	0,7	BP6ES	7811	4	LPG 2
Metro 310		1.3		09.89 - 04.92		4	0,8	BPR6ES	7822	2	LPG 2

**AUTOBIANCHI**

Y10 Fire		1.0	32	10.87 - 09.92	156A2.100 Cat.	4	0,8	BCPR6ES	2330	12	LPG 3
Y10 i.e Igloo		1.1	37	03.94 - 10.96	156C046	4	0,8	BCPR6ES	2330	12	LPG 3
Y10 i.e Junior		1.1	37	03.94 - 10.96	156C046	4	0,8	BCPR6ES	2330	12	LPG 3
Y10 i.e Mia		1.1	37	01.94 - 10.96	156C046	4	0,8	BCPR6ES	2330	12	LPG 3
Y10 i.e 4WD		1.1	37	03.94 - 10.96	156C046	4	0,8	BCPR6ES	2330	12	LPG 3
Y10 i.e Selectronic		1.1	37	03.94 - 01.95	156C046	4	0,8	BCPR6ES	2330	12	LPG 3
Y10 i.e.		1.1	40	03.95 -		4	0,8	BCPR6ES	2330	12	LPG 3
Y10 Fire IE alle Modelle		1.1	41	01.89 - 10.96	156C000	4	0,8	BCPR6ES	2330	12	LPG 3
Y10 i.e GT/i.e GT Kat./Elite		1.3	53	11.87 - 09.92	156C5.046	4	0,8	BPR6ES	7822	2	LPG 2

**AVIA**

A21.1 D				10.90 -		4	<input checked="" type="checkbox"/>	Y-208T	1250		
---------	--	--	--	---------	--	---	-------------------------------------	--------	------	--	--

**AZLK (MOSKWITCZ)**

Aleko		1.8	70	12.86 - 12.00		4	0,8	BPR6ES	7822	2	LPG 2
Aleko		2.0	83	01.86 - 12.00	REN-F3R	4	0,9	BPR5ES	7422	6	LPG 2
Ish 2126		1.5		09.87 -		4	0,7	BP6ES	7811	4	LPG 2

**BEDFORD**

Brava Pickup 4x4		2.2		12.98 -			<input checked="" type="checkbox"/>	Y-306R	6244		
------------------	--	-----	--	---------	--	--	-------------------------------------	--------	------	--	--

**BENTLEY**

Arnage		4.4	210	04.98 - 08.98	BMW M62B44	8		BKR6EK	2288	20	LPG 1
Arnage		4.4	210	08.98 -	BMW M62B44	8		BKR6EQUP	3199	30	LPG 1
Arnage Green Label V8 Biturbo		4.4	260	08.99 - 12.01		8		BKR6EQUP	3199	30	LPG 1
Arnage		4.4		09.99 - 01	BMW	8		BKR6EQUP	3199	30	LPG 1
Arnage Red Label V8 6.8 turbo		6.8		09.99 -	RR	8		BKR5EVX	2546		LPG 1
Arnage Le Mans		6.8		03.01 -	RR	8	0.9	BKR4EVX	4870		
Azure		6.8		03.95 -		8		BKR5EVX	2546		LPG 1
Azure Mulliner		6.8		03.99 -		8		BKR5EVX	2546		LPG 1
Brooklands		6.8		09.92 - 09.99		8		BKR5EVX	2546		LPG 1
Continental R		6.8		12.91 -		8		BKR5EVX	2546		LPG 1

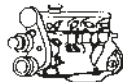
Code *ℓ* kW

Cyl.



Stock-No.

VLINE

10-15-20-25-30-35-40-45-50-55-60-65-70-75-80-85-90-95-100-105-110-115-120-125-130-135-140-145-150-155-160-165-170-175-180-185-190-195-200-205-210-215-220-225-230-235-240-245-250-255-260-265-270-275-280-285-290-295-300-305-310-315-320-325-330-335-340-345-350-355-360-365-370-375-380-385-390-395-400-405-410-415-420-425-430-435-440-445-450-455-460-465-470-475-480-485-490-495-500-505-510-515-520-525-530-535-540-545-550-555-560-565-570-575-580-585-590-595-600-605-610-615-620-625-630-635-640-645-650-655-660-665-670-675-680-685-690-695-700-705-710-715-720-725-730-735-740-745-750-755-760-765-770-775-780-785-790-795-800-805-810-815-820-825-830-835-840-845-850-855-860-865-870-875-880-885-890-895-900-905-910-915-920-925-930-935-940-945-950-955-960-965-970-975-980-985-990-995-1000

LPG/CNG

**BENTLEY**

Continental R		6.8		03.92 -	L4101T Cat.	8	1,0	BPR4EVX	3436		
Continental / Mulliner		6.8		02.97 -		8		BKR5EVX	2546		LPG 1
Continental R Mulliner		6.8		03.99 -		8		BKR5EVX	2546		LPG 1
Continental SC / Mulliner		6.8		03.99 - 09.00		8		BKR5EVX	2546		LPG 1
Continental R Le Mans		6.8		03.01 -		8		BKR5EVX	2546		LPG 1
Corniche 71—>02		6.8		07.93 - 08.95		8	0,9	BKR4EVX	4870		
Corniche 71—>02		6.8		09.95 -		8		BKR5EVX	2546		LPG 1
Eight		6.8		89 -	L4101 Cat.		1,0	BPR4EVX	3436		
Mulsanne / S / Eight		6.8		01.89 - 06.93		8	0,9	BPR4EVX	3436		
Mulsanne / S / Eight		6.8		07.93 -		8	0,9	BKR4EVX	4870		
Mulsanne S		6.8		89 -	L4101 Cat.		1,0	BPR4EVX	3436		
Turbo R 85—>96		6.8		01.89 - 09.96		8		BKR5EVX	2546		LPG 1
Turbo R		6.8		89 -	L4101T Cat.	8	1,0	BPR4EVX	3436		

**BERTONE**

Freeclimber 1.6i		1.6	74	02.92 -	M40 B16	4		BKR6EK	2288	20	LPG 1
Freeclimber 2.0i 4x4		2.0	95	01.91 -	M20 B20	6	0,8	ZGR5A	5839	15	
Freeclimber 2.7i 4x4		2.7	95	01.91 -	M20 B27	6	0,8	ZGR5A	5839	15	

**BMW  
1ER**

116i	E87	1.6	85	08.07 -	N45 B16	4		BKR6EQU	6002		LPG 1
116i	E81	1.6	90	08.07 -	N43 B16	4		ZKBR7A-HTU	91785		ZKBR7A-HTU
116i	E87	1.6	85	09.04 -	N45 B16	4		BKR6EQU	6002		LPG 1
116i	E87	1.6	90	08.07 -	N43 B16	4		ZKBR7A-HTU	91785		ZKBR7A-HTU
118 d	E87	2.0	90	09.04 -	M47 N204D4	4		Y-547AS	5968	47	
118 i	E81	2.0	95	04.07 -	N46 B20	4	1,1	IZFR6H11	4294		IZFR6H11
118 i	E81	2.0	105	05.07 -	N43 B20	4		ZKBR7A-HTU	91785		ZKBR7A-HTU
118 i	E87	2.0	95	09.04 -	N46 B20	4	1,1	IZFR6H11	4294		IZFR6H11
118 i	E87	2.0	105	05.07 -	N43 B20	4		ZKBR7A-HTU	91785		ZKBR7A-HTU
118 i Cabrio	E88	2.0	105	04.08 -	N43 B20	4		ZKBR7A-HTU	91785		ZKBR7A-HTU
120 i	E87	2.0	110	09.04 -	N46 B20	4	1,1	IZFR6H11	4294		IZFR6H11
120 d	E87	2.0	120	09.04 -	M47 N204D4	4		Y-547AS	5968	47	
120 i	E81	2.0	125	03.07 -	N43 B20	4		ZKBR7A-HTU	91785		ZKBR7A-HTU
120 i	E87	2.0	125	12.06 -	N43 B20	4		ZKBR7A-HTU	91785		ZKBR7A-HTU
120 i Cabrio	E88	2.0	125	04.08 -	N43 B20	4		ZKBR7A-HTU	91785		ZKBR7A-HTU
125 i Cabrio	E88	3.0	160	04.08 -	N52 B30	4	1,1	PLZFR6A11S	5987		
125 i Coupé	E82	3.0	160	09.07 -	N52 B30	6	1,1	PLZFR6A11S	5987		
130 i	E81	3.0	195	09.06 -	N52 B30	6	1,1	ILZFR6D11	1208		ILZFR6D11
130 i	E87	3.0	195	09.05 -	N52 B30	6	1,1	ILZFR6D11	1208		ILZFR6D11

**1ER F20**

114i	F20	1.6	75	11.11 -	N13B16A	4	0,8	PLZKBR7A-G	5843		PLZKBR7A-G
116i	F20	1.6	100	06.11 -	N13B16A	4	0,8	PLZKBR7A-G	5843		PLZKBR7A-G
118i	F20	1.6	125	06.11 -	N13B16A	4	0,8	PLZKBR7A-G	5843		PLZKBR7A-G

**3ER E36**

316 g Compact	E36	1.6	65	02.96 - 07.00	M43 B16	4		BKR6EK	2288	20	LPG 1
316 i	E36	1.6	73	05.91 - 08.93	M40 B16	4		BKR6EK	2288	20	LPG 1
316 i	E36	1.6	75	08.93 - 05.99	M43 B16	4		BKR6EK	2288	20	LPG 1
316 i Compact	E36	1.6	75	04.94 - 12.98	M43 B16	4		BKR6EK	2288	20	LPG 1
316 i Compact	E36	1.9	77	04.98 - 08.00	M43 B19	4		BKR6EK	2288	20	LPG 1

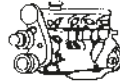
Code *l* kW

Cyl.



Stock-No.



LPG/CNG

**BMW****3ER E36**

318 Tds	E36	1.8	66	11.94 - 02.98	M41 D18	4	▣	Y-924J	7906	1	
318 i	E36	1.8	83	10.90 - 09.93	M40 B18	4		BKR6EK	2288	20	LPG 1
318 i	E36	1.8	85	08.93 - 09.99	M43 B18	4		BKR6EK	2288	20	LPG 1
318 i Touring	E36	1.8	85	09.94 - 09.99	M43 B18	4		BKR6EK	2288	20	LPG 1
318 iS	E36	1.8	103	10.91 - 03.96	M42 B18	4		BKR6EK	2288	20	LPG 1
318 ti Compact	E36	1.8	103	11.94 - 02.96	M42 B18	4		BKR6EK	2288	20	LPG 1
318 iS Coupe	E36	1.9	103	01.96 - 09.99	M44 B19	4		BKR6EK	2288	20	LPG 1
318 ti Compact	E36	1.9	103	02.95 - 12.98	M44 B19	4		BKR6EK	2288	20	LPG 1
320 i	E36	2.0	110	01.90 - 07.95	M50 B20	6		BKR6EK	2288	20	LPG 1
320 i	E36	2.0	110	09.94 - 09.99	M52 B20	6		BKR6EK	2288	20	LPG 1
320 i Touring	E36	2.0	110	04.94 - 05.99	M52 B20	6		BKR6EK	2288	20	LPG 1
323 i	E36	2.5	125	06.95 - 04.99	M52 B25	6		BKR6EK	2288	20	LPG 1
323 i Touring	E36	2.5	125	12.95 - 05.99	M52 B25	6		BKR6EK	2288	20	LPG 1
323 ti Compact	E36	2.5	125	10.97 - 12.98	M52 B25	6		BKR6EK	2288	20	LPG 1
325 i	E36	2.5	141	12.89 - 12.94	M50 B25	6		BKR6EK	2288	20	LPG 1
325 Td	E36	2.5	85	01.91 - 02.98	M51 D25	6	▣	Y-924J	7906	1	
325 Tds	E36	2.5	105	06.93 - 05.99	M51 D25	6	▣	Y-924J	7906	1	
328 i	E36	2.8	142	01.95 - 09.99	M52 B28	6		BKR6EK	2288	20	LPG 1
328 i Touring	E36	2.8	142	05.95 - 05.99	M52 B28	6		BKR6EK	2288	20	LPG 1
M3	E36	3.2	236	11.95 - 10.99	S50 B32	6	0,7	PKR7A	3641		PKR7A

**3ER E46**

316 Ci Coupé	E46	1.6	75	04.99 - 02.02	M43 B16	4		BKR6EQUP	3199	30	LPG 1
316 Ci Coupé	E46	1.8	85	03.02 - 02.04	N40 B18	4		BKR6EQUP	3199	30	LPG 1
316 Ci Coupé	E46	1.8	85	03.04 - 05.06	N45 B18	4	1,1	IZFR6H11	4294		IZFR6H11
316 i	E46	1.6	85	09.03 - 01.05	N45 B16	4	1,1	IZFR6H11	4294		IZFR6H11
316 i	E46	1.8	85	10.01 - 02.04	N42 B18	4		BKR6EQUP	3199	30	LPG 1
316 i	E46	1.8	85	09.03 - 01.05	N46 B18	4	1,1	IZFR6H11	4294		IZFR6H11
316 i	E46	1.9	77	01.99 - 09.01	M43 B19	4		BKR6EQUP	3199	30	LPG 1
316 i Touring	E46	1.8	85	10.01 - 02.04	N42 B18	4		BKR6EQUP	3199	30	LPG 1
316 i Touring	E46	1.8	85	10.03 - 07.05	N46 B18	4	1,1	IZFR6H11	4294		IZFR6H11
316 ti Compact	E46	1.8	85	05.01 - 02.04	N42 B18	4		BKR6EQUP	3199	30	LPG 1
316 ti Compact	E46	1.8	85	09.03 - 12.04	N46 B18	4	1,1	IZFR6H11	4294		IZFR6H11
318 Ci Cabrio	E46	2.0	105	12.00 - 03.05	N42 B20	4		BKR6EQUP	3199	30	LPG 1
318 Ci Cabrio	E46	2.0	110	04.05 - 08.06	N46 B20	4	1,1	IZFR6H11	4294		IZFR6H11
318 Ci Coupé	E46	1.9	87	09.99 - 08.01	M43 B19	4		BKR6EQUP	3199	30	LPG 1
318 Ci Coupé	E46	2.0	105	09.01 - 02.04	N42 B20	4		BKR6EQUP	3199	30	LPG 1
318 Ci Coupé	E46	2.0	110	10.03 - 05.06	N46 B20	4	1,1	IZFR6H11	4294		IZFR6H11
318 d	E46	2.0	85	09.01 - 11.03	M47 D20	4	▣	Y-507J	2691	32	
318 d	E46	2.0	85	08.02 - 01.05	M47 N D20	4	▣	Y-547AS	5968	47	
318 d Touring	E46	2.0	85	09.01 - 11.03	M47 D20	4	▣	Y-507J	2691	32	
318 d Touring	E46	2.0	85	08.02 - 07.05	M47 N D20	4	▣	Y-547AS	5968	47	
318 i	E46	1.9	87	04.98 - 08.01	M43 B19	4		BKR6EQUP	3199	30	LPG 1
318 i	E46	2.0	105	09.01 - 02.04	N42 B20	4		BKR6EQUP	3199	30	LPG 1
318 i	E46	2.0	105	10.03 - 02.05	N46 B20	4	1,1	IZFR6H11	4294		IZFR6H11
318 i Touring	E46	1.9	87	09.00 - 08.01	M43 B19	4		BKR6EQUP	3199	30	LPG 1
318 i Touring	E46	2.0	105	12.00 - 02.04	N42 B20	4		BKR6EQUP	3199	30	LPG 1
318 td Compact	E46	2.0	85	08.02 - 12.04	M47 N D20	4	▣	Y-547AS	5968	47	
318 ti Compact	E46	2.0	105	03.01 - 02.04	N42 B20	4		BKR6EQUP	3199	30	LPG 1
318 ti Compact	E46	2.0	105	09.03 - 12.04	N46 B20	4	1,1	IZFR6H11	4294		IZFR6H11
320 Cd	E46	2.0	110	03.03 - 05.06	M47 N D20	4	▣	Y-547AS	5968	47	

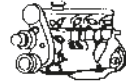
Code *l* kW

Cyl.



Stock-No.



LPG/CNG

**BMW  
3ER E46**

320 Cd Cabrio	E46	2.0	110	06.04 - 08.06	M47 N D20	4	☑	Y-547AS	5968	47	
320 Ci Cabrio	E46	2.2	125	02.00 - 08.06	M54 B22	6		BKR6EQU	3199	30	LPG 1
320 Ci Coupé	E46	2.2	125	01.00 - 03.03	M54 B22	6		BKR6EQU	3199	30	LPG 1
320 Ci Coupé	E46	2.0	110	11.98 - 08.01	M52 B20	6		BKR6EQU	3199	30	LPG 1
320 d	E46	2.0	100	07.97 - 08.01	M47 D20	4	☑	Y-507J	2691	32	
320 d	E46	2.0	110	10.00 - 01.05	M47 N D20	4	☑	Y-547AS	5968	47	
320 d Touring	E46	2.0	100	02.99 - 08.01	M47 D20	4	☑	Y-507J	2691	32	
320 d Touring	E46	2.0	110	06.99 - 07.05	M47 N D20	4	☑	Y-547AS	5968	47	
320 i	E46	2.2	125	06.00 - 01.05	M54 B22	6		BKR6EQU	3199	30	LPG 1
320 i	E46	2.0	110	07.97 - 07.01	M52 B20	6		BKR6EQU	3199	30	LPG 1
320 i Touring	E46	2.2	125	05.01 - 07.05	M54 B22	6		BKR6EQU	3199	30	LPG 1
320 i Touring	E46	2.0	110	05.98 - 08.01	M52 B20	6		BKR6EQU	3199	30	LPG 1
320 td Compact	E46	2.0	110	05.00 - 12.04	M47 N D20	4	☑	Y-547AS	5968	47	
323 Ci Cabrio	E46	2.5	125	11.98 - 09.00	M52 B25	6		BKR6EQU	3199	30	LPG 1
323 Ci Coupé	E46	2.5	125	03.98 - 08.00	M52 B25	6		BKR6EQU	3199	30	LPG 1
323 i	E46	2.5	125	07.97 - 10.00	M52 B25	6		BKR6EQU	3199	30	LPG 1
325 Ci Cabrio	E46	2.5	141	02.00 - 08.06	M54 B25	6		BKR6EQU	3199	30	LPG 1
325 Ci Coupé	E46	2.5	141	01.00 - 05.06	M54 B25	6		BKR6EQU	3199	30	LPG 1
325 i	E46	2.5	141	01.00 - 01.05	M54 B25	6		BKR6EQU	3199	30	LPG 1
325 i Touring	E46	2.5	141	02.00 - 07.05	M54 B25	6		BKR6EQU	3199	30	LPG 1
325 ti Compact	E46	2.5	141	03.00 - 12.04	M54 B25	6		BKR6EQU	3199	30	LPG 1
325 Xi	E46	2.5	141	01.00 - 12.04	M54 B25	6		BKR6EQU	3199	30	LPG 1
325 Xi Touring	E46	2.5	141	02.00 - 05.05	M54 B25	6		BKR6EQU	3199	30	LPG 1
328 Ci Coupé	E46	2.8	142	03.98 - 06.00	M52 B28	6		BKR6EQU	3199	30	LPG 1
328 i	E46	2.8	142	04.97 - 05.00	M52 B28	6		BKR6EQU	3199	30	LPG 1
328 i Touring	E46	2.8	142	05.98 - 06.00	M52 B28	6		BKR6EQU	3199	30	LPG 1
330 Cd Cabrio	E46	3.0	150	11.04 - 08.06	M57 N D30	6	☑	Y-547AS	5968	47	
330 Cd Coupé	E46	3.0	150	08.02 - 05.06	M57 N D30	6	☑	Y-547AS	5968	47	
330 Ci Cabrio	E46	3.0	170	12.99 - 08.06	M54 B30	6		BKR6EQU	3199	30	LPG 1
330 Ci Coupé	E46	3.0	170	09.99 - 05.06	M54 B30	6		BKR6EQU	3199	30	LPG 1
330 d	E46	3.0	135	09.00 - 11.03	M57 D30	6	☑	Y-507J	2691	32	
330 d	E46	3.0	150	03.03 - 02.05	M57 N D30	6	☑	Y-547AS	5968	47	
330 d Touring	E46	3.0	135	06.98 - 03.03	M57 D30	6	☑	Y-507J	2691	32	
330 d Touring	E46	3.0	150	09.02 - 07.05	M57 N D30	6	☑	Y-547AS	5968	47	
330 i	E46	3.0	170	09.99 - 01.05	M54 B30	6		BKR6EQU	3199	30	LPG 1
330 i Touring	E46	3.0	170	09.99 - 07.05	M54 B30	6		BKR6EQU	3199	30	LPG 1
330 Xd	E46	3.0	135	01.00 - 02.03	M57 D30	6	☑	Y-507J	2691	32	
330 Xd	E46	3.0	150	09.02 - 12.04	M57 N D30	6	☑	Y-547AS	5968	47	
330 Xd Touring	E46	3.0	150	08.02 - 05.05	M57 N D30	6	☑	Y-547AS	5968	47	
330 Xd Touring	E46	3.0	135	01.00 - 03.03	M57 D30	6	☑	Y-507J	2691	32	
330 Xi	E46	3.0	170	09.99 - 12.04	M54 B30	6		BKR6EQU	3199	30	LPG 1
330 Xi Touring	E46	3.0	170	09.99 - 05.05	M54 B30	6		BKR6EQU	3199	30	LPG 1
M3	E46	3.2	252	07.99 - 08.06	S54 B32	6		DCPR8EK	7415		
M3 CSL	E46	3.2	265	09.02 - 12.03	S54 B32	6		DCPR8EK	7415		

**3ER E90**

318 d	E90	2.0	90	09.05 - 09.07	M47 N204D4	4	☑	Y-547AS	5968	47	
318 i	E90	2.0	95	09.04 -	N46 B20	4	1,1	IZFR6H11	4294		IZFR6H11
318 i	E90	2.0	105	07.07 -	N43 B20	4		ZKBR7A-HTU	91785		ZKBR7A-HTU
320 d	E90	2.0	120	03.05 - 05.07	M47 N204D4	4	☑	Y-547AS	5968	47	
320 i	E90	2.0	110	03.05 -	N46 B20	4	1,1	IZFR6H11	4294		IZFR6H11



Code *l* kW

Cyl.



Stock-No.

V-TIME

LPG/CNG

**BMW****3ER E90**

320 i	E90	2.0	125	05.07 -	N43 B20	4		ZKBR7A-HTU	91785		ZKBR7A-HTU
325 d	E90	3.0	145	03.06 -	M57 N2 D30	6	▣	Y-547AS	5968	47	
325 i	E90	2.5	160	03.05 -	N52 B25	6	1,1	ILZFR6D11	1208		ILZFR6D11
325 i	E90	3.0	160	09.07 -	N53 B30	6		ZKBR7A-HTU	91785		ZKBR7A-HTU
330 d	E90	3.0	170	01.06 -	M57 N2 D30	6	▣	Y-547AS	5968	47	
330 i	E90	3.0	190	03.05 -	N52 B30	6	1,1	ILZFR6D11	1208		ILZFR6D11
330 i	E90	3.0	200	07.07 -	N53 B30	6		ZKBR7A-HTU	91785		ZKBR7A-HTU
335 d	E90	3.0	210	09.06 -	M57 N2 D30	6	▣	Y-547AS	5968	47	
M3	E90	4.0	309	09.07 -	S65 B40	8		LKR8AP	4471		LKR8AP

**3ER E91**

318 d Touring	E91	2.0	90	09.05 - 09.07	M47 N204D4	4	▣	Y-547AS	5968	47	
318 i Touring	E91	2.0	105	09.07 -	N43 B20	4		ZKBR7A-HTU	91785		ZKBR7A-HTU
318 i Touring	E91	2.0	95	03.06 -	N46 B20	4	1,1	IZFR6H11	4294		IZFR6H11
320 d Touring	E91	2.0	120	09.05 - 11.07	M47 N204D4	4	▣	Y-547AS	5968	47	
320 i Touring	E91	2.0	110	10.05 -	N46 B20	4	1,1	IZFR6H11	4294		IZFR6H11
320 i Touring	E91	2.0	125	09.07 -	N43 B20	4		ZKBR7A-HTU	91785		ZKBR7A-HTU
325 d Touring	E91	3.0	145	03.06 -	M57 N2 D30	6	▣	Y-547AS	5968	47	
325 i Touring	E91	2.5	160	09.05 -	N52 B25	6	1,1	ILZFR6D11	1208		ILZFR6D11
325 i Touring	E91	3.0	160	09.07 -	N53 B30	6		ZKBR7A-HTU	91785		ZKBR7A-HTU
330 d Touring	E91	3.0	170	09.05 -	M57 N2 D30	6	▣	Y-547AS	5968	47	
330 i Touring	E91	3.0	190	09.05 -	N52 B30	6	1,1	ILZFR6D11	1208		ILZFR6D11
330 i Touring	E91	3.0	200	09.07 -	N53 B30	6		ZKBR7A-HTU	91785		ZKBR7A-HTU
335 d Touring	E91	3.0	210	09.06 -	M57 N2 D30	6	▣	Y-547AS	5968	47	

**3ER E92**

316 i Coupé	E92	2.0	90	08.07 -	N43 B16	4		ZKBR7A-HTU	91785		ZKBR7A-HTU
320 i Coupé	E92	2.0	115	10.06 -	N46 B20	4	1,1	IZFR6H11	4294		IZFR6H11
320 i Coupé	E92	2.0	125	03.07 -	N43 B20	4		ZKBR7A-HTU	91785		ZKBR7A-HTU
325 d Coupé	E92	3.0	145	03.06 -	M57 N2 D30	6	▣	Y-547AS	5968	47	
325 i Coupé	E92	2.5	160	09.06 -	N52 B25	6	1,1	ILZFR6D11	1208		ILZFR6D11
325 i Coupé	E92	3.0	160	09.07 -	N53 B30	6		ZKBR7A-HTU	91785		ZKBR7A-HTU
330 Cd	E92	3.0	170	09.06 -	M57 N2 D30	6	▣	Y-547AS	5968	47	
330 i Coupé	E92	3.0	200	09.06 -	N52 B30	6	1,1	ILZFR6D11	1208		ILZFR6D11
330 i Coupé	E92	3.0	200	09.07 -	N53 B30	6		ZKBR7A-HTU	91785		ZKBR7A-HTU
335 d Coupé	E92	3.0	210	09.06 -	M57 N2 D30	6	▣	Y-547AS	5968	47	
M3	E92	4.0	309	03.07 -	S65 B40	8		LKR8AP	4471		LKR8AP

**3ER E93**

320 i Cabrio	E93	2.0	125	04.07 -	N46 B20	4	1,1	IZFR6H11	4294		IZFR6H11
325 i Cabrio	E93	2.5	160	04.07 -	N52 B25	6	1,1	ILZFR6D11	1208		ILZFR6D11
325 i Cabrio	E93	3.0	160	09.07 -	N53 B30	6		ZKBR7A-HTU	91785		ZKBR7A-HTU
330 d Cabrio	E93	3.0	170	04.07 -	M57 N2 D30	6	▣	Y-547AS	5968	47	
330 i Cabrio	E93	3.0	200	04.07 -	N52 B30	6	1,1	ILZFR6D11	1208		ILZFR6D11
330 i Cabrio	E93	3.0	200	09.07 -	N53 B30	6		ZKBR7A-HTU	91785		ZKBR7A-HTU
M3	E93	4.0	309	09.07 -	S65 B40	8		LKR8AP	4471		LKR8AP

**5ER E34**

518 g Touring	E34	1.8	75	11.95 - 06.96	M43 B18	4		BKR6EK	2288	20	LPG 1
518 i	E34	1.8	83	09.89 - 04.94	M40 B18	4		BKR6EK	2288	20	LPG 1
518 i	E34	1.8	85	05.94 - 06.96	M43 B18	4		BKR6EK	2288	20	LPG 1
520 i	E34	2.0	95	01.88 - 08.91	M20 B20	6	0,8	ZGR5A	5839	15	
520 i	E34	2.0	110	03.89 - 06.96	M50 B20	6		BKR6EK	2288	20	LPG 1
524 Td	E34	2.4	85	03.88 - 08.91	M21 D24	6	▣	Y-924J	7906	1	
525 Td	E34	2.5	85	06.92 - 06.96	M51 D25	6	▣	Y-924J	7906	1	

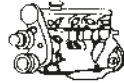
Code *l* kW

Cyl.

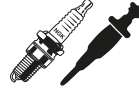
Stock-No.  
**VLIVE**  
BMW/FRONTIER

LPG/CNG

**BMW  
5ER E34**

525 Tds	E34	2.5	105	01.90 - 06.96	M51 D25	6		Y-924J	7906	1	
525 i	E34	2.5	125	01.88 - 08.91	M20 B25	6	0,8	ZGR5A	5839	15	
525 i	E34	2.5	141	01.89 - 06.96	M50 B25	6		BKR6EK	2288	20	LPG 1
525 iX	E34	2.5	141	01.92 - 09.95	M50 B25	6		BKR6EK	2288	20	LPG 1
530 i	E34	3.0	138	01.88 - 08.91	M30 B30	6	0,8	ZGR5A	5839	15	
530 i	E34	3.0	155	04.92 - 06.96	M60 B30	8		BKR6EK	2288	20	LPG 1
535 i	E34	3.5	155	01.88 - 08.92	M30 B35	6	0,8	ZGR5A	5839	15	
540 i	E34	4.0	210	03.92 - 06.96	M60 B40	8		BKR6EK	2288	20	LPG 1

**5ER E39**

520 d	E39	2.0	100	09.99 - 08.03	M47 D20	4		Y-507J	2691	32	
520 d Touring	E39	2.0	100	09.99 - 08.03	M47 D20	4		Y-507J	2691	32	
520 i	E39	2.0	110	01.96 - 08.98	M52 B20	6		BKR6EK	2288	20	LPG 1
520 i	E39	2.0	110	09.98 - 06.03	M52 B20	6		BKR6EQUP	3199	30	LPG 1
520 i Touring	E39	2.0	110	03.97 - 08.98	M52 B20	6		BKR6EK	2288	20	LPG 1
520 i Touring	E39	2.0	110	09.98 - 07.01	M52 B20	6		BKR6EQUP	3199	30	LPG 1
520 i	E39	2.2	125	08.00 - 09.03	M54 B22	6		BKR6EQUP	3199	30	LPG 1
520 i	E39	2.2	125	08.00 - 06.03	M54 B22	6		BKR6EQUP	3199	30	LPG 1
520 i Touring	E39	2.2	125	04.00 - 12.03	M54 B22	6		BKR6EQUP	3199	30	LPG 1
520 i Touring	E39	2.2	125	08.00 - 05.04	M54 B22	6		BKR6EQUP	3199	30	LPG 1
525 Tds	E39	2.5	105	03.95 - 10.00	M51 D25	6		Y-924J	7906	1	
525 d	E39	2.5	120	03.00 - 12.03	M57 D25	6		Y-507J	2691	32	
525 d Touring	E39	2.5	120	03.00 - 12.03	M57 D25	6		Y-507J	2691	32	
523 i	E39	2.5	125	12.95 - 08.98	M52 B25	6		BKR6EK	2288	20	LPG 1
523 i	E39	2.5	125	09.98 - 12.00	M52 B25	6		BKR6EQUP	3199	30	LPG 1
523 i Touring	E39	2.5	125	03.97 - 08.98	M52 B25	6		BKR6EK	2288	20	LPG 1
523 i Touring	E39	2.5	125	09.98 - 12.00	M52 B25	6		BKR6EQUP	3199	30	LPG 1
525 i	E39	2.5	141	11.99 - 11.03	M54 B25	6		BKR6EQUP	3199	30	LPG 1
525 i Touring	E39	2.5	141	04.00 - 12.03	M54 B25	6		BKR6EQUP	3199	30	LPG 1
528 i	E39	2.8	142	12.95 - 08.98	M52 B28	6		BKR6EK	2288	20	LPG 1
528 i	E39	2.8	142	09.98 - 11.00	M52 B28	6		BKR6EQUP	3199	30	LPG 1
528 i Touring	E39	2.8	142	03.97 - 08.98	M52 B28	6		BKR6EK	2288	20	LPG 1
528 i Touring	E39	2.8	142	09.98 - 12.00	M52 B28	6		BKR6EQUP	3199	30	LPG 1
530 d	E39	3.0	142	09.98 - 12.03	M57 D30	6		Y-507J	2691	32	
530 d Touring	E39	3.0	142	02.99 - 03.04	M57 D30	6		Y-507J	2691	32	
530 i	E39	3.0	170	04.00 - 06.03	M54 B30	6		BKR6EQUP	3199	30	LPG 1
530 i Touring	E39	3.0	170	11.99 - 12.03	M54 B30	6		BKR6EQUP	3199	30	LPG 1
535 i	E39	3.5	180	06.96 - 08.98	M62 B35	8		BKR6EK	2288	20	LPG 1
535 i	E39	3.5	180	09.98 - 09.03	M62 B35	8		BKR6EQUP	3199	30	LPG 1
540 i	E39	4.4	210	04.96 - 08.98	M62 B44	8		BKR6EK	2288	20	LPG 1
540 i	E39	4.4	210	09.98 - 11.03	M62 B44	8		BKR6EQUP	3199	30	LPG 1
540 i Touring	E39	4.4	210	03.97 - 08.98	M62 B44	8		BKR6EK	2288	20	LPG 1
540 i Touring	E39	4.4	210	09.98 - 12.03	M62 B44	8		BKR6EQUP	3199	30	LPG 1
M5	E39	5.0	294	09.98 - 07.03	S62 B50	8		BKR6EQUP	3199	30	LPG 1

**5ER E60**

520 d	E60	2.0	120	02.05 - 09.07	M47 N204D4	4		Y-547AS	5968	47	
520 i	E60	2.0	125	05.07 -	N43 B20	4		ZKBR7A-HTU	91785		ZKBR7A-HTU
520 i	E60	2.2	125	02.02 - 02.05	M54 B22	6		BKR6EQUP	3199	30	LPG 1
523 i	E60	2.5	130	07.04 - 11.06	N52 B25	6	1,1	ILZFR6D11	1208		ILZFR6D11
525 d	E60	2.5	130	03.04 - 11.06	M57 N D25	6		Y-547AS	5968	47	

Code *l* kW

Cyl.



Stock-No.

LPG/CNG

**BMW****5ER E60**

523 i	E60	2.5	140	02.07 -	N53 B25	6		ZKBR7A-HTU	91785		ZKBR7A-HTU
525 i	E60	2.5	141	09.03 - 12.04	M54 B25	6		BKR6EQUP	3199	30	LPG 1
525 d	E60	2.5	145	12.06 -	M57 N2 D25	6	☑	Y-547AS	5968	47	
525 i	E60	2.5	160	09.04 -	N52 B25	6	1,1	ILZFR6D11	1208		ILZFR6D11
525 i	E60	2.5	160	03.07 -	N53 B25	6		ZKBR7A-HTU	91785		ZKBR7A-HTU
530 d	E60	3.0	160	08.02 - 10.05	M57 N D30	6	☑	Y-547AS	5968	47	
530 Xd	E60	3.0	160	10.05 -	M57 N D30	6	☑	Y-547AS	5968	47	
530 d	E60	3.0	170	02.05 -	M57 N2 D30	6	☑	Y-547AS	5968	47	
530 i	E60	3.0	170	07.03 - 12.04	M54 B30	6		BKR6EQUP	3199	30	LPG 1
530 i	E60	3.0	190	10.04 -	N52 B30	6	1,1	ILZFR6D11	1208		ILZFR6D11
530 i	E60	3.0	200	01.07 -	N53 B30	6		ZKBR7A-HTU	91785		ZKBR7A-HTU
535 d	E60	3.0	200	09.04 - 02.05	M57 N D30	6	☑	Y-547AS	5968	47	
535 d	E60	3.0	210	09.05 -	M57 N2 D30	6	☑	Y-547AS	5968	47	
540 i	E60	4.0	225	10.05 -	N62 B40	8	1,1	IZFR6H11	4294		IZFR6H11
545 i	E60	4.4	245	09.03 - 10.05	N62 B44	8		BKR6EQUP	3199	30	LPG 1
550 i	E60	4.8	270	02.05 -	N62 B48	8	1,1	IZFR6H11	4294		IZFR6H11
M5	E60	5.0	373	11.04 -	S85 B50	10		LKR8AP	4471		LKR8AP

**5ER E61**

520 d Touring	E61	2.0	120	11.05 -	M47 N204D4	4	☑	Y-547AS	5968	47	
523 i Touring	E61	2.5	130	03.05 -	N52 B25	6	1,1	ILZFR6D11	1208		ILZFR6D11
525 d Touring	E61	2.5	130	05.04 -	M57 N D25	6	☑	Y-547AS	5968	47	
523 i Touring	E61	2.5	140	03.07 -	N53 B25	6		ZKBR7A-HTU	91785		ZKBR7A-HTU
525 i Touring	E61	2.5	141	05.04 - 12.04	M54 B25	6		BKR6EQUP	3199	30	LPG 1
525 i Touring	E61	2.5	160	09.04 -	N52 B25	6	1,1	ILZFR6D11	1208		ILZFR6D11
525 i Touring	E61	2.5	160	03.07 -	N53 B25	6		ZKBR7A-HTU	91785		ZKBR7A-HTU
530 d Touring	E61	3.0	160	11.02 - 10.05	M57 N D30	6	☑	Y-547AS	5968	47	
530 d Touring	E61	3.0	173	02.05 -	M57 N2 D30	6	☑	Y-547AS	5968	47	
530 d Touring	E61	3.0	180	02.10 -	M57 N2 D30	6	☑	Y-547AS	5968	47	
530 i Touring	E61	3.0	190	10.05 -	N52 B30	6	1,1	ILZFR6D11	1208		ILZFR6D11
530 i Touring	E61	3.0	200	01.07 -	N53 B30	6		ZKBR7A-HTU	91785		ZKBR7A-HTU
535 d Touring	E61	3.0	200	09.04 -	M57 N D30	6	☑	Y-547AS	5968	47	
545 i Touring	E61	4.4	245	05.04 - 08.05	N62 B44	8		BKR6EQUP	3199	30	LPG 1
550 i Touring	E61	4.8	270	02.05 -	N62 B48	8	1,1	IZFR6H11	4294		IZFR6H11

**5ER F10**

523 i	F10	3.0	150	03.10 -	N53 B30	6		ZKBR7A-HTU	91785		ZKBR7A-HTU
528 i	F10	3.0	190	03.10 -	N53 B30	6		ZKBR7A-HTU	91785		ZKBR7A-HTU

**5ER F11**

523 i Touring	F11	3.0	150	08.10 -	N53 B30	6		ZKBR7A-HTU	91785		ZKBR7A-HTU
---------------	-----	-----	-----	---------	---------	---	--	------------	-------	--	------------

**6ER E63**

630 Ci	E63	3.0	190	02.04 -	N52 B30	6	1,1	ILZFR6D11	1208		ILZFR6D11
630 Ci	E63	3.0	200	04.06 -	N53 B30	6		ZKBR7A-HTU	91785		ZKBR7A-HTU
635 Cd	E63	3.0	210	05.06 -	M57 N2 D30	6	☑	Y-547AS	5968	47	
635 Ci	E63	3.6	200	09.04 -	N62 B36	8		BKR6EQUP	3199	30	LPG 1
645 Ci	E63	4.4	245	09.02 - 08.05	N62 B44	8		BKR6EQUP	3199	30	LPG 1
650 Ci	E63	4.8	270	10.05 -	N62 B48	8	1,1	IZFR6H11	4294		IZFR6H11
M6	E63	5.0	373	09.04 -	S85 B50	10		LKR8AP	4471		LKR8AP

**6ER E64**

630 Ci Cabrio	E64	3.0	190	09.04 -	N52 B30	6	1,1	ILZFR6D11	1208		ILZFR6D11
645 Ci Cabrio	E64	4.4	245	02.04 - 09.05	N62 B44	8		BKR6EQUP	3199	30	LPG 1
650 Ci Cabrio	E64	4.8	270	03.05 -	N62 B48	8	1,1	IZFR6H11	4294		IZFR6H11

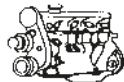
Code *l* kW

Cyl.



Stock-No.



LPG/CNG

**BMW****6ER E64**

M6 Cabrio	E64	5.0	373	07.05 -	S85 B50	10		LKR8AP	4471		LKR8AP
-----------	-----	-----	-----	---------	---------	----	--	--------	------	--	--------

**7ER E32**

730 i	E32	3.0	136	09.86 - 08.92	M30 B30	6	0,8	ZGR5A	5839	15	
730 i	E32	3.0	160	04.92 - 09.94	M60 B30	8		BKR6EK	2288	20	LPG 1
735 i	E32	3.4	155	09.86 - 07.92	M30 B35	6	0,8	ZGR5A	5839	15	
740 i	E32	4.0	210	04.92 - 09.94	M60 B40	8		BKR6EK	2288	20	LPG 1
750 i	E32	5.0	220	09.87 - 09.94	M70 B50	12	0,7	ZFR5F	5165		LPG 6

**7ER E38**

725 Tds	E38	2.5	105	09.95 - 11.00	M51 D25	6	<input checked="" type="checkbox"/>	Y-924J	7906	1	
728 i	E38	2.8	142	09.95 - 08.98	M52 B28	6		BKR6EK	2288	20	LPG 1
728 i	E38	2.8	142	09.98 - 11.01	M52 B28	6		BKR6EQUP	3199	30	LPG 1
730 d	E38	3.0	142	09.98 - 12.01	M57 D30	6	<input checked="" type="checkbox"/>	Y-507J	2691	32	
730 i	E38	3.0	160	09.94 - 09.95	M60 B30	8		BKR6EK	2288	20	LPG 1
735 i	E38	3.5	175	03.96 - 08.98	M62 B35	8		BKR6EK	2288	20	LPG 1
735 i	E38	3.5	175	09.98 -	M62 B35	8		BKR6EQUP	3199	30	LPG 1
740 i	E38	4.0	210	09.94 - 05.95	M60 B40	8		BKR6EK	2288	20	LPG 1
740 i	E38	4.4	210	05.95 - 08.98	M62 B44	8		BKR6EK	2288	20	LPG 1
740 i	E38	4.4	210	09.99 - 11.01	M62 B44	8		BKR6EQUP	3199	30	LPG 1
750 i	E38	5.4	240	11.94 -	M73 B54	12		BKR6EQUP	3199	30	LPG 1

**7ER E65**

730 d	E65	3.0	150	11.01 - 02.05	M57 N D30	6	<input checked="" type="checkbox"/>	Y-547AS	5968	47	
730 d	E65	3.0	170	07.04 -	M57 N2 D30	6	<input checked="" type="checkbox"/>	Y-547AS	5968	47	
730 i	E65	3.0	170	10.02 - 02.05	M54 B30	6		BKR6EQUP	3199	30	LPG 1
730 i	E65	3.0	190	03.05 -	N52 B30	6	1,1	ILZFR6D11	1208		ILZFR6D11
735 i	E65	3.6	200	07.01 - 02.05	N62 B36	8		BKR6EQUP	3199	30	LPG 1
740 i	E65	4.0	225	01.05 -	N62 B40	8	1,1	IZFR6H11	4294		IZFR6H11
745 i	E65	4.4	245	07.01 - 02.05	N62 B44	8		BKR6EQUP	3199	30	LPG 1
750 i	E65	4.8	270	01.05 -	N62 B48	8	1,1	IZFR6H11	4294		IZFR6H11
760 i	E65	6.0	327	01.03 -	N73 B60	12		BKR6EQUP	3199	30	LPG 1

**8ER E31**

840 Ci	E31	4.0	210	12.93 - 02.96	M60 B40	8		BKR6EK	2288	20	LPG 1
840 Ci	E31	4.4	210	03.96 - 05.99	M62 B44	8		BKR6EK	2288	20	LPG 1
850 Ci	E31	5.0	220	05.89 - 10.94	M70 B50	12	0,7	ZFR5F	5165		LPG 6
850 Ci	E31	5.4	240	10.94 - 05.99	M73 B54	12		BKR6EQUP	3199	30	LPG 1
850 CSI	E31	5.6	280	02.93 - 11.96	S70 B56	12	0,7	ZFR5F	5165		LPG 6

**X1 E84**

X 1 Xdrive18i	E84	2.0	110	09.08 -	N46 B20	4	1,1	IZFR6H11	4294		IZFR6H11
X 1 Xdrive25i	E84	3.0	160	09.08 -	N52 B30	6	1,1	PLZFR6A11S	5987		
X 1 Xdrive28i	E84	3.0	190	09.08 -	N52 B30	6	1,1	PLZFR6A11S	5987		

**X3 E83**

X 3 xDrive20d 4x4	E83	2.0	110	09.04 -	M47 N D20	4	<input checked="" type="checkbox"/>	Y-547AS	5968	47	
X 3 xDrive20i 4X4	E83	2.0	110	09.05 -	N46 B20	4	1,1	IZFR6H11	4294		IZFR6H11
X 3 xDrive25i 4x4	E83	2.5	141	01.04 -	M54 B25	6		BKR6EQUP	3199	30	LPG 1
X 3 xDrive25i 4x4	E83	2.5	160	08.06 -	N52 B25	6	1,1	ILZFR6D11	1208		ILZFR6D11
X 3 xDrive30d 4x4	E83	3.0	150	01.03 - 09.05	M57 N D30	6	<input checked="" type="checkbox"/>	Y-547AS	5968	47	
X 3 xDrive30d 4x4	E83	3.0	160	10.04 -	M57 N2 D30	6	<input checked="" type="checkbox"/>	Y-547AS	5968	47	
X 3 xDrive30i 4x4	E83	3.0	170	01.04 -	M54 B30	6		BKR6EQUP	3199	30	LPG 1
X 3 xDrive30i 4x4	E83	3.0	200	06.06 -	N52 B30	6	1,1	ILZFR6D11	1208		ILZFR6D11
X 3 xDrive35d 4x4	E83	3.0	210	09.06 -	M57 N2 D30	6	<input checked="" type="checkbox"/>	Y-547AS	5968	47	

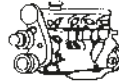

Code *l* kW

Cyl.



Stock-No.



LPG/CNG

**BMW****X5 E53**

X 5d	4x4	E53	3.0	142	08.01 - 11.03	M57 D30	6	☑	Y-507J	2691	32	
X 5d	4x4	E53	3.0	160	01.03 - 09.06	M57 N D30	6	☑	Y-547AS	5968	47	
X 5i	4x4	E53	3.0	170	08.99 - 09.06	M54 B30	6		BKR6EQUP	3199	30	LPG 1
X 5i	4x4	E53	4.4	210	10.98 - 09.03	M62 B44	8		BKR6EQUP	3199	30	LPG 1
X 5i	4x4	E53	4.4	235	01.03 - 09.06	N62 B44	8		BKR6EQUP	3199	30	LPG 1
X 5 4.6 iS	4x4	E53	4.6	255	01.01 - 09.03	M62 B46	8		BKR6EQUP	3199	30	LPG 1
X 5 4.8 iS	4x4	E53	4.8	265	11.03 - 09.06	N62 B48	8	1,1	IZFR6H11	4294		IZFR6H11

**X5 E70**

X 5d	4x4	E70	3.0	173	07 -	M57 N2 D30	6	☑	Y-547AS	5968	47	
X 5i 3.0 si	4x4	E70	3.0	200	02.07 -	N52 B30	6	1,1	ILZFR6D11	1208		ILZFR6D11
X 5 3.0 sd	4x4	E70	3.0	210	07 -	M57 N2 D30	6	☑	Y-547AS	5968	47	
X 5 4.8 iS	4x4	E70	4.8	261	02.07 -	N62 B48	8	1,1	IZFR6H11	4294		IZFR6H11

**Z3 E36/7**

Z 3		E36/7	1.8	85	02.96 - 09.98	M43 B18	4		BKR6EK	2288	20	LPG 1
Z 3		E36/7	1.8	85	01.98 - 02.99	M43 B18	4		BKR6EQUP	3199	30	LPG 1
Z 3		E36/7	1.9	87	03.99 - 06.02	M43 B19	4		BKR6EQUP	3199	30	LPG 1
Z 3		E36/7	1.9	103	11.95 - 03.99	M44 B19	4		BKR6EK	2288	20	LPG 1
Z 3		E36/7	2.0	110	09.98 - 12.00	M52 B20	6		BKR6EQUP	3199	30	LPG 1
Z 3		E36/7	2.2	125	12.99 - 06.02	M54 B22	6		BKR6EQUP	3199	30	LPG 1
Z 3		E36/7	2.8	142	06.96 - 09.98	M52 B28	6		BKR6EK	2288	20	LPG 1
Z 3		E36/7	2.8	142	01.98 - 05.00	M52 B28	6		BKR6EQUP	3199	30	LPG 1
Z 3 Coupé		E36/7	2.8	142	01.98 - 12.00	M52 B28	6		BKR6EQUP	3199	30	LPG 1
Z 3		E36/7	3.0	170	09.99 - 06.02	M54 B30	6		BKR6EQUP	3199	30	LPG 1
Z 3 Coupé		E36/7	3.0	170	09.99 - 06.02	M54 B30	6		BKR6EQUP	3199	30	LPG 1
Z 3 M		E36/7	3.2	236	04.96 - 06.00	S50 B32	6	0,7	PKR7A	3641		PKR7A
Z 3 M		E36/7	3.2	239	03.00 - 05.02	S54 B32	6		DCPR8EKP	7415		
Z 3 M Coupé		E36/7	3.2	236	09.97 - 07.00	S50 B32	6	0,7	PKR7A	3641		PKR7A
Z 3 M Coupé		E36/7	3.2	239	03.00 - 05.02	S54 B32	6		DCPR8EKP	7415		

**Z4 E85**

Z 4		E85	2.0	110	09.04 -	N46 B20	4	1,1	IZFR6H11	4294		IZFR6H11
Z 4		E85	2.2	125	09.03 -	M54 B22	6		BKR6EQUP	3199	30	LPG 1
Z 4		E85	2.5	130	07 -	N52 B25	6	1,1	ILZFR6D11	1208		ILZFR6D11
Z 4		E85	2.5	141	04.03 -	M54 B25	6		BKR6EQUP	3199	30	LPG 1
Z 4si		E85	2.5	160	10.04 -	N52 B25	6	1,1	ILZFR6D11	1208		ILZFR6D11
Z 4		E85	3.0	170	04.03 -	M54 B30	6		BKR6EQUP	3199	30	LPG 1
Z 4 si		E85	3.0	195	10.05 -	N52 B30	6	1,1	ILZFR6D11	1208		ILZFR6D11
Z 4 M		E85	3.2	252	03.06 -	S54 B32	6		DCPR8EKP	7415		

**Z4 E86**

Z 4 si Coupé		E86	3.0	195	10.05 -	N52 B30	6	1,1	ILZFR6D11	1208		ILZFR6D11
Z 4 M Coupé		E86	3.2	252	10.05 -	S54 B32	6		DCPR8EKP	7415		

**Z4 E89**

Z 4 23i		E89	2.5	150	05.09 -	N52 B25	6	1,1	PLZFR6A11S	5987		
Z 4 30i		E89	3.0	190	05.09 -	N52 B30	6	1,1	PLZFR6A11S	5987		

**Z8 E52**

Z 8		E52	5.0	294	06.00 - 07.03	S62 B50	8		BKR6EQUP	3199	30	LPG 1
-----	--	-----	-----	-----	---------------	---------	---	--	----------	------	----	-------

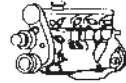
Code *l* kW

Cyl.



Stock-No.



LPG/CNG

**BUICK**

Century		2.2		93 - 94	4	4	1,0	TR4	3754		LPG 5
Century		2.2		95 - 96	4	4	1,5	TR55-1	2683		TR55-1IX
Century		3.1		94 - 99	M OHV V6	6	1,3	TR55IX	7164		LPG 5
Century		3.1		00 -	J OHV V6	6	1,3	TR55IX	7164		LPG 5
Lacrosse		3.6		05 -	V6 2 FI	6	1,5	TR55	3951		LPG 5
Lacrosse		3.6		05 -	V6 7 FI 217	6	1,0	PLTR6A-10G	3587		PLTR6A-10G
LeSabre		3.8		92 - 95	L V6	6	1,5	PTR4B-15	5146		LPG 5
LeSabre		3.8		96 - 01	K V6	6	1,5	PTR4B-15	5146		LPG 5
LeSabre		3.8		02 -	K V6	6	1,5	PTR4B-15	5146		LPG 5
Park Avenue		3.8		91 -	K V6	6	1,5	PTR4B-15	5146		LPG 5
Park Avenue		3.8		92 - 97	1 V6 Super Charged	6	1,5	PTR4B-15	5146		LPG 5
Park Avenue		3.8		02 -	V6 1 FI Supercharged	6	1,5	TR55	3951		LPG 5
Park Avenue		3.8		02 -	V6 K FI	6	1,5	TR55	3951		LPG 5
Regal		3.8		96 -	K V6 MFI	6	1,5	PTR4B-15	5146		LPG 5
Regal		3.8		96 -	SC V6 MFI 1	6	1,5	PTR4B-15	5146		LPG 5
Rivera		3.8		96 - 97	K V6 MFI	6	1,5	PTR4B-15	5146		LPG 5
Rivera		3.8		96 -	SC V6 MFI 1	6	1,5	PTR4B-15	5146		LPG 5

**CADILLAC**

Allante		4.6		91 - 94	8 / 9 MFI	8	1,5	TR55	3951		LPG 5
BLS 1.9 D		1.9	110	04.06 -	Z19DTH	4		YE07	6092		
Brougham		5.0		91 - 92	E TBI	8	1,1	UR4	6630		UR5IX
Brougham		5.7		91 - 92	7 TBI	8	1,3	UR5	2771		UR6IX
Brougham		5.7		93 -	7 TBI	8	1,1	UR4	6630		UR5IX
Catera		3.0		97 - 01	R DOHC MFI	6		BKR5EK	7956	23	LPG 1
Concours		4.6		94 - 94	Y SFI	8	1,5	TR55	3951		LPG 5
Concours		4.6		95 - 95	Y MFI	8	1,5	TR55	3951		LPG 5
Concours		4.6		96 - 98	9 MFI	8	1,5	TR55	3951		LPG 5
CTS-V		5.7	298	05 -		8	1,5	TR55	3951		LPG 5
De Ville		4.6		96 - 98	Y MFI	8	1,5	TR55	3951		LPG 5
De Ville		4.6		99 -	Y MFI	8	1,5	TR55	3951		LPG 5
De Ville		4.6		01 -	9 MFI	8	1,5	TR55	3951		LPG 5
De Ville		4.9		91 - 91	B MFI	8	1,5	TR55	3951		LPG 5
De Ville		4.9		92 - 95	B MFI	8	1,5	TR55	3951		LPG 5
DeVille		6.0		81 -	9 EFI CID368	8	1,2	GR45	2822		GR5IX
Eldorado		4.6		93 - 93	9 / Y MFI	8	1,5	TR55	3951		LPG 5
Eldorado		4.6		94 - 98	9 MFI / SFI	8	1,5	TR55	3951		LPG 5
Eldorado		4.6		94 - 98	Y MFI / SFI	8	1,5	TR55	3951		LPG 5
Eldorado		4.6		99 -	V8 MFI 9	8	1,5	TR55	3951		LPG 5
Eldorado		4.6		99 -	V8 MFI Y	8	1,5	TR55	3951		LPG 5
Eldorado		4.9		92 - 93	B MFI	8	1,5	TR55	3951		LPG 5
Seville		4.6		99 -	V8 MFI 9	8	1,5	TR55	3951		LPG 5
Seville		4.6		99 -	V8 MFI Y	8	1,5	TR55	3951		LPG 5
SRX Sport Luxury		4.6	239	10.04 -	A V8 FI	8	1,5	TR55	3951		LPG 5
XLR		4.6	239	05 -	A V8 FI	8	1,5	TR55	3951		LPG 5

**CATERHAM**

Super Seven				85 -		4	0,6	B8ECS	2841		
Super Seven HPC		2.0	110	07.91 -	Opel 16V	4	0,8	BCPR7ES	3330		BCPR7EIX

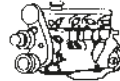
Code *l* kW

Cyl.

Stock-No.  
**VETINE**  
BY-PROMOTER

LPG/CNG

**CHEVROLET****ALERO**

Alero		3.4		03.99 -	LA1	6	1,5	TR55	3951		LPG 5
-------	--	-----	--	---------	-----	---	-----	------	------	--	-------

**AVEO**

Aveo 1.2		1.2	53	02.05 - 08	F12S3	4	1,1	BPR5EY-11	3028		LPG 2
Aveo 1.2		1.2	62	08 -	B12D1	4	0,9	DCPR8E	4339		LPG 8
Aveo 1.4		1.4	69	02.05 - 08	F14D3	4	1,1	BKR6E-11	2756	14	LPG 1
Aveo 1.4		1.4	74	08 -	F14D4	4	1,1	ZFR6F-11	4291		LPG 6

**BLAZER**

Blazer		4.3		95 - 05	V6 W EFI	6	1,3	UR5	2771		UR6IX
Blazer		4.3		96 - 02	V6 W EFI	6	1,0	TR5	2238		LPG 5
Blazer		4.3		03 - 03	V6 X EFI	6	1,0	TR5	2238		LPG 5
Blazer		5.7		87 - 93	V8 K EFI	8	1,3	UR5	2771		UR6IX
Blazer		5.7		87 - 93	V8 K TBI	8	1,3	UR5	2771		UR6IX
Blazer		5.7		94 - 94	V8 K EFI	8	1,3	UR6	7773		UR6IX
Blazer		5.7		94 -	V8 K TBI	8	1,3	UR6	7773		UR6IX

**CAMARO**

Camaro		2.8		82 -	1 2 bbl CID173	6	1,3	UR5	2771		UR6IX
Camaro		3.1		90 - 92	T V6 EFI	6	1,3	UR5	2771		UR6IX
Camaro		3.4		93 - 95	S V6 EFI	6	1,3	UR5	2771		UR6IX
Camaro		3.8		96 -	V6 MFI K	6	1,5	TR55	3951		LPG 5
Camaro		3.8		01 -		6	1,5	PTR4B-15	5146		LPG 5
Camaro		5.0		82 -	7 EFI CID305	8	1,1	UR4	6630		UR5IX
Camaro		5.0		83 -	S EFI CID305	8	1,1	UR4	6630		UR5IX
Camaro		5.0		85 - 92	F V8 EFI	8	1,1	UR4	6630		UR5IX
Camaro		5.0		88 - 92	E V8 EFI	8	1,1	UR4	6630		UR5IX
Camaro		5.7		87 - 92	V8 EFI Alu Heads	8	0,9	FR4	5188		
Camaro		5.7		87 - 92	V8 EFI Cast Iron Heads	8	1,1	UR4	6630		UR5IX
Camaro		5.7		93 - 97	P V8 EFI	8	1,5	TR55	3951		LPG 5
Camaro		5.7		98 - 02	G V8 EFI	8	1,5	TR55	3951		LPG 5

**CAPTIVA**

Captiva 2.4		2.4	100	09.06 -	Z24SED	4		BKR5EK	7956	23	LPG 1
Captiva 3.2		3.2	169	09.06 -	Z32SED	6	1,3	PTR5A-13	2467	25	LPG 4

**CORVETTE**

Corvette		5.7	294	97 - 00	G V8 EFI	8	1,5	TR55	3951		LPG 5
Corvette		5.7		86 - 91	8 V8 EFI Alu Heads	8	0,9	FR4	5188		
Corvette		5.7		88 - 91	8 V8 EFI Cast Iron Heads	8	1,1	UR4	6630		UR5IX
Corvette		5.7		90 - 92	J V8 EFI ZR1	8	1,5	TR55	3951		LPG 5
Corvette		5.7		92 - 96	P V8 EFI	8	1,5	TR55	3951		LPG 5
Corvette		5.7		93 - 95	J V8 EFI	8	1,5	TR55	3951		LPG 5
Corvette		5.7		96 - 96	5 V8 EFI	8	1,5	TR55	3951		LPG 5
Corvette		5.7		01 - 03	G V8 EFI	8	1,5	TR55	3951		LPG 5
Corvette		5.7		01 - 01	S V8 EFI	8	1,5	TR55	3951		LPG 5
Corvette		5.7		03 - 04	V8	8	1,5	PZTR5A-15	7862		PZTR5A-15
Corvette		6.0		05 -	V8	8	1,5	PZTR5A-15	7862		PZTR5A-15

**CRUZE**

Cruze 1.6	J300 / J305	1.6	83	05.09 -	F16D4	4	1,1	ZFR6F-11	4291		LPG 6
Cruze 1.6	J300 / J305	1.6	91	05.09 -	F16D4	4	1,1	ZFR6F-11	4291		LPG 6
Cruze 1.8	J300 / J305	1.8	104	05.09 -	F18D4	4	1,1	ZFR6F-11	4291		LPG 6

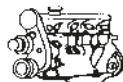
Code *l* kW

Cyl.



Stock-No.



LPG/CNG

**CHEVROLET  
EPICA**

Epica	KL1	2.0	106	06.06 -	XK	6		BKUR6ETB	6992		
Epica	KL1	2.5	115	06.06 -		6	1,1	IFR6E11	6741		IFR6E11

**EVANDA**

Evanda		2.0	96	02.05 -	T20SED DOHC 16v	4		BKR5EK	7956	23	LPG 1
--------	--	-----	----	---------	-----------------	---	--	--------	------	----	-------

**KALOS**

Kalos 1.2		1.2	53	02.05 -	B12S1	4	1,1	BPR5EY-11	3028		LPG 2
Kalos 1.4		1.4	61	02.05 -	F14S3 SOHC	4	0,8	BPR6ES	7822	2	LPG 2
Kalos 1.4 16V SX		1.4	69	02.05 -	F14D3 DOHC	4	1,1	BKR6E-11	2756	14	LPG 1

**LACETTI**

Lacetti		1.4	70	02.05 -	F14D3	4	1,1	BKR6E-11	2756	14	LPG 1
Lacetti		1.6	80	02.05 -	F16D3	4	1,1	BKR6E-11	2756	14	LPG 1
Lacetti		1.8	89	02.05 -	T18SED	4		BKR5EK	7956	23	LPG 1
Lacetti 1.8		1.8	89	08.05 -	F18D3	4		BKUR6ETB	6992		

**LUMINA**

Lumina		3.8		98 -	V6 MFI K	6	1,5	PTR4B-15	5146		LPG 5
--------	--	-----	--	------	----------	---	-----	----------	------	--	-------

**MALIBU**

Malibu		2.4		97 - 99	T MFI DOHC	4	1,5	TR55	3951		LPG 5
Malibu		3.1		97 - 99	M V6 MFI	6	1,5	TR55	3951		LPG 5
Malibu		3.1		00 -	J V6 SFI	6	1,5	TR55	3951		LPG 5

**MATIZ**

Matiz		0.8	38	02.05 -	F8CV	3	1,1	BCPR5EY-11	4120		LPG 3
Matiz		1.0	47	02.05 -	B10S	4	1,1	BCPR5EY-11	4120		LPG 3

**METRO**

Metro		1.0		98 -	L3 TBI 6	3	1,1	BPR6ES-11	4824	13	LPG 2
-------	--	-----	--	------	----------	---	-----	-----------	------	----	-------

**NUBIRA**

Nubira 1.6		1.6	80	02.05 -	A16DMS DOHC	4	1,1	BKR6E-11	2756	14	LPG 1
Nubira 1.8 CDX		1.8	89	02.05 -	T18SED	4		BKR5EK	7956	23	LPG 1
Nubira 1.8		1.8	89	08.05 -	F18D3	4		BKUR6ETB	6992		

**PRIZUM**

Prizum		1.8		98 - 99	L4 MPI 8 DOHC	4		BKR5EKB-11	3967		
Prizum		1.8		00 -	L4 MPI 8 DOHC	4	1,1	IFR5T11	4996		IFR5T11

**REZZO / TACUMA**

Rezzo / Tacuma U100		1.6	77	02.05 -	A16DMS	4	1,1	BKR5E-11	6953	33	LPG 1
Rezzo / Tacuma		1.8	72	00 -	F18S2 SOHC	4	0,9	BPR5ES	7422	6	LPG 2
Rezzo / Tacuma U100		2.0	89	02.05 -	T20SED	4		BKR5EK	7956	23	LPG 1

**TAHOE**

Tahoe		4.8		00 - 00	V FI V8	8	1,5	TR55	3951		LPG 5
Tahoe		4.8		01 -	V FI V8	8	1,5	TR55	3951		LPG 5
Tahoe		5.3	201	00 -	T FI V8	8	1,5	TR55	3951		LPG 5
Tahoe		5.3		02 - 03	Z FLEX V8	8	1,5	TR55	3951		LPG 5
Tahoe		5.3		04 -	Z FI V8	8	1,5	TR55	3951		LPG 5
Tahoe		5.3		05 -	Z FLEX V8 323	8	1,5	TR55	3951		LPG 5
Tahoe		5.7	147	04.96 - 00	R V8	8	1,5	TR55	3951		LPG 5

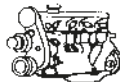

Code *l* kW

Cyl.



Stock-No.

VEMO

E-PROMER

LPG/CNG

**CHEVROLET****TRAIL BLAZER**

Trail Blazer 4.2 LTZ		4.2	201	02 - 03	S EFI	6	1,3	PTR5A-13	2467	25	LPG 4
Trail Blazer 5.3		5.3		03 -	V8 P EFI	8	1,5	TR55	3951		LPG 5

**CHRYSLER****300**

300		2.7		05 -	V6 R FI Dir. Ign.	6	1,3	LZTR5A-13	4612		
-----	--	-----	--	------	-------------------	---	-----	-----------	------	--	--

**300C**

300 C		2.7	142	01.05 -	V6	6	1,3	LZTR5A-13	4612		
300 C 3.0 CRD		3.0	160	09.05 - 12.10	M664	6		Y8002AS	6287	51	
300 C		3.5	183	07.04 -	V6 G FI	6	1,3	ZFR5LP-13G	7781		ZFR5LP-13G
300 C (Twin Spark)		5.7	250	07.04 - 08	V8 HEMI	8	1,1	LZTR4A-11	5444		
300 C SRT8 (Twin Spark)		6.1	316	06 -	W V	8	1,3	LZTR5A-13	4612		

**300M**

300 M		2.7	150	08.00 - 09.04	V6 EER	6	1,3	LZTR5A-13	4612		
300 M		3.5	189	09.99 -	V6 G FI	6	1,3	ZFR5LP-13G	7781		ZFR5LP-13G
300 M		3.5		03 -	V6 K FI Dir.Ign.	6	1,3	ZFR5LP-13G	7781		ZFR5LP-13G

**CIRRUS**

Cirrus		2.4		99 -	X DOHC	4	1,3	FR45	4636		
Cirrus		2.5		95 -	V6 MPI H DOHC	6	1,1	PFR5G-11	2647		PFR6G-11

**CONCORDE**

Concorde		2.7		98 -	V6 MPI R DOHC	6	1,3	PTR5A-13	2467	25	LPG 4
Concorde		3.3		93 - 96	V6 MPI T	6	1,2	GR45	2822		GR5IX
Concorde		3.3		94 - 94	V6 FF U	6	1,2	GR45	2822		GR5IX
Concorde		3.5		93 - 97	V6 MPI F	6	0,9	FR5-1	7252		

**CROSSFIRE**

Crossfire		3.2	160	03 -	engine Mercedes SLK	6	1,0	IFR6D10	5344		LPG 1
-----------	--	-----	-----	------	---------------------	---	-----	---------	------	--	-------

**DODGE VIPER**

Dodge Viper		8.0		96 -	E MPI V10	10	0,9	FR5-1	7252		
-------------	--	-----	--	------	-----------	----	-----	-------	------	--	--

**NEON**

Neon		1.8		03.98 - 10.99		4	0,9	BKR6E	6962	28	LPG 1
Neon LE		2.0	98	01.95 -	ECB 16V	4	0,8	BCPR6ES	2330	12	LPG 3

**PT CRUISER**

PT Cruiser 2.0		2.0	104	06.00 -		4	1,1	LZTR4A-11	5444		
PT Cruiser 2.2 CRD		2.2	89	03.02 -	EDJ	4		Y-745U	6346	11	
PT Cruiser 2.2 CRD		2.2	110	08.05 -		4		Y-745U	6346	11	
PT Cruiser 2.4		2.4	105	08.05 -	EDZ	4	1,1	LZTR4A-11	5444		
PT Cruiser 2.4		2.4	110	06.00 -	EDZ	4	1,1	LZTR4A-11	5444		
PT Cruiser GT 2.4		2.4	164	08.03 -	EDV	4	1,1	LZTR4A-11	5444		

**SEBRING**

Sebring 2.0 CRD		2.0	103	07 -	engine by VW	4		Y-607AS	7560	50	
Sebring 2.0		2.0	104	06.01 -	EC4	4	1,1	LZTR4A-11	5444		
Sebring 2.0		2.0		95 - 99	L4 MPI Y DOHC	4	1,1	BKR6EVX-11	3540		LPG 1
Sebring 2.4		2.4		96 - 98	L4 MPI X DOHC	4	1,1	FR45	4636		
Sebring 2.4		2.4		01 -	4G64 SOHC	4	1,1	BKR5E-11	6953	33	LPG 1
Sebring 2.5		2.5		95 - 99	V6 MPI N DOHC	6	1,1	PFR5G-11	2647		PFR6G-11

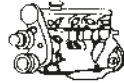
Code *l* kW

Cyl.



Stock-No.



LPG/CNG

**CHRYSLER  
STRATUS**

Stratus 2.0		2.0	96	00 -		4	0,9	BKR6E	6962	28	LPG 1
Stratus 2.0		2.0	98	95 - 00	ECB 16V	4	0,8	BCPR6ES	2330	12	LPG 3
Stratus 2.5		2.5	120	04.95 -	EEB V6 MPI	6	1,1	PFR6B-11	4014		PFR7B

**VOYAGER 1**

Voyager 1 3.0		3.0	100	88 - 91	EFA	6	1,1	BPR5ES-11	4424		LPG 2
---------------	--	-----	-----	---------	-----	---	-----	-----------	------	--	-------

**VOYAGER 2**

Voyager 2 2.0		2.0	98	97 - 01.01	ECB C00	4	0,9	BKR6E	6962	28	LPG 1
Voyager 2 2.4		2.4	110	96 - 01.01	EDZ B00	4	1,1	ZFR5A-11	5084		LPG 6
Voyager 2 2.5		2.5	72	91 - 95	EDM	4	0,8	BPR6ES	7822	2	LPG 2
Voyager 2 2.5 TD		2.5	88	04.92 - 04.95	VM 425 CLIRE	4	█	Y-923U	3380	1	
Voyager 2 2.5 TD		2.5	88	04.92 - 04.95	VM HR-492	4	█	Y-923U	3380	1	
Voyager 2 2.5 TD		2.5	88	05.95 - 01.01	VM HR425 CLIEE	4	█	Y-741U	6943	20	
Voyager 2 3.3		3.3	116	96 - 01.01	EGA V6 MPI R	6	0,9	GR4IX	7149		GR5IX
Voyager 2 3.3		3.3	120	91 - 95	EGA V6 MPI R	6	1,3	GR4	7038		GR5IX
Voyager 2 3.8		3.8	122	96 - 01.01	EGH V6 MPI	6	0,9	GR4	7038		GR5IX

**VOYAGER 3**

Voyager 3 2.4		2.4	108	03.01 -	EDZ	4	1,3	LZTR5A-13	4612		
Voyager 3 2.4		2.4	112	00 -		4	1,3	FR45	4636		
Voyager 3 23.3		3.3	128	03.01 -	EGA	6	1,3	LZTR5A-13	4612		

**VOYAGER 4**

Voyager 4 2.5 CRD	RG	2.5	88	08.05 - 05.07	EDK / ENJ	4	█	Y1031J	95970	71	
Voyager 4 2.5 CRD	RG	2.5	105	02.00 - 05.07	ENC	4	█	Y1031J	95970	71	
Voyager 4 2.8 CRD	RG	2.8	110	06.04 - 02.08	ENR	4	█	Y1031J	95970	71	

**CITROEN  
AX**

AX 1.0i		1.0	30	10.86 -	TU9	4	0,7	BCP6ES	4930	17	LPG 3
AX 1.0i		1.0	37	07.92 -	TU9.M Cat.	4		BKR5EK	7956	23	LPG 1
AX 1.0i		1.0	37	03.95 -	TU9M CDZ	4		BKR5EK	7956	23	LPG 1
AX 1.0i		1.0		09.86 - 06.92	TU9 C1A	4	0,8	BCP5ES	7496	16	LPG 3
AX 1.0i		1.0		07.92 - 02.95	TU9M CDZ	4	0,8	BCPR5ES	6130	32	LPG 3
AX 1.1		1.1	44	07.92 - 06.95	TU1M HDZ Cat.	4	0,8	BCPR5ES	6130	32	LPG 3
AX 1.1i		1.1		09.86 - 06.92	TU1 H1A	4	0,8	BCP5ES	7496	16	LPG 3
AX 1.1i		1.1		07.92 - 06.95	TU1M HDZ	4	0,8	BCPR5ES	6130	32	LPG 3
AX 1.1i		1.1		07.95 -	TU1M HDZ	4		BKR5EK	7956	23	LPG 1
AX 1.3i Sport		1.3	69	02.87 - 12.92	TU24 M4A	4		BKUR7ET	7873		PFR7Q
AX D		1.4	39	09.88 - 09.94	TUD 3 L	4	█	Y-910J	3617	3	
AX 1.4i		1.4	55	07.92 -	TU3MC Cat.	4		BKR6EK	2288	20	LPG 1
AX 1.4i GT		1.4	55	07.92 -	TU3FM Cat.	4		BKR6EK	2288	20	LPG 1
AX 1.4i		1.4	55	07.94 -	TU3FM	4		BKR6EK	2288	20	LPG 1
AX 1.4		1.4		09.86 - 12.92	TU3 K1A, TU3A K1G	4	0,8	BCP5ES	7496	16	LPG 3
AX 1.4 GT		1.4		10.87 - 12.92	TU3S K2A	4	0,7	BCP6ES	4930	17	LPG 3
AX 1.4 Gti		1.4		09.91 - 12.92	TU3J2 K6B	4		BKR6EK	2288	20	LPG 1
AX 1.4i Gti		1.4		09.91 - 12.92	TU3FJ2Z	4		BKR6EK	2288	20	LPG 1
AX 1.4		1.4		07.92 -	TU3M Cat.	4	0,8	BCPR5ES	6130	32	LPG 3
AX 1.4 Gti		1.4		07.92 -	TU3J2 KFZ	4		BKR6EK	2288	20	LPG 1
AX 1.4i		1.4		07.92 - 06.95	TU3MC KDX	4	0,8	BCPR5ES	6130	32	LPG 3
AX 1.4i GT		1.4		07.92 - 06.95	TU3MC KDX	4	0,8	BCPR5ES	6130	32	LPG 3
AX 1.4i		1.4		07.95 -	TU3MC KDX	4		BKR6EK	2288	20	LPG 1
AX D		1.5	40	10.94 - 12.99	TUD 5 VJZ	4	█	Y-503J	1009	10	

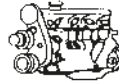
Code *l* kW

Cyl.



Stock-No.



LPG/CNG

**CITROËN****BERLINGO**

Berlingo 1.1i		1.1	44	07.96 -	TU1M HDZ	4		BKR6EK	2288	20	LPG 1
Berlingo 1.4i		1.4	55	07.96 - 12.99	TU3JP-KFX,KFW	4		BKR6EK	2288	20	LPG 1
Berlingo 1.4i		1.4	55	01.00 -	TU3JP KFX	4	0,9	BKR6EZ	4619	38	LPG 1
Berlingo Hdi		1.4	55	01.05 -	DV4TD	4	☑	YE04	1684	40	
Berlingo 1.6 Hdi 75		1.6	55	04.08 -	DV6BUTED4	4	☑	YE05	91322	73	
Berlingo 1.6 Hdi 75		1.6	55	04.08 -	DV6ETED / DV6ETEDM	4	☑	Y8001AS	8904	58	
Berlingo 1.6 Hdi		1.6	66	07.06 -	DV6	4	☑	YE04	1684	40	
Berlingo 1.6 Hdi 90		1.6	66	04.08 -	DV6ATED4	4	☑	YE05	91322	73	
Berlingo 1.6 95 Vti		1.6	72	07.10 -	EP6CDTR	4	0,8	PLZKBR7A-G	5843		PLZKBR7A-G
Berlingo 1.6 Hdi 110		1.6	80	04.08 -	DV6TED4	4	☑	YE05	91322	73	
Berlingo 1.6i 16V		1.6	81	02.01 -	TU5JP4 NFU	4	0,9	LFR6B	6677		LPG 7
Berlingo 1.6 Hdi 110		1.6	82	07.10 -	DV6C	4	☑	Y8001AS	8904	58	
Berlingo 1.6 120 Vti		1.6	88	11.09 -	EP6C	4	0,8	PLZKBR7A-G	5843		PLZKBR7A-G
Berlingo 1.8 D		1.8	43	07.96 - 08.98	XUD7 A9A	4	☑	Y-923U	3380	1	
Berlingo 1.8 D		1.8	43	09.98 - 03.99	XUD7 A9A	4	☑	Y-938R	5267	1	
Berlingo 1.8 D		1.8	51	09.98 - 03.99	DW8 WJZ	4	☑	Y-503R	4279	10	
Berlingo 1.8i		1.8	66	07.96 -	XU7JB LFX	4		BKR6EK	2288	20	LPG 1
Berlingo 1.8 D		1.8	66	09.98 - 03.99	DW8TD	4	☑	Y-503R	4279	10	
Berlingo 1.9 D		1.9	51	07.96 - 09.98	XUD9A D9B / DJY	4	☑	Y-923U	3380	1	
Berlingo 1.9 D		1.9	52	09.98 - 12.02	XUD9A	4	☑	Y-938R	5267	1	
Berlingo 2.0 Hdi		2.0	66	10.99 -	DW10TD	4	☑	Y-504J	1441	24	
Berlingo 2.0 Hdi		2.0	81	05.02 - 10.06	DW10ATED4	4	☑	Y1005J	7957	56	
Berlingo 2.0 Hdi		2.0	88	11.06 -	DW10UTED4	4	☑	Y1005J	7957	56	
Berlingo 2.0 Hdi		2.0	100	11.06 -	DW10BTED4	4	☑	Y1005J	7957	56	
Berlingo Multispace 1.4i		1.4	55	01.97 - 12.99	TU3JP KFX, KFW	4		BKR6EK	2288	20	LPG 1
Berlingo Multispace 1.4i		1.4	55	01.00 -	TU3JP KFX, KFW	4	0,9	BKR6EZ	4619	38	LPG 1
Berlingo Multispace 1.6i		1.6	81	02.01 -	TU5JP4 NFU	4	0,9	LFR6B	6677		LPG 7
Berlingo Multispace 1.8i		1.8	66	07.97 -	XU7JB LFX	4		BKR6EK	2288	20	LPG 1
Berlingo Multispace 1.9 D		1.9	51	01.97 - 09.98	XUD9A D9B / DJY	4	☑	Y-923U	3380	1	
Berlingo Multispace 1.9 D		1.9	51	09.98 - 12.02	DW8 WJZ	4	☑	Y-503R	4279	10	
Berlingo Multispace 2.0 Hdi		2.0	66	10.99 -	DW10TD	4	☑	Y-504J	1441	24	

**BX**

BX 17 D		1.8	44	07.85 - 01.93	XUD 7	4	☑	Y-924J	7906	1	
BX 17 TD, TRD		1.8	66	03.88 - 01.93	XUD 7 TE	4	☑	Y-924J	7906	1	
BX 19 D, TD, TRD		1.9	51	03.87 -	XUD 9 A/L	4	☑	Y-924J	7906	1	
BX 14		1.4	47	07.88 -	TU3.A	4	0,8	BCP5ES	7496	16	LPG 3
BX 15		1.5	59	07.87 - 06.92	XU5.1C	4	0,8	BCP5ES	7496	16	LPG 3
BX 16i Image, Millésime		1.6		07.92 -	XU5M BDY cat.	4	0,8	BCPR5ES	6130	32	LPG 3
BX 16		1.6	68	04.88 - 06.92	XU5.2C	4	0,7	BCP6ES	4930	17	LPG 3
BX 16 16V		1.6		07.87 - 06.92	XU9.J4	4		BCP6ET	4563		LPG 3
BX 16		1.6		07.92 -	XU5MZ BDZ Cat.	4	0,8	BCPR5ES	6130	32	LPG 3
BX 16 16V		1.6		07.92 -	XU9.J4 Cat.	4		BCPR6ET	2197		LPG 3
BX 19i Gti, Tri, Tzi / 4x4		1.9		07.86 - 06.92	XU9J2 D6A	4	0,7	BCP6ES	4930	17	LPG 3
BX 19i Gti 16S		1.9		07.87 - 06.92	XU9J4 D6C	4		BCP6ET	4563		LPG 3
BX 19i Gti 16S		1.9		07.92 -	XU9J4 DFW cat.	4		BCPR6ET	2197		LPG 3
BX 19		1.9	77	07.89 - 06.92	XU92C	4	0,7	BCP6ES	4930	17	LPG 3
BX 19		1.9	77	07.89 - 06.92	XU92C D2E	4	0,7	BCP6ES	4930	17	LPG 3
BX 19i Gti		1.9		07.88 - 06.92	XU9.J2	4	0,7	BCP6ES	4930	17	LPG 3
BX 19i		1.9		07.92 -	XU9.JA DKZ Cat.	4	0,8	BCPR5ES	6130	32	LPG 3

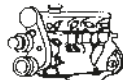
Code *l* kW

Cyl.



Stock-No.



LPG/CNG

**CITROEN****C1**

C1		1.0	50	06.05 -		3	1,1	LFR6C-11	5788		
C1 Hdi		1.4	40	05.06 -	DV4	4		YE04	1684	40	
C1 Hdi		1.4	50	06.05 -	DV4TD	4		YE05	91322	73	

**C15**

C15 D		1.8	44	10.84 - 05.95	XUD7	4		Y-924J	7906	1	
C15 D		1.8	44	06.95 -	XUD7	4		Y-938R	5267	1	
C15 D		1.9	44	12.00 -	DW8	4		Y-503R	4279	10	
C15 E		1.0	33	09.88 -	TU9 C1A	4	0,8	BCP5ES	7496	16	LPG 3
C15 E		1.1	44	09.92 - 06.95	TU1.M HDZ Cat.	4	0,8	BCPR5ES	6130	32	LPG 3
C15 E		1.1		10.88 -	TU1 H1A	4	0,8	BCP5ES	7496	16	LPG 3
C15 E		1.4		10.87 -	TU3A K1G	4	0,8	BCP5ES	7496	16	LPG 3
C15E		1.1		07.95 -	TU1M HDZ	4		BKR5EK	7956	23	LPG 1

**C2**

C2 1.1		1.1	45	08.03 -	TU1JP	4	0,9	BKR6EZ	4619	38	LPG 1
C2 1.4 Hdi		1.4	51	12.04 -	DV4TD	4		YE05	91322	73	
C2 1.4		1.4	55	08.03 -	TU3JP	4	0,9	BKR6EZ	4619	38	LPG 1
C2 1.6 Phase 2		1.6	80	05.08 -	DV6TED4	4		YE05	91322	73	
C2 1.6 16V		1.6	81	08.03 -	TU5JP4	4	0,9	LFR6B	6677		LPG 7
C2 1.6 16V		1.6	92	01.05 -	TU5JP4	4	0,9	LFR6B	6677		LPG 7

**C3 1**

C3 1.1		1.1	44	04.02 -	TU1A-HFX	4	0,9	BKR6EZ	4619	38	LPG 1
C3 1.1		1.1	44	04.02 -	TU1JP-HFZ, HFY	4	0,9	BKR6EZ	4619	38	LPG 1
C3 1.4 Hdi		1.4	51	12.04 -	DV4TD	4		YE05	91322	73	
C3 1.4 Hdi		1.4	52	03.02 - 12.04	DV4TD	4		YE04	1684	40	
C3 1.4		1.4	55	04.02 -	TU3A-KFV	4	0,9	BKR6EZ	4619	38	LPG 1
C3 /Pluriel 1.4		1.4	55	04.02 -	TU3JP-KFX, KFV	4	0,9	BKR6EZ	4619	38	LPG 1
C3 / Pluriel 1.4		1.4	55	03 -	TU3JP	4	0,9	BKR6EZ	4619	38	LPG 1
C3 1.4		1.4	66	10.03 -	ET3J4~KFU	4	0,8	LZKAR7A	6799		
C3 1.4 Hdi 16V		1.4	68	03.02 - 12.04	DV4TED4	4		YE04	1684	40	
C3 1.4 Hdi		1.4	68	12.04 - 08.05	DV4TED4	4		YE05	91322	73	
C3 1.4 Hdi 16V X-TR		1.4	68	04 - 12.04	DV4ETD4	4		YE04	1684	40	
C3 1.6 Hdi		1.6	66	10.05 -	DV6TED4	4		YE05	91322	73	
C3 /Pluriel 1.6		1.6	81	04.02 -	TU5JP4-NFU	4	0,9	LFR6B	6677		LPG 7
C3 / Pluriel 1.6 16V		1.6	81	03 -	TU5JP4	4	0,9	LFR6B	6677		LPG 7
C3 1.6 Hdi		1.6	81	03.06 -	DV4TED6	4		YE05	91322	73	

**C3 2**

C3 II 1.0 PureTech VTi 68		1.0	50	03.12 -	EB0	3	1,0	LZKR6AI-10G	97999		
C3 II 1.1		1.1	44	11.09 -	TU1A	4	0,9	BKR6EZ	4619	38	LPG 1
C3 II 1.2 PureTech VTi 82		1.2	60	03.12 -	EB2	3	1,0	LZKR6AI-10G	97999		
C3 II 1.4 Hdi 70		1.4	50	11.09 -	DV4C / DV4TD	4		YE05	91322	73	
C3 II 1.4		1.4	54	11.09 -	TU3A	4	0,9	BKR6EZ	4619	38	LPG 1
C3 II 1.4 95 VTi		1.4	72	11.09 -	EP3C	4	0,8	PLZKBR7A-G	5843		PLZKBR7A-G
C3 II 1.6 Hdi 90		1.6	66	11.09 -	DV6ATED4	4		YE05	91322	73	
C3 II 1.6 Hdi		1.6	68	11.09 -	DV6DTEd	4		YE05	91322	73	
C3 II 1.6 Hdi 110		1.6	82	11.09 -	DV6CTED4	4		Y8001AS	8904	58	
C3 II 1.6 VTi 120		1.6	88	11.09 -	EP6C	4	0,8	PLZKBR7A-G	5843		PLZKBR7A-G

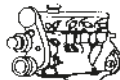

Code *l* kW

Cyl.



Stock-No.

V6TNE

E6-F01M2R2

LPG/CNG

**CITROËN****C3 PICASSO**

C3 Picasso 1.4 Vti 95		1.4	70	12.08 -	EP3	4	0,8	PLZKBR7A-G	5843		PLZKBR7A-G
C3 Picasso 1.6 Hdi 90		1.6	66	12.08 -	DV6ATED4	4	▣	YE05	91322	73	
C3 Picasso 1.6 Hdi 110		1.6	80	12.08 -	DV6TED4	4	▣	YE05	91322	73	
C3 Picasso 1.6 Vti 120		1.6	88	02.09 -	EP6	4	0,8	PLZKBR7A-G	5843		PLZKBR7A-G

**C4**

C4 1.4 16V		1.4	65	11.04 -	ET3J4~KFU	4	0,8	LZKAR7A	6799		
C4 Coupé 1.6 Hdi		1.6	68	12.04 -		4	▣	YE04	1684	40	
C4 Coupé 1.6 Hdi		1.6	80	12.04 - 06.06	DV6TED4	4	▣	YE04	1684	40	
C4 1.6 16V		1.6	81	11.04 -	TU5JP4~NFU	4	0,9	LFR6B	6677		LPG 7
C4 1.6 Vti 120		1.6	88	06.08 -	EP6	4	0,8	PLZKBR7A-G	5843		PLZKBR7A-G
C4 1.6 16V		1.6	103	06.08 -	EP6DT	4	0,8	PLZKBR7A-G	5843		PLZKBR7A-G
C4 1.6 16V		1.6	110	06.08 -	EP6DT	4	0,8	PLZKBR7A-G	5843		PLZKBR7A-G
C4 2.0 16V		2.0	100	11.04 -	EW10J4~RFN	4	0,9	LFR6B	6677		LPG 7
C4 2.0 Hdi		2.0	100	09.04 -	DW10BTED4	4	▣	Y1005J	7957	56	
C4 2.0 16V		2.0	103	11.04 -	EW10A	4	0,9	LFR5B	7113		LPG 7
C4 2.0 Hdi		2.0	103	07.08 -	DW10BTED4	4	▣	Y1005J	7957	56	
C4 2.0 16V		2.0		11.04 -	EW10A	4	0,9	LFR5B	7113		LPG 7

**C4 2**

C4 II 1.4 95 Vti		1.4	70	11.09 -	EP3C	4	0,8	PLZKBR7A-G	5843		PLZKBR7A-G
C4 II 1.6 HDi 90		1.6	68	11.09 -	DV6DTED / DV6DTEDM	4	▣	Y8001AS	8904	58	
C4 II 1.6 HDi 110		1.6	82	11.09 -	DV6C	4	▣	Y8001AS	8904	58	
C4 II 1.6 120 Vti		1.6	88	11.09 -	EP6C	4	0,8	PLZKBR7A-G	5843		PLZKBR7A-G
C4 II 1.6 155 THP		1.6	115	11.09 -	EP6CDT	4	0,8	PLZKBR7A-G	5843		PLZKBR7A-G
C4 II 2.0 HDi		2.0	110	11.09 -	DW10CTED4	4	▣	Y8001AS	8904	58	

**C4 AIRCROSS**

C4 Aircross 1.6 HDi 115		1.6	84	04.12 -	DV6C	4	▣	Y8001AS	8904	58	
C4 Aircross 1.6		1.6	86	04.12 -	4A92	4	1,1	DILFR5A11	93759		DILFR5A11

**C4 GRAND PICASSO**

C4 Grand Picasso 1.6 Hdi 110		1.6	80	09.06 -	DV6TED4	4	▣	YE05	91322	73	
C4 Grand Picasso 1.6 Hdi 110		1.6	82	09.10 -	DV6C	4	▣	Y8001AS	8904	58	
C4 Grand Picasso 1.6 Vti 120		1.6	88	06.08 -	EP6	4	0,8	PLZKBR7A-G	5843		PLZKBR7A-G
C4 Grand Picasso 1.6 16V		1.6	103	06.08 -	EP6DT	4	0,8	PLZKBR7A-G	5843		PLZKBR7A-G
C4 Grand Picasso 1.6 16V		1.6	110	06.08 -	EP6DT	4	0,8	PLZKBR7A-G	5843		PLZKBR7A-G
C4 Grand Picasso 1.6 THP 155		1.6	115	08.10 -	EP6CDT	4	0,8	PLZKBR7A-G	5843		PLZKBR7A-G
C4 Grand Picasso 1.8i 16V		1.8		09.06 -	EW7A	4	0,9	LFR5B	7113		LPG 7
C4 Grand Picasso 2.0 Hdi		2.0	100	02.07 -	DW10BTED4	4	▣	Y1005J	7957	56	
C4 Grand Picasso 2.0 Hdi		2.0	102	09.06 -	DW10TD	4	▣	Y-504J	1441	24	
C4 Grand Picasso 2.0		2.0	105	09.06 -	EW10A	4	0,9	LFR5B	7113		LPG 7
C4 Grand Picasso 2.0 Hdi 150		2.0	110	06.09 -	DW10CTED4	4	▣	Y8001AS	8904	58	
C4 Grand Picasso 2.0 Hdi 165		2.0	120	11.10 -	DW10CTED4	4	▣	Y8001AS	8904	58	

**C4 PICASSO**

C4 Picasso 1.6 Hdi		1.6	81	03.07 -	DV6TED	4	▣	YE05	91322	73	
C4 Picasso 1.6 Hdi		1.6	81	02.07 -	DV6TED4	4	▣	YE05	91322	73	
C4 Picasso 1.6 Hdi		1.6	82	09.10 -	DV6C	4	▣	Y8001AS	8904	58	
C4 Picasso 1.6 Vti 120		1.6	88	06.08 -	EP6	4	0,8	PLZKBR7A-G	5843		PLZKBR7A-G
C4 Picasso 1.6 16V		1.6	103	06.08 -	EP6DT	4	0,8	PLZKBR7A-G	5843		PLZKBR7A-G

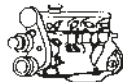
Code *l* kW

Cyl.



Stock-No.



LPG/CNG

**CITROEN  
C4 PICASSO**

C4 Picasso 1.6 16V		1.6	110	06.08 -	EP6DT	4	0,8	PLZKBR7A-G	5843		PLZKBR7A-G
C4 Picasso 1.6 THP 155		1.6	115	08.10 -	EP6CDT	4	0,8	PLZKBR7A-G	5843		PLZKBR7A-G
C4 Picasso 1.6 Hdi		1.6		12.08 -	DV6	4	☑	YE05	91322	73	
C4 Picasso 1.6 Hdi		1.6		12.08 -	DV6	4	☑	YE05	91322	73	
C4 Picasso 1.8i 16V		1.8		02.07 -	EW7A	4	0,9	LFR5B	7113		LPG 7
C4 Picasso 2.0 Hdi		2.0	100	10.06 -	DW10BTED4	4	☑	Y1005J	7957	56	
C4 Picasso 2.0 Hdi		2.0	102	02.07 -	DW10TD	4	☑	Y-504J	1441	24	
C4 Picasso 2.0		2.0	105	02.07 -	EW10A	4	0,9	LFR5B	7113		LPG 7
C4 Picasso 2.0 Hdi 150		2.0	110	06.09 -	DW10CTED4	4	☑	Y8001AS	8904	58	
C4 Picasso 2.0 Hdi 165		2.0	120	11.10 -	DW10CTED4	4	☑	Y8001AS	8904	58	
C4 Picasso 2.0 16V		2.0		02.07 -	EW10A	4	0,9	LFR5B	7113		LPG 7

**C5**

C5 1.6 Hdi		1.6	81	03.06 -	DV6	4	☑	YE05	91322	73	
C5 1.8		1.8	86	06.02 -	EW7J4 6FZ	4	0,9	LFR5B	7113		LPG 7
C5 2.0 Hdi		2.0	66	06.02 -	DW10ATD	4	☑	Y-504J	1441	24	
C5 2.0 Hdi		2.0	81	02.01 -	DW10ATED	4	☑	Y-504J	1441	24	
C5 2.0		2.0	100	10.00 -	EW10J4-RFN	4	0,9	LFR5B	7113		LPG 7
C5 2.0 Hdi		2.0	100	09.04 -	DW10BTED4	4	☑	Y1005J	7957	56	
C5 2.0		2.0	105	09.04 -	EW10A	4	0,9	LFR5B	7113		LPG 7
C5 2.0 16V		2.0		09.04 -	EW10A	4	0,9	LFR5B	7113		LPG 7
C5 2.2 Hdi		2.2	98	09.04 - 08.05	DW12TED4	4	☑	Y1005J	7957	56	
C5 2.2 Hdi		2.2	100	10.00 - 08.04	DW12TED4	4	☑	Y1005J	7957	56	
C5 2.2 Hdi		2.2	100	02.01 -	DW12TED4	4	☑	Y-504J	1441	24	
C5 2.2 Hdi		2.2	125	05.06 -	DW12BTED4	4	☑	YE08	4966		
C5 3.0 V6		3.0	154	10.00 -	ES9J4S XFX	6	1,1	PLFR5A-11	6240		LPG 7

**C5 3**

C5 III 1.6 Hdi		1.6	80	02.08 -	DV6TED4	4	☑	YE05	91322	73	
C5 III 1.6 Hdi 110		1.6	82	07.10 -	DV6C	4	☑	Y8001AS	8904	58	
C5 III 1.6 Hdi 115		1.6	84	01.12 -	DV6C	4	☑	Y8001AS	8904	58	
C5 III 1.6 120 Vti		1.6	88	07.10 -	EP6C	4	0,8	PLZKBR7A-G	5843		PLZKBR7A-G
C5 III 1.6 155 THP		1.6	115	06.09 -	EP6CDT	4	0,8	PLZKBR7A-G	5843		PLZKBR7A-G
C5 III 1.8		1.8	92	02.08 -	EW7A	4	0,9	LFR5B	7113		LPG 7
C5 III 2.0 Hdi		2.0	100	02.08 -	DW10BTED4	4	☑	Y1005J	7957	56	
C5 III 2.0		2.0	103	02.08 -	EW10A	4	0,9	LFR5B	7113		LPG 7
C5 III 2.0 Hdi 140		2.0	103	04.09 -	DW10BTED4	4	☑	Y1005J	7957	56	
C5 III 2.0 Hdi 165		2.0	120	04.09 -	DW10CTED4	4	☑	Y8001AS	8904	58	
C5 III 2.2 Hdi		2.2	125	02.08 -	DW12BTED4	4	☑	YE08	4966		
C5 III 2.7 V6 Hdi		2.7	150	02.08 -	DT17TED4	6	☑	YE12	7794		
C5 III 3.0 V6		3.0	155	02.08 -	ES9A	6	1,1	PLFR5A-11	6240		LPG 7

**C6**

C6 2.2 Hdi		2.2	125	11.06 -	DW12BTED4	4	☑	YE08	4966		
C6 2.7 V6 Hdi		2.7	150	12.05 -	DT17	6	☑	YE12	7794		
C6 3.0 V6		3.0	155	08.05 -	ES9A / ES9J4S	6	1,1	PLFR5A-11	6240		LPG 7

**C8**

C8 2.0 Hdi 16V		2.0	80	07.02 -	DW10TED4/RHT	4	☑	Y-504J	1441	24	
C8 2.0		2.0	102	06.02 -	EW10J4-RFN	4	0,9	LFR5B	7113		LPG 7
C8 2.0		2.0	104	09.05 -	EW10A	4	0,9	LFR5B	7113		LPG 7
C8 2.0 16V		2.0		09.05 -	EW10A	4	0,9	LFR5B	7113		LPG 7
C8 2.0 Hdi		2.0	100	03.06 -	DW10BTED4	4	☑	Y1005J	7957	56	
C8 2.0 Hdi		2.0	79	04.02 - 08.07	DW10ATED4	4	☑	Y1005J	7957	56	
C8 2.0 Hdi		2.0	80	10.02 - 02.07	DW10UTED4	4	☑	Y1005J	7957	56	

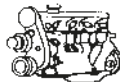
Code *l* kW

Cyl.



Stock-No.

V6/V8

LPG/CNG

**CITROËN****C8**

C8 2.0 Hdi		2.0	81	04.02 -	DW10ATED4	4	☑	Y1005J	7957	56	
C8 2.0 Hdi		2.0	88	03.07 -	DW10UTED4	4	☑	Y1005J	7957	56	
C8 2.0 Hdi 160		2.0	120	04.10 -	DW10CTED4	4	☑	Y8001AS	8904	58	
C8 2.2 Hdi		2.2	94	04.02 - 07.06	DW12TED4	4	☑	Y1005J	7957	56	
C8 2.2 Hdi		2.2	96	02 -	DW12	4	☑	Y-504J	1441	24	
C8 2.2		2.2	118	06.02 -	EW12J4-3FZ	4	0,9	LFR5B	7113		LPG 7
C8 2.2 Hdi		2.2	125	06.06 -	DW12BTED4	4	☑	YE08	4966		
C8 3.0 V6		3.0	150	10.02 -	ES9J4S	6	1,1	PLFR5A-11	6240		LPG 7

**C-CROSSER**

C-Crosser Hdi		2.2	115	06.07 -	DW12MTED4	4	☑	YE08	4966		
C-Crosser		2.4	125	09.07 -	VUSFZC/VUSFZF/ WSFZC/WSFZF	4	0,8	FR5EI	1313		FR6EI

**C-ELYSEE**

C-Elysée 1.2 VTi 72		1.2	52	12 -	EB2M	3	1,0	LZKR6AI-10G	97999		LZKR6AI-10G
C-Elysée 1.6 HDi 92		1.6	68	12 -	DV6DTEd / DV6DTEdM	4	☑	Y8001AS	8904	58	

**DS3**

DS3 1.2 PureTech VTi 82		1.2	60	11 -	EB2	3	1,0	LZKR6AI-10G	97999		LZKR6AI-10G
DS3 1.4 Vti 95		1.4	70	04.10 -	EP3C	4	0,8	PLZKBR7A-G	5843		PLZKBR7A-G
DS3 1.6 Hdi 90		1.6	68	11.09 -	DV6C	4	☑	Y8001AS	8904	58	
DS3 1.6 Hdi 110		1.6	82	11.09 -	DV6CTED4	4	☑	Y8001AS	8904	58	
DS3 1.6 Vti 120		1.6	88	04.10 -	EP6C	4	0,8	PLZKBR7A-G	5843		PLZKBR7A-G
DS3 1.6 THP 155		1.6	115	04.10 -	EP6DT / EP6CDT	4	0,8	PLZKBR7A-G	5843		PLZKBR7A-G

**DS4**

DS4 1.6 e-Hdi 110		1.6	81	04.11 -	DV6C	4	☑	Y8001AS	8904	58	
DS4 1.6 Hdi 110		1.6	82	04.11 -	DV6C	4	☑	Y8001AS	8904	58	
DS4 1.6 Vti 120		1.6	88	04.11 -	EP6C	4	0,8	PLZKBR7A-G	5843		PLZKBR7A-G
DS4 1.6 THP 155		1.6	115	04.11 -	EP6DT / EP6CDT	4	0,8	PLZKBR7A-G	5843		PLZKBR7A-G
DS4 1.6 THP 200		1.6	147	04.11 -	EP6CDTX	4	0,8	ILZKBR7A-8G	5992		ILZKBR7A-8G
DS4 2.0 Hdi 160		2.0	120	04.11 -	DW10CTED4	4	☑	Y8001AS	8904	58	

**DS5**

DS5 1.6 e-Hdi 110		1.6	82	11.11 -	DV6C	4	☑	Y8001AS	8904	58	
DS5 1.6 155 THP		1.6	115	11.11 -	EP6CDT	4	0,8	PLZKBR7A-G			PLZKBR7A-G
DS5 1.6 200 THP		1.6	147	11.11 -	EP6CDTX	4	0,8	ILZKBR7A-8G			ILZKBR7A-8G
DS5 2.0 HDi 165		2.0	120	11.11 -	DW10CTED4	4	☑	Y8001AS	8904	58	
DS5 2.0 HDi 165 Hybrid4		2.0	120	11.11 -	DW10CTED4	4	☑	Y8001AS	8904	58	

**EVASION**

Evasion 1.8		1.8	72	09.96 - 06.00	XU7JP LFW	4		BKR5EK	7956	23	LPG 1
Evasion 1.9 TD		1.9	66	03.94 - 08.98	XUD9TF	4	☑	Y-923U	3380	1	
Evasion 1.9 TD		1.9	68	09.98 - 09.02	XUD9TF, XUD9BTF	4	☑	Y-938R	5267	1	
Evasion 2.0 Hdi		2.0	81	09.98 - 09.02	DW10ATED	4	☑	Y-504J	1441	24	
Evasion 2.0		2.0	89	07.94 - 03.95	XU10J2 RFU	4	0,8	BCPR5ES	6130	32	LPG 3
Evasion 2.0		2.0	90	04.95 - 05.00	XU10J2 RFU	4		BKR5EK	7956	23	LPG 1
Evasion 2.0		2.0	101	06.00 -	EW10J4-RFR	4	0,9	LFR5B	7113		LPG 7
Evasion 2.0 Turbo		2.0	110	09.94 - 05.00	XU10J2TE RGX	4		BKR6EK	2288	20	LPG 1
Evasion 2.1 TD		2.1	80	05.96 - 04.97	XUD11BTE	4	☑	Y-924J	7906	1	
Evasion 2.1 TD		2.1	80	05.97 - 12.98	XUD11BTE	4	☑	Y-924J	7906	1	

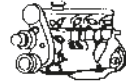
Code *l* kW

Cyl.



Stock-No.



LPG/CNG

**CITROEN  
JUMPER**

Jumper 1.9 D		1.9	52	03.94 - 05.95	XUD9AU	4	☑	Y-923U	3380	1	
Jumper 1.9 D		1.9	52	06.95 -	XUD9AU	4	☑	Y-938R	5267	1	
Jumper 1.9 TD		1.9	68	03.94 - 08.98	XUD9TF	4	☑	Y-923U	3380	1	
Jumper 1.9 TD		1.9	68	09.98 -	XUD9TF	4	☑	Y-938R	5267	1	
Jumper 2.0 Hdi		2.0	66	09.98 -	DW10TD	4	☑	Y-504J	1441	24	
Jumper 2.0		2.0	81	04.95 -	XU10.J2U RFW	4		BKR6EK	2288	20	LPG 1
Jumper 2.2 Hdi		2.2	74	04.02 -	DW12TED	4	☑	Y-504J	1441	24	
Jumper 2.2 Hdi		2.2	76	09.98 -	DW10TED4	4	☑	Y-504J	1441	24	
Jumper 2.2 Hdi		2.2	100	09.98 -	DW12TED4	4	☑	Y-504J	1441	24	
Jumper 2.2 Hdi		2.2	74	02.02 - 06.06	DW12UTED	4	☑	Y1005J	7957	56	
Jumper 2.2 Hdi 100		2.2	74	04.06 -	4HV	4	☑	Y-548J	94832	75	
Jumper 2.2 Hdi 120		2.2	88	04.06 -	4HU	4	☑	Y-548J	94832	75	
Jumper 2.5 D		2.5	63	03.94 -	DJ5	4	☑	Y-923U	3380	1	
Jumper 2.5 TD		2.5	76	03.94 - 08.96	DJ5T	4	☑	Y-923U	3380	1	
Jumper 2.5 Tdi		2.5	78	09.96 -	DJ5TED	4	☑	Y-738U	5390		
Jumper 2.8 Hdi		2.8	93	09.00 - 04.02	4HY	4	☑	Y-502R	3852		
Jumper 3.0 Hdi 145		3.0	107	07.10 -	F30DT	4	☑	Y8005J	96853	64	
Jumper 3.0 Hdi 160		3.0	116	06.09 -	F30DT	4	☑	Y8005J	96853	64	

**JUMPY**

Jumpy 1.6		1.6	59	10.95 -	1580 SPI 220.A2.000	4	0,8	BCPR7ES	3330		BCPR7EIX
Jumpy 1.6 Hdi		1.6	66	02.07 -	DV6UTED4	4	☑	YE05	91322	73	
Jumpy 1.8 D		1.8	51	09.98 -	DW8	4	☑	Y-503R	4279	10	
Jumpy 1.9 D		1.9	51	01.96 - 08.98	XUD9A	4	☑	Y-923U	3380	1	
Jumpy 1.9 D		1.9	51	09.98 -	DW8	4	☑	Y-503R	4279	10	
Jumpy 1.9 D		1.9	51	09.98 -	XUD9A	4	☑	Y-938R	5267	1	
Jumpy 1.9 TD		1.9	68	01.96 - 08.98	XUD9TF/BTF	4	☑	Y-923U	3380	1	
Jumpy 1.9 TD		1.9	68	09.96 -	XUD9TF/BTF	4	☑	Y-938R	5267	1	
Jumpy 2.0 Hdi		2.0	70	02.00 -	DW10TED	4	☑	Y-504J	1441	24	
Jumpy 2.0 Hdi		2.0	70	02.00 -	DW10TED	4	☑	Y-504J	1441	24	
Jumpy 2.0 Hdi 95		2.0	72	07.11 -	DW10CE	4	☑	Y8001AS	8904	58	
Jumpy 2.0 Hdi		2.0	81	02.00 -	DW10ATED	4	☑	Y-504J	1441	24	
Jumpy 2.0 Hdi		2.0	81	02.00 -	DW10ATED	4	☑	Y-504J	1441	24	
Jumpy 2.0 Hdi		2.0	81	05.02 - 10.06	DW10ATED4	4	☑	Y1005J	7957	56	
Jumpy 2.0 Hdi		2.0	88	11.06 -	DW10UTED4	4	☑	Y1005J	7957	56	
Jumpy 2.0 Hdi		2.0	90	02.07 -		4	☑	YE05	91322	73	
Jumpy 2.0 Hdi 125		2.0	94	07.11 -	DW10CD	4	☑	Y8001AS	8904	58	
Jumpy 2.0		2.0	102	06.01 -	EW10J4-RFN	4	0,9	LFR5B	7113		LPG 7
Jumpy 2.0 Hdi		2.0	102	02.07 -		4	☑	YE05	91322	73	
Jumpy 2.0 16V		2.0	105	12.06 -	EW10A	4	0,9	LFR5B	7113		LPG 7
Jumpy 2.0 Hdi		2.0	100	11.06 -	DW10BTED4	4	☑	Y1005J	7957	56	
Jumpy 2.0 Hdi 165		2.0	120	07.10 -	DW10CTED4	4	☑	Y8001AS	8904	58	

**NEMO**

Nemo 1.3 Hdi 75		1.3	55	10.10 -	F13DTE5 (FHZ)	4	☑	Y9001AS	97719	72	
Nemo 1.4		1.4	54	02.08 -	KFV (TU3A)	4	0,9	BKR6EZ	4619		LPG 1
Nemo 1.4 Hdi		1.4	51	02.08 -	DV4TD	4	☑	YE05	91322	73	

**SAXO 1**

Saxo 1 1.0		1.0	37	02.96 - 09.99	TU9M CDZ	4		BKR5EK	7956	23	LPG 1
Saxo 1 1.1		1.1	44	02.96 - 08.99	TU1M+ HDZ	4		BKR6EK	2288	20	LPG 1
Saxo 1 1.4		1.4	55	02.96 - 08.99	TU3JP KFW	4		BKR6EK	2288	20	LPG 1

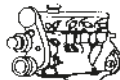

Code *l* kW

Cyl.



Stock-No.

V6/V6E

E5-FORUM/2000

LPG/CNG

**CITROËN****SAXO 1**

Saxo 1 1.4		1.4	55	02.96 - 08.99	TU3JP+ KFX	4		BKR6EK	2288	20	LPG 1
Saxo 1 1.5 D		1.5	43	05.96 - 08.99	TUD 5	4	☑	Y-503J	1009	10	
Saxo 1 1.6		1.6	66	07.98 - 08.99	TU5JP+ NFZ	4		BKR6EK	2288	20	LPG 1

**SAXO 2**

Saxo 2 1.0		1.0	37	09.99 - 12.00	TU9M CDZ	4		BKR5EK	7956	23	LPG 1
Saxo 2 1.1		1.1	44	09.99 -	TU1M+ HDZ	4		BKR6EK	2288	20	LPG 1
Saxo 2 1.1		1.1	44	06.00 -	TU1JP HFX	4	0,9	BKR6EZ	4619	38	LPG 1
Saxo 2 1.1		1.1	44	06.00 -	TU1JP HFX	4	0,9	BKR6EZ	4619	38	LPG 1
Saxo 2 1.4		1.4	55	09.99 -	TU3JP KFW	4	0,9	BKR6EZ	4619	38	LPG 1
Saxo 2 1.4		1.4	55	09.99 -	TU3JP+ KFX	4	0,9	BKR6EZ	4619	38	LPG 1
Saxo 2 1.5 D		1.5	43	09.99 - 05.03	TUD 5	4	☑	Y-503J	1009	10	
Saxo 2 1.6		1.6	66	09.99 - 12.00	TU5JP+ NFZ	4	0,9	BKR6EZ	4619	38	LPG 1
Saxo 2 1.6		1.6	66	01.01 -	TU5JP NFT	4	0,9	BKR6EZ	4619	38	LPG 1
Saxo 2 1.6		1.6	88	03.01 - 04.02	TU5JP NFX	4		BKR6EK	2288	20	LPG 1

**XANTIA**

Xantia 1.6		1.6	66	06.93 - 05.95	XU5JP BFZ	4	0,8	BCPR5ES	6130	32	LPG 3
Xantia 1.6		1.6	66	06.95 -	XU5JP BFZ	4		BKR5EK	7956	23	LPG 1
Xantia 1.8		1.8	66	01.98 -	XU7JB LFX	4		BKR6EK	2288	20	LPG 1
Xantia 1.8		1.8	76	07.93 - 03.95	XU7JP LFZ	4	0,8	BCPR5ES	6130	32	LPG 3
Xantia 1.8		1.8	76	04.95 -	XU7JP LFZ	4		BKR5EK	7956	23	LPG 1
Xantia 1.8 16V		1.8	82	07.95 -	XU7JP4 LFY	4		BKR5EK	7956	23	LPG 1
Xantia 1.9 D		1.9	51	03.93 - 01.96	XUD 9 A/L	4	☑	Y-924J	7906	1	
Xantia 1.9 D		1.9	55	05.94 -	XUD9A	4	☑	Y-938R	5267	1	
Xantia 1.9 D		1.9	55	09.98 -	XUD9A/L	4	☑	Y-938R	5267	1	
Xantia 1.9 TD		1.9	68	06.93 - 08.98	XUD9TF	4	☑	Y-923U	3380	1	
Xantia 1.9 TD		1.9	68	09.98 - 12.00	XUD9BTF, XUD9BSD	4	☑	Y-938R	5267	1	
Xantia 2.0 Hdi		2.0	66	10.98 -	DW10TD	4	☑	Y-504J	1441	24	
Xantia 2.0 Hdi		2.0	81	10.98 - 12.01	DW10ATED	4	☑	Y-504J	1441	24	
Xantia 2.0		2.0	90	03.93 - 05.95	XU10J2 RFX	4	0,8	BCPR5ES	6130	32	LPG 3
Xantia 2.0		2.0	90	06.95 -	XU10J2 RFX	4		BKR5EK	7956	23	LPG 1
Xantia 2.0 16V		2.0	99	06.95 -	XU10J4R RFV	4		BKR5EK	7956	23	LPG 1
Xantia 2.0 CT Turbo		2.0	110	07.96 -	XU10J2TE RGX	4		BKR6EK	2288	20	LPG 1
Xantia 2.0 16V		2.0	112	93 -	XU10J4D	4	0,8	BKR6ES	3783	28	LPG 1
Xantia 2.1 TD		2.1	80	06.95 - 08.98	XUD11BTE	4	☑	Y-923U	3380	1	
Xantia 2.1 TD		2.1	80	09.98 -	XUD11BTF	4	☑	Y-938R	5267	1	
Xantia 3.0 V6		3.0	142	03.97 -	ES9J4 XFZ	6		BKR6EK	2288	20	LPG 1

**XM**

XM 2.0		2.0	99	07.94 - 12.00	XU10J4R RFV	4		BKR5EK	7956	23	LPG 1
XM 2.0 CT Turbo		2.0	110	11.92 - 12.00	XU10J2TE RGX	4		BKR6EK	2288	20	LPG 1
XM 2.0 CT Turbo		2.0	110	96 -	XU10J2CTE	4		BKR6EK	2288	20	LPG 1
XM 2.0		2.0		05.89 - 12.92	XU102C-R2A	4	0,7	BCP6ES	4930	17	LPG 3
XM 2.0		2.0		05.89 - 12.92	XU10J2 R6A	4	0,8	BCPR6ES	2330	12	LPG 3
XM 2.0		2.0		05.92 - 12.00	XU10J2 RFZ Cat.	4	0,8	BCPR5ES	6130	32	LPG 3
XM 2.0 16V		2.0		07.94 -		4	0,8	BCPR6ES	2330	12	LPG 3
XM 2.1 D 12D		2.1	60	05.89 - 06.94	XUD11A/L	4	☑	Y-924J	7906	1	
XM 2.1 D 12TD		2.1	80	05.89 - 08.98	XUD11ATE/L/BTE	4	☑	Y-923U	3380	1	
XM 2.1 D 12TD		2.1	80	09.98 - 12.00	XUD11ATE/L/BTE	4	☑	Y-938R	5267	1	
XM 2.5 TD		2.5	96	07.94 - 12.00	DK5ATE	4	☑	Y-923U	3380	1	
XM 3.0 V6 24V		3.0	140	01.97 - 12.00	ES9J4-XFZ	6		BKR6EK	2288	20	LPG 1
XM 3.0 V6		3.0		05.89 - 06.94	ZPJ-SFZ	6		BCPR6ET	2197		LPG 3

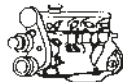
Code *l* kW

Cyl.



Stock-No.



LPG/CNG

**CITROEN  
XM**

XM 3.0 V6		3.0		07.94 - 06.97	ZPJ-UFZ	6		BCPR6ET	2197		LPG 3
XM 3.0 V6 24V		3.0		07.94 - 07.97	ZPJ4-UKZ	6		BCPR7ET	2164		BCPR7EIX

**XSARA**

Xsara 1.4		1.4	55	09.97 - 08.00	TU3JP KFX	4		BKR6EK	2288	20	LPG 1
Xsara 1.5 D		1.5	43	09.97 - 08.00	TUD5	4	☑	Y-503J	1009	10	
Xsara 1.6		1.6	66	09.97 - 08.00	TU5JP NFZ	4		BKR6EK	2288	20	LPG 1
Xsara 1.8 D		1.8	43	10.97 - 09.00	XUD7	4	☑	Y-938R	5267	1	
Xsara 1.8		1.8	66	09.97 - 08.00	XU7JB LFX	4		BKR6EK	2288	20	LPG 1
Xsara 1.8 16V		1.8	75	09.97 - 08.00	XU7JP LFZ	4		BKR5EK	7956	23	LPG 1
Xsara 1.8 16V		1.8	82	09.97 - 08.00	XU7JP4 LFY	4		BKR5EK	7956	23	LPG 1
Xsara 1.9 D		1.9	50	09.97 - 09.00	XUD9A DJY	4	☑	Y-938R	5267	1	
Xsara 1.9 D		1.9	51	06.99 - 08.00	DW8	4	☑	Y-503R	4279	10	
Xsara 1.9 TD		1.9	66	10.97 - 09.00	XUD9TE DHY	4	☑	Y-938R	5267	1	
Xsara 2.0 Hdi		2.0	66	04.99 - 08.00	DW10TD	4	☑	Y-504J	1441	24	
Xsara 2.0 16V		2.0	120	09.97 - 08.00	XU10J4RS RFS	4		BKR6EK	2288	20	LPG 1
Xsara 2 1.4 Hdi		1.4	51	02.03 - 12.04	DV4TD	4	☑	YE04	1684	40	
Xsara 2 1.4 Hdi		1.4	51	12.04 -	DV4TD	4	☑	YE05	91322	73	
Xsara 2 1.4		1.4	55	09.00 -	TU3JP KFW	4	0,9	BKR6EZ	4619	38	LPG 1
Xsara 2 1.5 Hdi		1.5	43	09.00 -	TUD5	4	☑	Y-503J	1009	10	
Xsara 2 1.6 16V		1.6	81	09.00 -	TU5JP4-NFU	4	0,9	LFR6B	6677		LPG 7
Xsara 2 1.8 16V		1.8	86	09.00 -	EW7J4 6FZ	4	0,9	LFR5B	7113		LPG 7
Xsara 2 1.9 D		1.9	52	09.00 -	DW8 WJZ	4	☑	Y-503R	4279	10	
Xsara 2 2.0 Hdi		2.0	66	09.00 - 12.02	DW10TD RHY	4	☑	Y-504J	1441	24	
Xsara 2 2.0 Hdi		2.0	81	05.01 -	DW10ATED RHZ	4	☑	Y-504J	1441	24	
Xsara 2 2.0 16V		2.0	101	09.00 -	EW10J4-RFN	4	0,9	LFR5B	7113		LPG 7
Xsara 2 2.0i 16V VTS		2.0	123	09.00 -	XU10J4RS RFS	4	0,9	BKR5EZ	7642	36	LPG 1
Xsara Picasso 1.6		1.6	66	12.99 -	TU5JP NFZ, NFV	4	0,9	BKR6EZ	4619	38	LPG 1
Xsara Picasso 1.6 Hdi		1.6	66	09.05 -	DV6	4	☑	YE05	91322	73	
Xsara Picasso 1.6 Hdi		1.6	81	05.04 - 06.06	DV6	4	☑	YE04	1684	40	
Xsara Picasso 1.8i 16V		1.8	86	12.99 -	EW7J4-6FZ	4	0,9	LFR5B	7113		LPG 7
Xsara Picasso 2.0 Hdi		2.0	66	01.00 - 07	DW10TD	4	☑	Y-504J	1441	24	
Xsara Picasso 2.0 Hdi		2.0	81	01.00 - 07	DW10TD	4	☑	Y-504J	1441	24	
Xsara Picasso 2.0		2.0	101	09.00 -	EW10J4-RFM	4	0,9	LFR5B	7113		LPG 7

**ZX**

ZX 1.1		1.1	40	03.91 - 06.92	TU1	4	0,8	BCP5ES	7496	16	LPG 3
ZX 1.1		1.1	44	07.92 - 03.96	TU1M HDZ	4	0,8	BCPR5ES	6130	32	LPG 3
ZX 1.1		1.1	44	04.96 -	TU1M	4		BKR5EK	7956	23	LPG 1
ZX 1.1i		1.1	44	04.96 -	TU1M HDZ	4		BKR5EK	7956	23	LPG 1
ZX 1.4		1.4	55	03.91 - 12.92	TU32 K2C	4	0,8	BCP5ES	7496	16	LPG 3
ZX 1.4		1.4	55	03.91 - 06.97	TU3MC KDX	4	0,8	BCPR6ES	2330	12	LPG 3
ZX 1.4		1.4	55	07.92 - 06.97	TU3MC KDY Cat.	4		BKR6EK	2288	20	LPG 1
ZX 1.4		1.4	55	07.97 -	TU3JP KFX	4		BKR6EK	2288	20	LPG 1
ZX 1.4		1.4	55	07.97 -	TU3JP-KFX	4		BKR6EK	2288	20	LPG 1
ZX 1.6		1.6	65	03.91 - 06.93	XU5M BDY Cat.	4	0,8	BCPR5ES	6130	32	LPG 3
ZX 1.6		1.6	66	07.93 - 06.95	XU5JP Cat.	4	0,8	BCPR5ES	6130	32	LPG 3
ZX 1.6i		1.6	66	07.93 - 06.95	XU5JP BFZ	4	0,8	BCPR5ES	6130	32	LPG 3
ZX 1.6		1.6	66	07.95 - 07.98	TU5JP	4		BKR5EK	7956	23	LPG 1
ZX 1.6i		1.6	66	07.95 - 07.98	XU5JP BFZ	4		BKR5EK	7956	23	LPG 1
ZX 1.8 D		1.8	44	03.91 -	XUD 7 A9A	4	☑	Y-924J	7906	1	

Code *l* kW

Cyl.



Stock-No.

V-TIME

LPG/CNG

**CITROEN****ZX**

ZX 1.8 D		1.8	44	03.91 - 04.94	XUD 7 A9A	4	☑	Y-924J	7906	1	
ZX 1.8 D		1.8	44	05.94 - 07.98	XUD7	4	☑	Y-923U	3380	1	
ZX 1.8		1.8	76	07.92 - 06.95	XU7JP LfZ	4	0,8	BCPR5ES	6130	32	LPG 3
ZX 1.8		1.8	76	07.95 -	XU7JP Cat.	4		BKR5EK	7956	23	LPG 1
ZX 1.8i		1.8	76	07.95 -	XU7JP LfZ	4		BKR5EK	7956	23	LPG 1
ZX 1.8		1.8	82	07.97 -	XU7JP4 LfY	4		BKR5EK	7956	23	LPG 1
ZX 1.9 D		1.9	38	05.94 - 07.98	XUD9A/L	4	☑	Y-923U	3380	1	
ZX 1.9 D		1.9	47	03.91 - 04.94	XUD 9 A/L D9B	4	☑	Y-924J	7906	1	
ZX 1.9 TD		1.9	68	09.92 - 04.94	XUD 9 T/L D8A	4	☑	Y-923U	3380	1	
ZX 1.9 TD		1.9	68	05.94 - 07.98	XUD9T/L	4	☑	Y-938R	5267	1	
ZX 1.9		1.9	88	07.92 -	XU9JA DKZ Cat.	4	0,8	BCPR5ES	6130	32	LPG 3
ZX 1.9		1.9	96	03.91 - 06.92	XU9JA D6A	4	0,7	BCP6ES	4930	17	LPG 3
ZX 2.0		2.0	90	07.92 - 03.96	XU10J2C	4	0,8	BCPR5ES	6130	32	LPG 3
ZX 2.0i		2.0	90	07.92 - 03.96	XU10J2 RfX	4	0,8	BCPR5ES	6130	32	LPG 3
ZX 2.0		2.0	90	04.96 -	XU10J2C Cat.	4		BKR5EK	7956	23	LPG 1
ZX 2.0i		2.0	90	04.96 -	XU10J2 RfX	4		BKR5EK	7956	23	LPG 1
ZX 2.0		2.0	110	11.92 - 06.96	XU10J4D RfT Cat.	4		BKR6EK	2288	20	LPG 1
ZX 2.0		2.0	110	07.94 - 06.96	XU10J4D	4	0,8	BCPR6ES	2330	12	LPG 3
ZX 2.0		2.0	110	07.96 -	XU10J4RS-RFS	4	0,9	BKR5EZ	7642	36	LPG 1

**DACIA****DOKKER**

Dokker 1.5 dCi		1.5	55	11.12 -	K9K 612	4	☑	Y1035AS	94103	77	
Dokker 1.5 dCi		1.5	66	11.12 -	K9K 612	4	☑	Y1035AS	94103	77	
Dokker 1.6 16V		1.6	61	11.12 -	K7M 812	4		BKR6EK	2288	20	LPG 1

**DUSTER 2**

Duster 1.5 dCi		1.5	63	04.10 -	K9K 796	4	☑	Y-732J	5605	4	
Duster 1.5 dCi 4x2		1.5	66	10.10 -	K9K 892	4	☑	Y1035AS	94103	77	
Duster 1.5 dCi 4x4		1.5	66	10.10 -	K9K 884	4	☑	Y-732J	5605	4	
Duster 1.5 dCi		1.5	79	06.10 -	K9K 896 / 898	4	☑	Y1035AS	94103	77	
Duster 1.5 dCi		1.5	81	06.10 -	K9K 898	4	☑	Y1035AS	94103	77	
Duster 1.6		1.6	77	03.10 -	K4M 690 / 696	4		BKR6EK	2288	20	LPG 1

**LODGY**

Lodgy 1.5 dCi		1.5	66	03.12 -	K9K 612	4	☑	Y1035AS	94103	77	
Lodgy 1.5 dCi		1.5	79	03.12 -	K9K 846	4	☑	Y1035AS	94103	77	
Lodgy 1.6		1.6	61	03.12 -	K7M 812	4		BKR6EK	2288	20	LPG 1

**LOGAN**

Logan 1.4 MPI		1.4	55	09.04 -	K7J 710	4	0,9	BKR6E	6962	28	LPG 1
Logan 1.5 dCi		1.5	48	09.05 -	K9K 790	4	☑	Y-732J	5605	4	
Logan 1.5 dCi		1.5	50	01.06 -	K9K 792	4	☑	Y-732J	5605	4	
Logan 1.5 dCi		1.5	55	05.10 -	K9K 892	4	☑	Y1035AS	94103	77	
Logan 1.5 dCi		1.5	63	09.07 -	K9K 796	4	☑	Y-732J	5605	4	
Logan 1.6 MPI		1.6	64	09.04 -	K7M 710 engine by renault	4	0,9	BKR6E	6962	28	LPG 1
Logan 1.6 16V		1.6	77	02.06 -	K4MA6	4	0,9	BKR6EZ	4619	38	LPG 1

**SANDERO 1**

Sandero I 1.2 16V		1.2	55	11.08 -	D4F 732	4	0,9	LZKAR7B	5942		
Sandero I 1.2 16V Bifuel		1.2	55	11.08 -	D4F 732	4	0,9	LZKAR7B	5942		
Sandero I 1.4 Mpi		1.4	55	06.08 -	K7J 710	4	0,9	BKR6E	6962	28	LPG 1

Code *l* kW

Cyl.



Stock-No.



LPG/CNG

## DACIA SANDERO 1

Sandero I 1.5 dCi		1.5	50	11.08 -	K9K 792	4		Y-732J	5605	4	
Sandero I 1.5 dCi		1.5	55	05.10 -	K9K 892	4		Y1035AS	94103	77	
Sandero I 1.5 dCi		1.5	63	11.08 -	K9K 796	4		Y-732J	5605	4	
Sandero I 1.5 dCi		1.5	65	05.10 -	K9K 892	4		Y1035AS	94103	77	
Sandero I 1.6 Mpi 85		1.6	62	05.10 -	K7M 800	4		BKR6EK	2288	20	LPG 1
Sandero I 1.6 Mpi		1.6	64	06.08 -	K7M 710	4	0,9	BKR6E	6962	28	LPG 1
Sandero I 1.6 16V Bifuel		1.6	77	01.11 -	K4M 696	4		BKR6EK	2288	20	LPG 1

## DAEWOO ESPERO

Espero		1.5	66	95 - 10.99	A15MF DOHC 16V	4	1,1	BKR6E-11	2756	14	LPG 1
Espero		1.8	66	02.95 - 10.99	C18LE	4	0,8	BPR6ES	7822	2	LPG 2
Espero		2.0	77	02.95 - 10.99	C20LE	4	0,8	BPR6ES	7822	2	LPG 2

## EVANDA

Evanda		2.0	96	03 - 02.05	T20SED	4		BKR5EK	7956	23	LPG 1
--------	--	-----	----	------------	--------	---	--	--------	------	----	-------

## KALOS

Kalos 1.2 SE		1.2	53	04.03 - 02.05	B12S1	4	1,1	BPR5EY-11	3028		LPG 2
Kalos 1.4 SE S100		1.4	61	09.02 - 02.05	F14S3	4	0,8	BPR6ES	7822	2	LPG 2
Kalos 1.4 SE		1.4	61	04.03 - 02.05	F14S3 SOHC	4	0,8	BPR6ES	7822	2	LPG 2
Kalos 1.4 SX		1.4	69	04.03 - 02.05	F14D3 DOHC	4	1,1	BKR6E-11	2756	14	LPG 1

## KORANDO

Korando TD		2.3	74	04.00 -		4		Y-916J	5906	6	
Korando TD, Cabriolet		2.9	88	04.00 -		5		Y-916J	5906	6	
Korando		2.9		04.00 -		4		Y-916J	5906	6	

## LACETTI

Lacetti 1.4		1.4	68	09.03 - 02.05	F14D3	4	1,1	BKR6E-11	2756	14	LPG 1
Lacetti 1.6		1.6	80	09.03 - 02.05	F16D3	4	1,1	BKR6E-11	2756	14	LPG 1
Lacetti 1.8		1.8	90	09.03 - 02.05	T18SED	4		BKR5EK	7956	23	LPG 1

## LANOS

Lanos 1.4		1.4	55	05.97 - 02.05	A14SMS SOHC	4	0,8	BPR6ES	7822	2	LPG 2
Lanos 1.5		1.5	63	05.97 - 02.05	A15SMS SOHC	4	0,8	BPR6ES	7822	2	LPG 2
Lanos 1.6		1.6	78	05.97 - 02.05	A16DMS DOHC	4	1,1	BKR6E-11	2756	14	LPG 1

## LEGANZA

Leganza 2.0		2.0	100	07.97 - 12.02	X20SED DOHC	4		BKR5EK	7956	23	LPG 1
Leganza 2.2		2.2		07.97 - 12.02	T22SED DOHC	4		BKR6EK	2288	20	LPG 1

## MATIZ

Matiz 0.8		0.8	38	06.98 - 02.05	F8CV	3	1,1	BCPR5EY-11	4120		LPG 3
Matiz 1.0		1.0	47	03.03 - 02.05	B10S	4	1,1	BCPR5EY-11	4120		LPG 3

## MUSSO

Musso 2.0		2.0	100	09.96 -	M 161.940	4	0,8	BCP5ES	7496	16	LPG 3
Musso 2.3 SLTD		2.3	74	04.00 -		4		Y-916J	5906	6	
Musso 2.3 16V		2.3	110	11.96 -	M 161.970	4	0,8	BCP5ES	7496	16	LPG 3
Musso 2.9 SELTD		2.9	88	04.00 -		5		Y-916J	5906	6	
Musso 2.9		2.9		04.00 -		4		Y-916J	5906	6	
Musso 3.2 E32		3.2	162	05.96 -	Mercedes M162990	6	0,8	BCP5ES	7496	16	LPG 3



Code *l* kW

Cyl.



Stock-No.

V-TUNE

LPG/CNG

**DAEWOO****NEW BROUGHAM**

New Brougham		2.0	85	01.96 - 02.97	SOHC	4	1,1	BPR5ES-11	4424		LPG 2
New Brougham		2.0	106	01.96 - 02.97	DOHC 16V	4		BKR5EK	7956	23	LPG 1
New Brougham		2.2	110	01.96 - 02.97	DOHC 16V	4		BKR5EK	7956	23	LPG 1

**NEW PRINCE**

New Prince		1.8	81	04.96 - 02.97	SOHC	4	1,1	BPR5ES-11	4424		LPG 2
New Prince		1.8	101	04.96 - 02.97	DOHC 16V	4		BKR5EK	7956	23	LPG 1
New Prince		2.0	85	04.96 - 02.97	SOHC	4	1,1	BPR5ES-11	4424		LPG 2
New Prince		2.0	106	04.96 - 02.97	DOHC 16V	4		BKR5EK	7956	23	LPG 1

**NEXIA**

Nexia 1.5		1.5	55	02.95 -	OHC	4	0,8	BPR6ES	7822	2	LPG 2
Nexia 1.5		1.5	66	02.95 -	DOHC 16V	4	1,1	BKR6E-11	2756	14	LPG 1
Nexia 1.8		1.8	74	12.95 - 10.96	C18LE SOHC	4	0,8	BPR6ES	7822	2	LPG 2

**NUBIRA**

Nubira 1.6		1.6	80	07.97 - 02.05	A16DMS DOHC	4	1,1	BKR6E-11	2756	14	LPG 1
Nubira 1.8 CDX		1.8	90	03 - 02.05	T18SED	4		BKR5EK	7956	23	LPG 1
Nubira 2.0		2.0	99	07.97 - 02.05	X20SED DOHC	4		BKR5EK	7956	23	LPG 1

**REZZO / TACUMA U100**

Rezzo / Tacuma U100		1.6	77	01 - 02.05	A16DMS	4	1,1	BKR5E-11	6953	33	LPG 1
Rezzo / Tacuma U100		2.0	89	01 - 02.05	T20SED	4		BKR5EK	7956	23	LPG 1

**TACUMA**

Tacuma 1.6		1.6		01 -	L4 DOHC	4	1,1	BKR6E-11	2756	14	LPG 1
Tacuma 1.8		1.8		01 -	L4 SOHC	4	0,9	BPR5ES	7422	6	LPG 2
Tacuma 2.0		2.0		01 -	L4 DOHC	4		BKR5EK	7956	23	LPG 1

**DAF**

400 Serie D		2.5	53	04.89 - 08.93		4		Y-922R	4356	1	
400 Serie TD		2.5	71	04.89 - 08.93		4		Y-922R	4356	1	

**DAIHATSU****CHARADE CL10,60**

Charade CL10,60		1.0	27	86 -	CL	4		Y-703R	3782		
Charade G10		1.0	38	81 -	CB20	3	0,8	BPR5EA-L	5823		LPG 2
Charade G11		1.0	38	83 -	CB22	3	0,8	BPR5EA-L	5823		LPG 2
Charade GTi G100		1.0	74	03.87 -	CB80	3	0,8	BPR6EKN	1128		
Charade CL50		1.0		86 -	CL	4		Y-703R	3782		
Charade G102		1.3	66	07.91 -	HC-E	4	1,1	BKR6E-11	2756	14	LPG 1
Charade G112 4WD		1.3	66	02.97 -	HC-E	4	1,1	BKR6E-11	2756	14	LPG 1

**COPEN L880K**

Copen L880K		0.66	50	09.03 -	JB-DET	4	1,1	IFR6J11	7658		IFR6J11
Copen L881		1.3	64	10.05 -	K3-VE	4	1,1	BKR6EY-11	4368		LPG 1

**CUORE**

Cuore L55		0.54	21		AB30	3	0,8	BPR6ES	7822	2	LPG 2
Cuore L60		0.61	22		AD10	3	0,8	BPR6ES	7822	2	LPG 2
Cuore L201		0.85	30		ED10	3	0,8	BPR6EY	6427		LPG 2
Cuore L80		0.85	32		ED10	3	0,8	BPR6EY	6427		LPG 2
Cuore L501		0.85	32	05.95 - 04.96	ED20	3	0,8	BPR6EY	6427		LPG 2
Cuore L501		0.85	32	05.96 -	ED20	3	1,1	BPR5EY-11	3028		LPG 2
Cuore L701		1.0	40	06.98 - 01	EJ-DE	3	1,1	BKR5E-11	6953	33	LPG 1

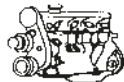
Code *l* kW

Cyl.



Stock-No.



LPG/CNG

**DAIHATSU  
CUORE**

Cuore L701		1.0	43	07.01 -	EJ-VE	3		BKR5EKC	5216		LPG 1
Cuore L251		1.0	43	05.03 -	EJ-VE	3		BKR5EKC	5216		LPG 1
Cuore 1.0 Top L276		1.0	52	09.07 -	1KR-FE	3	1,1	ILFR6T11	4904		ILFR6T11

**ESSE**

Esse L235S		0.66		12.05 -	KF-VE	3	0,9	LKR7C	4472		LKR7C
Esse L245S		0.66		12.05 -	KF-VE	3	0,9	LKR7C	4472		LKR7C

**GRAN MOVE**

Gran Move L901		1.0	40	10.99 -	EJ-DE	3		BKUR6EK	2213		
Gran Move G303		1.5	66	04.97 -	HE-EG	4	1,1	BKR6E-11	2756	14	LPG 1
Gran Move G301		1.6	67	07.99 -	HD-EP	4	1,1	BKR6E-11	2756	14	LPG 1

**HIJET**

Hijet		1.0		86 -	CB42	3	0,8	BPR5EY	2828	9	LPG 2
Hijet		1.3	48	08.98 -	HC-ES	4		BKUR6EK	2213		

**MATERIA**

Materia 1.3		1.3	67	12.06 -	K3-VE	4		IKR7D	4759		IKR7D
Materia 1.5		1.5	76	12.06 -	3SZ-VE	4		IKR7D	4759		IKR7D

**MIRA**

Mira L235S		0.66		12.05 -	KF-VE	3	0,9	LKR7C	4472		LKR7C
Mira L245S		0.66		12.05 -	KF-VE	3	0,9	LKR7C	4472		LKR7C
Mira		0.85		01.93 - 97	ED10 (K)	3	0,9	BPR6EY	6427		LPG 2

**MOVE**

Move L235S		0.66		12.05 -	KF-VE	3	0,9	LKR7C	4472		LKR7C
Move L245S		0.66		12.05 -	KF-VE	3	0,9	LKR7C	4472		LKR7C
Move L601		0.85	31	97 - 10.00	ED20	3	1,1	BPR5EY-11	3028		LPG 2
Move L901		1.0	40	10.99 - 09.02	EJ-DE	3		BKUR6EK	2213		

**ROCKY**

Rocky F80		2.0	65	04.84 - 04.93	3Y	4	0,8	BP5EY	7327		LPG 2
Rocky F85		2.0	65	04.84 - 04.93	3Y	4	0,8	BP5EY	7327		LPG 2
Rocky		2.8	67	12.87 - 04.93	DL51	4		Y-146R	7492		
Rocky TD		2.8	67	12.87 - 04.93	DL 51	4		Y-146R	7492		
Rocky TD		2.8	72	05.93 -	DL 52	4		Y-146R	7492		
Rocky TD		2.8	75	09.91 -	DL 52	4		Y-146R	7492		

**SIRION 1**

Sirion 1 1.0	M100 / M110	1.0	40	06.98 - 00	EJ-DE	3		BKUR6EK	2213		
Sirion 1 1.0	M100 / M110	1.0	43	05.00 - 04	EJ-VE	3		BKR5EKC	5216		LPG 1
Sirion 1 1.3	M101 / M111	1.3	75	09.01 - 04	K3-VE2	4		BKUR6ETB-10	5742		

**SIRION 2**

Sirion 2 1.0	M300	1.0	51	01.05 -	1KR-FE	3	1,1	ILFR6T11	4904		ILFR6T11
Sirion 2 1.3	M301 / M311	1.3	64	07.07 -	K3-VE	4	0,9	DCPR7EA-9	6651		
Sirion 2 1.3	M301 / M311	1.3	64	01.05 - 06.07	K3-VE	4	1,1	BKR6EY-11	4368		LPG 1
Sirion 2 1.3	M301 / M311	1.3	67	03.08 -	K3-VE	4	0,9	DCPR7EA-9	6651		
Sirion 2 1.5	M303	1.5	76	03.08 -	3SZ-VE		0,9	DCPR7EA-9	6651		

**TERIOS 1**

Terios 1 1.3	J100	1.3	61	09.97 - 00	HC-EJ Aluengien	4		BKUR6EK	2213		
Terios 1 1.3	J102	1.3	63	05.00 - 12.05	K3-VE	4		BKUR6ETB-10	5742		

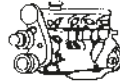
Code *l* kW

Cyl.



Stock-No.

VEFINE

LPG/CNG

**DAIHATSU****TERIOS 2**

Terios 2 1.3	J211	1.3	63	11.05 -	K3-VE	4	1,1	BKR6EY-11	4368		LPG 1
Terios 2 1.5	J200 / J210	1.5	77	01.06 - 12.07	3SZ-VE	4		IKR7D	4759		IKR7D
Terios 2 1.5	J200 / J210	1.5	77	01.08 -	3SZ-VE	4	0,9	DCPR7EA-9	6651		

**TREVIS**

Trevis automatic		1.0	43	09.06 -	EJ-VE	4		BKR6EKC	2848	26	LPG 1
Trevis Schaltgetriebe / gearbox		1.0	43	09.06 -	EJ-VE	4		BKUR6EK	2213		

**YRV**

YRV 1.0	M200	1.0	43	08.00 - 07.05	EJ-VE	4		BKR5EKC	5216		LPG 1
YRV 1.3	M201 / M211	1.3	64	01.01 - 07.05	K3-VE	4		BKUR6ETB-10	5742		
YRV 1.3 GTti	M201	1.3	95	07.02 - 07.05	K3-VT	4	0,8	BKR6EP-8	2215		LPG 1

**DAIMLER**

4.0 Litre		4.0	164	09.89 - 09.94	AJ6	6	0,8	BCPR6ES	2330	12	LPG 3
4.0 Super V8		4.0		09.97 - 03.00		8	1,3	PFR6G-13E	2341		
4.0 Super V8		4.0		03.00 - 03.02		8	1,1	PFR5G-11E	3000		
4.0 Super V8		4.0		03.02 -		8	1,0	IFR5N10	7866		
4.0 V8		4.0		09.97 - 09.98		8	1,3	BKR5EVXA-13	1188		
4.0 V8		4.0		09.98 - 03.00		8	1,3	PFR5G-13E	2761		
4.0 V8		4.0		03.00 - 03.02		8	1,1	PFR5G-11E	3000		
4.0 V8		4.0		03.02 -		8	1,0	IFR5N10	7866		
Century 4.0		4.0	180	10.95 - 09.96	AJ6	6	0,8	BCPR6ES	2330	12	LPG 3
Century 6.0		6.0		10.95 - 09.96	HE	12	0,6	BR6EF	3177		
Double Six				86 - 09.91	HE	12	0,6	BR7EFS	1094		
Double Six				10.91 - 93	HE	12	0,6	BR7EF	3346		
Double Six		5.3		90 -	V12 HE	12	0,6	BR7EFS	1094		
Double Six		6.0		02.93 - 09.94	HE	12	0,6	BR7EFS	1094		
Double Six 6.0		6.0		93 -	HE	12	0,6	BR7EF	3346		
Double six		6.0		09.94 - 09.97	HE	12	0,6	BR6EF	3177		
Six 4.0		4.0		09.94 - 09.97	AJ6	6	0,8	BCPR6ES	2330	12	LPG 3
Sovereign 4.0		4.0		89 -			0,8	BCPR6ES	2330	12	LPG 3
4.0 Super V8		4.0	267	09.97 - 03.00	V8	8	1,3	PFR6G-13E	2341		
4.0 V8		4.0		09.97 - 09.98	AJ26	8	1,3	BKR5EVXA-13	1188		
4.0 V8		4.0		09.98 - 03.00	AJ26	8	1,3	PFR5G-13E	2761		
4.0 Super V8		4.0		03.00 - 03.02	AJ26	8	1,1	PFR5G-11E	3000		
4.0 V8		4.0		03.00 - 03.02	AJ26	8	1,1	PFR5G-11E	3000		
4.2 Super V8		4.2		03.02 -	AJ26	8	1,0	IFR5N10	7866		
4.2 V8		4.2		03.02 -	AJ26	8	1,0	IFR5N10	7866		

**DODGE****AVENGER**

Avenger 2.0		2.0	115	06.07 -		6	1,1	PZFR5F-11	4363		LPG 6
Avenger 2.0		2.0		95 - 99	L4 MPI Y DOHC	4	1,1	BKR6EVX-11	3540		LPG 1
Avenger 2.5		2.5		95 -	V6 MPI N DOHC	6	1,1	PFR5G-11	2647		PFR6G-11
Avenger 2.7		2.7	138	06.07 -	V6	6	1,3	LZTR5A-13	4612		

**CALIBER**

Caliber 1.8		1.8	110	06 -		4	1,1	ZFR5F-11	2262		LPG 6
Caliber 2.0		2.0	115	06 -		4	1,1	ZFR5F-11	2262		LPG 6
Caliber 2.4		2.4	125	06 -		4	1,1	ZFR5F-11	2262		LPG 6

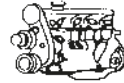
Code *ℓ* kW

Cyl.



Stock-No.



LPG/CNG

**DODGE CHARGER**

Charger SRT8 Twinspark		6.1		06 -	W V8 FI	8	1,3	LZTR5A-13	4612		
------------------------	--	-----	--	------	---------	---	-----	-----------	------	--	--

**COLT**

Colt 1.5		1.5		93 - 94	L4 MPI A	4	1,1	BPR5EIX-11	2115		LPG 2
Colt 1.8		1.8		92 - 94	L4 MPI C	4	1,1	BKR5EVX-11	5182		LPG 1
Colt 2.4		2.4		92 - 92	L4 MPI W	4	1,1	BPR5EIX-11	2115		LPG 2
Colt 2.4		2.4		93 - 94	L4 MPI G	4	1,1	BKR6EVX-11	3540		LPG 1

**INTREPID**

Intrepid 2.7		2.7		98 -	V6 MPI R DOHC	6	1,3	LZTR5A-13	4612		
Intrepid 3.3		3.3		93 - 97	V6 MPI T	6	1,2	GR45	2822		GR5IX
Intrepid 3.3		3.3		94 - 95	V6 FF U	6	1,2	GR45	2822		GR5IX
Intrepid 3.5		3.5		93 - 97	V6 MPI F	6	0,9	FR5-1	7252		

**MAGNUM**

Magnum SRT8		6.1		06 -	W V8 FI	8	1,3	LZTR5A-13	4612		
-------------	--	-----	--	------	---------	---	-----	-----------	------	--	--

**NEON**

Neon 2.0		2.0		95 - 99	L4 MPI Y DOHC	4	0,8	BKR6ES	3783	28	LPG 1
Neon 2.0		2.0		02 -	L4 MPI C SOHC	4	0,8	BKR6ES	3783	28	LPG 1

**R1500-3500**

R1500-3500		3.9		94 - 96	MPI X	6	0,9	FR4	5188		
R1500-3500		3.9		97 - 99	MPI X	6	1,1	FR5-1	7252		
R1500-3500		5.2		94 - 96	MPI Y	8	0,9	FR4	5188		
R1500-3500		5.2		95 - 96	CNG T	8	0,9	FR4	5188		
R1500-3500		5.2		97 - 99	CNG T	8	1,1	FR5-1	7252		
R1500-3500		5.2		97 - 99	MPI Y	8	1,1	FR5-1	7252		
R1500-3500		5.9		94 - 97	MPI Z	8	0,9	FR4	5188		
R1500-3500		5.9		94 - 95	TBI 5	8	1,1	WR5	2438		WR5IX
R1500-3500		5.9		97 - 97	MPI 5	8	0,9	FR4	5188		
R1500-3500		5.9		98 - 99	MPI 5	8	1,1	FR5-1	7252		
R1500-3500		5.9		98 - 99	MPI Z	8	1,1	FR5-1	7252		
R1500-3500		8.0		94 - 96	MPI W	10	1,1	PZFR5F-11	4363		LPG 6
R1500-3500		8.0		97 - 99	MPI W	10	1,1	PZFR5F-11	4363		LPG 6

**STEALTH**

Stealth		3.0		91 - 92	V6 MPI B DOHC	6	1,1	PFR6J-11	2743		PFR6J
Stealth Turbo		3.0		91 - 92	V6 MPI C DOHC	6	1,1	PFR6J-11	2743		PFR6J
Stealth		3.0		93 - 96	V6 MPI H SOHC	6	1,1	BPR5EIX-11	2115		LPG 2
Stealth		3.0		93 - 96	V6 MPI J DOHC	6	1,1	PFR6J-11	2743		PFR6J
Stealth Turbo		3.0		93 - 96	V6 MPI K DOHC	6	1,1	PFR6J-11	2743		PFR6J

**STRATUS**

Stratus 2.0		2.0		95 -	L4 MPI C SOHC	4	0,9	FR5	4876		
Stratus 2.4		2.4		95 - 00	L4 MPI X DOHC	4	1,1	FR45	4636		
Stratus 2.4		2.4		01 - 03	L4 FI X,G DOHC/TURBO	4	1,3	LZTR5A-13	4612		
Stratus 2.4		2.4		04 -	L4 FI X,G	4	1,1	LZTR4A-11	5444		
Stratus 2.5		2.5		95 -	V6 MPI H DOHC	6	1,1	PFR5G-11	2647		PFR6G-11

**VIPER**

Viper 8.0		8.0		92 - 02	E V10 MPI	10	0,9	FR5-1	7252		
Viper 8.3		8.3		03 - 03	Z V10	10	0,8	ZFR5N	3459		
Viper 8.3		8.3		04 - 06	Z V10	10	1,1	PZFR6F-11	3271		LPG 6

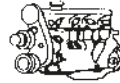

Code *l* kW

Cyl.



Stock-No.

VETINE

E-FORUM

LPG/CNG

**FERRARI**

575 M Maranello / F1		5.7	379	02.02 - 06.06	F133E	12	0,7	DCPR9EVX	6436		
599 GTB FIORANO		6.0	456	05.06 -	F140C	12		PMR8B	6378		PMR9B
612 Scaglietti		5.7	397	09.04 -	F133F	12	0,7	DCPR9EVX	6436		
Challenge Stradale		3.6	313	01.04 -	F131B	8		PMR8B	6378		PMR9B
Enzo		6.0	485	02 -	F140B	12		PMR8B	6378		PMR9B
F348 TB; TS		3.4	221	09.89 - 04.94	F119D040 Cat.	8	0,6	D8EVX	2850		
348 GTB; GTS		3.4	221	04.90 - 03.93	F119F	8	0,7	DCPR9EVX	6436		
348 GTB; GTS		3.4	236	03.93 - 06.94	F119H	8	0,7	DCPR9EVX	6436		
F348 GTB; GTS / Spider		3.9	221	07.94 - 07.95	F119	8	0,7	DCPR9EVX	6436		
F355		3.5	280	05.94 - 01.96	F129C	8	0,7	PMR8A	5851		PMR8A
F355 Berlinetta		3.5	280	07.94 -		8	0,6	CR8EVX	6487		
F355GTS		3.5	280	05.94 - 01.96	F129B	8	0,7	PMR8A	5851		PMR8A
F355 Spider		3.5	280	07.95 -		8	0,7	PMR7A	4259		PMR8A
F355GTS		3.5	280	02.96 -	F129C	8	0,7	PMR7A	4259		PMR8A
F355 F1 berlinetta; GTS; Spider		3.5	280	11.97 -	F129C	8	0,7	PMR7A	4259		PMR8A
Modena 360 - 360 F1		3.6	294	05.99 - 11.03	F131B	8	0,7	PMR8A	5851		PMR8A
360 Spider / F1		3.6	294	09.00 - 11.03	F131B	8	0,7	PMR8A	5851		PMR8A
360 Spider / F1		3.6	294	12.03 -	F131B	8		PMR8B	6378		PMR9B
Coupè 360 Modena/F1		3.6	294	12.03 -	F131B	8		PMR8B	6378		PMR9B
F40		2.9	353	01.88 - 05.92	F120A	8	0,5	C8E	7471		
F430 Coupé / F430 Spider / F430 Challenge		4.3	360	01.05 -	F136E	8		PMR8B	6378		PMR9B
430 Scuderia		4.3	375	08 -	F136ED	8		PMR8B	6378		PMR9B
F456 GT		5.5	324	02.96 - 04.98	F116C	12	0,7	DCPR9EVX	6436		
F456 GTA		5.5	324	07.96 - 04.98	F116C.010	12	0,7	DCPR9EVX	6436		
456 M GTA		5.5	325	05.98 -	F116C.010	12	0,7	DCPR9EVX	6436		
465 M GT		5.5	325	05.98 -	F116C	12	0,7	DCPR9EVX	6436		
F50		4.7	361	05.95 -	F130B	12	0,7	PMR7A	4259		PMR8A
512 TR		5.0	316	02.91 - 10.96	F113D	12	0,7	DCPR9EVX	6436		
Mondial T/ T Cabriolet		3.4	221	11.88 - 02.94	F119DL Cat	8	0,6	D8EVX	2850		
Testarossa		4.9	272	10.84 - 10.91	F113B000 Cat.	12	0,6	D8EVX	2850		
F456 GT		5.5	324	04.93 - 01.96	F116B	12	0,7	DCPR9EVX	6436		
F550 Maranello		5.5	357	08.96 -	F133A	12	0,7	DCPR9EVX	6436		

**FIAT****126**

126 (650)		0.65	22	01.83 - 06.96	141A000		0,8	BPR6ES	7822	2	LPG 2
126 BIS		0.7	19	09.87 - 06.91	126A2000	2	0,8	BPR6ES	7822	2	LPG 2

**500**

500 0.9 Twin Air	312	0.9	63	07.10 -	312A2000	2	0,8	ILKR9G8	97168		ILKR9G8
500 1.2	312	1.2	51	07.07 -	169A4000	4	1,0	ZKR7A-10	1691		LPG 8
500 1.2 Easypower LPG Euro V	312	1.2	51	01.09 -	169A4000	4	0,8	ZKR7AI-8	92402		ZKR7AI-8
500 1.3 D Mjet	312	1.3	56	07.07 -	169A1000	4		Y8003J	97256	62	
500 1.3 D Mjet	312	1.3	70	11.09 -	199B1000	4		Y9001AS	97719	72	
500 1.4 16V	312	1.4	74	07.07 -	169A3000	4	1,0	DCPR7E-N-10	4983		LPG 8
500 1.4 Abarth	312	1.4	99	08.08 -	312A1000	4	0,8	IKR9J8	93311		IKR9J8
500 1.4 Abarth	312	1.4	102	05.08 -	198A1000	4	0,8	IKR9J8	93311		IKR9J8
500 1.4 Abarth	312	1.4	132	08.08 -	312A3000	4	0,8	IKR9J8	93311		IKR9J8
500 1.4 Abarth	312	1.4	140	08.08 -	312A1000	4	0,8	IKR9J8	93311		IKR9J8

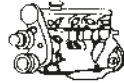
Code *l* kW

Cyl.



Stock-No.



LPG/CNG

**FIAT****500 L**

500 L 0.9		0.9	77	09.12 -	199B6000	2	0,8	ILKR9G8	97168		ILKR9G8
500 L 1.3 JTD		1.3	62	09.12 -	199B4000	4		Y9001AS	97719	72	
500 L 1.4		1.4	70	09.12 -	843A1000	4	0,9	DCPR7E-N	4795		LPG 8

**BARCETTA**

Barchetta	183	1.8	96	04.95 - 07.00	183A1000	4		BKR6EKC	2848	26	LPG 1
Barchetta	183	1.8	96	08.00 -	183A1000	4	0,9	BKR6EZ	4619	38	LPG 1

**BRAVA**

Brava i.,80 16V Sx,Hsx	182	1.2	59	03.98 - 05.99	182B2000	4		DCPR8EKC	7168		LPG 8
Brava ;80 16V; Trofeo,Steel Sx,Hsx	182	1.2	59	06.99 - 05.01	182B2000	4	0,9	DCPR8E-N	5692		LPG 8
Brava i. 12V	182	1.4	55	10.95 - 02.98	182A5000	4		BKR6EKC	2848	26	LPG 1
Brava - 12V- S,SX	182	1.4	59	10.95 - 05.01	182A3000	4		BKR6EKC	2848	26	LPG 1
Brava 16V	182	1.6	66	10.95 - 05.01	182A6000	4		BKR6EKC	2848	26	LPG 1
Brava i. 16V EL; aut. EL; ELX	182	1.6	76	10.95 - 06.96	182A4000	4		BKR6EKC	2848	26	LPG 1
Brava i.,100 16V;Aut. Sx,Hsx,Elx	182	1.6	76	05.98 - 06.99	182A4000	4		BKR6EKC	2848	26	LPG 1
Brava 100 16V Sx,Hsx,Elx;Aut.	182	1.6	76	07.99 - 05.01	182A4000	4	0,9	BKR5EZ	7642	36	LPG 1
Brava 16V	182	1.8	83	10.95 - 05.01	182A2000	4		BKR6EKC	2848	26	LPG 1
Brava / o D	182	1.9	55	09.95 - 10.96	160A7000	4		Y-920R	3645	1	
Brava / o D; TD	182	1.9	55	04.96 - 11.99		4		Y-928U	4389	29	
Brava / o 1.9 JTD	182	1.9	74	09.00 - 10.01	182B9000	4		Y-534J	3413	36	
Brava / o 1,9 JTD	182	1.9	77	12.98 - 11.99	182B4000 fino a n. motore —>1716458	4		Y-747U	4694	26	
Brava / o 1,9 JTD	182	1.9	77	12.99 - 09.00	182B4000 dal n. motore 1716450 —>	4		Y-534J	3413	36	
Brava / o D	182	2.0	74	09.95 - 07.96		4		Y-923U	3380	1	

**BRAVO 1**

Bravo 1 i.,80 16V Sx;Trofeo;Steel	182	1.2	59	03.98 - 05.99	182B2000	4		DCPR8EKC	7168		LPG 8
Bravo 1 80 16V Sx Trofeo; Steel	182	1.2	59	06.99 - 05.01	182B2000	4	0,9	DCPR8E-N	5692		LPG 8
Bravo 1 i. 12V	182	1.4	55	10.95 - 02.98	182A5000	4		BKR6EKC	2848	26	LPG 1
Bravo 1 1.4i 12V S	182	1.4	59	03.98 - 05.01	182A3000	4		BKR6EKC	2848	26	LPG 1
Bravo 1 i. 16V	182	1.6	66	10.95 - 05.01	182A6000	4		BKR6EKC	2848	26	LPG 1
Bravo 1 100 16V EL;Aut.	182	1.6	76	10.95 - 06.01	182A4000	4		BKR6EKC	2848	26	LPG 1
Bravo 1 100 16V El,Sx,GT,Steel; Aut.	182	1.6	76	07.99 - 05.01	182A4000	4	0,9	BKR5EZ	7642	36	LPG 1
Bravo 1 1.8L - 16V GT	182	1.8	83	03.95 - 05.01	182A2000	4		BKR6EKC	2848	26	LPG 1
Bravo 1 i. 20V, 155 HGT	182	2.0	108	10.95 - 05.01	182A1000	5		BKR6EKC	2848	26	LPG 1
Bravo 1 155 20V	182	2.0	113	12.99 - 05.01	182A1000	4		BKR6EKC	2848	26	LPG 1

**BRAVO 2**

Bravo 2 1.4 16V	198	1.4	66	01.07 -	192B2000	4	1,0	DCPR7E-N-10	4983		LPG 8
Bravo 2 1.4 T-Jet	198	1.4	88	09.07 -	198A4000	4	0,8	IKR9J8	93311		IKR9J8
Bravo 2 1.4 T-Jet	198	1.4	103	03.08 -	198A7000	4	0,8	IKR9J8	93311		IKR9J8
Bravo 2 1.4 T-Jet	198	1.4	110	04.07 -	198A1000	4	0,8	IKR9J8	93311		IKR9J8
Bravo 1.6 D Mjet	198	1.6	66	03.08 -	198A3000	4		Y9003AS	94251	78	
Bravo 1.6 D Mjet	198	1.6	77	03.08 -	198A3000	4		Y9003AS	94251	78	
Bravo 1.6 D Mjet	198	1.6	85	11.08 -	955A4000	4		Y9003AS	94251	78	
Bravo 1.6 D Mjet	198	1.6	88	03.08 -	198A2000	4		Y9003AS	94251	78	
Bravo 2 1.9 D Mjet	198	1.9	66	04.07 - 12.08	192B5000	4		Y1030J	90828	70	
Bravo 2 1.9 D Mjet	198	1.9	85	04.07 - 06.08	192B4000 / 192A1000	4		Y1030J	90828	70	
Bravo 2 1.9 D Mjet	198	1.9	88	04.07 -	192A8000	4		Y1030J	90828	70	
Bravo 2 1.9 D Mjet	198	1.9	110	01.07 -	937A5000	4		YE07	6092		
Bravo 2.0 D Mjet	198	2.0	120	09.08 -	844A2000	4		Y9003AS	94251	78	

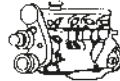
Code *l* kW

Cyl.



Stock-No.



LPG/CNG

**FIAT****BRAVO 2**

Bravo 2.0 D Mjet	198	2.0	121	09.08 -	198A5000	4		Y9003AS	94251	78	
------------------	-----	-----	-----	---------	----------	---	--	---------	-------	----	--

**CINQUECENTO**

Cinquecento 700 ED	170	0.7	23	07.91 - 02.97	170A000	2	0,8	BPR6ES	7822	2	LPG 2
Cinquecento 900	170	0.9	29	02.95 - 05.98	1170 A1046	4	0,8	BPR6ES	7822	2	LPG 2
Cinquecento i S,SX,SUITE	170	0.9	29	07.95 - 12.99		4	0,8	BPR6ES	7822	2	LPG 2
Cinquecento 900 -Van	170	0.9	29	04.96 - 05.98	1170.1046	4	0,8	BPR6ES	7822	2	LPG 2
Cinquecento	170	0.9	30	92 - 05.98	170A1000	4	0,8	BPR6ES	7822	2	LPG 2
Cinquecento 900	170	0.9	30	92 - 05.98	170A1046 Cat.	4	0,8	BPR6ES	7822	2	LPG 2
Cinquecento	170	1.1	40	10.94 - 05.98	176B2000	4	0,8	BCPR6ES	2330	12	LPG 3
Cinquecento Sporting Fire	170	1.1	40	94 - 05.98	176A6000	4	0,8	BCPR6ES	2330	12	LPG 3
Cinquecento Sport	170	1.2	55	04.96 - 05.98	176B2000	4	0,8	BCPR6ES	2330	12	LPG 3

**COUPÉ FIAT**

Coupé 1.8L 16V	FA/175	1.8	96	02.96 - 02.01	183A1000	4		BKR6EKC	2848	26	LPG 1
Coupé 2.0L 16V	FA/175	2.0	103	02.94 - 09.96	836A3000	4	0,8	BPR7ES	2023	19	BPR8EIX
Coupé 2.0L 20 V	FA/175	2.0	108	10.96 - 02.01	182A1000	5		BKR6EKC	2848	26	LPG 1
Coupé 2.0L 16V Turbo	FA/175	2.0	140	02.94 - 09.96	175A1000	4		BUR6ET	3172	1	LPG 2
Coupé 2.0L 20V Turbo	FA/175	2.0	162	- 12.96	175A3000	5		BKR6EKC	2848	26	LPG 1
Coupé 2.0L 20V Turbo	FA/175	2.0	162	10.96 - 02.01	175A3000	5		BKUR6ET	6437	27	LPG 1

**CROMA 1**

Croma TD (TDId)		1.9	69	07.90 - 98	154 C6000; 154 D 1000	4		Y-739R	6639		
Croma 2.0L		2.0	66	86 - 91	154C2000	4	0,8	BPR7ES	2023	19	BPR8EIX
Croma CHT- 2.0L		2.0	72	91 - 02.97	154C5000	4	0,8	BPR7ES	2023	19	BPR8EIX
Croma 2.0L		2.0	84	86 - 02.97	834B146	4	0,8	BPR7ES	2023	19	BPR8EIX
Croma 2.0L		2.0	85	07.91 - 02.97	154C3046 Cat.	4	0,8	BPR7ES	2023	19	BPR8EIX
Croma 2.0L -.S		2.0	85	04.95 - 99		4	0,8	BPR7ES	2023	19	BPR8EIX
Croma I 2.0L		2.0	86	91 - 02.97	154C3000	4	0,8	BPR7ES	2023	19	BPR8EIX
Croma 2.0L		2.0	89	86 - 91	154C000	4	0,8	BPR7ES	2023	19	BPR8EIX
Croma 16V- 2.0L		2.0	101	91 - 02.97	154E1000	4	0,8	BPR7ES	2023	19	BPR8EIX
Croma 2.0L - 16V		2.0	101	04.95 - 06.00		4	0,8	BPR7ES	2023	19	BPR8EIX
Croma Ti Turbo		2.0	110	86 - 02.97	154C4000	4		BP6ET	1263		LPG 2
Croma Ti Turbo		2.0	110	86 - 02.97	834C146	4		BP6ET	1263		LPG 2
Croma Turbo		2.0	110	91 - 02.97	154C4.046 /Cat.	4		BP6ET	1263		LPG 2
Croma Turbo 2.0L		2.0	110	04.95 - 06.00		4		BUR6ET	3172	1	LPG 2
Croma Turbo		2.0	114	86 - 02.97	154A2000	4		BP6ET	1263		LPG 2
Croma Td		2.5	85	02.89 - 12.92	8144.97.200/.2200	4		Y-908R	4585	1	
Croma TD		2.5	85	01.94 - 99		4		Y-926U	7119		
Croma		2.5	90	01.93 - 12.93		4		Y-914U	2643	1	
Croma 2.5L		2.5	90	01.94 - 98		4		Y-914U	2643	1	
Croma V6- 2.5L		2.5	117	93 - 02.97	834G.000	6	0,8	BPR7ES	2023	19	BPR8EIX
Croma V6- 2.5L		2.5	117	04.95 - 99		6	0,8	BPR7ES	2023	19	BPR8EIX

**CROMA 2**

Croma 1.8 16V	194	1.8	103	06.05 -	939A4000	4	1,1	ZFR5F-11	2262		LPG 6
Croma 1.9 D Mjet	194	1.9	85	06.05 - 08.06	939A7000	4		Y-534J	3413	36	
Croma 1.9 D Mjet	194	1.9	85	09.06 -	939A7000	4		Y1030J	90828	70	
Croma 1.9 D Mjet	194	1.9	88	06.05 - 08.06	939A1000	4		Y-534J	3413	36	
Croma 1.9 D Mjet	194	1.9	88	09.06 -	939A1000	4		Y1030J	90828	70	
Croma 1.9 D Mjet	194	1.9	100	10.05 - 10.07	939A8000	4		YE07	6092		
Croma 1.9 D Mjet 16V	194	1.9	110	06.05 -	939A2000	4		YE07	6092		

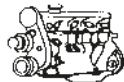
Code *l* kW

Cyl.



Stock-No.



LPG/CNG

**FIAT  
CROMA 2**

Croma 2.2 16V	194	2.2	108	06.05 -	194A1000	4		LTR6B-10T	5948		LTR6B-10T
Croma 2.4 D Mjet 20V	194	2.4	147	06.05 -	939A3000	5	☑	YE07	6092		

**DOBLÒ 1**

Doblò	119	1.2	48	11.00 - 12.04	223A5000	4	0,9	BKR5EZ	7642	36	LPG 1
Doblò	119	1.2	48	12.04 - 02.05	223A5000	4	1,0	DCPR7E-N-10	4983		LPG 8
Doblò MJ	119	1.3	51	11.03 - 12.05	188A9000	4	☑	Y8003J	97256	62	
Doblò 1.3 D Mjet	119	1.3	55	08.05 -	199A2000	4	☑	Y8003J	97256	62	
Doblò 1.3 D Mjet	119	1.3	62	11.05 -	223A9000	4	☑	Y8003J	97256	62	
Doblò	119	1.4	56	09.05 -	350A1000	4	1,0	ZKR7A-10	1691		LPG 8
Doblò 1.6	119	1.6	76	11.00 - 06.05	182B6000	4	0,9	BKR5EZ	7642	36	LPG 1
Doblò Natural Power	119	1.6	76	11.00 -	182B6000	4		BKR6EKC	2848	26	LPG 1
Doblò 1,9 D	119	1.9	46	11.00 - 04.04	223A6000	4	☑	Y-939J	5059	43	
Doblò 1.9 JTD	119	1.9	74	10.01 - 06.03	182B9000 / 223B2000	4	☑	Y-534J	3413	36	
Doblò 1.9 JTD	119	1.9	77	07.03 - 09.05	223A7000 / 223B1000	4	☑	Y-534J	3413	36	
Doblò 1.9 D Mjet	119	1.9	88	10.05 -	186A9000	4	☑	Y1030J	90828	70	

**DOBLÒ 2**

Doblò 1.3 D Mjet	152	1.3	66	02.10 -	199A3000 / 263A2000	4	☑	Y8003J	97256	62	
Doblò 1.4	152	1.4	70	02.10 -	843A1000	4	1,0	DCPR7E-N-10	4983		LPG 8
Doblò 1.4 T-Jet	152	1.4	88	10.11 -	198A4000	4	0,8	IKR9J8	93311		IKR9J8
Doblò 1,4 T-Jet Natural Power	152	1.4	88	02.10 -	198A4000	4	0,8	IKR9J8	93311		IKR9J8
Doblò 1.6 D Mjet	152	1.6	66	02.10 -	263A4000	4	☑	Y9003AS	94251	78	
Doblò 1.6 D Mjet	152	1.6	74	02.10 -	263A3000	4	☑	Y9003AS	94251	78	
Doblò 1.6 D Mjet	152	1.6	77	02.10 -	198A3000	4	☑	Y9003AS	94251	78	
Doblò 2.0 D Mjet	152	2.0	99	02.10 -	263A1000	4	☑	Y9003AS	94251	78	

**DUCATO**

Ducato 10D D		1.9	51	03.94 -		4	☑	Y-914U	2643	1	
Ducato 10TD		1.9	59	03.94 -	Kat.	4	☑	Y-922R	4356	1	
Ducato 10TD		1.9	60	03.94 -		4	☑	Y-914U	2643	1	
Ducato 14 TD		1.9	60	01.90 - 02.94	280A1000	4	☑	Y-914U	2643	1	
Ducato 10 D		2.0	52	02.87 -	149B1000	4	☑	Y-924J	7906	1	
Ducato 14		2.0	55	01.86 - 01.94	170BXN1T/ 170DXN 1TA	4	0,7	BP6ES	7811	4	LPG 2
Ducato 10 TD		2.0	60	01.90 - 02.94	280A1000	4	☑	Y-914U	2643	1	
Ducato 10		2.0	62	06.88 -	170D XN 1TA	4	0,7	BP6ES	7811	4	LPG 2
Ducato 10-14 Maxi		2.0	80	01.94 -	RFW	4	0,7	BP6ES	7811	4	LPG 2
Ducato 115 Mjet 2.0 D		2.0	85	06.11 -	250A1000	4	☑	Y9003AS	94251	78	
Ducato 100 Mjet 2.2 D		2.2	74	07.06 -	4HV	4	☑	Y-548J	94832	75	
Ducato 120 Mjet 2.3 D		2.3	88	04.02 -	F1AE0481C / F1AE0481D / F1AE0481N	4	☑	Y8005J	96853	64	
Ducato 14 TD		2.4	68	01.86 - 02.94	8144.21.220	4	☑	Y-908R	4585	1	
Ducato 14 D		2.4		01.86 - 02.94		4	☑	Y-908R	4585	1	
Ducato 10 D		2.5	53	01.86 - 02.94	8144.67	4	☑	Y-908R	4585	1	
Ducato 14 D		2.5	55	01.86 - 02.94	8144.67.220	4	☑	Y-908R	4585	1	
Ducato 14 D 4x4		2.5	55	01.89 - 02.94	8144.67.220	4	☑	Y-908R	4585	1	
Ducato TD		2.5	68	01.86 - 02.94		4	☑	Y-908R	4585	1	
Ducato 14 TD 4x4		2.5	68	01.89 - 02.94	8144.21.220	4	☑	Y-914U	2643	1	
Ducato 14 TDi		2.5	81	03.94 -	8140.47.2280 Kat.		☑	Y-910J	3617	3	



Code *l* kW

Cyl.

Stock-No.  
**VEFINE**  
BY-PROMOTER

LPG/CNG

**FIAT****DUCATO**

Ducato 18 Maxi D		2.5	55	01.86 - 02.94			4	Y-910J	3617	3	
Ducato 18 Maxi TD		2.5	68	01.86 - 02.94	8144.21.220		4	Y-908R	4585	1	
Ducato (230) 2,8D		2.8	64	02.98 -				Y-502R	3852		
Ducato 160 Mjet 3.0 D		3.0	115	06 -	F1CE0481D		4	Y8005J	96853	64	

**FIORINO**

Fiorino D		1.3	33	06.90 - 08.93	146B1000		4	Y-924J	7906	1	
Fiorino		1.4	51	01.93 -	160.A1.046		4	0,9 BPR5ES	7422	6	LPG 2
Fiorino		1.5	55	01.90 - 08.93	149C1000 Cat.		4	0,8 BPR6ES	7822	2	LPG 2
Fiorino D		1.7	42	01.88 -	149 B4.046		4	Y-924J	7906	1	
Fiorino D		1.7	43	12.87 -	149B3000		4	Y-924J	7906	1	
Fiorino 1.3 D Mjet EURO IV	225	1.3	55	02.08 -	199A2000		4	Y8003J	97256	62	
Fiorino 1.3 D Mjet EURO V	225	1.3	55	02.08 -	199A2000		4	Y9001AS	97719	72	
Fiorino 1.3 D Mjet	225	1.3	70	07.09 -	199B1000		4	Y9001AS	97719	72	
Fiorino 1.4	225	1.4	54	02.08 -	KFT / KFV		4	0,9 BKR6EZ	4619	38	LPG 1
Fiorino 1.4 Natural Power	225	1.4	57	10.09 -	350A1000		4	1,0 ZKR7A-10	1691		LPG 8

**FREEMONT**

Freemont 2.0 JTD	JC	2.0	100	08.11 -	940A5000		4	Y9003AS	94251	78	
Freemont 2.0 JTD	JC	2.0	103	08.11 -	940A5000		4	Y9003AS	94251	78	
Freemont 2.0 JTD	JC	2.0	120	08.11 -	940A4000		4	Y9003AS	94251	78	
Freemont 2.0 JTD	JC	2.0	125	08.11 -	940A4000 / 939B5000		4	Y9003AS	94251	78	

**GRANDE PUNTO**

Grande Punto 1.2	199	1.2	48	09.05 -	199A4000		4	1,0 ZKR7A-10	1691		LPG 8
Grande Punto 1.3 D Mjet	199	1.3	55	09.05 -	199A2000		4	Y8003J	97256	62	
Grande Punto 1.3 D Mjet	199	1.3	62	04.10 -	223A9000		4	Y8003J	97256	62	
Grande Punto 1.3 D Mjet	199	1.3	62	04.10 -	199B4000		4	Y9001AS	97719	72	
Grande Punto 1.3 D Mjet	199	1.3	66	12.05 -	199A3000		4	Y8003J	97256	62	
Grande Punto 1.4	199	1.4	55	06.06 -	199A7000		4	1,0 ZKR7A-10	1691		LPG 8
Grande Punto 1.4	199	1.4	57	09.05 -	350A1000		4	1,0 ZKR7A-10	1691		LPG 8
Grande Punto 1.4 NATURAL POWER	199	1.4	57	09.08 -	350A1000		4	1,0 ZKR7A-10	1691		LPG 8
Grande Punto 1.4 LPG	199	1.4	57	02.09 -			4	1,0 ZKR7A-10	1691		LPG 8
Grande Punto 1.4 16V	199	1.4	70	09.05 - 08	199A6000		4	1,0 ZKR7A-10	1691		LPG 8
Grande Punto 1.4 T-Jet	199	1.4	88	06.07 -	198A4000		4	0,8 IKR9J8	93311		IKR9J8
Grande Punto 1.4 Abarth	199	1.4	114	12.07 - 06.10	199A8000		4	0,8 IKR9J8	93311		IKR9J8
Grande Punto 1.4 Abarth	199	1.4	132	04.09 -	199A8000		4	0,8 IKR9J8	93311		IKR9J8
Grande Punto 1.9 D Mjet	199	1.9	85	06.06 -	939A7000		4	Y1030J	90828	70	
Grande Punto 1.9 D Mjet	199	1.9	88	10.05 -	939A1000		4	Y1030J	90828	70	
Grande Punto 1.9 D Mjet	199	1.9	96	10.05 -	199A5000		4	Y1030J	90828	70	

**IDEA**

Idea 1.2 16V	350	1.2	59	02.05 -	188A5000		4	1,0 DCPR7E-N-10	4983		LPG 8
Idea 1.3 D Mjet	350	1.3	51	06.03 -	188A9000		4	Y8003J	97256	62	
Idea 1.3 D Mjet	350	1.3	66	11.05 -	199A3000		4	Y8003J	97256	62	
Idea 1.3 D Mjet EURO V	350	1.3	68	04.09 -	199B1000		4	Y9001AS	97719	72	
Idea 1.4	350	1.4	57	09.05 -	350A1000		4	1,0 ZKR7A-10	1691		LPG 8
Idea 1.4 LPG	350	1.4	57	03.09 -	350A1000		4	1,0 ZKR7A-10	1691		LPG 8
Idea	350	1.4	70	10.03 - 02.05	843A1000		4	0,9 DCPR7E-N	4795		LPG 8
Idea 1.4 16V	350	1.4	70	02.05 -	843A1000		4	1,0 DCPR7E-N-10	4983		LPG 8
Idea 1.6 D Mjet	350	1.6	88	07.08 -	350A2000		4	Y9003AS	94251	78	

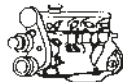
Code *l* kW

Cyl.



Stock-No.



LPG/CNG

**FIAT  
IDEA**

Idea 1.9 MJT	350	1.9	74	10.03 -	188B2000	4		Y-534J	3413	36	
<b>LINEA</b>											
Linea 1.3 D Mjet	323	1.3	66	06.07 -	199A3000	4		Y8003J	97256	62	
Linea 1.4	323	1.4	57	06.07 -	350A1000	4	1,0	ZKR7A-10	1691		LPG 8
Linea 1.4 T-Jet	323	1.4	88	09.07 -	198A4000	4	0,8	IKR9J8	93311		IKR9J8
Linea 1.6 D Mjet	323	1.6	77	06.09 -	198A3000	4		Y9003AS	94251	78	

**MAREA**

Marea i.;80 16V ,Weekend	185	1.2	59	03.98 - 05.99	182B2000	4		DCPR8EKC	7168		LPG 8
Marea 80 16V Sx,Hsx; Weekend	185	1.2	60	12.98 - 12.00	182B2000	4	0,9	DCPR8E-N	5692		LPG 8
Marea i. 12 V; Weekend	185	1.4	55	10.96 - 02.98	182A3000	4		BKR6EKC	2848	26	LPG 1
Marea i. 16V; Weekend	185	1.6	76	09.96 - 04.98	182A4000	4		BKR6EKC	2848	26	LPG 1
Marea i. 16V Sx Bipower	185	1.6	76	11.97 - 12.03	182A4000	4		BKR6EKC	2848	26	LPG 1
Marea 100 16V,Sx,Elx,Aut., Weekend	185	1.6	76	12.98 - 12.03	182A4000	4	0,9	BKR5EZ	7642	36	LPG 1
Marea 16V Sx,Elx,Aut., Weekend	185	1.6	76	05.98 - 11.98	182A4000	4	0,9	BKR5EZ	7642	36	LPG 1
Marea i. 16 V, Weekend	185	1.8	83	09.96 - 11.98	182A2000	4		BKR6EKC	2848	26	LPG 1
Marea 115 16V; Weekend	185	1.8	83	12.99 - 01.01	182A2000	4		BKR6EKC	2848	26	LPG 1
Marea	185	1.9	55	09.96 - 12.00	182A8000	4		Y-928U	4389	29	
Marea	185	1.9	74	09.96 - 12.00	182A7000	4		Y-928U	4389	29	
Marea JTD	185	1.9	74	01.01 - 12.01	182B9000	4		Y-534J	3413	36	
Marea / Marengo JTD	185	1.9	77	04.99 - 11.99	182B4000 fino a n. motore —>1713819	4		Y-747U	4694	26	
Marea JTD	185	1.9	77	12.99 - 01.01	182B4000 dal n. motore 1713820 —>	4		Y-534J	3413	36	
Marea / Marengo JTD	185	1.9	81	01.02 -	186A6000	4		Y-534J	3413	36	
Marea 20V	185	2.0	108	09.96 - 11.98	182A1000	5		BKR6EKC	2848	26	LPG 1
Marea i. 155 20 V Weekend	185	2.0	108	10.96 - 12.03	182A1000	5		BKR6EKC	2848	26	LPG 1
Marea	185	2.4	91	09.96 - 12.00	185A2000	5		Y-928U	4389	29	
Marea JTD	185	2.4	100	12.99 - 09.02	185A6000 dal n. motore 1713820 —>	5		Y-534J	3413	36	
Marea JTD	185	2.4	100	03.99 - 11.99	185A6000 fino a n. motore —>1713819	5		Y-747U	4694	26	

**MULTIPLA**

Multipla 100 16V Bluepower	186	1.6	70	01.99 - 12.04	186A3000	4		BKR6EKC	2848	26	LPG 1
Multipla 100 16V Bipower	186	1.6	76	01.99 - 12.04	186A4000	4		BKR6EKC	2848	26	LPG 1
Multipla 100 16V Sx	186	1.6	76	01.99 - 06.99	186A4000	4		BKR6EKC	2848	26	LPG 1
Multipla 100 16V Sx	186	1.6	76	07.99 - 12.04	186A4000	4	0,9	BKR5EZ	7642	36	LPG 1
Multipla 1.6 16V	186	1.6	76	09.04 -	182B6000	4	0,9	BKR5EZ	7642	36	LPG 1
Multipla 1.6 16V NATURAL POWER	186	1.6	76	09.04 -	182B4000	4		BKR6EKC	2848	26	LPG 1
Multipla JTD	186	1.9	77	11.98 - 11.99	182B4000 fino a n. motore —>1692991	4		Y-747U	4694	26	
Multipla JTD	186	1.9	77	12.99 - 02.01	82B4000 dal n. motore —>1692992	4		Y-534J	3413	36	
Multipla JTD	186	1.9	81	02.01 - 07.02	186A6000	4		Y-534J	3413	36	
Multipla 1.9 MJT EURO III	186	1.9	85	07.02 - 09.05	186A8000	4		Y-534J	3413	36	
Multipla 1.9 D Mjet EURO IV	186	1.9	85	10.03 - 12.10	186A8000	4		Y1030J	90828	70	
Multipla 1.9 D Mjet	186	1.9	88	04.02 -	186A9000	4		Y1030J	90828	70	

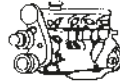
Code *l* kW

Cyl.

Stock-No.  
**VEFINE**  
BY-PROMOTER

LPG/CNG

**FIAT****PALIO**

Palio 1,9 D	178	1,9	46	01 -	223A6000	4		Y-939J	5059	43	
Palio 8V	178	1.2	44	01.01 -	188A4000	4	0,9	BKR5EZ	7642	36	LPG 1
Palio 65 1.2L	178	1.2	50	01.00 - 12.00	178E2000	4		BKR6EKC	2848	26	LPG 1
Palio 75 Weekend	178	1.2	54	11.97 - 12.00	178B5000	4		BKR6EKC	2848	26	LPG 1
Palio 16V	178	1.2	59	09.01 - 11.02	188A5000	4	0,9	DCPR8E-N	5692		LPG 8
Palio 16V	178	1.2	59	12.02 -	188A5000	4	0,9	DCPR7E-N	4795		LPG 8
Palio 1.4L	178	1.4	51	09.97 -	178B2000	4	0,9	BKR5EZ	7642	36	LPG 1
Palio 1.6L 16V	178	1.6	74	96 - 06.99	182B6000	4		BKR6EKC	2848	26	LPG 1
Palio 100 16V Weekend	178	1.6	76	11.97 - 06.99	178B3000	4		BKR6EKC	2848	26	LPG 1
Palio 100 16V Weekend	178	1.6	76	07.99 -	178B3000	4	0,9	BKR5EZ	7642	36	LPG 1
Palio TD	178	1.7	51	97 -		4		Y-922R	4356	1	

**PANDA 1**

Panda 1 750 CLX -CL-L- Fire	141	0.75	24	01.86 - 12.96	156A...	4	0,8	BCPR6ES	2330	12	LPG 3
Panda 1 750 Young	141	0.75	25	01.86 - 12.96	141B000	4	0,8	BPR6ES	7822	2	LPG 2
Panda 1 900	141	0.9	29	- 12.96	1170A1046	4	0,8	BPR6ES	7822	2	LPG 2
Panda 1 i.	141	0.9	29	01.96 - 01.01		4	0,8	BPR6ES	7822	2	LPG 2
Panda 1 900- Jolly-Van	141	0.9	29	01.97 - 01.01	1170 A1046	4	0,9	BKR5EZ	7642	36	LPG 1
Panda 1 45 / 45 S / 4x4	141	0.9	33	- 12.96	146A..	4	0,8	BPR6ES	7822	2	LPG 2
Panda 1	141	1.1	40	09.00 -	187A1000	4	0,9	BKR5EZ	7642	36	LPG 1
Panda 1 1000	141	1.0	32	01.86 - 04.96	156A2048-	4	0,8	BCPR6ES	2330	12	LPG 3
					156A2146/246						
Panda 1 1.0 L- young-L- CLX	141	1.0	33	06.94 - 12.97	141C2000	4	0,8	BPR6ES	7822	2	LPG 2
Panda 1 Van	141	1.0	33	01.97 -	141C2000	4		BKR6EKC	2848	26	LPG 1
Panda 1 1100 Selecta	141	1.1	37	07.90 - 12.96	156C046 Cat.	4	0,8	BCPR6ES	2330	12	LPG 3
Panda 1 1100	141	1.1	40	02.95 - 12.96	176B2000	4	0,8	BCPR6ES	2330	12	LPG 3
Panda 1 4x4	141	1.1	40	02.95 - 12.96	176B2000	4	0,8	BCPR6ES	2330	12	LPG 3
Panda 1 4X4	141	1.1	40	01.96 - 08.00	156C046	4	0,8	BCPR6ES	2330	12	LPG 3
Panda 1 1100 Selecta Van	141	1.1	40	01.97 - 08.00	176B2000	4		BKR6EKC	2848	26	LPG 1

**PANDA 2**

Panda 2 1.1	169	1.1	40	09.03 - 12.04	187A1000	4	0,9	BKR5EZ	7642	36	LPG 1
Panda 2 1.1 Eco	169	1.1	40	12.04 -	187A1000	4	1,0	DCPR7E-N-10	4983		LPG 8
Panda 2 1.2 / 4x4	169	1.2	44	10.04 -	188A4000	4	1,0	DCPR7E-N-10	4983		LPG 8
Panda 2 1.2 Natural Power	169	1.2	44	06.06 -	188A4000	4	1,0	DCPR7E-N-10	4983		LPG 8
Panda 2 1.2 LPG	169	1.2	44	02.09 -		4	1,0	DCPR7E-N-10	4983		LPG 8
Panda 2 1.2	169	1.2	51	03.10 -	169A4000	4	1,0	ZKR7A-10	1691		LPG 8
Panda 2 1.2 Easypower LPG Euro V	169	1.2	51	11.10 -	169A4000	4	0,8	ZKR7AI-8	92402		ZKR7AI-8
Panda 2 1.3 D Mjet	169	1.3	51	09.03 -	188A8000	4		Y8003J	97256	62	
Panda 2 1.3 D Mjet	169	1.3	55	07.06 -	169A1000	4		Y8003J	97256	62	
Panda 2 1.3 D Mjet 4x4	169	1.3	55	03.10 -	169A1000	4		Y9001AS	97719	72	
Panda 2 1.4 16V 100 HP	169	1.4	74	06.07 -	169A3000	4	1,0	DCPR7E-N-10	4983		LPG 8

**PANDA 3**

Panda 3 0.9	312	0.9	63	01.12 -	312A4000	2	0,8	ILKR9G8	97168		ILKR9G8
Panda 3 1.0	312	1.0	48	01.12 -	169A4000	4	1,2	LKR7DI-12	90779		
Panda 3 1.2	312	1.2	51	01.12 -	169A1000 / 169A9000	4	1,0	ZKR7A-10	97719		LPG 8
Panda 3 1.3 D Mjet	312	1.3	55	01.12 -	312A2000	4		Y9001AS	97719	72	

**PUNTO 1 (176)**

Punto 1 55	176	1.1	40	11.93 - 05.97	176A6000	4	0,8	BCPR6ES	2330	12	LPG 3
Punto 1 55 S; Sx; 6 Speed	176	1.1	40	06.97 - 09.99	176B2000	4	0,8	BCPR6ES	2330	12	LPG 3
Punto 1 60	176	1.2	43	06.94 - 05.98	176A7000	4	0,8	BCPR6ES	2330	12	LPG 3

Code *l* kW

Cyl.



Stock-No.



LPG/CNG

**FIAT**  
**PUNTO 1 (176)**

Punto 1 60	176	1.2	44	11.93 - 05.97	176B1000	4	0,8	BCPR6ES	2330	12	LPG 3
Punto 1 60	176	1.2	44	06.97 - 09.99	176B4000	4	0,8	BCPR6ES	2330	12	LPG 3
Punto 1 75	176	1.2	54	11.93 - 05.98	176A8000	4	0,8	BCPR6ES	2330	12	LPG 3
Punto 1 85 16V	176	1.2	63	05.97 - 09.01	176B9000	4	0,9	DCPR8E	4339		LPG 8
Punto 1 GT Turbo	176	1.4	96	06.93 - 09.99	176 B6000/ 176A4000	4		BCPR6ET	2197		LPG 3
Punto 1 90	176	1.6	65	01.94 - 05.97	176A9000	4	0,9	BCPR7ES	3330		BCPR7EIX
Punto 1 90 Cabrio ELX	176	1.6	65	06.94 - 05.98	176A9000	4	0,9	BCPR7ES	3330		BCPR7EIX
Punto 1 Sporting	176	1.6	65	07.95 - 05.97	176A9000	4	0,9	BCPR7ES	3330		BCPR7EIX
Punto 1 1.7 D	176	1.7	42	11.94 - 09.97	176B3000	4	☑	Y-924J	7906	1	
Punto 1 S, SX, ELX TD	176	1.7	53	06.93 - 09.96	176A3000	4	☑	Y-924J	7906	1	
Punto 1 70 TD	176	1.7	53	10.96 - 12.99	176A5000	4	☑	Y-924J	7906	1	

**PUNTO 2 (188)**

Punto 2 1.2L 8V	188	1.2	44	09.00 - 10.04	188A4000	4	0,9	BKR5EZ	7642	36	LPG 1
Punto 2 1.2 Classic	188	1.2	44	10.04 -	188A4000	4	1,0	DCPR7E-N-10	4983		LPG 8
Punto 2 1.2 Natural Power	188	1.2	44	01.04 - 10.04	188A4000	4	0,9	BKR5EZ	7642	36	LPG 1
Punto 2 1.2 Natural Power Classic	188	1.2	44	02.05 -	188A4000	4	1,0	DCPR7E-N-10	4983		LPG 8
Punto 2 1.2 16V	188	1.2	59	09.00 - 11.02	188A5000	4	0,9	DCPR8E-N	5692		LPG 8
Punto 2 1.2 16V	188	1.2	59	12.02 - 02.05	188A5000	4	0,9	DCPR7E-N	4795		LPG 8
Punto 2 1.2 16V	188	1.2	59	02.05 -	188A5000	4	1,0	DCPR7E-N-10	4983		LPG 8
Punto 2 1.3 D Mjet	188	1.3	51	12.03 -	188A9000	4	☑	Y8003J	97256	62	
Punto 2 1.4L 16V	188	1.4	70	06.03 -	843A1000	4	0,9	DCPR7E-N	4795		LPG 8
Punto 2 1,8 HGT	188	1.8	96	09.00 - 08.02	188 A000	4		BKR6EKC	2848	26	LPG 1
Punto 2 1,8 HGT	188	1.8	96	09.02 -	188 A000	4	0,9	BKR6EZ	4619	38	LPG 1
Punto 2 1.9 DS	188	1.9	44	09.99 - 03	188A3000	4	☑	Y-939J	5059	43	
Punto 2 1.9 JTD	188	1.9	59	10.99 - 12.00	188A2000	4	☑	Y-534J	3413	36	
Punto 2 1.9 JTD	188	1.9	63	01.01 - 06.03	188A7000	4	☑	Y-534J	3413	36	
Punto 2 1.9 JTD	188	1.9	63	07.03 -	188A7000	4	☑	Y1030J	90828	70	
Punto 2 1.9 D Mjet	188	1.9	74	07.03 - 06.05	188B2000	4	☑	Y1030J	90828	70	

**PUNTO 3 (199)**

Punto 3 0.9	199	0.9	63	03.12 -	312A2000	2	0,8	ILKR9G8	97168		ILKR9G8
Punto 3 1.2	199	1.2	51	03.12 -	169A4000	4	1,0	ZKR7A-10	1691		LPG 8
Punto 3 1.3 D Mjet EURO IV	199	1.3	55	03.12 -	199A2000 / 199A9000	4	☑	Y8003J	97256	62	
Punto 3 1.3 D Mjet EURO V	199	1.3	55	03.12 -	199A2000 / 199A9000	4	☑	Y9001AS	97719	72	
Punto 3 1.3 D Mjet EURO IV	199	1.3	62	03.12 -	199B4000	4	☑	Y8003J	97256	62	
Punto 3 1.3 D Mjet EURO V	199	1.3	62	03.12 -	199B4000	4	☑	Y9001AS	97719	72	
Punto 3 1.3 D Mjet EURO IV	199	1.3	70	03.12 -	199B1000	4	☑	Y8003J	97256	62	
Punto 3 1.3 D Mjet EURO V	199	1.3	70	03.12 -	199B1000	4	☑	Y9001AS	97719	72	
Punto 3 1.4 Euro IV	199	1.4	55	03.12 -	199A7000	4	1,0	ZKR7A-10	1691		LPG 8
Punto 3 1.4 Euro V	199	1.4	55	03.12 -	199A7000	4	0,8	ZKR7AI-8	92402		ZKR7AI-8
Punto 3 1.4 Euro IV	199	1.4	57	03.12 -	350A1000	4	1,0	ZKR7A-10	1691		LPG 8
Punto 3 1.4 Euro V	199	1.4	57	03.12 -	350A1000	4	0,8	ZKR7AI-8	92402		ZKR7AI-8
Punto 3 1.4 Natural Power CNG	199	1.4	57	03.12 -	350A1000	4	1,0	ZKR7A-10	1691		LPG 8
Punto 3 1.4 MultiAir	199	1.4	77	03.12 -	955A6000	4	1,0	DCPR7E-N-10	4983		LPG 8
Punto 3 1.4 Turbo MultiAir	199	1.4	99	03.12 -	955A2000	4	0,8	IKR9J8	93311		IKR9J8
Punto 3 1.6 D Mjet	199	1.6	88	01.08 - 12.09	955A3000	4	☑	Y9003AS	94251	78	

**PUNTO EVO**

Punto EVO 1.2	199	1.2	48	09.09 -	199A4000	4	1,0	ZKR7A-10	1691		LPG 8
Punto EVO 1.2	199	1.2	51	10.09 -	169A4000	4	1,0	ZKR7A-10	1691		LPG 8
Punto EVO 1.3 D Mjet	199	1.3	51	10.09 -	199B2000	4	☑	Y9001AS	97719	72	



Code *l* kW

Cyl.

Stock-No.  
**VEFINE**  
BY-PROMOTER

LPG/CNG

**FIAT****PUNTO EVO**

Punto EVO 1.3 D Mjet EURO IV	199	1.3	55	06.09 -	199A2000	4	☑	Y8003J	97256	62	
Punto EVO 1.3 D Mjet EURO V	199	1.3	55	06.09 -	199A2000 / 199A9000	4	☑	Y9001AS	97719	72	
Punto EVO 1.3 D Mjet	199	1.3	62	10.09 -	199B4000 / 223A9000	4	☑	Y9001AS	97719	72	
Punto EVO 1.3 D Mjet	199	1.3	66	06.09 -	199A3000	4	☑	Y8003J	97256	62	
Punto EVO 1,3 Mjet Stop&Start	199	1.3	70	06.09 -	199B1000	4	☑	Y9001AS	97719	72	
Punto EVO 1.4	199	1.4	55	07.09 -	199A7000	4	1,0	ZKR7A-10	1691		LPG 8
Punto EVO 1.4	199	1.4	57	09.09 -	350A1000	4	1,0	ZKR7A-10	1691		LPG 8
Punto EVO 1.4 Natural Power CNG	199	1.4	57	09.09 -	350A1000	4	1,0	ZKR7A-10	1691		LPG 8
Punto EVO 1,4 Multiair	199	1.4	77	09.09 -	955A6000	4	1,0	DCPR7E-N-10	4983		LPG 8
Punto EVO 1.4 Turbo Multiair	199	1.4	99	09.09 -	955A2000	4	0,8	IKR9J8	93311		IKR9J8
Punto EVO 1.4 Abarth	199	1.4	120	10.09 -	955A8000	4	0,8	IKR9J8	93311		IKR9J8
Punto EVO 1,6 D Mjet	199	1.6	88	09.09 -	955A3000	4	☑	Y9003AS	94251	78	

**QUBO**

Qubo 1.3 D Mjet EURO IV	225	1.3	55	10.07 -	199A2000	4	☑	Y8003J	97256	62	
Qubo 1.3 D Mjet EURO V	225	1.3	55	09.08 -	199A2000	4	☑	Y9001AS	97719	72	
Qubo 1.3 D Mjet	225	1.3	70	11.09 -	199B1000	4	☑	Y9001AS	97719	72	
Qubo 1.4	225	1.4	54	09.08 -	KFT / KFV	4	0,9	BKR6EZ	4619	38	LPG 1
Qubo 1,4 Natural Power	225	1.4	57	10.09 -	350A1000	4	1,0	ZKR7A-10	1691		LPG 8

**SCUDO**

Scudo		1.6	58	02.96 -	220A2000	4	0,8	BCPR7ES	3330		BCPR7EIX
Scudo D		1.9	51	03.96 -		4	☑	Y-923U	3380	1	
Scudo TD		1.9	68	03.96 -		4	☑	Y-923U	3380	1	
Scudo		1.9		09.98 -	DW8, DW8TD, WJZ	4	☑	Y-503R	4279	10	
Scudo		1.9		09.98 -	XUD9TF	4	☑	Y-938R	5267	1	
Scudo		2.0	100	11.06 -	RHR	4	☑	Y1005J	7957	56	
Scudo		2.0	88	11.06 -	RHG	4	☑	Y1005J	7957	56	
Scudo		2.0	88	11.06 -	RHK	4	☑	Y1005J	7957	56	

**SEDICI**

Sedici 1.6 16V	189	1.6	79	09.05 -	M16A	4	1,1	IFR6J11	7658		IFR6J11
Sedici 1.6 16V	189	1.6	88	09.09 -	M16A	4	1,1	IFR6J11	7658		IFR6J11
Sedici 1.9D Mjet	189	1.9	88	01.06 -	D19AA	4	☑	Y-534J	3413	36	
Sedici 2.0D Mjet	189	2.0	99	09.09 -	D20AA	4	☑	Y9003AS	94251	78	

**SEICENTO**

Seicento 900 i.e. S; SX; Citymatic	187	0.9	29	05.98 - 12.00	1170A1046	4	0,8	BPR6ES	7822	2	LPG 2
Seicento Sporting	187	1.1	40	03.98 - 09.00	176B2000	4	0,8	BCPR6ES	2330	12	LPG 3
Seicento 1100	187	1.1	40	05.98 - 09.00	176B2000	4	0,8	BCPR6ES	2330	12	LPG 3
Seicento 1100	187	1.1	40	10.00 - 10.04	187A1000	4	0,9	BKR5EZ	7642	36	LPG 1
Seicento 1.1	187	1.1	40	10.04 -	187A1000	4	1,0	DCPR7E-N-10	4983		LPG 8

**SIENA**

Siena 1.4	178	1.4	51	11.97 -	178 B2000	4	0,9	BKR5EZ	7642	36	LPG 1
-----------	-----	-----	----	---------	-----------	---	-----	--------	------	----	-------

**STILO**

Stilo 1.2 16V	192	1.2	59	09.01 - 11.02	188A5000	4	0,9	DCPR8E-N	5692		LPG 8
Stilo 1.2 16V	192	1.2	59	12.02 - 06.04	188A5000	4	0,9	DCPR7E-N	4795		LPG 8
Stilo 1.4 16V / SW	192	1.4	70	01.04 - 02.05	843A1000	4	0,9	DCPR7E-N	4795		LPG 8
Stilo 1.4 16 V /SW	192	1.4	70	02.05 -	843A1000	4	1,0	DCPR7E-N-10	4983		LPG 8
Stilo 1.6	192	1.6	76	09.01 - 05.06	182B6000	4	0,9	BKR5EZ	7642	36	LPG 1
Stilo 1.6 SW	192	1.6	76	09.02 -	182B6000	4	0,9	BKR5EZ	7642	36	LPG 1
Stilo 1.8 16V	192	1.8	96	09.01 -	192A4000	4	0,9	BKR6EZ	4619	38	LPG 1

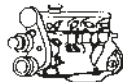
Code *l* kW

Cyl.



Stock-No.



LPG/CNG

**FIAT  
STILO**

Stilo 1.8 SW	192	1.8	98	09.02 -	192A4000	4	0,9	BKR6EZ	4619	38	LPG 1
Stilo 1.9 JTD	192	1.9	59	09.01 - 08.04	192A3000	4	█	Y-534J	3413	36	
Stilo 1.9 JTD	192	1.9	66	09.04 - 12.10	192B5000	4	█	Y1030J	90828	70	
Stilo 1.9 JTD	192	1.9	74	09.04 - 07.05	192A9000	4	█	Y-534J	3413	36	
Stilo 1.9 JTD	192	1.9	85	10.01 - 12.07	192A1000	4	█	Y-534J	3413	36	
Stilo 1.9 JTD	192	1.9	85	07.05 - 12.07	937A7000	4	█	Y1030J	90828	70	
Stilo 1.9 D Mjet	192	1.9	88	09.05 -	192A8000	4	█	Y1030J	90828	70	
Stilo 1.9 D Mjet 16V	192	1.9	103	01.04 - 09.05	192A5000	4	█	YE07	6092		
Stilo 1.9 D Mjet 16V	192	1.9	110	09.05 - 10.07	937A5000	4	█	YE07	6092		
Stilo 2.4 20V	192	2.4	125	09.01 -	192A2000	5	0,9	BKR6EZ	4619	38	LPG 1

**STRADA**

Strada	178E	1.2	48	10.04 -	178B7.045	4	1,0	DCPR7E-N-10	4983		LPG 8
Strada 75	178E	1.2	54	05.99 - 05	178B5000	4	0,9	BKR5EZ	7642	36	LPG 1
Strada	178E	1.2		01.99 - 10.05	188A4000	4	0,9	BKR5EZ	7642	36	LPG 1
Strada 1.3 D Mjet	178E	1.3	63	05.06 -	223A9000	4	█	Y8003J	97256	62	
Strada	178E	1.6		10.99 - 10.04	178D2011	4	0,9	BKR5EZ	7642	36	LPG 1
Strada 1.7 D	178E	1.7	51	06.99 -	176A3000	4	█	Y-924J	7906	1	
Strada 1.9 D	178E	1.9	46	12.00 - 03.03	223A6000	4	█	Y-939J	5059	43	
Strada 1.9 JTD	178E	1.9	59	04.03 - 06.05	188A2000	4	█	Y-534J	3413	36	

**TEMPRA**

Tempra 1.4- S.W- .S	159	1.4	51	10.94 - 10.96	836A4000	4	0,8	BPR6ES	7822	2	LPG 2
Tempra / SX / Sta. Wagon	159	1.4	56	03.90 - 10.96	159A2000	4	0,8	BPR6ES	7822	2	LPG 2
Tempra 1.6	159	1.6	55	02.90 - 12.94	159 A3048	4	0,8	BPR7ES	2023	19	BPR8EIX
Tempra 1.6	159	1.6	55	09.94 - 10.96	835C1000	4	0,9	BCPR7ES	3330		BCPR7EIX
Tempra 1.6 90CV-Liberty S.W.	159	1.6	66	03.95 -		4	0,9	BCPR7ES	3330		BCPR7EIX
Tempra ie SX, S.W.	159	1.8	74	05.95 -		4	0,8	BPR7ES	2023	19	BPR8EIX
Tempra 1800 i.e/a.Modelle	159	1.8	77	02.90 - 10.96	159A4046	4	0,8	BPR7ES	2023	19	BPR8EIX
Tempra D - SW	159	1.9	48	02.90 - 06.96	160 A7000	4	█	Y-924J	7906	1	
Tempra TD	159	1.9	59	07.90 -	160 B6046	4	█	Y-924J	7906	1	
Tempra TD /SW	159	1.9	66	02.90 -	160 A6000	4	█	Y-924J	7906	1	
Tempra TD	159	1.9	68	06.93 - 09.96	160 D1000	4	█	Y-922R	4356	1	
Tempra 2.0L	159	2.0	83	02.90 - 10.96	159A6046	4	0,8	BPR7ES	2023	19	BPR8EIX

**TIPO**

Tipo 1.1L	160	1.1	41	07.87 - 03.93	160A3000	4	0,8	BCPR6ES	2330	12	LPG 3
Tipo Selecta	160	1.4	53	02.88 -	160A1000	4	0,8	BPR6ES	7822	2	LPG 2
Tipo	160	1.4	57	01.90 - 05.95	159A2000	4	0,8	BPR6ES	7822	2	LPG 2
Tipo 1.6L	160	1.6	55	03.93 - 10.94	835C1000	4	0,9	BCPR7ES	3330		BCPR7EIX
Tipo i.e.	160	1.6	55	03.93 - 10.95	835C1000	4	0,8	BPR7ES	2023	19	BPR8EIX
Tipo i.e.	160	1.6	55	03.94 -		4	0,9	BCPR7ES	3330		BCPR7EIX
Tipo Selecta	160	1.6	57	01.92 - 03.93	159A3046	4	0,8	BPR7ES	2023	19	BPR8EIX
Tipo	160	1.6	63	04.90 - 12.92	159A3000 DOHC	4	0,8	BPR7ES	2023	19	BPR8EIX
Tipo i.e.	160	1.6	66	03.93 - 10.95	159 A3048	4	0,8	BPR7ES	2023	19	BPR8EIX
Tipo D	160	1.7	42	07.87 - 03.93	149B4000	4	█	Y-924J	7906	1	
Tipo IE SX / GT / SLX	160	1.8	76	11.91 - 10.95	835C2000	4	0,8	BPR7ES	2023	19	BPR8EIX
Tipo i.e. GT	160	1.8	80	03.92 - 03.93	139A4000	4	0,8	BPR7ES	2023	19	BPR8EIX
Tipo IE 16V	160	1.8	102	06.89 - 09.91	160A5000	4	█	BP6ET	1263		LPG 2
Tipo D	160	1.9	48	07.89 - 03.93	149A1000	4	█	Y-924J	7906	1	
Tipo TD	160	1.9	66	07.87 -	160D1000	4	█	Y-924J	7906	1	

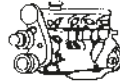
Code *l* kW

Cyl.

Stock-No.  
**VEFINE**  
BY-PROMOTER

LPG/CNG

**FIAT****TIPO**

Tipo TD	160	1.9	68	07.87 - 03.93	149A1000	4	☑	Y-924J	7906	1	
Tipo TD	160	1.9	68	06.93 - 12.94		4	☑	Y-922R	4356	1	
Tipo 2.0 L	160	2.0	83	03.90 - 03.92	159A6046	4	0,8	BPR7ES	2023	19	BPR8EIX
Tipo 2.0 L- GT / SLX	160	2.0	83	11.91 - 10.95	159A6046 Cat.	4	0,8	BPR7ES	2023	19	BPR8EIX
Tipo IE 16V	160	2.0	102	05.91 - 10.95	836A3000 Cat.	4	0,8	BPR7ES	2023	19	BPR8EIX
Tipo i.e. 16V	160	2.0	109	05.91 - 10.95	160A8046	4	0,8	BPR7ES	2023	19	BPR8EIX

**ULYSSE**

Ulysse TD		1.9	68	09.94 -	XUD 9 TU	4	☑	Y-923U	3380	1	
Ulysse 2.0 JTD		2.0	80	09.02 - 05.03	RHW (DW10ATED4)	4	☑	Y-504J	1441	24	
					fino a ric. n. → 9666						
Ulysse JTD		2.0	80	09.02 -	DW10ATED4/RHT	4	☑	Y-504J	1441	24	
Ulysse i.S		2.0	89	07.94 -	RFU	4		BKR5EK	7956	23	LPG 1
Ulysse		2.0	100	09.00 - 08.02	RFN	4	0,9	LFR5B	7113		LPG 7
Ulysse i.turbo		2.0	108	07.94 - 12.98	RGX	4		BKR6EK****	2288	20	BKR6EQUIP
Ulysse		2.0	100	05.06 -	RHR	4	☑	Y1005J	7957	56	
Ulysse		2.0	80	06.03 -	RHM	4	☑	Y1005J	7957	56	
Ulysse		2.0	81	06.02 - 07.06	RHW	4	☑	Y1005J	7957	56	
Ulysse		2.0	88	05.06 -	RHK	4	☑	Y1005J	7957	56	
Ulysse TD		2.1	80	07.96 -	XUD11ATE	4	☑	Y-923U	3380	1	
Ulysse JTD		2.2	94	09.02 -	DW12ATED4/4HW	4	☑	Y-504J	1441	24	
Ulysse 2.2 JTD		2.2	120	03.08 - 03.10	4HP / 4HR	4	☑	YE08	4966		
Ulysse 2.2 D Mjet		2.2	125	02.08 - 03.10	4HT / DW12BTED4	4	☑	YE08	4966		
Ulysse		2.2	96	06.02 - 07.07	4H01	4	☑	Y1005J	7957	56	
Ulysse		2.2	96	06.02 - 07.07	4HW	4	☑	Y1005J	7957	56	

**UNO**

Uno 45 ES/S/Sting/Trend	146	0.9	33	01.83 - 10.95	146A...	4	0,8	BPR6ES	7822	2	LPG 2
Uno 45	146	1.0	32	06.85 - 10.95	156A2...	4	0,8	BCPR6ES	2330	12	LPG 3
Uno 1.0L- Start	146	1.0	33	08.94 - 10.95	156A2000-2048	4	0,9	BPR5ES	7422	6	LPG 2
Uno 1.0 L	146	1.0	35	08.94 -		4	0,8	BPR6ES	7822	2	LPG 2
Uno 60 IE / S	146	1.1	37	07.91 - 10.95	156C046 Cat.	4	0,8	BCPR6ES	2330	12	LPG 3
Uno 60 S / SX / Fire	146	1.1	41	05.85 - 10.95	146A6000	4	0,8	BCPR6ES	2330	12	LPG 3
Uno 60 SL / Trend	146	1.1	41	09.89 - 09.92	146A6000	4	0,8	BPR6ES	7822	2	LPG 2
Uno 70 all models	146	1.4	51	83 - 10.95	160A1046	4	0,8	BPR6ES	7822	2	LPG 2
Uno 60 TD	146	1.4	51	03.86 - 09.92	146 B	4	☑	Y-924J	7906	1	
Uno i.e.	146	1.4	51	08.94 -		4	0,8	BPR6ES	7822	2	LPG 2
Uno TD	146	1.4	52	09.89 - 12.95	146B3000	4	☑	Y-924J	7906	1	
Uno Turbo IE/ Racing	146	1.4	82	09.89 - 12.93	146A8046 Cat.	4		BCPR7ET	2164		BCPR7EIX
Uno 75 I.E. SPi	146	1.5	55	12.87 - 10.95	149C1000	4	0,8	BPR6ES	7822	2	LPG 2
Uno 60 D	146	1.7	40	09.89 - 09.92	146B2000	4	☑	Y-924J	7906	1	
Uno D Van	146	1.7	42	09.89 - 03.96	146B2000	4	☑	Y-924J	7906	1	
Uno D	146	1.7		10.89 -		4	☑	Y-924J	7906	1	
Uno D	146	1.7		01.91 -		4	☑	Y-924J	7906	1	

**FORD****B-MAX**

B-Max 1.4	JK	1.4	66	10.12 -		4	1,3	TR5B-13	4559		LPG 4
B-Max 1.5 TDCi	JK	1.5	55	10.12 -		4	☑	Y8001AS	8904	58	
B-Max 1.6 TDCi	JK	1.6	70	10.12 -		4	☑	Y8001AS	8904	58	
B-Max 1.6 Ti	JK	1.6	77	10.12 -		4	1,3	TR5B-13	4559		LPG 4

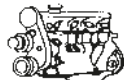
Code *l* kW

Cyl.



Stock-No.



LPG/CNG

**FORD  
COUGAR**

Cougar 2.0		2.0	96	08.98 - 01.01	EDBA ZETEC-E SEFI	4	1,3	PTR5A-13	2467	25	LPG 4
Cougar 2.0		2.0	96	08.98 - 01.01	EDBB ZETEC-E SEFI	4	1,3	PTR5A-13	2467	25	LPG 4
Cougar 2.0		2.0	96	08.98 - 01.01	EDBC ZETEC-E SEFI	4	1,3	PTR5A-13	2467	25	LPG 4
Cougar 2.0		2.0	96	08.98 - 01.01	EDBD ZETEC-E SEFI	4	1,3	PTR5A-13	2467	25	LPG 4
Cougar 2.5 V6		2.5	125	08.98 - 01.01	LCBA Duratec VE SEFI	6	1,0	PTR5D-10	3784	31	LPG 5
Cougar 2.5 V6		2.5	125	08.98 - 01.01	LCBB Duratec-VE SEFI	6	1,0	PTR5D-10	3784	31	LPG 5
Cougar 2.5 V6		2.5	125	08.98 - 01.01	LCBC Duratec VE SEFI	6	1,0	PTR5D-10	3784	31	LPG 5
Cougar 2.5 V6		2.5	125	08.98 - 01.01	LCBE Duratec-VE SEFI	6	1,0	PTR5D-10	3784	31	LPG 5
Cougar 2.5 V6		2.5	151	08.98 - 01.01	MABB Duratec VE SEFI	6	1,0	PTR5D-10	3784	31	LPG 5

**COURIER**

Courier 11.8 D		1.8	66	03.93 -		4		Y-910R	4751	3	
----------------	--	-----	----	---------	--	---	--	--------	------	---	--

**ESCORT '91**

Escort '91 1.1		1.1	40	08.90 - 09.01	GUF HCS 2V	4	1,0	PTR5D-10	3784	31	LPG 5
Escort '91 1.3		1.3	44	08.90 - 09.01	J4B Endura-E SEFI	4	1,0	PTR5D-10	3784	31	LPG 5
Escort '91 1.3		1.3	44	08.90 - 09.01	J6A HCS CFI	4	1,0	PTR5D-10	3784	31	LPG 5
Escort '91 1.3		1.3	44	08.90 - 09.01	JBE HCS 2V	4	1,0	PTR5D-10	3784	31	LPG 5
Escort '91 1.3		1.3	46	08.90 - 09.01	JBD HCS 2V	4	1,0	PTR5D-10	3784	31	LPG 5
Escort '91 1.4		1.4	52	08.90 - 09.01	F6F CVH CFI	4	1,1	BCPR6ES-11	7121	11	LPG 3
Escort '91 1.4		1.4	52	08.90 - 09.01	F6G CVH CFI	4	1,1	BCPR6ES-11	7121	11	LPG 3
Escort '91 1.4		1.4	54	08.90 - 09.01	F4B PTE SEFI	4	1,1	BCPR6ES-11	7121	11	LPG 3
Escort '91 1.4		1.4	54	08.90 - 09.01	FUH CVH 2V	4	0,8	BCPR6ES	2330	12	LPG 3
Escort '91 1.6		1.6	65	08.90 - 09.01	L1H ZETEC-E SEFI	4	1,3	PTR5A-13	2467	25	LPG 4
Escort '91 1.6		1.6	66	08.90 - 09.01	L1E ZETEC-E SEFI	4	1,3	PTR5A-13	2467	25	LPG 4
Escort '91 1.6		1.6	66	08.90 - 09.01	L1K ZETEC-E SEFI	4	1,3	PTR5A-13	2467	25	LPG 4
Escort '91 1.6		1.6	66	08.90 - 09.01	LUJ CVH 2V	4	0,8	BCPR6ES	2330	12	LPG 3
Escort '91 1.6		1.6	66	08.90 - 09.01	LUK CVH 2V	4	0,8	BCPR6ES	2330	12	LPG 3
Escort '91 1.6		1.6	77	08.90 - 09.01	LJF CVH EFI	4	1,1	BCPR6ES-11	7121	11	LPG 3
Escort '91 1.6		1.6	79	08.90 - 09.01	LJE CVH EFI	4	1,1	BCPR6ES-11	7121	11	LPG 3
Escort '91 1.8 D		1.8	44	08.90 - 09.01	RTE	4		Y-910R	4751	3	
Escort '91 1.8 D		1.8	44	08.90 - 09.01	RTF	4		Y-910R	4751	3	
Escort '91 1.8 D		1.8	44	08.90 - 09.01	RTH	4		Y-910R	4751	3	
Escort '91 1.8 D		1.8	51	08.90 - 09.01	RVA Endura-DE (TC)	4		Y-937J	5148	5	
Escort '91 1.8 TD		1.8	66	08.90 - 09.01	RFD	4		Y-910R	4751	3	
Escort '91 1.8 TD		1.8	66	08.90 - 09.01	RFK	4		Y-910R	4751	3	
Escort '91 1.8 TD		1.8	66	08.90 - 09.01	RFS Endura-DE (TC)	4		Y-937J	5148	5	
Escort '91 1.8		1.8	77	08.90 - 09.01	RDA ZETEC SEFI	4	1,3	PTR5A-13	2467	25	LPG 4
Escort '91 1.8		1.8	85	08.90 - 09.01	RKC ZETEC-E SEFI	4	1,3	PTR5A-13	2467	25	LPG 4
Escort '91 1.8		1.8	96	08.90 - 09.01	RQB ZETEC SEFI	4	1,3	PTR5A-13	2467	25	LPG 4
Escort '91 2.0 RS 2000		2.0	110	08.90 - 09.01	N7A DOHC 16V EFI	4	1,1	BCPR6ES-11	7121	11	LPG 3
Escort '91 Cosworth		2.0	162	08.90 - 09.01	N5F DOHC COSWORTH	4	0,6	PFR7B	4853		PFR8B
Escort '91 Cosworth		2.0	162	08.90 - 09.01	N5E DOHC COSWORTH	4	1,1	PFR7B-11	5667		PFR8B
Escort '91 Cosworth		2.0	184	92 -	NC8 1711 COSWORTH 16V	4	0,8	R7234-10	5558		

**EXPLORER**

Explorer 4.0		4.0	115	01.93 - 03	V6 SEFI	6	1,5	TR55	3951		LPG 5
Explorer 4.0		4.0	121	01.93 - 03	V6 EFI	6	1,5	TR55	3951		LPG 5
Explorer 4.0		4.0	152	01.93 - 03	V6 SOHC SEFI	6	1,5	TR55	3951		LPG 5
Explorer 5.0		5.0		01.97 - 01	V8	8	1,5	TR55	3951		LPG 5



Code *l* kW

Cyl.

Stock-No.  
**VENE**  
BY-PROMOTER

LPG/CNG

**FORD****FIESTA '89**

Fiesta '89 1.0	GFJ	1.0	33	03.89 - 06.96	TLB HCS 1V	4	1,0	BPR6EFS	3623	7	LPG 5
Fiesta '89 1.1	GFJ	1.1	37	03.89 - 06.96	G6A HCS CFI	4	1,0	BPR6EFS	3623	7	LPG 5
Fiesta '89 1.1	GFJ	1.1	40	03.89 - 06.96	GUD HCS 2V	4	1,0	BPR6EFS	3623	7	LPG 5
Fiesta '89 1.1	GFJ	1.1	40	03.89 - 06.96	GUE HCS 2V	4	1,0	BPR6EFS	3623	7	LPG 5
Fiesta '89 1.3	GFJ	1.3	44	03.89 - 06.96	J6B HCS CFI	4	1,0	BPR6EFS	3623	7	LPG 5
Fiesta '89 1.3	GFJ	1.3	44	03.89 - 06.96	JBC HCS 2V	4	1,0	BPR6EFS	3623	7	LPG 5
Fiesta '89 1.4	GFJ	1.4	52	03.89 - 06.96	F6E CVH CFI	4	1,1	BCPR6ES-11	7121	11	LPG 3
Fiesta '89 1.4	GFJ	1.4	54	03.89 - 06.96	F4A PTE SEFI	4	1,1	BCPR6ES-11	7121	11	LPG 3
Fiesta '89 1.4	GFJ	1.4	54	03.89 - 06.96	FUG CVH 2V	4	1,1	BCPR6ES-11	7121	11	LPG 3
Fiesta '89 1.4	GFJ	1.4	54	03.89 - 06.96	FUJ CVH 2V	4	0,8	BCPR6ES	2330	12	LPG 3
Fiesta '89 1.4	GFJ	1.4	55	03.89 - 06.96	FUF CVH 2V	4	0,8	BCPR6ES	2330	12	LPG 3
Fiesta '89 1.6	GFJ	1.6	66	03.89 - 06.96	L1G ZETEC SEFI	4	1,3	PTR5A-13	2467	25	LPG 4
Fiesta '89 1.6	GFJ	1.6	66	03.89 - 06.96	LUH CVH 2V	4	0,8	BCPR6ES	2330	12	LPG 3
Fiesta '89 1.6 XR2i	GFJ	1.6	76	03.89 - 06.96	LJD CVH EFI	4	1,1	BCPR6ES-11	7121	11	LPG 3
Fiesta '89 1.6 XR2i	GFJ	1.6	81	03.89 - 06.96	LJC CVH EFI	4	1,1	BCPR6ES-11	7121	11	LPG 3
Fiesta '89 1.6 Turbo	GFJ	1.6	96	03.89 - 06.96	LHA CVH Turbo	4	0,8	BCR8ES	5430		
Fiesta '89 1.8 D	GFJ	1.8	44	03.89 - 06.96	RTC D	4	▣	Y-910R	4751	3	
Fiesta '89 1.8 D	GFJ	1.8	44	03.89 - 06.96	RTD D	4	▣	Y-910R	4751	3	
Fiesta '89 1.8 D	GFJ	1.8	44	03.89 - 06.96	RTG D	4	▣	Y-910R	4751	3	
Fiesta '89 1.8 16V	GFJ	1.8	77	03.89 - 06.96	RDB ZETEC SEFI	4	1,3	PTR5A-13	2467	25	LPG 4
Fiesta '89 1.8 XR2i	GFJ	1.8	96	03.89 - 06.96	RQC ZETEC SEFI	4	1,3	PTR5A-13	2467	25	LPG 4

**FIESTA '96**

Fiesta '96 1.25	JA / JB	1.25	55	11.95 - 02.02	DHA ZETEC-SE SEFI	4	1,3	PTR5A-13	2467	25	LPG 4
Fiesta '96 1.25	JA / JB	1.25	55	11.95 - 02.02	DHB ZETEC-SE SEFI	4	1,3	PTR5A-13	2467	25	LPG 4
Fiesta '96 1.25	JA / JB	1.25	55	11.95 - 02.02	DHC ZETEC-SE SEFI	4	1,3	PTR5A-13	2467	25	LPG 4
Fiesta '96 1.25	JA / JB	1.25	55	11.95 - 02.02	DHD ZETEC-SE SEFI	4	1,3	PTR5A-13	2467	25	LPG 4
Fiesta '96 1.25	JA / JB	1.25	55	11.95 - 02.02	DHE ZETEC-SE SEFI	4	1,3	PTR5A-13	2467	25	LPG 4
Fiesta '96 1.25	JA / JB	1.25	55	11.95 - 02.02	DHF ZETEC-SE SEFI	4	1,3	PTR5A-13	2467	25	LPG 4
Fiesta '96 1.25	JA / JB	1.25	55	11.95 - 02.02	DHG ZETEC-SE SEFI	4	1,3	PTR5A-13	2467	25	LPG 4
Fiesta '96 1.3	JA / JB	1.3	37	11.95 - 02.02	JJA Endura-E SEFI	4	1,0	PTR5D-10	3784	31	LPG 5
Fiesta '96 1.3	JA / JB	1.3	37	11.95 - 02.02	JJC Endura-E SEFI	4	1,0	PTR5D-10	3784	31	LPG 5
Fiesta '96 1.3	JA / JB	1.3	37	11.95 - 02.02	JJE Endura-E SEFI	4	1,0	PTR5D-10	3784	31	LPG 5
Fiesta '96 1.3	JA / JB	1.3	37	11.95 - 02.02	JJJ Endura-E SEFI	4	1,0	PTR5D-10	3784	31	LPG 5
Fiesta '96 1.3	JA / JB	1.3	37	11.95 - 02.02	JJK Endura-E SEFI	4	1,0	PTR5D-10	3784	31	LPG 5
Fiesta '96 1.3	JA / JB	1.3	37	11.95 - 02.02	JJM Endura-E SEFI	4	1,0	PTR5D-10	3784	31	LPG 5
Fiesta '96 1.3	JA / JB	1.3	44	11.95 - 02.02	J4C Endura-E SEFI	4	1,0	PTR5D-10	3784	31	LPG 5
Fiesta '96 1.3	JA / JB	1.3	44	11.95 - 02.02	J4J Endura-E SEFI	4	1,0	PTR5D-10	3784	31	LPG 5
Fiesta '96 1.3	JA / JB	1.3	44	11.95 - 02.02	J4L Endura-E SEFI	4	1,0	PTR5D-10	3784	31	LPG 5
Fiesta '96 1.3	JA / JB	1.3	44	11.95 - 02.02	J4Q Endura-E SEFI	4	1,0	PTR5D-10	3784	31	LPG 5
Fiesta '96 1.3	JA / JB	1.3	44	11.95 - 02.02	J4R Endura-E SEFI	4	1,0	PTR5D-10	3784	31	LPG 5
Fiesta '96 1.3	JA / JB	1.3	44	11.95 - 02.02	J4T Endura-E SEFI	4	1,0	PTR5D-10	3784	31	LPG 5
Fiesta '96 1.4 16V	JA / JB	1.4	66	11.95 - 02.02	FHA ZETEC-SE SEFI	4	1,3	PTR5A-13	2467	25	LPG 4
Fiesta '96 1.4 16V	JA / JB	1.4	66	11.95 - 02.02	FHE ZETEC-SE SEFI	4	1,3	PTR5A-13	2467	25	LPG 4
Fiesta '96 1.6 16V Sport	JA / JB	1.6	76	11.95 - 02.02	L1T ZETEC-SE SEFI	4	1,3	PTR5A-13	2467	25	LPG 4
Fiesta '96 1.6 16V Sport	JA / JB	1.6	76	11.95 - 02.02	L1V ZETEC-SE SEFI	4	1,3	PTR5A-13	2467	25	LPG 4
Fiesta '96 1.8 D	JA / JB	1.8	44	11.95 - 02.02	RTJ	4	▣	Y-937J	5148	5	
Fiesta '96 1.8 D	JA / JB	1.8	44	11.95 - 02.02	RTK	4	▣	Y-937J	5148	5	
Fiesta '96 1.8 DI	JA / JB	1.8	55	11.95 - 02.02	RTN	4	▣	Y-524J	4520	27	
Fiesta '96 1.8 DI	JA / JB	1.8	55	11.95 - 02.02	RTP	4	▣	Y-524J	4520	27	
Fiesta '96 1.8 DI	JA / JB	1.8	55	11.95 - 02.02	RTQ	4	▣	Y-524J	4520	27	

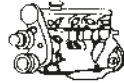
Code *l* kW

Cyl.



Stock-No.



LPG/CNG

**FORD  
FIESTA '01**

Fiesta '01 1.25	JH / JD	1.25	51	11.01 -	M7JA Duratec 16V SFI	4	1,3	PTR5A-13	2467	25	LPG 4
Fiesta '01 1.25	JH / JD	1.25	51	11.01 -	M7JB Duratec 16V SFI	4	1,3	PTR5A-13	2467	25	LPG 4
Fiesta '01 1.25	JH / JD	1.25	55	11.01 -	FUJA Duratec 16V SFI	4	1,3	PTR5A-13	2467	25	LPG 4
Fiesta '01 1.25	JH / JD	1.25	55	11.01 -	FUJB Duratec 16V SFI	4	1,3	PTR5A-13	2467	25	LPG 4
Fiesta '01 1.3	JH / JD	1.3	44	11.01 -	BAJA Duratec 8V SFI	4	1,3	TR5B-13	4559		LPG 4
Fiesta '01 1.3	JH / JD	1.3	51	11.01 -	A9JA Duratec 8V SFI	4	1,3	TR5B-13	4559		LPG 4
Fiesta '01 1.3	JH / JD	1.3	51	11.01 -	A9JB Duratec 8V SFI	4	1,3	TR5B-13	4559		LPG 4
Fiesta '01 1.4 TDCi	JH / JD	1.4	50	11.01 - 12.04	F6JA DuraTorq-TDCi	4	█	YE04	1684	40	
Fiesta '01 1.4 TDCi	JH / JD	1.4	50	11.01 - 12.04	F6JB DuraTorq-TDCi	4	█	YE04	1684	40	
Fiesta '01 1.4 TDCi	JH / JD	1.4	50	01.05 -	F6JA DuraTorq-TDCi	4	█	YE05	91322	73	
Fiesta '01 1.4 TDCi	JH / JD	1.4	50	01.05 -	F6JB DuraTorq-TDCi	4	█	YE05	91322	73	
Fiesta '01 1.4 16V	JH / JD	1.4	59	11.01 -	FXJA Duratec 16V SFI	4	1,3	PTR5A-13	2467	25	LPG 4
Fiesta '01 1.4 16V	JH / JD	1.4	59	11.01 -	FXJB Duratec 16V SFI	4	1,3	PTR5A-13	2467	25	LPG 4
Fiesta '01 1.6 TDCi	JH / JD	1.6	66	03.05 -	HHJA DuraTorq-TDCi	4	█	YE04	1684	40	
Fiesta '01 1.6 TDCi	JH / JD	1.6	66	03.05 -	HHJB DuraTorq-TDCi	4	█	YE04	1684	40	
Fiesta '01 1.6 16V	JH / JD	1.6	74	11.01 -	FYJB Duratec 16V SFI	4	1,3	PTR5A-13	2467	25	LPG 4
Fiesta '01 1.6 16V	JH / JD	1.6	74	11.01 -	FYJA Duratec 16V SFI	4	1,3	PTR5A-13	2467	25	LPG 4
Fiesta '01 2.0 ST 150	JH / JD	2.0	110	03.05 -	N4JB Duratec-ST (M14) SFI	4	1,3	ITR6F13	4477		LPG 5

**FIESTA '08**

Fiesta '08 1.25	JDG / JDJ	1.25	44	08.08 -	STJA / STJB	4	1,3	TR5B-13	4559		LPG 4
Fiesta '08 1.25	JDG / JDJ	1.25	60	08.08 -	SNJA / SNJB	4	1,3	TR5B-13	4559		LPG 4
Fiesta '08 1.4 TDCi	JDG / JDJ	1.4	50	08.08 -	F6JB	4	█	YE05	91322	73	
Fiesta '08 1.4 TDCi	JDG / JDJ	1.4	51	07.10 -	F6JD / KVJA	4	█	YE05	91322	73	
Fiesta '08 1.4 LPG	JDG / JDJ	1.4	68	01.09 -	RTJA / RTJB	4	0,8	ILTR6H8G	96870		ILTR6H8G
Fiesta '08 1.4	JDG / JDJ	1.4	71	10.08 -	SPJA / SPJC	4	1,3	TR5B-13	4559		LPG 4
Fiesta '08 1.6 TDCi	JDG / JDJ	1.6	55	08.08 -	HHJF / UBJA	4	█	YE05	91322	73	
Fiesta '08 1.6 TDCi	JDG / JDJ	1.6	66	08.08 -	HHJC / HHJD	4	█	YE05	91322	73	
Fiesta '08 1.6 TDCi Norm EU V	JDG / JDJ	1.6	70	03.10 -	TZJA / TZJB	4	█	Y8001AS	8904	58	
Fiesta '08 1.6 Ti	JDG / JDJ	1.6	88	10.08 -	HXJA / HXJB	4	1,3	TR5B-13	4559		LPG 4
Fiesta '08 1.6 Ti	JDG / JDJ	1.6	99	12.10 -	U5JA	4	1,3	TR5B-13	4559		LPG 4

**FOCUS '98**

Focus '98 1.4 16V	DAW / DBW	1.4	55	08.98 - 12.04	FXDA ZETEC-SE SFI	4	1,3	PTR5A-13	2467	25	LPG 4
Focus '98 1.4 16V	DAW / DBW	1.4	55	08.98 - 12.04	FXDB ZETEC-SE SFI	4	1,3	PTR5A-13	2467	25	LPG 4
Focus '98 1.4 16V	DAW / DBW	1.4	55	08.98 - 12.04	FXDC ZETEC-SE SEFI	4	1,3	PTR5A-13	2467	25	LPG 4
Focus '98 1.4 16V	DAW / DBW	1.4	55	08.98 - 12.04	FXDD ZETEC-SE SFI	4	1,3	PTR5A-13	2467	25	LPG 4
Focus '98 1.6 16V	DAW / DBW	1.6	72	08.98 - 12.04	CDDA Duratec SFI	4	1,3	TR5B-13	4559		LPG 4
Focus '98 1.6 16V	DAW / DBW	1.6	74	08.98 - 12.04	FYDA ZETEC-SE SFI	4	1,3	PTR5A-13	2467	25	LPG 4
Focus '98 1.6 16V	DAW / DBW	1.6	74	08.98 - 12.04	FYDB ZETEC-SE SFI	4	1,3	PTR5A-13	2467	25	LPG 4
Focus '98 1.6 16V	DAW / DBW	1.6	74	08.98 - 12.04	FYDC ZETEC-SE SFI	4	1,3	PTR5A-13	2467	25	LPG 4
Focus '98 1.6 16V	DAW / DBW	1.6	74	08.98 - 12.04	FYDD ZETEC-SE SFI	4	1,3	PTR5A-13	2467	25	LPG 4
Focus '98 1.6 16V	DAW / DBW	1.6	74	08.98 - 12.04	FYDH ZETEC-SE SFI	4	1,3	PTR5A-13	2467	25	LPG 4
Focus '98 1.8 DI	DAW / DBW	1.8	55	08.98 - 12.04	BHDA Endura-DI	4	█	Y-524J	4520	27	
Focus '98 1.8 DI	DAW / DBW	1.8	55	08.98 - 12.04	BHDB Endura-DI	4	█	Y-524J	4520	27	
Focus '98 1.8 Turbo DI	DAW / DBW	1.8	66	08.98 - 12.04	C9DA Endura-DI	4	█	Y-524J	4520	27	
Focus '98 1.8 Turbo DI	DAW / DBW	1.8	66	08.98 - 12.04	C9DB Endura-DI	4	█	Y-524J	4520	27	
Focus '98 1.8 Turbo DI	DAW / DBW	1.8	66	08.98 - 12.04	C9DC Endura-DI	4	█	Y-524J	4520	27	
Focus '98 1.8 16V	DAW / DBW	1.8	74	08.98 - 12.04	FFDA DuraTorq-TDCi	4	█	Y-524J	4520	27	
Focus '98 1.8 16V	DAW / DBW	1.8	85	08.98 - 12.04	EYDB ZETEC-E SFI	4	1,3	PTR5A-13	2467	25	LPG 4
Focus '98 1.8 16V	DAW / DBW	1.8	85	08.98 - 12.04	EYDC ZETEC-E SFI	4	1,3	PTR5A-13	2467	25	LPG 4
Focus '98 1.8 16V	DAW / DBW	1.8	85	08.98 - 12.04	EYDD ZETEC-E SFI	4	1,3	PTR5A-13	2467	25	LPG 4

Code *l* kW

Cyl.

Stock-No.  
**VEFINE**  
BY FORD/VEFINE

LPG/CNG

**FORD****FOCUS '98**

Focus '98 1.8 16V	DAW / DBW	1.8	85	08.98 - 12.04	EYDE ZETEC-E SFI	4	1,3	PTR5A-13	2467	25	LPG 4
Focus '98 1.8 16V	DAW / DBW	1.8	85	08.98 - 12.04	EYDF ZETEC-E SFI	4	1,3	PTR5A-13	2467	25	LPG 4
Focus '98 1.8 16V	DAW / DBW	1.8	85	08.98 - 12.04	EYDG ZETEC-E SFI	4	1,0	TR5A-10	0005		LPG 4
Focus '98 1.8 16V	DAW / DBW	1.8	85	08.98 - 12.04	EYDI ZETEC-E SFI	4	1,0	TR5A-10	0005		LPG 4
Focus '98 1.8 16V	DAW / DBW	1.8	85	08.98 - 12.04	EYDJ ZETEC-E SFI	4	1,0	TR5A-10	0005		LPG 4
Focus '98 1.8 16V	DAW / DBW	1.8	85	08.98 - 12.04	EYDL ZETEC-E SFI	4	1,0	TR5A-10	0005		LPG 4
Focus '98 1.8 TDCi	DAW / DBW	1.8	85	08.98 - 12.04	F9DB DuraTorq-TDCi	4		Y-524J	4520	27	
Focus '98 1.8 16V RUS	DAW / DBW	1.8	85	08.98 - 12.04	EYDK ZETEC-E EFI	4	1,3	PTR5A-13	2467	25	LPG 4
Focus '98 1.8 TDCi	DAW / DBW	1.8	85	08.98 - 12.04	F9DA DuraTorq-TDCi	4		Y-524J	4520	27	
Focus '98 2.0 16V	DAW / DBW	2.0	96	08.98 - 12.04	EDDB ZETEC-E SFI	4	1,3	PTR5A-13	2467	25	LPG 4
Focus '98 2.0 16V	DAW / DBW	2.0	96	08.98 - 12.04	EDDC ZETEC-E SFI	4	1,3	PTR5A-13	2467	25	LPG 4
Focus '98 2.0 16V	DAW / DBW	2.0	96	08.98 - 12.04	EDDD ZETEC-E SFI	4	1,3	PTR5A-13	2467	25	LPG 4
Focus '98 2.0 16V	DAW / DBW	2.0	96	08.98 - 12.04	EDDF ZETEC-E SFI	4	1,3	PTR5A-13	2467	25	LPG 4
Focus '98 2.0 RS Turbo	DAW / DBW	2.0	158	10.02 - 12.04	HMDA Duratec RS SFI	4	1,0	PLTR6A-10G	3587		PLTR6A-10G

**FOCUS '02**

Focus / C-Max 1.6 TDCi	DAW / DBW	1.6	66	06.03 -	HHDA DuraTorq-TDCi	4		YE04	1684	40	
Focus / C-Max 1.6 TDCi	DAW / DBW	1.6	66	06.03 -	HHDB DuraTorq-TDCi	4		YE04	1684	40	
Focus / C-Max 1.6	DAW / DBW	1.6	74	06.03 -	HWDA Duratec-16V SFI	4	1,3	TR5B-13	4559		LPG 4
Focus / C-Max 1.6	DAW / DBW	1.6	74	06.03 -	HWDB Duratec-16V SFI	4	1,3	TR5B-13	4559		LPG 4
Focus / C-Max 1.6	DAW / DBW	1.6	74	06.03 -	SHDA Duratec-HE SFI	4	1,3	TR5B-13	4559		LPG 4
Focus / C-Max 1.6	DAW / DBW	1.6	74	06.03 -	SHDB Duratec-HE SFI	4	1,3	TR5B-13	4559		LPG 4
Focus / C-Max 1.6 TDCi	DAW / DBW	1.6	80	06.03 -	G8DA DuraTorq-TDCi	4		YE04	1684	40	
Focus / C-Max 1.6 TDCi	DAW / DBW	1.6	80	06.03 -	G8DB DuraTorq-TDCi	4		YE04	1684	40	
Focus / C-Max 1.6 Ti	DAW / DBW	1.6	85	06.03 -	HXDA Duratec-16V Ti-VCT	4	1,3	TR5B-13	4559		LPG 4
Focus / C-Max 1.6 Ti	DAW / DBW	1.6	85	06.03 -	HXDB Duratec-HE SFI	4	1,3	TR5B-13	4559		LPG 4
Focus / C-Max 1.8	DAW / DBW	1.8	88	06.03 -	CSDA Duratec-HE SFI	4	1,3	ITR6F13	4477		LPG 5
Focus / C-Max 1.8	DAW / DBW	1.8	88	06.03 -	CSDB Duratec-HE SFI	4	1,3	ITR6F13	4477		LPG 5
Focus / C-Max 1.8	DAW / DBW	1.8	92	06.03 -	QQDA Duratec-HE SFI	4	1,3	TR6AP-13	5809		LPG 5
Focus / C-Max 1.8	DAW / DBW	1.8	92	06.03 -	QQDB Duratec-HE SFI	4	1,3	TR6AP-13	5809		LPG 5
Focus / C-Max 1.8	DAW / DBW	1.8	92	06.03 -	QQDC Duratec-HE SFI	4	1,3	TR6AP-13	5809		LPG 5
Focus / C-Max 1.8 Flexifuel	DAW / DBW	1.8	92	06.03 -	Q7DA Duratec-HE SFI	4	1,3	TR6AP-13	5809		LPG 5
Focus / C-Max 2.0 TDCi	DAW / DBW	2.0	98	06.03 -	G6DC DuraTorq-TDCi	4		Y1005J	7957	56	
Focus / C-Max 2.0 TDCi	DAW / DBW	2.0	98	06.03 -	G6DE DuraTorq-TDCi	4		Y1005J	7957	56	
Focus / C-Max 2.0 TDCi	DAW / DBW	2.0	98	06.03 -	G6DF DuraTorq-TDCi	4		Y1005J	7957	56	
Focus / C-Max 2.0 TDCi	DAW / DBW	2.0	100	06.03 -	G6DA	4		Y1005J	7957	56	
Focus / C-Max 2.0 TDCi	DAW / DBW	2.0	100	06.03 -	G6DB	4		Y1005J	7957	56	
Focus / C-Max 2.0 TDCi	DAW / DBW	2.0	100	06.03 -	G6DD	4		Y1005J	7957	56	
Focus / C-Max 2.0	DAW / DBW	2.0	107	04.04 - 03.07	AODA Duratec-HE SFI	4	1,3	TR6AP-13	5809		LPG 5
Focus / C-Max 2.0	DAW / DBW	2.0	107	04.04 - 03.07	AODB Duratec-HE SFI	4	1,3	TR6AP-13	5809		LPG 5
Focus / C-Max 2.0 LPG / CNG	DAW / DBW	2.0	107	04.04 - 03.07	SYDA Duratec-HE SFI	4	1,3	TR6AP-13	5809		LPG 5
Focus ST 170	DAW / DBW	2.0	127	03.02 - 11.04	ALDA Duratec-ST	4	1,0	PLTR6A-10G	3587		PLTR6A-10G

**FOCUS '04**

Focus '04 1.4	DA / DAW	1.4	59	07.04 -	ASDA Duratec-16V SFI	4	1,3	TR5B-13	4559		LPG 4
Focus '04 1.4	DA / DAW	1.4	59	07.04 -	ASDB Duratec-16V SFI	4	1,3	TR5B-13	4559		LPG 4
Focus '04 1.6 TDCi	DA / DAW	1.6	66	07.04 -	HHDA DuraTorq-TDCi	4		YE04	1684	40	
Focus '04 1.6 TDCi	DA / DAW	1.6	66	07.04 -	HHDB DuraTorq-TDCi	4		YE04	1684	40	
Focus '04 1.6	DA / DAW	1.6	74	07.04 -	HWDA Duratec-16V SFI	4	1,3	TR5B-13	4559		LPG 4
Focus '04 1.6	DA / DAW	1.6	74	07.04 -	HWDB Duratec-16V SFI	4	1,3	TR5B-13	4559		LPG 4
Focus '04 1.6	DA / DAW	1.6	74	07.04 -	SHDA Duratec-16V SFI	4	1,3	TR5B-13	4559		LPG 4

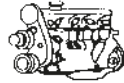
Code *l* kW

Cyl.

Stock-No.  
**VALUE**  
10-15-2015/2016

LPG/CNG

**FORD  
FOCUS '04**

Focus '04 1.6	DA / DAW	1.6	74	07.04 -	SHDB Duratec-16V SFI	4	1,3	TR5B-13	4559		LPG 4
Focus '04 1.6 TDCi	DA / DAW	1.6	80	07.04 -	G8DA DuraTorq-TDCi	4	█	YE04	1684	40	
Focus '04 1.6 TDCi	DA / DAW	1.6	80	07.04 -	G8DB DuraTorq-TDCi	4	█	YE04	1684	40	
Focus '04 1.6 Ti	DA / DAW	1.6	85	07.04 -	HXDA Duratec-16V Ti-VCT	4	1,3	TR5B-13	4559		LPG 4
Focus '04 1.6 Ti	DA / DAW	1.6	85	07.04 -	HXDB Duratec-16V Ti-VCT	4	1,3	TR5B-13	4559		LPG 4
Focus '04 1.8 TDCi	DA / DAW	1.8	85	07.04 -	KKDA / KKDB	4	█	Y-524J	4520	27	
Focus '04 1.8	DA / DAW	1.8	92	07.04 -	Q7DA Duratec-HE SFI	4	1,3	TR6AP-13	5809		LPG 5
Focus '04 1.8	DA / DAW	1.8	92	07.04 -	QQDB Duratec-HE SFI	4	1,3	TR6AP-13	5809		LPG 5
Focus '04 1.8	DA / DAW	1.8	92	06 -	QQDA Duratec-HE SFI	4	1,3	TR6AP-13	5809		LPG 5
Focus '04 1.8	DA / DAW	1.8	96	06 -	QQDD Duratec-HE SFI	4	1,3	TR6AP-13	5809		LPG 5
Focus '04 2.0 TDCi	DA / DAW	2.0	81	02.08 -	IXDA	4	█	Y1005J	7957	56	
Focus '04 2.0 CNG	DA / DAW	2.0	93	03.09 -	Duratec-HE SFI	4	1,3	TR6AP-13	5809		LPG 5
Focus '04 2.0 TDCi	DA / DAW	2.0	98	07.04 -	G6DC DuraTorq-TDCi	4	█	Y1005J	7957	56	
Focus '04 2.0 TDCi	DA / DAW	2.0	98	07.04 -	G6DE DuraTorq-TDCi	4	█	Y1005J	7957	56	
Focus '04 2.0 TDCi	DA / DAW	2.0	98	07.04 -	G6DF DuraTorq-TDCi	4	█	Y1005J	7957	56	
Focus '04 2.0 TDCi	DA / DAW	2.0	100	07.04 -	G6DA	4	█	Y1005J	7957	56	
Focus '04 2.0 TDCi	DA / DAW	2.0	100	07.04 -	G6DB	4	█	Y1005J	7957	56	
Focus '04 2.0 TDCi	DA / DAW	2.0	100	07.04 -	G6DD	4	█	Y1005J	7957	56	
Focus '04 2.0 CNG	DA / DAW	2.0	107	03.09 -	Duratec-HE SFI	4	1,3	TR6AP-13	5809		LPG 5
Focus '04 2.0 LPG	DA / DAW	2.0	107	03.09 -	Duratec-HE SFI	4	1,3	TR6AP-13	5809		LPG 5
Focus '04 2.0	DA / DAW	2.0	107	07.04 -	AODA Duratec-HE SFI	4	1,3	TR6AP-13	5809		LPG 5
Focus '04 2.0	DA / DAW	2.0	107	07.04 -	AODB Duratec-HE SFI	4	1,3	TR6AP-13	5809		LPG 5
Focus '04 2.0	DA / DAW	2.0	107	06 -	SYDA Duratec-HE SFI	4	1,3	TR6AP-13	5809		LPG 5
Focus '04 2.5 ST	DA / DAW	2.5	166	12.05 -	HYDA	5	0,8	PLFR6A	5472		LPG 7

**FOCUS '11**

Focus '11 1.6 Ti-VCT	DYM	1.6	63	08.11 -	XTDA	4	1,3	TR5B-13	4559		LPG 4
Focus '11 1.6 TDCi Norm EU V	DYM	1.6	70	04.11 -	T3DA / T3DB	4	█	Y8001AS	8904	58	
Focus '11 1.6 Ti-VCT	DYM	1.6	77	04.11 -	IQDA / IQDB	4	1,3	TR5B-13	4559		LPG 4
Focus '11 1.6 TDCi Norm EU V	DYM	1.6	85	04.11 -	T1DA / T1DB	4	█	Y8001AS	8904	58	
Focus '11 1.6 Flexifuel	DYM	1.6	88	04.11 -	MUDA	4	1,3	TR5B-13	4559		LPG 4
Focus '11 1.6 Ti-VCT	DYM	1.6	92	04.11 -	PNDA	4	1,3	TR5B-13	4559		LPG 4
Focus '11 1.6 EcoBoost	DYM	1.6	110	04.11 -	JQDA / JQDB	4	0,8	ILZTR6A8G	94769		
Focus '11 1.6 EcoBoost	DYM	1.6	134	04.11 -	JTDA / JTDB	4	0,8	ILZTR6A8G	94769		
Focus '11 2.0 TDCi Norm EU V	DYM	2.0	85	04.11 -	TYDA	4	█	Y8001AS	8904	58	
Focus '11 2.0 TDCi Norm EU V	DYM	2.0	100	04.11 -	UKDB	4	█	Y8001AS	8904	58	
Focus '11 2.0 TDCi Norm EU V	DYM	2.0	103	04.11 -	UFDB	4	█	Y8001AS	8904	58	
Focus '11 2.0 TDCi Norm EU V	DYM	2.0	120	04.11 -	TXDB	4	█	Y8001AS	8904	58	

**FOCUS C-MAX '11**

Focus C-Max '11 1.6 Ti-VCT	BJ	1.6	63	09.11 -	XTDA	4	1,3	TR5B-13	4559		LPG 4
Focus C-Max '11 1.6 TDCi Norm EU V	BJ	1.6	70	12.10 -	T3DA / T3DB	4	█	Y8001AS	8904	58	
Focus C-Max '11 1.6	BJ	1.6	77	12.10 -	IQDA / IQDB	4	1,3	TR5B-13	4559		LPG 4
Focus C-Max '11 1.6 TDCi Norm EU V	BJ	1.6	85	12.10 -	T1DA / T1DB	4	█	Y8001AS	8904	58	
Focus C-Max '11 1.6	BJ	1.6	92	12.10 -	PNDA	4	1,3	TR5B-13	4559		LPG 4
Focus C-Max '11 1.6 EcoBoost	BJ	1.6	110	12.10 -	JQDA / JQDB	4	0,8	ILZTR6A8G	94769		
Focus C-Max '11 1.6 EcoBoost	BJ	1.6	134	12.10 -	JTDA / JTDB	4	0,8	ILZTR6A8G	94769		
Focus C-Max '11 2.0 TDCi Norm EU V	BJ	2.0	85	02.11 -	TYDA	4	█	Y8001AS	8904	58	
Focus C-Max '11 2.0 TDCi Norm EU V	BJ	2.0	100	02.11 -	UKDB	4	█	Y8001AS	8904	58	



Code *l* kW

Cyl.

Stock-No.  
**VEINE**  
E-FORWARD

LPG/CNG

**FORD****FOCUS C-MAX '11**

Focus C-Max '11 2.0 TDCi Norm EU V	BJ	2.0	103	02.11 -	UFDA	4	☑	Y8001AS	8904	58	
Focus C-Max '11 2.0 TDCi Norm EU V	BJ	2.0	120	12.10 -	TXDB	4	☑	Y8001AS	8904	58	

**FUSION**

Fusion 1.25	JU	1.25	55	06.02 -	FUJA Duratec 16V SFI	4	1,3	PTR5A-13	2467	25	LPG 4
Fusion 1.25	JU	1.25	55	06.02 -	FUJB Duratec 16V SFI	4	1,3	PTR5A-13	2467	25	LPG 4
Fusion 1.4 TDCi	JU	1.4	50	06.02 - 12.04	F6JA DuraTorq-TDCi	4	☑	YE04	1684	40	
Fusion 1.4 TDCi	JU	1.4	50	06.02 - 12.04	F6JB DuraTorq-TDCi	4	☑	YE04	1684	40	
Fusion 1.4 TDCi	JU	1.4	50	01.05 -	F6JA DuraTorq-TDCi	4	☑	YE05	91322	73	
Fusion 1.4 TDCi	JU	1.4	50	01.05 -	F6JB DuraTorq-TDCi	4	☑	YE05	91322	73	
Fusion 1.4	JU	1.4	59	06.02 -	FXJA Duratec 16V SFI	4	1,3	PTR5A-13	2467	25	LPG 4
Fusion 1.4	JU	1.4	59	06.02 -	FXJB Duratec 16V SFI	4	1,3	PTR5A-13	2467	25	LPG 4
Fusion 1.6 TDCi	JU	1.6	66	06.02 -	HHJA DuraTorq-TDCi	4	☑	YE04	1684	40	
Fusion 1.6 TDCi	JU	1.6	66	06.02 -	HHJB DuraTorq-TDCi	4	☑	YE04	1684	40	
Fusion 1.6	JU	1.6	74	06.02 -	FYJA Duratec 16V SFI	4	1,3	PTR5A-13	2467	25	LPG 4
Fusion 1.6	JU	1.6	74	06.02 -	FYJB Duratec 16V SFI	4	1,3	PTR5A-13	2467	25	LPG 4

**GALAXY '95**

Galaxy 1.9 TDI	WGR	1.9	66	02.95 - 02.96	1Z	4	☑	Y-732J	5605	4	
Galaxy 1.9 TDI	WGR	1.9	66	02.95 - 03.00	ANU	4	☑	Y-732J	5605	4	
Galaxy 1.9 TDI	WGR	1.9	66	03.96 - 03.00	1Z	4	☑	Y-732J	5605	4	
Galaxy 1.9 TDI	WGR	1.9	66	09.96 - 03.00	AHU	4	☑	Y-732J	5605	4	
Galaxy 1.9 TDI	WGR	1.9	81	02.95 - 08.99	AFN	4	☑	Y-732J	5605	4	
Galaxy 1.9 TDI	WGR	1.9	81	09.99 - 03.00	AVG	4	☑	Y-732J	5605	4	
Galaxy 1.9 TDI	WGR	1.9		06.95 -	AJM	4	☑	Y-732J	5605	4	
Galaxy 2.0	WGR	2.0	85	02.95 - 03.00	NSE DOHC SEFI	4	1,1	BKR7EVX-11	4685		BKR8EIX
Galaxy 2.3 16V	WGR	2.3	107	02.95 - 03.00	Y5B DOHC 16V SEFI	4	1,1	BKR6EVX-11	3540		LPG 1
Galaxy 2.8 VR6 4x4	WGR	2.8	128	02.95 - 03.98	AAA CD V6 SEFI	6		BKR5EKUP	2890		
Galaxy 2.8 VR6 4x4	WGR	2.8	128	04.98 - 03.00	AMY CD V6 SEFI	6		BKR5EKUP	2890		

**GALAXY 2000**

Galaxy 1.9 TDI	WGR	1.9	66	04.00 - 02.06	ANU	4	☑	Y-732J	5605	4	
Galaxy 1.9 TDI	WGR	1.9	85	04.00 - 02.06	AUY	4	☑	Y-732J	5605	4	
Galaxy 1.9 TDI	WGR	1.9	96	04.00 - 02.06	ASZ	4	☑	Y-732J	5605	4	
Galaxy 1.9 TDI	WGR	1.9	110	04.00 - 02.06	BTB	4	☑	Y-732J	5605	4	
Galaxy 2.0	WGR	2.0	85	04.00 - 02.06	ZVSA DOHC SEFI	4	1,1	BKR7EVX-11	4685		BKR8EIX
Galaxy 2.3 16V	WGR	2.3	103	04.00 - 02.06	E5SB DOHC 16V SEFI	4	1,1	BKR6EVX-11	3540		LPG 1
Galaxy 2.3 16V	WGR	2.3	107	04.00 - 02.06	E5SA DOHC 16V SEFI	4	1,1	BKR6EVX-11	3540		LPG 1
Galaxy 2.8 24V	WGR	2.8	150	04.00 - 02.06	AYL CD V6 24V SEFI	6	1,1	PZFR5D-11	7968	34	LPG 6

**GALAXY '06**

Galaxy '06 1.6 TDCi Norm EU V	WM	1.6	85	02.11 -	T1WA / T1WB	4	☑	Y8001AS	8904	58	
Galaxy '06 1.6 EcoBoost	WM	1.6	118	02.11 -	JTWA / JTWB	4	0,8	ILZTR6A8G	94769		
Galaxy '06 1.8 TDCi	WM	1.8	74	05.06 -	FFWA	4	☑	Y-524J	4520	27	
Galaxy '06 2.0 TDCi	WM	2.0	85	11.07 -	KLWA	4	☑	Y1005J	7957	56	
Galaxy '06 2.0 TDCi	WM	2.0	85	11.07 -	TYWA	4	☑	Y8001AS	8904	58	
Galaxy '06 2.0 TDCi	WM	2.0	96	05.06 -	AZWA	4	☑	Y1005J	7957	56	
Galaxy '06 2.0 TDCi	WM	2.0	100	04.06 -	AZWC / UKWA	4	☑	Y8001AS	8904	58	
Galaxy '06 2.0 TDCi	WM	2.0	103	05.06 -	QXWA / QXWB / QXWC	4	☑	Y1005J	7957	56	
Galaxy '06 2.0 TDCi	WM	2.0	103	05.06 -	UFWA	4	☑	Y8001AS	8904	58	
Galaxy '06 2.0	WM	2.0	107	05.06 -	AOWA / AOWB	4	1,3	TR6AP-13	5809		LPG 5
Galaxy '06 2.0 Flexifuel	WM	2.0	107	05.06 -	TBWA / TBWB	4	1,3	TR6AP-13	5809		LPG 5

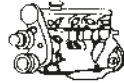
Code *l* kW

Cyl.



Stock-No.



LPG/CNG

**FORD GALAXY '06**

Galaxy '06 2.0 TDCi Norm EU V	WM	2.0	120	03.10 -	TXWA	4		Y8001AS	8904	58	
Galaxy '06 2.2 TDCi	WM	2.2	129	03.08 -	Q4BA / Q4WA	4		YE08	4966		
Galaxy '06 2.2 TDCi	WM	2.2	147	07.10 -		4		YE08	4966		
Galaxy '06 2.3	WM	2.3	118	07.07 -	SEWA	4	1,3	ILTR5A-13G	3811		ILTR6A-13G

**KA '96**

Ka '96 1.3	RB	1.3	36	09.96 -	JJD Endura-E SEFI	4	1,0	PTR5D-10	3784	31	LPG 5
Ka '96 1.3	RB	1.3	36	09.96 -	JJF Endura-E SEFI	4	1,0	PTR5D-10	3784	31	LPG 5
Ka '96 1.3	RB	1.3	36	09.96 -	JJG Endura-E SEFI	4	1,0	PTR5D-10	3784	31	LPG 5
Ka '96 1.3	RB	1.3	36	09.96 -	JJH Endura-E SEFI	4	1,0	PTR5D-10	3784	31	LPG 5
Ka '96 1.3	RB	1.3	36	09.96 -	JJL Endura-E SEFI	4	1,0	PTR5D-10	3784	31	LPG 5
Ka '96 1.3	RB	1.3	37	09.96 -	JJB Endura-E SEFI	4	1,0	PTR5D-10	3784	31	LPG 5
Ka '96 1.3	RB	1.3	44	09.96 -	BAA Duratec 8V SFI	4	1,3	TR5B-13	4559		LPG 4
Ka '96 1.3	RB	1.3	44	09.96 -	J4D Endura-E SEFI	4	1,0	PTR5D-10	3784	31	LPG 5
Ka '96 1.3	RB	1.3	44	09.96 -	J4K Endura-E SEFI	4	1,0	PTR5D-10	3784	31	LPG 5
Ka '96 1.3	RB	1.3	44	09.96 -	J4M Endura-E SEFI	4	1,0	PTR5D-10	3784	31	LPG 5
Ka '96 1.3	RB	1.3	44	09.96 -	J4N Endura-E SEFI	4	1,0	PTR5D-10	3784	31	LPG 5
Ka '96 1.3	RB	1.3	44	09.96 -	J4P Endura-E SEFI	4	1,0	PTR5D-10	3784	31	LPG 5
Ka '96 1.3	RB	1.3	44	09.96 -	J4S Endura-E SEFI	4	1,0	PTR5D-10	3784	31	LPG 5
Ka '96 1.3	RB	1.3	51	09.96 -	A9A Duratec 8V SFI	4	1,3	TR5B-13	4559		LPG 4
Ka '96 1.3	RB	1.3	51	09.96 -	A9B Duratec 8V SFI	4	1,3	TR5B-13	4559		LPG 4
Ka '96 1.6	RB	1.6	70	09.96 -	CDB Duratec 8V SFI	4	1,3	PTR5A-13	2467	25	LPG 4
Ka '96 1.6	RB	1.6	70	09.96 -	CDC Duratec 8V SFI	4	1,3	PTR5A-13	2467	25	LPG 4

**KA '08**

Ka '08 1.2	JDU	1.2	51	02.09 -	FP4	4	1,0	ZKR7A-10	1691		LPG 8
Ka '08 1.3 TDCi	JDU	1.3	55	02.09 - 10.10	FD4	4		Y8003J	97256	62	
Ka '08 1.3 TDCi	JDU	1.3	55	11.10 -	FD4	4		Y9001AS	97719	72	

**KUGA 1**

Kuga 1 2.0 TDCi	DR	2.0	100	03.08 -	G6DG / UKDA	4		Y1005J	7957	56	
Kuga 1 2.0 TDCi Norm EU V	DR	2.0	103	03.10 -	UFDA	4		Y8001AS	8904	58	
Kuga 1 2.0 TDCi	DR	2.0	120	03.10 -	DuraTorq-TDCi	4		Y1005J	7957	56	

**KUGA 2**

Kuga 2 1.6 EcoBoost	MA	1.6	110	11.12 -		4	0,8	ILZTR6A8G	94769		
Kuga 2 1.6 EcoBoost	MA	1.6	134	11.12 -		4	0,8	ILZTR6A8G	94769		
Kuga 2 2.0 TDCi	MA	2.0	103	11.12 -		4		Y8001AS	8904	58	
Kuga 2 2.0 TDCi	MA	2.0	120	11.12 -		4		Y8001AS	8904	58	

**MAVERICK '93**

Maverick '93 2.4	UDS / UNS	2.4	85	06.93 - 04.98	KA24 OHC 12V SEFI	4	1,1	ZFR5E-11	4435		
Maverick '93 2.4	UDS / UNS	2.4	87	06.93 - 04.98	KA24 OHC 12V SEFI	4	1,1	ZFR5E-11	4435		
Maverick '93 2.4	UDS / UNS	2.4	91	06.93 - 04.98	KA24 OHC 12V SEFI	4	1,1	ZFR5E-11	4435		
Maverick '93 2.7	UDS / UNS	2.7	74	04.93 - 04.98	TD27	4		Y-712RS	6140		
Maverick '93 2.7	UDS / UNS	2.7	92	05.96 - 04.98	TD27E	4		CY58	5486		

**MAVERICK '01**

Maverick '01 2.0 16V		2.0	91	12.00 - 11.03	YF ZETEC-E SFI	4	1,3	PTR5A-13	2467	25	LPG 4
Maverick '01 2.3 16V		2.3	110	12.03 -	GZ Duratec-HE SFI	4	1,3	ITR6F13	4477		LPG 5
Maverick '01 3.0		3.0	145	12.00 - 11.03	AJ Duratec-VE SFI	6	1,0	TR5IX	7397		LPG 5
Maverick '01 3.0		3.0	149	12.03 -	AJ Duratec-VE SFI	6	1,0	TR5IX	7397		LPG 5

Code *l* kW

Cyl.



Stock-No.



LPG/CNG

**FORD****MONDEO '93**

Mondeo '93 1.6		1.6	65	01.93 - 07.96	L1J ZETEC-E SEFI	4	1,3	PTR5A-13	2467	25	LPG 4
Mondeo '93 1.6		1.6	66	01.93 - 07.96	L1F ZETEC SEFI	4	1,3	PTR5A-13	2467	25	LPG 4
Mondeo '93 1.8 TD		1.8	65	01.93 - 07.96	RFM D TCI	4	█	Y-910J	3617	3	
Mondeo '93 1.8 TD		1.8	65	01.93 - 07.96	RFN D TCI	4	█	Y-910J	3617	3	
Mondeo '93 1.8		1.8	82	01.93 - 07.96	RKB ZETEC-E SEFI	4	1,3	PTR5A-13	2467	25	LPG 4
Mondeo '93 1.8		1.8	85	01.93 - 07.96	RKA ZETEC SEFI	4	1,3	PTR5A-13	2467	25	LPG 4
Mondeo '93 2.0		2.0	100	01.93 - 07.96	NGA ZETEC SEFI	4	1,3	PTR5A-13	2467	25	LPG 4
Mondeo '93 2.5 i 24V		2.5	125	01.93 - 07.96	SEA Duratec-VE SEFI	6	1,0	PTR5D-10	3784	31	LPG 5

**MONDEO '97**

Mondeo '97 1.6		1.6	65	08.96 - 09.00	L1J ZETEC-E SEFI	4	1,3	PTR5A-13	2467	25	LPG 4
Mondeo '97 1.6 16V		1.6	70	08.96 - 09.00	L1L ZETEC-E SEFI	4	1,3	PTR5A-13	2467	25	LPG 4
Mondeo '97 1.6 16V		1.6	70	08.96 - 09.00	L1N ZETEC-E SEFI	4	1,3	PTR5A-13	2467	25	LPG 4
Mondeo '97 1.6 16V		1.6	70	08.96 - 09.00	L1Q ZETEC-E SEFI	4	1,3	PTR5A-13	2467	25	LPG 4
Mondeo '97 1.8 TD		1.8	66	08.96 - 09.00	RFN Endura-De TCI	4	█	Y-937R	5148	5	
Mondeo '97 1.8		1.8	85	08.96 - 09.00	RKB ZETEC-E SEFI	4	1,3	PTR5A-13	2467	25	LPG 4
Mondeo '97 1.8		1.8	85	08.96 - 09.00	RKF ZETEC-E SEFI	4	1,3	PTR5A-13	2467	25	LPG 4
Mondeo '97 1.8		1.8	85	08.96 - 09.00	RKH ZETEC-E SEFI	4	1,3	PTR5A-13	2467	25	LPG 4
Mondeo '97 1.8		1.8	85	08.96 - 09.00	RKJ ZETEC-E SEFI	4	1,3	PTR5A-13	2467	25	LPG 4
Mondeo '97 1.8		1.8	85	08.96 - 09.00	RKK ZETEC-E SEFI	4	1,3	PTR5A-13	2467	25	LPG 4
Mondeo '97 2.0		2.0	96	08.96 - 09.00	NGA ZETEC-E SEFI	4	1,3	PTR5A-13	2467	25	LPG 4
Mondeo '97 2.0		2.0	96	08.96 - 09.00	NGB ZETEC-E SEFI	4	1,3	PTR5A-13	2467	25	LPG 4
Mondeo '97 2.0		2.0	96	08.96 - 09.00	NGC ZETEC-E SEFI	4	1,3	PTR5A-13	2467	25	LPG 4
Mondeo '97 2.0		2.0	96	08.96 - 09.00	NGD ZETEC-E SEFI	4	1,3	PTR5A-13	2467	25	LPG 4
Mondeo '97 2.5 24V		2.5	125	08.96 - 09.00	SEA Duratec-VE SEFI	6	1,0	PTR5D-10	3784	31	LPG 5
Mondeo '97 2.5 24V		2.5	125	08.96 - 09.00	SEB Duratec-VE SEFI	6	1,0	PTR5D-10	3784	31	LPG 5
Mondeo '97 2.5 24V		2.5	125	08.96 - 09.00	SEC Duratec-VE SEFI	6	1,0	PTR5D-10	3784	31	LPG 5
Mondeo '97 2.5 ST 200		2.5	151	08.96 - 09.00	SGA Duratec-VE SEFI	6	1,3	PTR6D-13G	6989		LPG 5

**MONDEO '01**

Mondeo '01 1.8 16V		1.8	81	10.00 - 8.07	CGBA Duratec-HE SFI	4	1,3	PTR6F-13	7569		LPG 5
Mondeo '01 1.8 16V		1.8	81	10.00 - 8.07	CGBB Duratec-HE SFI	4	1,3	PTR6F-13	7569		LPG 5
Mondeo '01 1.8 16V		1.8	92	10.00 - 8.07	CHBA Duratec-HE SFI	4	1,3	PTR6F-13	7569		LPG 5
Mondeo '01 1.8 16V		1.8	92	10.00 - 8.07	CHBB Duratec-HE SFI	4	1,3	PTR6F-13	7569		LPG 5
Mondeo '01 2.0 TDCi		2.0	66	10.00 - 8.07	D5BA DuraTorq-DI	4	█	Y-548J	94832	75	
Mondeo '01 2.0 TDCi		2.0	85	10.00 - 8.07	D6BA DuraTorq-DI	4	█	Y-548J	94832	75	
Mondeo '01 2.0 TDCi		2.0	85	10.00 - 8.07	HJBA DuraTorq-TDCi	4	█	Y-548J	94832	75	
Mondeo '01 2.0 TDCi		2.0	85	10.00 - 8.07	HJBB DuraTorq-TDCi	4	█	Y-548J	94832	75	
Mondeo '01 2.0 TDCi		2.0	85	10.00 - 8.07	HJBC DuraTorq-TDCi	4	█	Y-548J	94832	75	
Mondeo '01 2.0 TDCi		2.0	85	10.00 - 8.07	SDBA DuraTorq-TDCi	4	█	Y-548J	94832	75	
Mondeo '01 2.0 TDCi		2.0	96	10.00 - 8.07	FMBA DuraTorq-TDCi	4	█	Y-548J	94832	75	
Mondeo '01 2.0 TDCi		2.0	96	10.00 - 8.07	N7BA DuraTorq-TDCi	4	█	Y-548J	94832	75	
Mondeo '01 2.0 16V		2.0	107	10.00 - 8.07	CJBA Duratec-HE SFI	4	1,3	PTR6F-13	7569		LPG 5
Mondeo '01 2.0 16V		2.0	107	10.00 - 8.07	CJBB Duratec-HE SFI	4	1,3	PTR6F-13	7569		LPG 5
Mondeo '01 2.2 TDCi		2.2	110	09.04 - 8.07	QJBC DuraTorq-TDCi	4	█	Y-548J	94832	75	
Mondeo '01 2.2 TDCi		2.2	110	09.04 - 8.07	QJBD DuraTorq-TDCi	4	█	Y-548J	94832	75	
Mondeo '01 2.2 TDCi		2.2	114	09.04 - 8.07	QJBA DuraTorq-TDCi	4	█	Y-548J	94832	75	
Mondeo '01 2.2 TDCi		2.2	114	09.04 - 8.07	QJBB DuraTorq-TDCi	4	█	Y-548J	94832	75	
Mondeo '01 2.5 V6 24V		2.5	125	10.00 - 8.07	LCBD Duratec-VE SFI	6	1,3	PTR5D-13	6644		LPG 5
Mondeo '01 3.0 V6 24V		3.0	150	10.00 - 8.07	REBA Duratec-ST SFI	6	1,3	PTR6D-13G	6989		LPG 5
Mondeo '01 2.5 ST 220		3.0	166	10.00 - 8.07	MEBA Duratec-ST SFI	6	1,3	PTR6D-13G	6989		LPG 5

Code *l* kW

Cyl.



Stock-No.

VLINE

10-15-20-25-30-35-40-45-50-55-60-65-70-75-80-85-90-95-100-105-110-115-120-125-130-135-140-145-150-155-160-165-170-175-180-185-190-195-200-205-210-215-220-225-230-235-240-245-250-255-260-265-270-275-280-285-290-295-300-305-310-315-320-325-330-335-340-345-350-355-360-365-370-375-380-385-390-395-400-405-410-415-420-425-430-435-440-445-450-455-460-465-470-475-480-485-490-495-500-505-510-515-520-525-530-535-540-545-550-555-560-565-570-575-580-585-590-595-600-605-610-615-620-625-630-635-640-645-650-655-660-665-670-675-680-685-690-695-700-705-710-715-720-725-730-735-740-745-750-755-760-765-770-775-780-785-790-795-800-805-810-815-820-825-830-835-840-845-850-855-860-865-870-875-880-885-890-895-900-905-910-915-920-925-930-935-940-945-950-955-960-965-970-975-980-985-990-995-1000

LPG/CNG

**FORD  
MONDEO '07**

Mondeo '07 1.6 Ti		1.6	81	02.07 -	RHBA Duratec - 16V Ti-VCT	4	1,3	TR5B-13	4559		LPG 4
Mondeo '07 1.6 TDCi Norm EU V		1.6	85	11.10 -		4	█	Y8001AS	8904	58	
Mondeo '07 1.6 Ti		1.6	88	07.10 -		4	1,3	TR5B-13	4559		LPG 4
Mondeo '07 1.6 Ti		1.6	92	02.07 -	PNBA Duratec - 16V Ti-VCT	4	1,3	TR5B-13	4559		LPG 4
Mondeo '07 1.6 EcoBoost		1.6	118	02.11 -	JTBA / JTBB	4	0,8	ILZTR6A8G	94769		
Mondeo '07 1.8 TDCi		1.8	74	02.07 -	FFBA DuraTorq-TDCi	4	█	Y-524J	4520	27	
Mondeo '07 2.0 TDCi		2.0	85	02.07 -	KLBA / LPBA / TYBA	4	█	Y1005J	7957	56	
Mondeo '07 2.0 TDCi		2.0	96	02.07 -	AZBA	4	█	Y1005J	7957	56	
Mondeo '07 2.0 TDCi		2.0	100	03.07 -	AZBC	4	█	Y1005J	7957	56	
Mondeo '07 2.0 TDCi		2.0	103	02.07 -	QXBB / UFBA	4	█	Y1005J	7957	56	
Mondeo '07 2.0		2.0	107	02.07 -	AOBA / AOBC	4	1,3	TR6AP-13	5809		LPG 5
Mondeo '07 2.0 Flexifuel		2.0	107	03.07 -	TBBA / TBBB	4	1,3	TR6AP-13	5809		LPG 5
Mondeo '07 2.0 LPG		2.0	107	03.09 -	TBBA	4	1,3	TR6AP-13	5809		LPG 5
Mondeo '07 2.0 TDCi Norm EU V		2.0	120	03.10 -	TXBA	4	█	Y8001AS	8904	58	
Mondeo '07 2.2 TDCi		2.2	129	03.08 - 10.10	Q4BA	4	█	YE08	4966		
Mondeo '07 2.3		2.3	118	02.07 -	SEBA Duratec	4	1,3	ILTR5A-13G	3811		ILTR6A-13G
Mondeo '07 2.5		2.5	162	02.07 -	HUBA	5	0,8	PLFR6A	5472		LPG 7

**ORION '91**

Orion '91 1.3		1.3	44	08.90 - 07.93	J6A HCS CFI	4	1,0	PTR5D-10	3784	31	LPG 5
Orion '91 1.3		1.3	44	08.90 - 07.93	JBE HCS 2V	4	1,0	PTR5D-10	3784	31	LPG 5
Orion '91 1.3		1.3	46	08.90 - 07.93	JBD HCS 2V	4	1,0	PTR5D-10	3784	31	LPG 5
Orion '91 1.4		1.4	52	08.90 - 07.93	F6F CVH CFI	4	1,1	BCPR6ES-11	7121	11	LPG 3
Orion '91 1.4		1.4	52	08.90 - 07.93	F6G CVH CFI	4	1,1	BCPR6ES-11	7121	11	LPG 3
Orion '91 1.4		1.4	54	08.90 - 07.93	FUH CVH 2V	4	0,8	BCPR6ES	2330	12	LPG 3
Orion '91 1.6 16V		1.6	66	08.90 - 07.93	L1E ZETEC SEFI	4	1,3	PTR5A-13	2467	25	LPG 4
Orion '91 1.6 16V		1.6	66	08.90 - 07.93	LUJ CVH 2V	4	0,8	BCPR6ES	2330	12	LPG 3
Orion '91 1.6 16V		1.6	66	08.90 - 07.93	LUK CVH 2V	4	0,8	BCPR6ES	2330	12	LPG 3
Orion '91 1.6		1.6	77	08.90 - 07.93	LJF CVH EFI	4	1,1	BCPR6ES-11	7121	11	LPG 3
Orion '91 1.6		1.6	79	08.90 - 07.93	LJE CVH EFI	4	1,1	BCPR6ES-11	7121	11	LPG 3
Orion '91 1.8 D		1.8	44	08.90 - 07.93	RTE	4	█	Y-910R	4751	3	
Orion '91 1.8 D		1.8	44	08.90 - 07.93	RTF	4	█	Y-910R	4751	3	
Orion '91 1.8 D		1.8	44	08.90 - 07.93	RTH	4	█	Y-910R	4751	3	
Orion '91 1.8 TD		1.8	66	08.90 - 07.93	RFD	4	█	Y-910R	4751	3	
Orion '91 1.8 TD		1.8	66	08.90 - 07.93	RFK	4	█	Y-910R	4751	3	
Orion '91 1.8 16V		1.8	77	08.90 - 07.93	RDA ZETEC SEFI	4	1,3	PTR5A-13	2467	25	LPG 4
Orion '91 1.8 16V		1.8	96	08.90 - 07.93	RQB ZETEC SEFI	4	1,3	PTR5A-13	2467	25	LPG 4

**PROBE**

Probe 2.0		2.0	85	01.93 - 07.97	FS DOHC 16V SEFI	4	1,1	BCPR6ES-11	7121	11	LPG 3
Probe 2.2 GT		2.2	108	03.91 - 12.92	OHC EFI	4	1,1	ZFR6F-11	4291		LPG 6
Probe 2.5 V6 24V		2.5	120	01.93 - 07.97	KL V6 24V EFI	6	1,1	ZFR6F-11	4291		LPG 6

**PUMA '97**

Puma '97 1.4 16V	EC	1.4	66	06.97 - 12.01	FHD ZETEC-SE SEFI	4	1,3	PTR5A-13	2467	25	LPG 4
Puma '97 1.4 16V	EC	1.4	66	06.97 - 12.01	FHF ZETEC-SE SEFI	4	1,3	PTR5A-13	2467	25	LPG 4
Puma '97 1.6 16V	EC	1.6	76	06.97 - 12.01	L1W ZETEC-SE SFI	4	1,3	PTR5A-13	2467	25	LPG 4
Puma '97 1.7 16V	EC	1.7	92	06.97 - 12.01	MHA ZETEC-S VCT SFI	4	1,3	PTR5A-13	2467	25	LPG 4
Puma '97 1.7 16V	EC	1.7	92	06.97 - 12.01	MHB ZETEC-S VCT SFI	4	1,3	PTR5A-13	2467	25	LPG 4



Code *l* kW

Cyl.



Stock-No.

LPG/CNG

**FORD****SCORPIO '85**

Scorpio '85 1.8		1.8	66	05.85 - 10.94	REC OHC 2V	4	0,8	APR6FS	2922		
Scorpio '85 2.0		2.0	74	05.85 - 10.94	NE4 OHC 2V	4	0,8	APR6FS	2922		
Scorpio '85 2.0		2.0	74	05.85 - 10.94	NER OHC 2V	4	0,8	APR6FS	2922		
Scorpio '85 2.0 i		2.0	74	05.85 - 10.94	NRC OHC EFI	4	0,8	APR6FS	2922		
Scorpio '85 2.0		2.0	77	05.85 - 10.94	N8D DOHC 2V	4	0,8	BCPR6ES	2330	12	LPG 3
Scorpio '85 2.0		2.0	77	05.85 - 10.94	NEL OHC 2V	4	0,8	APR6FS	2922		
Scorpio '85 2.0		2.0	77	05.85 - 10.94	NEL OHC 2V Cat.	4	0,8	APR6FS	2922		
Scorpio '85 2.0		2.0	80	05.85 - 10.94	N8B DOHC 2V	4	0,8	BCPR6ES	2330	12	LPG 3
Scorpio '85 2.0 i		2.0	85	05.85 - 10.94	N9F DOHC EFI	4	0,8	BCPR6ES	2330	12	LPG 3
Scorpio '85 2.0 i		2.0	85	05.85 - 10.94	NRA OHC EFI	4	0,8	APR6FS	2922		
Scorpio '85 2.0 i		2.0	85	05.85 - 10.94	NRA OHC EFI Cat.	4	0,8	APR6FS	2922		
Scorpio '85 2.0 i		2.0	85	05.85 - 10.94	NRI OHC EFI	4	0,8	APR6FS	2922		
Scorpio '85 2.0 i		2.0	88	05.85 - 10.94	N9D DOHC EFI	4	0,8	BCPR6ES	2330	12	LPG 3
Scorpio '85 2.0 i		2.0	90	05.85 - 10.94	N9B DOHC EFI	4	0,8	BCPR6ES	2330	12	LPG 3
Scorpio '85 2.4 i		2.4	92	05.85 - 10.94	ARD V6 EFI	6	1,0	BPR6EFS	3623	7	LPG 5
Scorpio '85 2.4 i		2.4	96	05.85 - 10.94	ARC V6 EFI	6	0,8	BCPR6ES	2330	12	LPG 3
Scorpio '85 2.5 D		2.5	51	05.85 - 10.94	STR D	4	█	Y-924J	7906	1	
Scorpio '85 2.5 TD		2.5	68	05.85 - 10.94	SFA D TURBO	4	█	Y-924J	7906	1	
Scorpio '85 2.5 TD		2.5	68	05.85 - 10.94	SFB D TURBO	4	█	Y-924J	7906	1	
Scorpio '85 2.5 TD		2.5		11.94 - 07.98	SCB	4	█	Y-741U	6943	20	
Scorpio '85 2.8 i		2.8	105	05.85 - 10.94	PR4 V6 EFI	6	0,8	BPR6ES	7822	2	LPG 2
Scorpio '85 2.8 i		2.8	107	05.85 - 10.94	PR3 V6 EFI	6	0,8	BPR6ES	7822	2	LPG 2
Scorpio '85 2.8 i		2.8	110	05.85 - 10.94	PRE V6 EFI	6	0,8	BPR6ES	7822	2	LPG 2
Scorpio '85 2.9 i		2.9	107	05.85 - 10.94	BRD V6 EFI	6	1,0	BPR6EFS	3623	7	LPG 5
Scorpio '85 2.9 i		2.9	107	05.85 - 10.94	BRE V6 EFI	6	1,0	BPR6EFS	3623	7	LPG 5
Scorpio '85 2.9 i		2.9	107	05.85 - 10.94	BRF V6 EFI	6	1,0	BPR6EFS	3623	7	LPG 5
Scorpio '85 2.9 i		2.9	110	05.85 - 10.94	BRC V6 EFI	6	0,8	BCPR6ES	2330	12	LPG 3
Scorpio '85 2.9 i Cosworth		2.9	143	05.85 - 10.94	BOA V6 24V EFI	6	1,1	BKR6EVX-11	3540		LPG 1

**SCORPIO '95**

Scorpio '95 2.0 i		2.0	85	10.94 - 06.98	NSD DOHC 8V SEFI	4	1,1	PFR6B-11	4014		PFR7B
Scorpio '95 2.0 i		2.0	100	10.94 - 06.98	N3A DOHC 16V SEFI	4	1,1	PFR6B-11	4014		PFR7B
Scorpio '95 2.3		2.3	108	10.94 - 06.98	Y5A 16V SEFI	4	1,1	BKR6EVX-11	3540		LPG 1
Scorpio '95 2.5 TD		2.5	85	10.94 - 06.98	SCC TCI	4	█	Y-741U	6943	20	
Scorpio '95 2.5 TD		2.5	92	10.94 - 06.98	SCD TCI	4	█	Y-741U	6943	20	
Scorpio '95 2.9 i		2.9	110	10.94 - 06.98	BRG V6 12V SEFI	6	1,0	BPR6EFS	3623	7	LPG 5
Scorpio '95 2.9 i Cosworth		2.9	152	10.94 - 06.98	BOB V6 24V SEFI	6	1,1	PFR6B-11	4014		PFR7B

**SIERRA '87**

Sierra '87 1.6		1.6	53	01.87 - 12.92	LSF OHC 2V	4	0,8	APR6FS	2922		
Sierra '87 1.6		1.6	55	01.87 - 12.92	LSE OHC 2V	4	0,8	APR6FS	2922		
Sierra '87 1.6		1.6	55	01.87 - 12.92	LSE OHC 2V Cat.	4	0,8	APR6FS	2922		
Sierra '87 1.6		1.6	59	01.87 - 12.92	L6B CVH CFI	4	1,1	BCPR6ES-11	7121	11	LPG 3
Sierra '87 1.8 TD		1.8	55	01.87 - 12.92	RFA	4	█	Y-910R	4751	3	
Sierra '87 1.8 TD		1.8	55	01.87 - 12.92	RFB	4	█	Y-910R	4751	3	
Sierra '87 1.8 TD		1.8	55	01.87 - 12.92	RFL	4	█	Y-910R	4751	3	
Sierra '87 1.8		1.8	59	01.87 - 12.92	RED OHC 2V Cat.	4	0,8	APR6FS	2922		
Sierra '87 1.8		1.8	59	01.87 - 12.92	REF OHC 2V	4	0,8	APR6FS	2922		
Sierra '87 1.8		1.8	63	01.87 - 12.92	R6A CVH CFI	4	1,1	BCPR6ES-11	7121	11	LPG 3
Sierra '87 1.8		1.8	64	01.87 - 12.92	R2C CVH 2V	4	1,1	BCPR6ES-11	7121	11	LPG 3
Sierra '87 1.8		1.8	66	01.87 - 12.92	R2A CVH 2V	4	1,1	BCPR6ES-11	7121	11	LPG 3
Sierra '87 1.8		1.8	66	01.87 - 12.92	RED OHC 2V	4	0,8	APR6FS	2922		

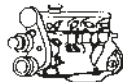
Code *l* kW

Cyl.



Stock-No.



LPG/CNG

**FORD  
SIERRA '87**

Sierra '87 2.0 i		2.0	74	01.87 - 12.92	N4B OHC EFI	4	0,8	APR6FS	2922		
Sierra '87 2.0 i		2.0	74	01.87 - 12.92	NE5 OHC 2V	4	0,8	APR6FS	2922		
Sierra '87 2.0 i		2.0	74	01.87 - 12.92	NEJ OHC 2V	4	0,8	APR6FS	2922		
Sierra '87 2.0		2.0	77	01.87 - 12.92	N8C DOHC 2V	4	0,8	BCPR6ES	2330	12	LPG 3
Sierra '87 2.0		2.0	77	01.87 - 12.92	NES OHC 2V	4	0,8	APR6FS	2922		
Sierra '87 2.0		2.0	77	01.87 - 12.92	NES OHC 2V Cat.	4	0,8	APR6FS	2922		
Sierra '87 2.0 i		2.0	80	01.87 - 12.92	N8A DOHC 2V	4	0,8	BCPR6ES	2330	12	LPG 3
Sierra '87 2.0 i		2.0	85	01.87 - 12.92	N4A OHC EFI	4	0,8	APR6FS	2922		
Sierra '87 2.0 i		2.0	85	01.87 - 12.92	N4A OHC EFI Cat.	4	0,8	APR6FS	2922		
Sierra '87 2.0 i		2.0	85	01.87 - 12.92	N4I OHC EFI	4	0,8	APR6FS	2922		
Sierra '87 2.0 i		2.0	85	01.87 - 12.92	N9E DOHC EFI	4	0,8	BCPR6ES	2330	12	LPG 3
Sierra '87 2.0 i		2.0	88	01.87 - 12.92	N9C DOHC EFI	4	0,8	BCPR6ES	2330	12	LPG 3
Sierra '87 2.0 i		2.0	90	01.87 - 12.92	N9A DOHC EFI	4	0,8	BCPR6ES	2330	12	LPG 3
Sierra '87 2.0 RS Cosworth		2.0	150	01.87 - 12.92	N5B DOHC COSWORTH	4	0,9	R7234-9	5487		
Sierra '87 2.0 16V Cosworth 4x4		2.0	162	01.87 - 12.92	N5C DOHC COSWORTH	4	1,1	PFR7B-11	5667		PFR8B
Sierra '87 2.0 16V Cosworth 4x4		2.0	162	01.87 - 12.92	N5D DOHC COSWORTH	4	1,1	PFR7B-11	5667		PFR8B
Sierra '87 2.3 D		2.3	49	01.87 - 12.92	YTR	4		Y-924J	7906	1	
Sierra '87 2.8 i		2.8	105	01.87 - 12.92	PR8 V6 EFI	6	0,8	BPR6ES	7822	2	LPG 2
Sierra '87 2.8 i		2.8	107	01.87 - 12.92	PR7 V6 EFI	6	0,8	BPR6ES	7822	2	LPG 2
Sierra '87 2.8 i		2.8	110	01.87 - 12.92	PRG V6 FI	6	0,8	BPR6ES	7822	2	LPG 2
Sierra '87 2.9 i		2.9	107	01.87 - 12.92	B4B V6 EFI	6	1,0	BPR6EFS	3623	7	LPG 5
Sierra '87 2.9 i		2.9	107	01.87 - 12.92	B4C V6 EFI	6	1,0	BPR6EFS	3623	7	LPG 5
Sierra '87 2.9 i		2.9	110	01.87 - 12.92	B4A V6 EFI	6	0,8	BCPR6ES	2330	12	LPG 3

**S-MAX**

S-MAX 1.6 TDCi Norm EU V	WS	1.6	85	02.11 -		4		Y8001AS	8904	58	
S-MAX 1.6 EcoBoost	WS	1.6	118	02.11 -	JTWA	4	0,8	ILZTR6A8G	94769		
S-MAX 1.8 TDCi	WS	1.8	74	03.06 -	FFWA	4		Y-524J	4520	27	
S-MAX 1.8 TDCi	WS	1.8	92	03.06 -	QYWA	4		Y-524J	4520	27	
S-MAX 2.0 TDCi	WS	2.0	85	11.07 -	KLWA	4		Y1005J	7957	56	
S-MAX 2.0 TDCi	WS	2.0	85	11.07 -	TYWA	4		Y8001AS	8904	58	
S-MAX 2.0 TDCi	WS	2.0	96	03.06 -	AZWA	4		Y1005J	7957	56	
S-MAX 2.0 TDCi	WS	2.0	100	05.06 -	AZWC / UKWA	4		Y1005J	7957	56	
S-MAX 2.0 TDCi	WS	2.0	103	03.06 -	QXWA Duratorq-TDCi	4		Y1005J	7957	56	
S-MAX 2.0 TDCi	WS	2.0	103	03.06 -	QXWB ohne DPF	4		Y1005J	7957	56	
S-MAX 2.0 TDCi	WS	2.0	103	03.06 -	UFWA	4		Y8001AS	8904	58	
S-MAX 2.0	WS	2.0	107	03.06 -	AOWA / AOWB	4	1,3	TR6AP-13	5809		LPG 5
S-MAX 2.0 Flexifuel	WS	2.0	107	05.06 -	TBWA / TBWB	4	1,3	TR6AP-13	5809		LPG 5
S-MAX 2.0 TDCi	WS	2.0	120	03.10 -	TXWA	4		Y1005J	7957	56	
S-MAX 2.2 TDCi	WS	2.2	129	03.08 -	Q4WA	4		YE08	4966		
S-MAX 2.2 TDCi	WS	2.2	147	07.10 -	KNWA	4		YE08	4966		
S-MAX 2.3	WS	2.3	118	08.07 -	SEWA Duratec-HE	4	1,3	ILTR5A-13G	3811		ILTR6A-13G
S-MAX 2.5 ST	WS	2.5	162	03.06 -	HUWA	5	0,8	PLFR6A	5472		LPG 7

**SPORTKA**

Sportka		1.6		05.03 -	Duratec Rocam	4	1,3	TR5B-13	4559		LPG 4
---------	--	-----	--	---------	---------------	---	-----	---------	------	--	-------

**STREETKA**

Streetka		1.6	70	01.03 - 07.05	CDRA Duratec 8V	4	1,3	TR5B-13	4559		LPG 4
Streetka		1.6	70	01.03 - 07.05	CDRB Duratec 8V	4	1,3	PTR5A-13	2467	25	LPG 4

Code *l* kW

Cyl.

Stock-No.  
**VEINE**  
BY FORD/VEINE

LPG/CNG

**FORD****TOURNEO CONNECT**

Tourneo Connect		1.8	55	06.02 -	BHPA Endura-DI	4		Y-524J	4520	27	
Tourneo Connect		1.8	66	06.02 -	HCPA Duratorq-TDCi	4		Y-524J	4520	27	
Tourneo Connect		1.8	66	06.02 -	HCPB Duratorq-TDCi	4		Y-524J	4520	27	
Tourneo Connect		1.8	81	06.02 -	RWPA Duratorq-TDCi	4		Y-524J	4520	27	
Tourneo Connect		1.8	85	06.02 -	EYPA ZETEC-E SFI	4	1,3	PTR5A-13	2467	25	LPG 4
Tourneo Connect		1.8	85	06.02 -	EYPC ZETEC-E SFI	4	1,0	TR5A-10	0005		LPG 4

**TRANSIT CONNECT**

Transit Connect		1.8	55	06.02 -	BHPA Endura-DI	4		Y-524J	4520	27	
Transit Connect		1.8	66	06.02 -	HCPA Duratorq-TDCi	4		Y-524J	4520	27	
Transit Connect		1.8	66	06.02 -	HCPB Duratorq-TDCi	4		Y-524J	4520	27	
Transit Connect		1.8	81	06.02 -	RWPA Duratorq-TDCi	4		Y-524J	4520	27	
Transit Connect		1.8	85	06.02 -	EYPA ZETEC-E SFI	4	1,3	PTR5A-13	2467	25	LPG 4
Transit Connect		1.8	85	06.02 -	EYPC ZETEC-E SFI	4	1,0	TR5A-10	0005		LPG 4
Transit '92		2.0	66	08.91 - 07.94	NBA OHC 2V	4	0,8	APR6FS	2922		
Transit '92		2.0	72	08.91 - 07.94	NCA OHC EFI	4	0,8	APR6FS	2922		
Transit '92		2.9	107	08.91 - 07.94	BRT V6 EFI	6	1,1	BCPR6ES-11	7121	11	LPG 3
Transit '95		2.0	84	08.94 - 07.00	NSF DOHC 8V SEFI	4	1,1	BKR7EVX-11	4685		BKR8EIX
Transit '95		2.0	84	08.94 - 07.00	NSG DOHC 8V SEFI	4	1,1	BKR7EVX-11	4685		BKR8EIX
Transit '95		2.0	84	08.94 - 07.00	NSH DOHC-8V SEFI	4	1,1	BKR7EVX-11	4685		BKR8EIX
Transit 2000.5 (Vorderradantrieb)		2.0	55	08.00 - 05.06	D3FA	4		Y-548J	94832	75	
Transit 2000.5 (Vorderradantrieb)		2.0	63	08.00 - 05.06	F3FA	4		Y-548J	94832	75	
Transit 2000.5 (Vorderradantrieb)		2.0	74	08.00 - 05.06	ABFA	4		Y-548J	94832	75	
Transit 2000.5 (Vorderradantrieb)		2.0	92	08.00 - 05.06	FIFA	4		Y-548J	94832	75	
Transit 2000.5 (Hinterradantrieb)		2.3	107	01.00 - 05.06	E5FA	4	1,1	PFR6B-11	4014		PFR7B
Transit 2000.5 (Hinterradantrieb)		2.3	107	01.00 - 05.06	E5FC	4	1,1	PFR6B-11	4014		PFR7B
Transit 2000.5 (Hinterradantrieb)		2.4	55	01.00 - 05.06	F4FA	4		Y-548J	94832	75	
Transit 2000.5 (Hinterradantrieb)		2.4	66	01.00 - 05.06	D2FA	4		Y-548J	94832	75	
Transit 2000.5 (Hinterradantrieb)		2.4	66	01.00 - 05.06	D2FB	4		Y-548J	94832	75	
Transit 2000.5 (Hinterradantrieb)		2.4	85	01.00 - 05.06	FXFA	4		Y-548J	94832	75	
Transit 2000.5 (Hinterradantrieb)		2.4	88	01.00 - 05.06	D4FA	4		Y-548J	94832	75	
Transit 2000.5 (Hinterradantrieb)		2.4	92	01.00 - 05.06	DOFA	4		Y-548J	94832	75	
Transit 2000.5 (Hinterradantrieb)		2.4	101	01.00 - 05.06	H9FA	4		Y-548J	94832	75	
Transit 2006.5 (Vorderradantrieb)		2.2	63	04.06 -	P8FA	4		Y-548J	94832	75	
Transit 2006.5 (Vorderradantrieb)		2.2	81	04.06 -	QVFA	4		Y-548J	94832	75	
Transit 2006.5 (Vorderradantrieb)		2.2	96	04.06 -	QWFA	4		Y-548J	94832	75	
Transit 2006.5 (Hinterradantrieb)		2.4	74	04.06 -	PHFA	4		Y-548J	94832	75	
Transit 2006.5 (Hinterradantrieb)		2.4	85	04.06 -	JXFA	4		Y-548J	94832	75	
Transit 2006.5 (Hinterradantrieb)		2.4	103	04.06 -	H9FB	4		Y-548J	94832	75	

**WINDSTAR**

Windstar		3.0	109	10.94 -	V6 SEFI	6	1,0	TR5	2238		LPG 5
----------	--	-----	-----	---------	---------	---	-----	-----	------	--	-------

**FORD (USA)****BRONCO**

Bronco		4.9		87 - 95	Y EFI	6	1,1	WR4-1	4652		
Bronco		5.0		85 - 96	N EFI	8	1,1	UR4	6630		UR5IX
Bronco		5.8		88 - 95	H EFI	8	1,3	UR5	2771		UR6IX
Bronco II		4.0		90 -	X EFI	6	1,5	TR55	3951		LPG 5

**GT**

GT		5.4	368	09.06 -		8	1,0	TR6	4177		LPG 5
----	--	-----	-----	---------	--	---	-----	-----	------	--	-------

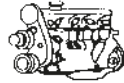
Code *ℓ* kW

Cyl.

Stock-No.  
**V-FLINE**  
10-15-20-25-30-35-40-45-50-55-60-65-70-75-80-85-90-95-100-105-110-115-120-125-130-135-140-145-150-155-160-165-170-175-180-185-190-195-200-205-210-215-220-225-230-235-240-245-250-255-260-265-270-275-280-285-290-295-300-305-310-315-320-325-330-335-340-345-350-355-360-365-370-375-380-385-390-395-400-405-410-415-420-425-430-435-440-445-450-455-460-465-470-475-480-485-490-495-500-505-510-515-520-525-530-535-540-545-550-555-560-565-570-575-580-585-590-595-600-605-610-615-620-625-630-635-640-645-650-655-660-665-670-675-680-685-690-695-700-705-710-715-720-725-730-735-740-745-750-755-760-765-770-775-780-785-790-795-800-805-810-815-820-825-830-835-840-845-850-855-860-865-870-875-880-885-890-895-900-905-910-915-920-925-930-935-940-945-950-955-960-965-970-975-980-985-990-995-1000

LPG/CNG

**FORD (USA)  
MUSTANG**

Mustang (Mexico)		3.0		06 -	V6 24V DOHC	6	1,5	TR55	3951		LPG 5
Mustang		3.8		03 -	V6	6	1,5	TR55	3951		LPG 5
Mustang		4.0		05 -	V6	6	1,1	TR5-1	7060		TR5-1IX
Mustang		4.6		03 -	V8	8	1,5	TR55	3951		LPG 5

**TAURUS**

Taurus		3.0		89 - 95	Y DOHC V6 SFI	6	1,1	PFR5G-11	2647		PFR6G-11
Taurus		3.0		92 - 99	U OHV V6 SFI	6	1,0	TR5	2238		LPG 5
Taurus		3.0		96 - 99	N SHO V8 SFI	8	1,0	TR5	2238		LPG 5
Taurus		3.0		96 - 99	S DOHC V6 SFI	6	1,5	TR55	3951		LPG 5
Taurus		3.2		93 - 95	P SHO V6 SFI	6	1,1	PFR5G-11	2647		PFR6G-11

**THUNDERBIRD**

Thunderbird		3.8		88 - 97	4 EFI V6 EFI	6	1,5	TR55-1	2683		TR55-1IX
Thunderbird		3.8		89 - 95	R EFI V6 EFI	6	1,5	TR55-1	2683		TR55-1IX
					Supercharged						
Thunderbird		3.9		- 02	A EFI V8 DOHC	8	1,1	BKR5ES-11	2382	33	LPG 1
Thunderbird		3.9		03 -	A EFI V8 DOHC	8	1,0	FR5AP-11	5463		
Thunderbird		4.6		94 - 97	W EFI V8 SOHC	8	1,5	TR55	3951		LPG 5
Thunderbird		5.0		91 - 93	T EFI V8 H O	8	1,5	UR45	6945		UR5IX

**FSO**

Polonez		1.4	75	09.93 -	16DOHC Rover	4	0,8	BKR6ES	3783	28	LPG 1
Polonez		1.5	60	07.95 -	Cat.	4		BP6ET	1263		LPG 2
Polonez		1.6	64	07.95 -	Cat.	4		BP6ET	1263		LPG 2
Polonez Caro D		1.9	51	10.92 -	XUD Kat.	4		Y-924J	7906	1	

**GAZ (VOLGA)**

Gazel		2.5	119	07 -	3M3-4052	4	0,9	BPR5ES	7422	6	LPG 2
Gazel Euro3		2.5	119	07 -	3M3-405.24	4	0,8	BKR5ES	2460	35	LPG 1
Gazel		2.7	105	07 -	3M3-409	4	0,9	BPR5ES	7422	6	LPG 2
Gazel Euro3		2.7	105	07 -	3M3-409.10	4	0,8	BKR5ES	2460	35	LPG 1
Sobol		2.5	119	07 -	3M3-4052	4	0,9	BPR5ES	7422	6	LPG 2
Sobol Euro3		2.5	119	07 -	3M3-405.24	4	0,8	BKR5ES	2460	35	LPG 1
Sobol		2.7	105	07 -	3M3-409	4	0,9	BPR5ES	7422	6	LPG 2
Sobol Euro3		2.7	105	07 -	3M3-409.10	4	0,8	BKR5ES	2460	35	LPG 1
Volga		2.7	105	07 -	3M3-409	4	0,9	BPR5ES	7422	6	LPG 2
Volga Euro3		2.7	105	07 -	3M3-409.10	4	0,8	BKR5ES	2460	35	LPG 1
Volga 31105-501		2.4	110	06 -	DCC		1,1	LZTR4A-11	5444		
Volga 3111		2.3	107	00 -	3M3-4062.10	4	0,9	BPR5ES	7422	6	LPG 2
Volga 3111		2.5	112	00 -	3M3-4052.10	4	0,9	BPR5ES	7422	6	LPG 2

**HOMMEL**

Berlinette RS 16V		2.0	123	98 -	XU10.J4RS	4		BKR6EK	2288	20	LPG 1
-------------------	--	-----	-----	------	-----------	---	--	--------	------	----	-------

**HONDA  
ACCORD**

Accord 1,8 i/iLS	CE7	1.8	85	96 - 10.98	F18A3	4	1,1	ZFR6F-11	4291		LPG 6
Accord 1,8 iS	CG8	1.8	100	99 - 02.03	F18B2	4	1,1	ZFR6F-11	4291		LPG 6
Accord 2,0	CB3	2.0	66	90 - 05.93	F20A2 Cat.	4	1,1	ZFR6F-11	4291		LPG 6

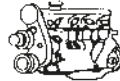

Code *l* kW

Cyl.



Stock-No.

VTEC  
iD-POWER  
LPG/CNG**HONDA****ACCORD**

Accord 2,0	CB3	2.0	66	90 - 05.93	F20A6	4	1,1	ZFR6F-11	4291		LPG 6
Accord TDi		2.0	77	05.95 - 08.99	Rover (L-Serie)	4		Y-730U	6704	17	
Accord Tdi	CF1	2.0	77	09.99 -	20TN2	4		Y-730U	6704	17	
Accord 2,0i	CC7	2.0	85	93 -	F30Z2	4	1,1	ZFR6F-11	4291		LPG 6
Accord 2,0 S,LS,ES	CC7	2.0	96	93 -	F20Z1	4	1,1	ZFR6F-11	4291		LPG 6
Accord 2,0i LS	CE8	2.0	96	95 -		4	1,1	ZFR6F-11	4291		LPG 6
Accord 2,0i LS/ES	CE8	2.0	96	96 -	F20Z1	4	1,1	ZFR6F-11	4291		LPG 6
Accord 2,0i 16V	CA5	2.0	98	88 -	B20A8 Cat.	4	1,1	BCPR6E-11	3132	11	LPG 3
Accord 2,0i	CB3	2.0	98	01.90 - 10.98	F20A4	4	1,1	ZFR6F-11	4291		LPG 6
Accord 2,0i	CB3	2.0	98	90 -	F20A8	4	1,1	ZFR6F-11	4291		LPG 6
Accord 2,0i 16V EX	CA	2.0	101	87 -	B20A2	4	1,1	BCPR6EY-N-11	6262		LPG 3
Accord 2,0iLS / iES	CG9	2.0	108	99 - 02.03	F20B6	4	1,1	ZFR6F-11	4291		LPG 6
Accord 2,0i	CL7	2.0	114	10.02 -	K20A6	4	1,1	ZFR6K-11	6711		
Accord 2.0 Sport	CL7	2.0	114	10.02 -	K20A6	4	1,1	ZFR6K-11	6711		
Accord 2.0	CU1 / CW1	2.0	115	06.08 -	R20A3	4	1,1	IZFR6K11NS	9329		
Accord 2,2i (4WS)	CB7	2.2	110	90 - 05.03	F22A3	4	1,1	ZFR6F-11	4291		LPG 6
Accord 2,2i 16V	CE9	2.2	110	95 - 10.98		4	1,1	ZFR6F-11	4291		LPG 6
Accord 2,2i VTEC	CE9	2.2	110	95 - 10.98	F22Z2	4	1,1	ZFR6F-11	4291		LPG 6
Accord 2,2iR	CH1	2.2	156	99 - 02.03	H22A7	4	1,1	PZFR6F-11	3271		LPG 6
Accord 2,3 ES	CL3	2.3	113	01 - 05.03	F23Z5	4	1,1	ZFR6F-11	4291		LPG 6
Accord 2,3 SR	CC7	2.3	116	93 - 05.03	H23A3	4	1,1	ZFR6F-11	4291		LPG 6
Accord 2,4i	CL9	2.4	140	02.03 -	K24A3	4	1,1	IZFR6K11	6994		IZFR6K11
Accord 2.4 Sport	CL9	2.4	140	02.03 -	K24A3	4	1,1	IZFR6K11	6994		IZFR6K11
Accord 2.4	CU2	2.4	148	09 -	K24Z3	4	1,1	ILZKR7B11GS	7960		ILZKR7B11GS

**ACCORD AERO**

Accord Aero 2,0 EX	CA-53700C	2.0	75	87 -	A20A1 Cat. 5MT	4	1,1	BPR6EY-11	4228	10	LPG 2
Accord Aero 2,0 EX	CA-54700C	2.0	76	87 -	A20A1 Cat. 4AT	4	1,1	BPR6EY-11	4228	10	LPG 2
Accord Aero 2,0 EX	CA-53300C	2.0	78	86 -	A20A2	4	1,1	BPR6EY-11	4228	10	LPG 2
Accord Aero 2,0 EX	CA-54300C	2.0	78	86 -	A20A2	4	1,1	BPR6EY-11	4228	10	LPG 2
Accord Aero 2,0i EX	CA-53800C	2.0	85	87 -	A20A3 Cat.	4	1,1	BPR6EY-11	4228	10	LPG 2
Accord Aero 2,0i EX	CA-54800C	2.0	85	87 -	A20A3 Cat.	4	1,1	BPR6EY-11	4228	10	LPG 2
Accord Aero 2,0 Exi	CA-53400C	2.0	90	86 -	A20A4	4	1,1	BPR6EY-11	4228	10	LPG 2
Accord Aero 2,0 Exi	CA-54400C	2.0	90	86 -	A20A4	4	1,1	BPR6EY-11	4228	10	LPG 2
Accord Aero 2,0i	CC9	2.0	98	93 -	F20Z3	4	1,1	ZFR6F-11	4291		LPG 6
Accord Aero 2,0i LS,ES	CE2	2.0	100	94 -	F20B3	4	1,1	ZFR6F-11	4291		LPG 6
Accord Aero 2,2i	CB8	2.2	110	91 - 91	F22A7-F22A8	4	1,1	ZFR6F-11	4291		LPG 6
Accord Aero 2,2i LS,ES	CE1	2.2	110	94 - 10.98	F22B5	4	1,1	ZFR6F-11	4291		LPG 6

**ACCORD COUPE**

Accord Coupe 2,0	CC1	2.0	98	92 -	F20A7	4	1,1	ZFR6F-11	4291		LPG 6
Accord Coupe 2,0i ES / iLS	CG4	2.0	108	01.98 -	F20B5	4	1,1	ZFR6F-11	4291		LPG 6
Accord Coupe 2,2i	CD7	2.2	110	94 - 10.98	F22B5	4	1,1	ZFR6F-11	4291		LPG 6
Accord Coupe 3,0i V6	CG2	3.0	147	98 -	J30A1	6	1,1	ZFR5F-11	2262		LPG 6
Accord Tourer	CM1	2.0	114	04.03 -	K20A6	4	1,1	ZFR6K-11	6711		
Accord Tourer	CM2	2.4	140	04.03 -	K24A3	4	1,1	IZFR6K11	6994		IZFR6K11
Accord Tourer 2.4	CW2	2.4	148	09 -	K24Z3	4	1,1	ILZKR7B11GS	7960		ILZKR7B11GS

**CIVIC**

Civic 1.3	EC8	1.3	55	88 - 09.91	D13B1	4	1,1	BCPR6E-11	3132	11	LPG 3
Civic 1.3	EC8	1.3	55	90 - 95	D13B2 Cat.	4	1,1	BCPR6E-11	3132	11	LPG 3
Civic 1.3	EG3	1.3	55	92 - 95	D13B2	4	1,1	BKR6E-11	2756	14	LPG 1

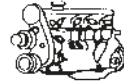
Code *l* kW

Cyl.



Stock-No.



LPG/CNG

**HONDA  
CIVIC**

Civic 1.3 IMA Hybrid	ES9	1.3	61	04 -	LDA1 Twinspark	4	1,1	IFR5G-11K	3107		IFR5G-11K
Civic 1.3i IMA Hybrid	ES9	1.3	66	03 -		4	1,1	IFR5G-11K	3107		IFR5G-11K
Civic 1.3 Hybrid	FD3	1.3	85	11.05 -	LDA	4	1,1	ILFR6J-11K	4458		ILFR6J-11K
Civic 1.4i	EJ9	1.4	55	96 - 02.01	D14A3	4	1,1	BKR6E-11	2756	14	LPG 1
Civic 1.4i	EJ9	1.4	55	99 - 02.01	D14Z1	4	1,1	ZFR5J-11	5584		LPG 6
Civic 1.4	FN / FK	1.4	61	06 -	L13A7 Twinspark	4	1,1	IFR6G-11K	1314		
Civic 1.4	EC9 / ED2	1.4	66	88 -	D14A1	4	1,1	BCPR6E-11	3132	11	LPG 3
Civic 1.4iS	EJ9	1.4	66	96 - 02.01	D14A4	4	1,1	BKR6E-11	2756	14	LPG 1
Civic 1.4iS	EJ9	1.4	66	99 - 12.05	D14Z2	4	1,1	ZFR5J-11	5584		LPG 6
Civic 1.4	EU7	1.4	66	03.01 - 09.05	D14Z6	4	1,1	ZFR5J-11	5584		LPG 6
Civic 1.4	FN4	1.4	74	09 -	L13Z1	4	1,3	IZFR6K13	6774		IZFR6K11
Civic 1.4		1.4		01.97 -	PIJ (SOHC)	4	1,1	ZFR5F-11	2262		LPG 6
Civic 1.4 i-VTEC	FB	1.4	73	02.12 -	L13Z4	4	1,3	IZFR6K13	6774		IZFR6K11
Civic 1.5i	ED6 / ED3	1.5	66	89 - 09.91	D15B2 Cat.	4	1,1	BCPR6E-11	3132	11	LPG 3
Civic 1.5 DXI/Lsi	EG4 / EG8	1.5	66	92 -	D15B2	4	1,1	BKR6E-11	2756	14	LPG 1
Civic 1.5 VEI	EG4	1.5	66	92 -	D15Z1	4	1,1	ZFR6F-11	4291		LPG 6
Civic 1.5i GT	AH-5330S	1.5	74	85 -	EW3	4	1,1	BPR6EY-11	4228	10	LPG 2
Civic 1.5i LS	EK3	1.5	84	96 -	D15Z6	4	1,1	ZFR6J-11	5585		LPG 6
Civic 1.5		1.5		97 -	VTi	4	1,1	BKR6EN-11	5724		
Civic 1.5 VTEC	P9L	1.5		01.97 - 02.01	D15Z8	4	1,1	ZFR5F-11	2262		LPG 6
Civic 1.6	ED4 / ED7	1.6	80	88 -	D16A6 Cat.	4	1,1	BCPR6E-11	3132	11	LPG 3
Civic 1.6	ED4 / ED7	1.6	81	90 - 01	D16Z2 Cat.	4	1,1	BCPR6E-11	3132	11	LPG 3
Civic 1.6	EU8	1.6	81	03.01 -	D16V1	4	1,1	ZFR6J-11	5585		LPG 6
Civic 1.6i ES	EK1	1.6	84	96 -	D16Y5	4	1,1	ZFR6J-11	5585		LPG 6
Civic 1.6 ESI	EG5 / EG9	1.6	92	92 -	D16Z6	4	1,1	BKR6E-11	2756	14	LPG 1
Civic 1.6 VTEC	EE9	1.6	110	90 -	B16A1	4	1,1	BKR6EN-11	5724		
Civic 1.6 VTI	EG6 / EG9	1.6	118	92 - 95	B16A2	4	1,1	BKR6E-11	2756	14	LPG 1
Civic 1.6 VTI	EK4	1.6	118	96 -	B16A2	4	1,1	BKR7EN-11	6256		
Civic Type R	EK9	1.6	148	- 12.01	B16B	4	1,1	PFR7G-11S	7772		
Civic 1.6		1.6		01.97 -	PIK(SOHC)	4	1,1	ZFR5F-11	2262		LPG 6
Civic 1.7 CTDi	EP4	1.7	74	02 -	4EE2	4		Y-541J	1983	42	
Civic 1.8 i-VTEC	FD1	1.8	103	09.05 -	R18A	4	1,1	IZFR6K-11S	5266		
Civic 1.8	FK2	1.8	103	06 -	R18A2	4	1,1	IZFR6K-11S	5266		
Civic Type-R	EP3	2.0	147	08.01 - 06	K20A2	4	1,1	IFR7G-11KS	7746		IFR7G-11KS
Civic Type R	FN2	2.0	148	07 -	K20ZA	4	1,1	IFR7G-11KS	7746		IFR7G-11KS
Civic 1.4i 5Door	MA8	1.4	55	96 -	D14A5	4	1,1	BKR6E-11	2756	14	LPG 1
Civic 1.4i 5Door	MB2	1.4	55	97 -	D14A7	4	1,1	ZFR5F-11	2262		LPG 6
Civic 1.4i 5Door	MB2	1.4	55	99 -	D14Z3	4	1,1	ZFR5F-11	2262		LPG 6
Civic 1.4i 5Door	MA8	1.4	66	95 -	D14A2	4	1,1	BKR6E-11	2756	14	LPG 1
Civic 1.4 iS 5Door	MB2	1.4	66	97 -	D14A8	4	1,1	ZFR5F-11	2262		LPG 6
Civic 1.4iS 5Door	MB2	1.4	66	99 -	D14Z4	4	1,1	ZFR5F-11	2262		LPG 6
Civic 1.4 5Door	EU7	1.4	66	01 - 09.05	D14Z6 SOHC	4	1,1	ZFR5J-11	5584		LPG 6
Civic 1.4 5 Door	FK1	1.4	74	09 -	L13Z1	4	1,3	IZFR6K13	6774		IZFR6K11
Civic 1.4 5 Door		1.4			PIH	4	1,1	BKR6E-11	2756	14	LPG 1
Civic 1.5 VTEC-E 5Door	MA9	1.5	66	95 -	D15Z3	4	1,1	ZFR6F-11	4291		LPG 6
Civic 1.5 Vtec 5Door	MB3	1.5	85	97 -	D15Z8	4	1,1	ZFR5F-11	2262		LPG 6
Civic 1.6 Vtec 5Door	EU8	1.6	81	01 -	D16V1 SOHC	4	1,1	ZFR6J-11	5585		LPG 6
Civic 1.6LS 5Door	MB1	1.6	83	95 -	D16Y3	4	1,1	BKR6E-11	2756	14	LPG 1
Civic 1.6 LS 5Door	MB4	1.6	85	97 -	D16B2	4	1,1	ZFR5F-11	2262		LPG 6
Civic 1.6i/LS 5Door	MB4	1.6	85	99 -	D16W3	4	1,1	ZFR5F-11	2262		LPG 6
Civic 1.6SR VTEC 5Door	MB1	1.6	93	95 -	D16Y2	4	1,1	BKR6E-11	2756	14	LPG 1

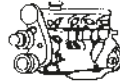
Code *l* kW

Cyl.



Stock-No.

VTEC  
iD-Power  
LPG/CNG**HONDA****CIVIC**

Civic 1.6 5 Door		1.6			PIJ DOHC	4	1,1	BKR6E-11	2756	14	LPG 1
Civic 1.6 5 Door		1.6			PIK DOHC	4	1,1	BKR6E-11	2756	14	LPG 1
Civic 1.8 VTI 5Door	MB6	1.8	124	97 -	B18C4	4	1,1	BKR6EN-11	5724		
Civic 2.0i Sport	EV1	2.0	118	04 -	K20A3	4	1,1	ZFR6K-11	6711		
Civic 1.4i Aerodeck	MB8	1.4	55	98 -	D14A7	4	1,1	ZFR6F-11	4291		LPG 6
Civic 1.4iS Aerodeck	MB8	1.4	66	98 -	D14A8	4	1,1	ZFR6F-11	4291		LPG 6
Civic 1.5i VTEC Aerodeck	MB9	1.5	85	98 -	D15Z8	4	1,1	ZFR6F-11	4291		LPG 6
Civic 1.6i SR Aerodeck	MC1	1.6	85	98 -	D16B2	4	1,1	ZFR6F-11	4291		LPG 6
Civic 1.8i VTI Aerodeck	M18C4	1.8	124	98 -	B18C4	4	1,1	BKR7EN-11	6256		

**CIVIC COUPÉ**

Civic Coupé 1,5i/Lsi	EJ2	1.5	74	94 -	D15B7	4	1,1	ZFR6F-11	4291		LPG 6
Civic Coupé 1,6 LS	EJ6	1.6	77	96 - 98	D16Y7	4	1,1	BKR6E-11	2756	14	LPG 1
Civic Coupé 1,6 LS	EJ6	1.6	77	96 - 98	D16Y7	4	1,1	BKR6E-11	2756	14	LPG 1
Civic Coupé 1,6iLS	EJ6	1.6	77	99 -	D16Y7	4	1,1	ZFR5F-11	2262		LPG 6
Civic Coupé 1,6 Esi	EJ1	1.6	92	94 -	D16Z9	4	1,1	BKR6E-11	2756	14	LPG 1
Civic Coupé 1,6i SR	EJ8	1.6	92	96 - 98	D16Y8	4	1,1	BKR6E-11	2756	14	LPG 1
Civic Coupé 1,6i SR	EJ8	1.6	92	96 -	D16Y8	4	1,1	BKR6E-11	2756	14	LPG 1
Civic Coupé 1,6 SR	EJ8	1.6	92	99 -	D16Y8	4	1,1	ZFR5F-11	2262		LPG 6
Civic Coupé 1,7 LS	EM2	1.7	88	01 -	D17A8	4	1,1	ZFR6J-11	5585		LPG 6
Civic Coupé 1,7 ES	EM2	1.7	92	01 -	D17A9	4	1,1	ZFR6J-11	5585		LPG 6

**CIVIC SHUTTLE**

Civic Shuttle 1,6i	EE	1.6	80	88 -	D16A6 Cat.	4	1,1	BCPR6E-11	3132	11	LPG 3
Civic Shuttle 1,6i	EE	1.6	81	88 -	D16Z2 Cat.	4	1,1	BCPR6E-11	3132	11	LPG 3

**CONCERTO**

Concerto 1,5i	HW	1.5	66	90 - 95	D15B2 Cat.	4	1,1	BCPR6E-11	3132	11	LPG 3
Concerto 1,6i	HW	1.6	82	90 - 95	D16Z2 SOHC Cat.	4	1,1	BCPR6E-11	3132	11	LPG 3
Concerto 1,6-16V	HW	1.6	90	90 - 95	D16A8 DOHC	4	1,1	BCPR6E-11	3132	11	LPG 3
Concerto TD	HW	1.8	64	10.94 - 12.95	XUD 7 TE	4		Y-924J	7906	1	

**CR-V**

CR-V 2.0	RD1	2.0	94	05.97 -	B20B3	4	1,1	ZFR5F-11	2262		LPG 6
CR-V 2.0	RD1	2.0	108	03.99 -	B20Z1	4	1,1	ZFR6F-11	4291		LPG 6
CR-V 2.0	RD8	2.0	110	02 -	K20A4	4	1,1	ZFR6K-11	6711		
CR-V 2.0	RE5	2.0	110	07 -	R20A2	4	1,1	IZFR6K-11S	5266		

**CRX**

CRX 1.6i-16	ED9	1.6	91	89 -	D16Z5 Cat.	4	1,1	BCPR6E-11	3132	11	LPG 3
CRX 1.6	EH6	1.6	92	92 -	D16Z6	4	1,1	BKR6E-11	2756	14	LPG 1
CRX 1.6i-16	ED9	1.6	96	88 -	D16A9	4	1,1	BCPR6E-11	3132	11	LPG 3
CRX 1.6 VTEC	EE8	1.6	110	90 -	B16A1	4	1,1	BKR6EN-11	5724		
CRX 1.6	EG2	1.6	118	92 -	B16A2	4	1,1	BKR6EN-11	5724		

**CR-Z**

CR-Z 1.5 Hybrid		1.5	84	02.10 -	LEA1	4	1,3	DIFR6D13	94167		
-----------------	--	-----	----	---------	------	---	-----	----------	-------	--	--

**FR-V**

FR-V 1.7	BE1	1.7	92	01.05 -	D17A2 SOHC VTEC	4	1,1	ZFR6J-11	5585		LPG 6
FR-V 1.8	BE1	1.8	103	01.07 -	R18A1	4	1,1	IZFR6K-11S	5266		
FR-V 2.0	BE3	2.0	110	01.05 -	K20A9 DOHC i-VTEC	4	1,1	ZFR6K-11	6711		

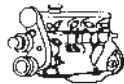
Code *ℓ* kW

Cyl.



Stock-No.

LPG/CNG

LPG/CNG

## HONDA HR-V

HR-V 1.6	GH2	1.6	77	02.99 -	D16W1	4	1,1	ZFR5J-11	5584		LPG 6
HR-V 1.6 VTEC	GH2	1.6	91	10.99 -	VTEC	4	1,1	ZFR5J-11	5584		LPG 6

## INSIGHT

Insight	ZE2	1.3	65	04.09 -	LDA3 L4	4	1,1	DILFR6J11	92491		DILFR6J11
---------	-----	-----	----	---------	---------	---	-----	-----------	-------	--	-----------

## INTEGRA

Integra Type-R 16V		2.0	162	02.02 -	K20A	4	1,1	IFR7G-11KS	7746		IFR7G-11KS
Integra R	DC2	1.8	140	10.97 - 99	B18C6	4	1,1	PFR7G-11	2380		PFR7G
Integra R	DC2	1.8	140	99 - 01	B18C6	4	1,1	PFR7G-11	2380		PFR7G

## JAZZ

Jazz 1,2 i-DSI		1.2	57	02 -	TwinSpark	4	1,1	BKR6E-11	2756	14	LPG 1
Jazz 1,2	GD5	1.2	57	03 -	L12A1 TwinSpark	4	1,1	BKR6E-11	2756	14	LPG 1
Jazz 1,2 CHAC	GE2	1.2	57	06 -	L12A4	4	1,1	BKR6E-11	2756	14	LPG 1
Jazz 1,2	GG1	1.2	66	07.08 -	L12B1	4	1,3	DIFR6D13	94167		
Jazz 1,3 CHAC	GE3	1.3	61	06 -	L13A6	4	1,1	BKR6E-11	2756	14	LPG 1
Jazz 1,4	GD1	1.4	61	02 -	L13A1 TwinSpark	4	1,1	BKR6E-11	2756	14	LPG 1
Jazz 1,4 CHAC	GE3	1.4	61	06 -	L13A6	4	1,1	BKR6E-11	2756	14	LPG 1
Jazz 1,4 Hybrid	GP1	1.4	65	04.11 -	LDA3	4	1,1	DILFR6J11	92491		DILFR6J11
Jazz 1,4	GE6	1.4	74	09 -	L13Z1	4	1,3	IZFR6K13	6774		IZFR6K11

## LEGEND

Legend V6 2,5i	HS..N	2.5	110	87 -	C25A1 Cat.	6	1,1	BCPR6E-11	3132	11	LPG 3
Legend V6 2,5i	HS..Y	2.5	110	87 -	C25A1 Cat.	6	1,1	BCPR6E-11	3132	11	LPG 3
Legend V6 2,5i	HS..N	2.5	127	87 -	C25A1	6	1,1	BCPR6E-11	3132	11	LPG 3
Legend V6 2,5i	HS..Y	2.5	127	87 -	C25A1	6	1,1	BCPR6E-11	3132	11	LPG 3
Legend 2,7i	HS / KA4	2.7	124	88 - 02.91	C27A1 Cat.	6	1,1	BCPR6E-11	3132	11	LPG 3
Legend 3,2	KA7 / KA8	3.2	151	91 - 96	C32A2	6	1,1	PFR6G-11	5555		PFR7G
Legend 3,2	KA7 / KA8	3.2	151	93 - 96	C32A2	6	1,1	PFR6G-11	5555		PFR7G
Legend 3,5 V6		3.5	151	95 - 04	C35A2	6	1,1	PFR6G-11	5555		PFR7G
Legend 3,5 V6	KA9	3.5	151	96 - 04	C35A5	6	1,1	PFR6G-11	5555		PFR7G
Legend 3.5 SH-AWD	KB1	3.5	217	06 -	J35A8	6	1,1	IZFR6K11	6994		IZFR6K11
Legend 3,5 V6	KB1	3.5	217	07 -	J35A8	6	1,1	IZFR6K11	6994		IZFR6K11
Legend Coupe 2,7i	KA3	2.7	124	88 -	C27A1 Cat.	6	1,1	BCPR6EY-N-11	6262		LPG 3

## LOGO

Logo 1,3 i		1.3	48	99 - 01	D13B7	4	1,1	ZFR5J-11	5584		LPG 6
------------	--	-----	----	---------	-------	---	-----	----------	------	--	-------

## NSX

NSX	NA1	3.0	188	91 - 01.05	C30A3/C30A4	6	1,1	PFR6G-11	5555		PFR7G
NSX	NA2	3.2	206	01.97 - 09.05	C32B2	6	1,1	PFR6G-11	5555		PFR7G

## PRELUDE

Prelude 1,8	AB-7230C	1.8	74	83 - 92	ET	4	0,8	BPR6EY	6427		LPG 2
Prelude 1,8	AB-5240C	1.8	74	85 - 92	ET2	4	1,1	BPR6EY-11	4228	10	LPG 2
Prelude 1,8	AB-5220C	1.8	77	83 - 92	ET	4	0,8	BPR6EY	6427		LPG 2
Prelude 1,8	AB-5230C	1.8	77	83 - 92	ET	4	0,8	BPR6EY	6427		LPG 2
Prelude 2,0	BA4	2.0	80	88 - 01.92	B20A3 Cat.	4	1,1	BCPR6EY-N-11	6262		LPG 3
Prelude 2,0	BA4	2.0	80	90 - 01.92	B20A3 Cat.	4	1,1	BCPR6EY-N-11	6262		LPG 3
Prelude 2,0	BA4	2.0	84	88 - 01.92	B20A4	4	1,1	BCPR6EY-N-11	6262		LPG 3
Prelude 2,0	BB3	2.0	98	92 - 12.99	F20A4	4	1,1	ZFR6F-11	4291		LPG 6
Prelude 2,0		2.0	98	97 - 12.99		4	1,1	ZFR6F-11	4291		LPG 6
Prelude 2,0 i	BB9	2.0	98	99 - 12.99	F20A4	4	1,1	ZFR6F-11	4291		LPG 6
Prelude 2,0i 16V	BA2-1300C	2.0	101	86 - 92	BA20A1 DOHC	4	1,1	BCPR6E-11	3132	11	LPG 3

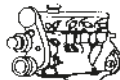

Code *l* kW

Cyl.



Stock-No.

**HONDA****PRELUDE**

Prelude 2,0 16V 4WS	BA4	2.0	101	88 - 01.92	B20A5 Cat.	4	1,1	BCPR6EY-N-11	6262		LPG 3
Prelude 2,0 16V 4WS	BA4	2.0	103	90 - 01.92	B20A9 Cat.	4	1,1	BCPR6EY-N-11	6262		LPG 3
Prelude 2,2 VTEC	BB1	2.2	136	93 - 09.96	H22A2	4	1,1	PZFR6F-11	3271		LPG 6
Prelude 2,2i		2.2	136	97 - 12.01	H22A5	4	1,1	PZFR6F-11	3271		LPG 6
Prelude 2,2 Vti	BB6 / BB8	2.2	136	99 - 12.01	H22A5	4	1,1	PZFR6F-11	3271		LPG 6
Prelude 2,3	BB2	2.3	118	92 - 09.96	H23A2	4	1,1	ZFR6F-11	4291		LPG 6

**S 2000**

S 2000	AP1	2.0	177	06.00 -	F20C2	4	1,1	PFR7G-11S	7772		
--------	-----	-----	-----	---------	-------	---	-----	-----------	------	--	--

**SHUTTLE**

Shuttle	AN-3520S	1.5	63	84 -	EW2	4	1,1	BPR6EY-11	4228	10	LPG 2
Shuttle	AN-5520S	1.5	63	84 -	EW2	4	1,1	BPR6EY-11	4228	10	LPG 2
Shuttle 4WD	AR-6520C	1.5	63	85 -	EW2	4	1,1	BPR6EY-11	4228	10	LPG 2
Shuttle 2,2i ES		2.2	110	95 - 12.97	F22 RA1 (AT)	4	1,1	ZFR6F-11	4291		LPG 6
Shuttle 2,3	RA3	2.3	110	98 - 05.01	F23A7	4	1,1	ZFR6F-11	4291		LPG 6

**STREAM**

Stream	RN1	1.7	92	04.01 -	D17A2	4	1,1	ZFR6J-11	5585		LPG 6
Stream	RN3	2.0	115	04.01 -	K20A1	4	1,1	ZFR6K-11	6711		

**HUMMER-AM GENERAL**

Hummer H 3		3.4	162	05 -		5	1,3	PTR5A-13	2467	25	LPG 4
Hummer		5.7		94 - 96	D EFI V8	8	1,3	UR5	2771		UR6IX
Hummer H 2		6.0		03 - 06	N EFI V8	8	1,0	TR5	2238		
Hummer		8.1		03 -	G EFI V8	8	1,5	PZTR5A-15	7862		PZTR5A-15

**HYUNDAI****ACCENT**

Accent		1.3	44	10.94 - 99	G4EH	4	1,1	BKR5ES-11	2382	33	LPG 1
Accent		1.3	55	10.94 - 99	G4EH	4	1,1	BKR5ES-11	2382	33	LPG 1
Accent	LC	1.3	55	99 - 03.06	G4EA	4	1,1	BKR5ES-11	2382	33	LPG 1
Accent	LC	1.3	64	99 - 03.06	G4EA	4	1,1	BKR5ES-11	2382	33	LPG 1
Accent 1.4		1.4	71	06.06 -	G4EE	4	1,1	BKR5ES-11	2382	33	LPG 1
Accent TDI		1.5	55	04.02 -		3	█	Y-749J	5013		
Accent 12V CRDi		1.5	60	04.02 -	D3EA	3	█	Y-749J	5013		
Accent		1.5	65	10.94 - 07.99	G4EK	4	1,1	BKR5ES-11	2382	33	LPG 1
Accent	LC	1.5	66	01.00 - 06	G4EB	4	1,1	BKR5ES-11	2382	33	LPG 1
Accent 16V	LC	1.5	75	99 - 06	G4EA	4	1,1	BKR5ES-11	2382	33	LPG 1
Accent III 1.5 CRDi	MC	1.5	81	11.05 -	D4FA	4	█	Y-527J	96187	67	
Accent GT 16V		1.5		95 - 07.99	G4EK	4	1,1	BKR5ES-11	2382	33	LPG 1
Accent 1.6	MC	1.6	82	06.06 -	G4ED	4	1,1	BKR5ES-11	2382	33	LPG 1

**ATOS**

Atos	MX	0.8		- 02	LPG	4	0,8	BKR6ES	3783	28	LPG 1
Atos	MX	1.0	40	99 - 02	G4HC	4	1,1	BKR5ES-11	2382	33	LPG 1
Atos Prime	MX	1.0	40	99 - 02	G4HC	4	1,1	BKR5ES-11	2382	33	LPG 1
Atos	MX	1.1	46	03.04 -		4	1,1	BKR5ES-11	2382	33	LPG 1

**COUPÉ**

Coupé	RD	1.6	84	12.96 - 04.02	4G61	4	1,1	BKR5ES-11	2382	33	LPG 1
Coupé 2.0	RD	2.0	99	01 -	G4GF-EG	4	1,1	BKR5ES-11	2382	33	LPG 1
Coupé	RD	2.0	102	03.96 - 09.01	G4GF DOHC	4	1,1	BKR5ES-11	2382	33	LPG 1

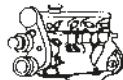
Code *l* kW

Cyl.



Stock-No.



LPG/CNG

## HYUNDAI COUPÉ

Coupé 2.0	RD	2.0	102	99 -	G4GC	4	1,1	BPR5ES-11	4424		LPG 2
Coupé	GK	2.0	105	03.02 -	G4GC-G	4	1,1	BKR5ES-11	2382	33	LPG 1
Coupé	GK	2.7	121	03.02 -	G6BA-G V6	6	1,1	PFR5J-11	4642		PFR5J-11

## ELANTRA

Elantra	XD	1.5		- 02.95	DOHC	4	1,1	BPR6ES-11	4824	13	LPG 2
Elantra	XD	1.5		03.95 - 06.05		4	1,1	BKR5E-11	6953	33	LPG 1
Elantra	XD	1.6	79	00 -	G4ED-G DOHC	4	1,1	BKR5ES-11	2382	33	LPG 1
Elantra 1.6 CRDi	XD	1.6	85	02.06 -	D4FB	4	█	Y-527J	96187	67	
Elantra	XD	1.6		- 99	DOHC	4	1,1	BPR6ES-11	4824	13	LPG 2
Elantra	XD	1.8			DOHC	4	1,1	BPR6ES-11	4824	13	LPG 2
Elantra CRDI	XD	2.0	83	01 -	D4EA	4	█	Y-749J	5013		
Elantra	XD	2.0	102	00 -	G4GC-G DOHC	4	1,1	BKR5ES-11	2382	33	LPG 1
Elantra	XD	2.0	105	03 -		4	1,1	BKR5E-11	6953	33	LPG 1

## GALLOPER

Galopper		2.5	57	- 01.94	4D55	4	█	Y-115T1	2189		
Galopper TC,TCI		2.5	65	11.95 -	4D56	4	█	CY57	4994	21	
Galopper TD 3/5p GLS, Inovation		2.5	74	01.99 -		4	█	CY57*	4994	21	
Galopper		3.0	104	08.98 - 08.01	G6AT Unleaded	6	1,1	BPR5ES-11	4424		LPG 2
Galopper		3.0	104	08.98 -	Leaded+LPG	6	0,9	BPR5ES	7422	6	LPG 2
Galopper		3.0		98 - 08.01	G6AT SOHC V6	6	1,1	BKR5ES-11	2382	33	LPG 1

## GETZ

Getz	TB	1.1	46	09.02 - 08	G4HD	4	1,1	BKR5ES-11	2382	33	LPG 1
Getz	TB	1.3	60	09.02 - 08	G4EA	4	1,1	BKR5ES-11	2382	33	LPG 1
Getz	TB	1.4	71	05 - 08	G4EE	4	1,1	BKR5ES-11	2382	33	LPG 1
Getz 1.5 CRDi	TB	1.5	60	02.03 - 07.05	D3EA	3	█	Y-749J	5013		
Getz 1.5 CRDi	TB	1.5	60	08.05 - 10.06	D3EA	3	█	Y-527J	96187	67	
Getz 1.5 CRDi	TB	1.5	65	11.06 -	D4FA	4	█	Y-527J	96187	67	
Getz 1.5 CRDi	TB	1.5	81	11.06 -	D4FA	4	█	Y-527J	96187	67	
Getz	TB	1.6	78	09.02 -	G4ED	4	1,1	BKR5ES-11	2382	33	LPG 1

## GRANDEUR

Grandeur 3.3 V6	TG	3.3	173	08.05 -	G6DB	6	1,1	IFR5G11	7854		
-----------------	----	-----	-----	---------	------	---	-----	---------	------	--	--

## H 1

H 1		2.4	85	09.97 -	H100	4	1,1	BPR6ES-11	4824	13	LPG 2
H 1 Starex TD		2.5	59	10.97 -	D4BF	4	█	Y-722JS	9974		
H 1 TD		2.5	59	03.00 - 09.00	D4BF	4	█	Y-722JS	9974		
H 1 TD		2.5	73	03.00 -	D4BH	4	█	Y-722JS	9974		
H 1 Starex		2.4	82	98 -	G4CS	4	1,1	BPR6ES-11	4824	13	LPG 2

## H 100

H 100 D		2.5	57	- 96	4D56	4	█	CY57*	4994	21	
H 100 D		2.5	57	- 96	D4BA 4D55	4	█	Y-115T1	2189		
H 100 D intercooler		2.5	63	07.93 - 03.00	D4BF	4	█	Y-722JS	9974		
H 100 i		2.4	84	01.97 -		4	1,1	BP6EY-11	4128		LPG 2

## I10

i10 1.1	PA	1.1	49	01.08 -	G4HG	4	1,1	BKR5ES-11	2382	33	LPG 1
i10 1.1	PA	1.1	51	04.11 -	G4HG	4	1,1	BKR5ES-11	2382	33	LPG 1
i10 1.1 CRDi	PA	1.1	55	03.08 -	D3FA	3	█	Y-527J	96187	67	
i10 1.2	PA	1.2	57	11.08 -	G4LA	4	0,8	PLKR7A	4288		PLKR7A
i10 1.2	PA	1.2	63	04.11 -	G4LA	4	0,8	PLKR7A	4288		PLKR7A

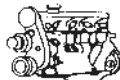
Code *l* kW

Cyl.



Stock-No.

V-TUNE

E-Power

LPG/CNG

**HYUNDAI****I20**

i20 1.2	PB	1.2	57	09.08 -	G4LA	4	0,8	PLKR7A	4288		PLKR7A
i20 1.4 CRDi	PB	1.4	55	12.08 -	D4FC	4		Y-527J	96187	67	
i20 1.4 CRDi	PB	1.4	66	05.09 -	D4FC	4		Y-527J	96187	67	
i20 1.4 (PB)	PB	1.4	74	09.08 - 01.09	G4FA	4	1,1	ZFR5F-11	2262		LPG 6
i20 1.4 (PB)	PB	1.4	74	02.09 -	G4FA	4	1,0	LZKR6B-10E	1578		
i20 1.6 CRDi	PB	1.6	85	12.08 -	D4FB	4		Y-527J	96187	67	
i20 1.6	PB	1.6	93	09.08 -	G4FC	4	1,1	ZFR5F-11	2262		LPG 6

**I30 1**

i30 1 1.4	FD	1.4	77	10.07 - 01.09	G4FA	4	1,1	ZFR5F-11	2262		LPG 6
i30 1 1.4	FD	1.4	77	02.09 -	G4FA	4	1,0	LZKR6B-10E	1578		
i30 1 1.4	FD	1.4	80	06.07 - 01.09	G4FA	4	1,1	ZFR5F-11	2262		LPG 6
i30 1 1.4	FD	1.4	80	02.09 -	G4FA	4	1,0	LZKR6B-10E	1578		
i30 1 1.6 CRDi	FD	1.6	66	10.07 -	D4FB	4		Y-527J	96187	67	
i30 1 1.6	FD	1.6	85	10.07 - 01.09	G4FC	4	1,1	ZFR5F-11	2262		LPG 6
i30 1 1.6 CRDi	FD	1.6	85	10.07 -	D4FB	4		Y-527J	96187	67	
i30 1 1.6	FD	1.6	85	02.09 -	G4FC	4	1,0	LZKR6B-10E	1578		
i30 1 1.6	FD	1.6	90	06.07 - 01.09	G4FC	4	1,1	ZFR5F-11	2262		LPG 6
i30 1 1.6	FD	1.6	90	02.09 -	G4FC	4	1,0	LZKR6B-10E	1578		
i30 1 1.6	FD	1.6	93	02.08 - 01.09	G4FC	4	1,1	ZFR5F-11	2262		LPG 6
i30 1 1.6	FD	1.6	93	02.09 -	G4FC	4	1,0	LZKR6B-10E	1578		
i30 1 1.6 CRDi	FD	1.6	94	02.08 -	D4FB	4		Y-527J	96187	67	
i30 1 2.0 CRDi	FD	2.0	103	07.07 -	D4EA	4		Y-749J	5013		
i30 1 2.0	FD	2.0	105	07.07 -	G4GC	4	1,1	BKR5ES-11	2382	33	LPG 1

**I30 2**

i30 2 1.4	GD	1.4	73	11.11 -	G4FA	4	1,0	LZKR6B-10E	1578		
i30 2 1.4 CRDi	GD	1.4	66	11.11 -	D4FC	4		Y-527J	96187	67	
i30 2 1.6 CRDi	GD	1.6	94	11.11 -	D4FB	4		Y-527J	96187	67	

**I30 CW 1**

i30 CW 1 1.4		1.4	80	06.09 -	G4FA	4	1,0	LZKR6B-10E	1578		
i30 CW 1 1.6		1.6	85	02.08 - 01.09	G4FC	4	1,1	ZFR5F-11	2262		LPG 6
i30 CW 1 1.6		1.6	85	02.09 -	G4FC	4	1,0	LZKR6B-10E	1578		
i30 CW 1 1.6		1.6	90	02.08 - 01.09	G4FC	4	1,1	ZFR5F-11	2262		LPG 6
i30 CW 1 1.6		1.6	90	02.09 -	G4FC	4	1,0	LZKR6B-10E	1578		
i30 CW 1 1.6		1.6	93	02.08 - 01.09	G4FC	4	1,1	ZFR5F-11	2262		LPG 6
i30 CW 1 1.6		1.6	93	02.09 -	G4FC	4	1,0	LZKR6B-10E	1578		
i30 CW 1 1.6 CRDi		1.6	94	02.08 -	D4FB	4		Y-527J	96187	67	
i30 CW 1 2.0		2.0	105	02.08 -	G4GC	4	1,1	BKR5ES-11	2382	33	LPG 1

**I40**

i40 CW 1.7 CRDi		1.7	85	06.11 -	D4FD	4		CZ203	95232	68	
i40 CW 1.7 CRDi		1.7	100	06.11 -	D4FD	4		CZ203	95232	68	

**IX20**

ix20 1.4 CRDi	JC	1.4	57	11.10 -	D4FC	4		Y-527J	96187	67	
ix20 1.4	JC	1.4	66	11.10 -	G4FA	4	1,0	LZKR6B-10E	1578		
ix20 1.4 CRDi	JC	1.4	66	11.10 -	D4FC	4		Y-527J	96187	67	
ix20 1.6 CRDi	JC	1.6	85	11.10 -	D4FB	4		Y-527J	96187	67	
ix20 1.6	JC	1.6	92	11.10 -	G4FC	4	1,0	LZKR6B-10E	1578		

**IX35 (LM)**

ix35 1.7 CRDi	LM	1.7	85	09.10 -	D4FD	4		CZ203	95232	68	
ix35 2.0	LM	2.0	120	08.09 -	G4KD	4	1,1	LFR5A-11	6376		LPG 7
ix35 2.0 CRDi Euro III / Euro IV	LM	2.0	100	08.09 -	D4HA	4		Y1003AS	92283		

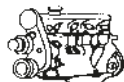
Code *l* kW

Cyl.



Stock-No.



LPG/CNG

**HYUNDAI  
IX35 (LM)**

ix35 2.0 CRDi Euro V	LM	2.0	100	08.09 -	D4HA	4		CZ105	90007		
ix35 2.0 CRDi Euro III / Euro IV	LM	2.0	135	08.09 -	D4HA	4		Y1003AS	92283		
ix35 2.0 CRDi Euro V	LM	2.0	135	08.09 -	D4HA	4		CZ105	90007		

**LANTRA**

Lantra 1	J-1	1.5	63	92 - 04.95	G4DJ	4	1,1	BPR6ES-11	4824	13	LPG 2
Lantra 2	J-2	1.6	66	09.95 - 09.00	G4GR	4	1,1	BKR5ES-11	2382	33	LPG 1
Lantra 1	J-1	1.6	78	92 - 04.95	G4CR	4	1,1	BPR6ES-11	4824	13	LPG 2
Lantra 3		1.6	79	09.00 -	G4ED-G DOHC	4	1,1	BKR5ES-11	2382	33	LPG 1
Lantra 2	J-2	1.6	84	09.95 - 09.00	G4GR	4	1,1	BKR5ES-11	2382	33	LPG 1
Lantra 1	J-1	1.8	93	92 - 04.95	G4CN	4	1,1	BPR6ES-11	4824	13	LPG 2
Lantra 2	J-2	1.8	94	09.95 - 09.00	G4GM	4	1,1	BKR5ES-11	2382	33	LPG 1
Lantra D		1.9	50	98 -	XUD9A	4		Y-938R	5267	1	
Lantra 3		2.0	101	09.00 -	G4GC-G DOHC	4	1,1	BKR5ES-11	2382	33	LPG 1
Lantra 2	J-2	2.0	102	02.97 - 00		4	1,1	BKR5ES-11	2382	33	LPG 1

**MATRIX**

Matrix 1.5 CRDi	FC	1.5	60	10.01 - 02.05	D3EA	3		Y-527J	96187	67	
Matrix 1.5 CRDi	FC	1.5	75	12.04 -	D4FA	4		Y-527J	96187	67	
Matrix 1.5 CRDi VGT	FC	1.5	81	08.05 -	D4FA	4		Y-527J	96187	67	
Matrix	FC	1.6	76	08.01 -	G4ED	4	1,1	BKR5ES-11	2382	33	LPG 1
Matrix	FC	1.8	90	08.01 -	G4GB	4	1,1	BKR5ES-11	2382	33	LPG 1
Matrix	FC	1.8	98	07.01 -	G4GB	4	1,1	BKR5ES-11	2382	33	LPG 1

**PONY/EXEL**

Pony/Exel		1.3		85 - 94	G13B/G4DG	4	1,1	BPR6ES-11	4824	13	LPG 2
Pony/Exel		1.5		85 - 94	G15B/G4DJ	4	1,1	BPR6ES-11	4824	13	LPG 2
Pony/Exel		1.5		85 - 94	G15B/G4DJ Cat.	4	1,1	BPR6ES-11	4824	13	LPG 2

**S COUPÉ**

S Coupé N/A	SLC	1.5	65	04.92 - 05.96	G4EK	4	1,1	BKR5ES-11	2382	33	LPG 1
S Coupé Turbo Charge	SLC	1.5	85	04.91 - 05.98	G4EK-TC	4	0,8	BKR6ES	3783	28	LPG 1
S Coupé	SLC	1.5		92 -	G15B	4	1,1	BKR5ES-11	2382	33	LPG 1
S Coupe Turbo	SLC	1.5		92 -		4	0,8	BKR6ES	3783	28	LPG 1

**SANTA FE 1**

Santa Fe CRDI	SM	2.0	83	04.01 - 05	D4EA	4		Y-749J	5013		
Santa Fe CRDi 4x4	SM	2.0	92	08.03 -	D4EA	4		Y-749J	5013		
Santa Fe CRDi	SM	2.2	102	03.06 -	D4EB	4		Y-749J	5013		
Santa Fe CRDi	SM	2.2	110	10.05 -	D4EB	4		Y-749J	5013		
Santa Fe CRDi	SM	2.2	114	03.06 -	D4EB	4		Y-749J	5013		
Santa Fe / SM	SM	2.4	107	02.01 - 05	G4JS-G	4	1,1	PGR5C-11	5760		PGR5C-11
Santa Fe / SM	SM	2.7	127	08.00 - 12.05	G6BA-G	6	1,1	PFR5N-11	5838		PFR5N-11

**SANTA FE 2**

Santa Fe II 2.0 CRDi Euro IV	CM	2.0	110	12.10 -	D4HA	4		Y1003AS	92283		
Santa Fe II 2.0 CRDi Euro V	CM	2.0	110	12.10 -	D4HA	4		CZ105	90007		
Santa Fe II 2.4	CM	2.4	128	11.10 -	G4KC / G4KE	4	1,1	LFR5A-11	6376		LPG 7
Santa Fe II 2.7	CM	2.7	125	03.06 - 09.09	G6BA / G6EA	6	1,1	ILFR5B11	1637		ILFR6B
Santa Fe II 2.7	CM	2.7	139	11.05 - 09.09	G6BA / G6EA	6	1,1	ILFR5B11	1637		ILFR6B

**SANTAMO**

Santamo		2.0	101	99 - 12.02	G4CP DOHC / SOHC	4	1,1	BP6ES-11	1212		LPG 2
---------	--	-----	-----	------------	------------------	---	-----	----------	------	--	-------

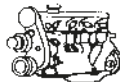

Code *l* kW

Cyl.



Stock-No.

V-TUNE

LPG/CNG

**HYUNDAI****SONATA**

Sonata 1.8i		1.8	70	89 -	G62B	4	1,1	BPR6ES-11	4824	13	LPG 2
Sonata 2.0i		2.0	74	89 - 93	4G63 DOHC	4	1,1	BPR6ES-11	4824	13	LPG 2
Sonata 2.0i		2.0	77	06.94 - 96	G4CP-D SOHC	4	1,1	BUR6EA-11	5428		
Sonata 2.0	EF	2.0	100	09.98 - 01	G4JP-G DOHC	4	1,1	BPR6ES-11	4824	13	LPG 2
Sonata 2.0 CRDI		2.0	103	02.06 -	D4EA	4	█	Y-749J	5013		
Sonata 2.0i		2.0		93 - 98	G4CP-D DOHC	4	1,1	BPR6ES-11	4824	13	LPG 2
Sonata 2.4i	NF	2.4	118	89 - 01	G4KC	4	1,1	BKR5ES-11	2382	33	LPG 1
Sonata 2.4i		2.4	120	89 -	4G64	4	1,1	BPR6ES-11	4824	13	LPG 2
Sonata 2.4i		2.4	121	08 -		4	1,1	BKR5ES-11	2382	33	LPG 1
Sonata VI 2.4	YF	2.4	131	01.09 -	G4KC	4	1,1	LFR5A-11	6376		LPG 7
Sonata 2.5 V6		2.5	118	09.98 - 01	G6BV-EG DOHC	6	1,1	PFR5J-11	4642		PFR5J-11
Sonata 2.7 V6		2.7	127	10.01 - 11.04	G6BA-G	6	1,1	PFR5B-11	2300		PFR6B
Sonata 3.0 V6		3.0		91 - 98	G6AT	6	1,1	PGR5A-11	3573		PGR6A
Sonata 3.3 V6	NF	3.3	173	01.05 - 08	G6DB	6	1,1	IFR5G11	7854		
Sonata 3.3		3.3	184			6	1,1	IFR5G11	7854		

**STAREX**

Starex	H1	2.4	82	02.98 -	SOHC	4	1,1	BP6ES-11	1212		LPG 2
Starex 2.5TD	H1	2.5	59	06.97 -		4	█	Y-722JS	9974		

**TERRACAN**

Terracan 2.5TD	HP	2.5	74	06.01 -	D4BH	4	█	CY57	4994	21	
Terracan CRDI	HP	2.9	110	10.01 -		4	█	CY57	4994	21	
Terracan	HP	2.9	120	11.03 -	J3	4	█	CY57	4994	21	

**TIBURON**

Tiburon 1.6		1.6		00 -	DOHC	4	1,1	BKR5ES-11	2382	33	LPG 1
Tiburon 1.8		1.8		00 -	DOHC	4	1,1	BKR5ES-11	2382	33	LPG 1
Tiburon 2.0		2.0		00 -	DOHC	4	1,1	BKR5ES-11	2382	33	LPG 1

**TRAJET**

Trajat 2.0 CRDI	FO	2.0	83	04.01 - 04	4DEA	4	█	Y-749J	5013		
Trajat 2.0	FO	2.0	100	05.00 -	G4JP-G DOHC	4	1,1	BPR6ES-11	4824	13	LPG 2
Trajat 2.0	FO	2.0	103	01.04 -		4	1,1	BKR5ES-11	2382	33	LPG 1
Trajat 2.7	FO	2.7	127	07.00 -	G6BA DOHC	6	1,1	PFR5N-11	5838		PFR5N-11

**TUCSON**

Tucson 2.0 D	JM	2.0	83	09.04 -	D4EA	4	█	Y-749J	5013		
Tucson 2.0 D	JM	2.0	103	02.06 -	D4EA	4	█	Y-749J	5013		
Tucson 2.0	JM	2.0	104	09.04 -	G4GC	4	1,1	BKR5ES-11	2382	33	LPG 1
Tucson 2.7 V6	JM	2.7	129	09.04 -	G6BA	6	1,1	PFR5N-11	5838		PFR5N-11

**XG**

XG 250 V6	XG	2.5	120	06.99 - 09.03	G6AV	6	1,1	PFR5N-11	5838		PFR5N-11
XG 300 V6	XG	3.0	138	12.98 -	G6CT	6	1,1	PFR5N-11	5838		PFR5N-11
XG 350 V6	XG	3.5	145	10.02 - 09.05	G6CU	6	1,1	PFR5N-11	5838		PFR5N-11

**INFINITI**

EX 35	J50	3.5	221	10.08 - 12.10	VQ35HR	6	1,1	DF7H-11B	1317		
EX 37	J50	3.7	235	09.10 -	VQ37VHR	6	1,1	DF8H-11B	1305		
FX 35	S50	3.5	206	05 -	VQ35DE V6	6	1,1	PLFR5A-11	6240		LPG 7
FX 37	S51	3.7	235	10.08 -	VQ37VHR	6	1,1	DF8H-11B	1305		
FX 45	S50	4.5	233	04 -	VK45DE V8	8	1,1	PLFR5A-11	6240		LPG 7
FX 50	S51	5.0	287	10.08 -	VK50VE	8	1,1	DF7H-11B	1317		

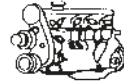
Code *l* kW

Cyl.



Stock-No.



LPG/CNG

**INFINITI**

G 20		2.0		91 - 94	SR20DE	4	1,1	PFR5B-11	2300		PFR6B
G 20		2.0		95 - 96	SR20DE	4	1,1	PFR5B-11	2300		PFR6B
G 20		2.0		99 -	SR20DE	4	1,1	PFR5G-11	2647		PFR6G-11
G 25	V36	2.5	163	01.11 -	VQ25HR	6	1,1	DF7H-11B	1317		
G 37	V36	3.7	235	10.08 -	VQ37VHR	6	1,1	DF8H-11B	1305		
G 37	V36	3.7	243	10.08 -	VQ37VHR	6	1,1	DF8H-11B	1305		
I 30		3.0		96 - 99	VQ30DE V6	6	1,1	PFR5G-11	2647		PFR6G-11
J 30		3.0		93 - 97	VG30DE V6	6	1,1	PFR5G-11	2647		PFR6G-11
M 30		3.0		90 - 92	VG30E	6	1,1	PFR6B-11	4014		PFR7B
M 35 Hybrid	Y51HV	3.5	225	04.11 -	VQ35HR	6	1,1	DF7H-11B	1317		
M 35 Hybrid	Y51HV	3.5	268	01.10 -	VQ35HR	6	1,1	DF7H-11B	1317		
M 37	Y51	3.7	235	03.10 -	VQ37VHR	6	1,1	DF8H-11B	1305		
Q 45		4.1		97 - 98	VH41DE	8	1,1	PFR5G-11	2647		PFR6G-11
Q 45		4.5		90 - 93	VH45D	8	1,1	PFR5B-11	2300		PFR6B
Q 45		4.5		94 - 96	VH45DE	8	1,1	PFR5G-11	2647		PFR6G-11
QX 56		5.6		08 -	VK56DE FI	8	1,1	LFR5A-11	6376		LPG 7
QX 4		3.3		97 - 98	VG33E	6	1,1	BKR5ES-11	2382	33	LPG 1
QX 4		3.3		99 -	VD33DE	6	1,0	FR5AP-10	5463		
QX 4		3.5		01 -	VQ35DE	6	1,1	PLFR5A-11	6240		LPG 7

**INNOCENTI**

Clip ie		1.0	35	09.95 - 06.97	146C7.000	4	0,9	BPR5ES	7422	6	LPG 2
Clip ie Super		1.4	51	09.95 - 06.97	160A1.046	4	0,8	BPR6ES	7822	2	LPG 2
Elba		1.3	49	07.91 - 08.93	146A5.000	4	0,8	BPR6ES	7822	2	LPG 2
Elba D		1.7	42	09.92 -	146 B 2.000	4	█	Y-924J	7906	1	
Elba ie		1.4	49	11.95 - 06.97	146C5.000	4	0,8	BPR6ES	7822	2	LPG 2
Elba ie		1.6	55	11.95 - 06.97	146C6.000	4	0,8	BPR6ES	7822	2	LPG 2
Elba ie Happy		1.6	55	06.95 - 06.96	146C6.000	4	0,8	BPR6ES	7822	2	LPG 2
Koral 45		0.9	33	10.90 - 06.97	100GL 064	4	0,8	BPR6ES	7822	2	LPG 2
Koral 55		1.1	41	10.90 - 06.97	128A 064	4	0,8	BPR6ES	7822	2	LPG 2
Mille		1.0	35	07.94 - 06.97	146C7.000	4	0,7	BP6ES	7811	4	LPG 2
Mille i.		1.0	35	07.94 - 06.97	146C7.000	4	0,9	BPR5ES	7422	6	LPG 2
Small 500 L / LS		0.6	23	01.91 - 06.97	Daihatsu E	3	0,9	BPR6EY	6427		LPG 2
Small 990 SE		1.0	38	01.91 - 06.97	Daihatsu CB	3	0,8	BPR5EY	2828	9*	LPG 2

**ISUZU**

Rodeo		3.2	151	98 -	V DOHC	6	1,1	PFR5G-11	2647		PFR6G-11
Trooper		2.3	66	01.87 -	4ZD1 Cat.	4	1,1	BPR6ES-11	4824	13	LPG 2
Trooper		2.3		87 -		4	0,8	BPR6ES	7822	2	LPG 2
Trooper		2.3		88 -	4ZD1	4	0,8	BPR6ES	7822	2	LPG 2
Trooper		2.6	85	10.87 -	4ZE1 Cat.	4	1,1	BPR6ES-11	4824	13	LPG 2
Trooper TD		2.8	71	10.87 - 12.91	4JB1T	4	█	Y-904M	4334		
Trooper TD		2.8	78	10.88 - 12.91	4JB1TC	4	█	Y-904M	4334		
Trooper TD		3.1	83	06.92 -	4JG2T	4	█	Y-711J	4467	28	
Trooper		3.5	158	04.00 -	6VE1 V6	6	1,1	PFR6B-11	4014		PFR7B
Vehicross 3.2 24V		3.2	158	03.97 -	6VDI	6	1,1	BKR6E-11	2756	14	LPG 1

**IVECO**

Daily TDi		2.8	90	09.97 -		6	█	Y-502R	3852		
-----------	--	-----	----	---------	--	---	---	--------	------	--	--

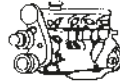
Code *l* kW

Cyl.



Stock-No.

V6/V8  
LPG/CNG**JAGUAR**

Double Six		5.3		90 -	V 12 HE	12	0,6	BR7EF	3346		
Sovereign 3.2		3.2		07.90 - 07.97	AJ6	6	0,8	BCPR6ES	2330	12	LPG 3
Sovereign 4.0		4.0		09.89 - 09.97	AJ6	6	0,8	BCPR6ES	2330	12	LPG 3

**F-TYPE**

F-Type 5.0		5.0	364	10.12 -	AJ-V8	8	1,0	ILKAR7C10	94940		
------------	--	-----	-----	---------	-------	---	-----	-----------	-------	--	--

**S-TYPE**

S-Type 2.7 D		2.7	152	06.04 -		6		YE12	7794		
S-Type 4.2 V8		4.2		03.02 -	AJ-V8	8	1,0	IFR5N10	7866		
S-Type R		4.2		03.02 -	AJ28	8	1,0	IFR5N10	7866		
S-Type R		4.2		03.02 -	AJ-V8	8	1,0	IFR5N10	7866		
S-Type 2.5		2.5	143	02.01 -	AJV6	6	1,3	TR6AP-13E	4968		LPG 5
S-Type 3.0		3.0	175	10.98 -	FC AJ-V6	6	1,3	TR6AP-13E	4968		LPG 5
S-Type V8		4.0	203	10.98 - 03.00	GC AJ-V8	8	1,3	PFR5G-13E	2761		
S-Type V8		4.0	203	03.00 - 03.02	GC AJ-V8	8	1,1	PFR5G-11E	3000		

**XF**

XF 4.2		4.2	219	03.08 -	AJ33	8	1,0	IFR5N10	7866		
XF 4.2 Supercharged		4.2	306	03.08 -	AJ33	8	1,0	IFR5N10	7866		
XF 2.7 D		2.7	152	03.08 -		6		YE12	7794		
XF 3.0		3.0	175	03.08 -	AJV6	6	1,3	TR6AP-13E	4968		LPG 5
XF 5.0		5.0	283	03.09 -	AJ133	8	1,0	ILKAR7C10	94940		ILKAR7C10
XFR 5.0 Supercharged		5.0	375	03.09 -	AJ133	8	1,0	ILKAR7C10	94940		ILKAR7C10
XJ 5.0		5.0	283	01.10 -	AJ133	8	1,0	ILKAR7C10	94940		ILKAR7C10
XJ 5.0 Supercharged		5.0	346	01.10 -	AJ133	8	1,0	ILKAR7C10	94940		ILKAR7C10
XJ 5.0 Supercharged		5.0	375	01.10 -	AJ133	8	1,0	ILKAR7C10	94940		ILKAR7C10

**XJ12**

XJ12		5.3		91 - 93	HE(V12)	12	0,6	BR7EF	3346		
XJ12		6.0		92 - 11.94	V12	12	0,6	BR7EF	3346		
XJ12		6.0		93 - 11.94	HE(V12)	12	0,6	BR7EF	3346		
XJ12		6.0		11.94 - 09.96	HE(V12)	12	0,6	BR6EF	3177		
XJ12		6.0		11.94 - 09.96	V12	12	0,6	BR6EF	3177		

**XJ6**

XJ6		3.2		07.90 - 07.97	AJ6 Cat./ 9BPMNA	6	0,8	BCPR6ES	2330	12	LPG 3
XJ6 V12		5.3		01.91 -	V12	12	0,6	BR7EFS	1094		
XJ6		3.6	136	08.86 - 05.92	AJ6 / 9DPANA	6	0,8	BCPR6ES	2330	12	LPG 3
XJ6 2.7 TDVi		2.7	152	10.05 -		6		YE12	7794		
XJ6 3.0		3.0		03.03 -	AJ-V6	6	1,3	TR6AP-13E	4968		LPG 5
XJ6		4.0		09.89 - 09.97	AJ6 Cat.	6	0,8	BCPR6ES	2330	12	LPG 3

**XJ8**

XJ8		3.2	174	09.97 - 09.98	V8	8	1,3	BKR6EVXA-13	2563		
XJ8		3.2	176	09.97 -		8	1,3	BKR6EVXA-13	2563		
XJ8		3.2		09.97 - 09.98	AJ26	8	1,3	BKR5EVXA-13	1188		
XJ8		3.2		09.98 - 03.00	AJ26	8	1,3	PFR5G-13E	2761		
XJ8		3.2		03.00 - 03.02	AJ26	8	1,1	PFR5G-11E	3000		
XJ8		3.2		03.02 -	AJ26	8	1,0	IFR5N10	7866		
XJ8		4.2	219	03.03 - 06.06	AJ33	8	1,0	IFR5N10	7866		
XJ8 Supercharged		4.2	291	03.03 - 09.09	AJ33	8	1,0	IFR5N10	7866		
XJ8		4.2		03.02 -	AJ26	8	1,0	IFR5N10	7866		
XJ8		3.5	190	03.03 - 06.06	AJ33	8	1,0	IFR5N10	7866		
XJ8		3.5		03.02 -	AJ26	8	1,0	IFR5N10	7866		

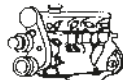
Code *l* kW

Cyl.



Stock-No.



LPG/CNG

**JAGUAR****XJ8**

XJ8		4.0	209	09.97 -	V8	8	1,3	BKR6EVXA-13	2563		
XJ8		4.0		09.97 - 09.98	AJ26	8	1,3	BKR5EVXA-13	1188		
XJ8		4.0		09.98 - 03.00	AJ26	8	1,3	PFR5G-13E	2761		
XJ8		4.0		03.00 - 03.02	AJ26	8	1,1	PFR5G-11E	3000		
XJ8		4.0		03.02 -	AJ26	8	1,0	IFR5N10	7866		

**XJ8R**

XJ8R 4.2		4.2		03.02 -		8	1,0	IFR5N10	7866		
XJ8R		4.0	272	09.97 - 03.00		8	1,3	PFR6G-13E	2341		
XJ8R Supercharged		4.0		09.97 - 02.00	AJ26	8	1,3	PFR6G-13E	2341		
XJ8R 4.0		4.0		03.00 - 03.02	AJ26	8	1,1	PFR5G-11E	3000		
XJ8R		4.0		03.02 -	AJ26	8	1,0	IFR5N10	7866		
XJR Supercharged X300		4.0	235	08.94 - 08.97	AJ16 Kompressor	6	0,9	BKR7E	6097		BKR8EIX
XJR 4.0		4.0		09.89 - 09.94	AJ6	6	0,8	BCPR6ES	2330	12	LPG 3
XJR V8 (X300)		4.0	267	09.97 - 02.00	AJ26	8	1,3	PFR6G-13E	2341		

**XJS**

XJS		5.3		91 - 93	V12 HE	12	0,6	BR7EF	3346		
XJS 3.6		3.6		08.86 - 05.91	AJ6	6	0,8	BCPR6ES	2330	12	LPG 3
XJS Coupe		4.0		04.91 - 09.96	AJ6	6	0,8	BCPR6ES	2330	12	LPG 3
XJS V12		6.0		05.93 - 11.94	V12	12	0,6	BR7EF	3346		
XJS V12		6.0		11.94 - 05.95	V12	12	0,6	BR6EF	3177		

**XK8**

XK8		4.2		09.02 -	AJ34	8	1,0	IFR5N10	7866		
XK8		4.0	213	10.96 - 09.97	AJ / V8	8	1,1	BKR6EVXA-11	6838		
XK8		4.0	213	09.97 - 09.98	AJ26	8	1,3	BKR5EVXA-13	1188		
XK8		4.0	389	10.96 - 09.97	AJ26	8	1,1	BKR6EVXA-11	6838		
XK8		4.0		09.97 - 09.98	AJ27	8	1,3	BKR5EVXA-13	1188		
XK8		4.0		09.98 - 03.00	AJ26	8	1,3	PFR5G-13E	2761		
XK8		4.0		09.98 - 03.00	AJ27	8	1,3	PFR5G-13E	2761		
XK8		4.0		03.00 -	AJ26	8	1,1	PFR5G-11E	3000		
XK8		4.0		03.00 - 02.02	AJ27	8	1,1	PFR5G-11E	3000		
XK8		4.0		03.02 -	AJ27	8	1,0	IFR5N10	7866		
XK8 5.0		5.0	283	01.09 -	AJ133	8	1,0	ILKAR7C10	94940		ILKAR7C10

**XKR**

XKR		4.2		09.02 -	AJ34	8	1,0	IFR5N10	7866		
XKR		4.0	267	05.98 - 03.00	AJ27	8	1,3	PFR6G-13E	2341		
XKR		4.0	267	03.00 - 02.02	AJ27	8	1,1	PFR5G-11E	3000		
XKR		4.0		03.02 -	AJ27	8	1,0	IFR5N10	7866		
XKR 5.0 Supercharged		5.0	375	01.09 -	AJ133	8	1,0	ILKAR7C10	94940		ILKAR7C10
XKR 5.0 Supercharged		5.0	390	09.10 -	AJ133	8	1,0	ILKAR7C10	94940		ILKAR7C10
XKR-S 5.0 Supercharged		5.0	405	01.11 -	AJ133	8	1,0	ILKAR7C10	94940		ILKAR7C10

**X-TYPE**

X-Type 2.2 D		2.2	114	10.05 -	L J46G	4		YE08	4966		
X-Type 2.5		2.5	140	02.01 -	AJ-V6	6	1,3	TR6AP-13E	4968		LPG 5
X-Type 2.0 D		2.0	96	07.03 - 10.05	R4-X404	4		Y-548J	94832	75	
X-Type 2.0		2.0	117	12.01 -	AJ-V6	6	1,3	TR6AP-13E	4968		LPG 5
X-Type 3.0		3.0	173	02.01 -	AJ-V6	6	1,3	TR6AP-13E	4968		LPG 5



Code *l* kW

Cyl.

Stock-No.  
**VEFINE**  
BY-PROMOTER

LPG/CNG

**JEEP****CHEROKEE**

Cherokee		2.5		90 - 98	L4 MPI P	4	0,9	FR5-1	7252		
Cherokee 2.4	KJ	2.4	108	08.01 -	ED1	4	1,1	LZTR4A-11	5444		
Cherokee 2.5 CRD	KJ	2.5	105	09.01 - 10.02	ENJ	4	█	Y1031J	95970	71	
Cherokee 2.8 CRD	KJ	2.8	110	09.02 - 09.04	ENR	4	█	Y1031J	95970	71	
Cherokee 2.8 CRD	KJ	2.8	120	11.04 - 04.08	ENR	4	█	Y1031J	95970	71	
Cherokee 3.7 V6	KJ	3.7	155	10.01 -	EKG	6	1,1	ZFR5F-11	2262		LPG 6
Cherokee TD		2.1	59	01.88 -		6	█	Y-908R	4585	1	
Cherokee TD		2.1	65	01.87 - 01.91	Renault J8S 814, J8S 890	4	█	Y-908R	4585	1	
Cherokee TD		2.1	65	02.91 - 08.94	J8S 890	4	█	Y-913M	3965	15	
Cherokee TD		2.5	85	05.95 - 07.99	VM HR 425	4	█	Y-741U	6943	20	

**COMMANCHE**

Commanche		2.5		91 - 92	L4 MPI P	4	0,9	FR5-1	7252		
Commanche		4.0		91 - 92	L6 MPI S	6	0,9	FR5-1	7252		

**COMMANDER**

Commander 3.0 CRD		3.0	160	04.06 - 12.10	EXL	6	█	Y8002AS	6287	51	
-------------------	--	-----	-----	---------------	-----	---	---	---------	------	----	--

**COMPASS**

Compass CRD		2.0	103	06 -		4	█	CZ304	9864	55	
-------------	--	-----	-----	------	--	---	---	-------	------	----	--

**GRAND CHEROKEE**

Grand Cherokee TD		2.5	88	01.93 -	VM HR 425 CLIRE	4	█	Y-923U	3380	1	
Grand Cherokee TD		2.5	88	01.93 -	VM HR-492	4	█	Y-923U	3380	1	
Grand Cherokee TD		2.5	110	04.99 -	ENC	4	█	Y-741U	6943	20	
Grand Cherokee 3.0 CRD	WH	3.0	155	05.06 - 12.10	EXL	6	█	Y8002AS	6287	51	
Grand Cherokee 3.0 CRD	WH	3.0	160	06.05 - 12.10	EXL	6	█	Y8002AS	6287	51	
Grand Cherokee TD / Limited		3.1	103	04.98 -	EXA	5	█	Y-741U	6943	20	
Grand Cherokee		3.7		05 -	V6 K FI	6	1,1	PZFR6F-11	3271		LPG 6
Grand Cherokee		4.0		91 - 98	L6 S MPI	6	0,9	FR5-1	7252		
Grand Cherokee		4.0		03 - 04	L6 S FI	6	0,8	ZFR5N	3459		
Grand Cherokee		4.7	173	02.99 - 99	V8 N MPI	8	1,1	PZFR6F-11	3271		LPG 6
Grand Cherokee		4.7		00 - 04	V8 N FI SOHC	8	1,1	PZFR6F-11	3271		LPG 6
Grand Cherokee		4.7		02 - 04	V8 J FI SOHC&H.O.	8	0,9	BKR7E	6097		BKR8EIX
Grand Cherokee		4.7		05 -	V8 N FI	8	1,1	PZFR6F-11	3271		LPG 6
Grand Cherokee		5.2		93 - 96	V8 Y MPI	8	0,9	FR4	5188		
Grand Cherokee		5.2		97 - 98	V8 Y MPI	8	0,9	FR5-1	7252		
Grand Cherokee		5.7	240	05 -	V8 2 FI	8	1,1	LZTR4A-11	5444		
Grand Cherokee		5.9		98 -	V8 MPI Z	8	1,0	FR5-1	7252		
Grand Cherokee SRT-8		6.1	313	08.06 -		8	1,3	PLZTR5A-13	4998		
Grand Voyager 2.5 Td Le		2.5	88	05.95 -	VM HR425 CLIEE	4	█	Y-741U	6943	20	
Grand Wagoneer		5.2		93 - 93	V8 MPI Y	8	0,9	FR4	5188		
Grand Wagoneer		5.9		89 - 91	V8 2Bbl 7	8	0,9	GR4	7038		GR5IX
Grand Wagoneer		5.9		97 -	V8 MPI Z	8	0,9	FR4	5188		

**LIBERTY**

Liberty		2.4		02 -	L4 1 FI	4	1,1	LZTR4A-11	5444		
Liberty		3.7		02 -	V6 K FI	6	1,1	PZFR6F-11	3271		LPG 6

**WAGONEER**

Wagoneer		2.5		91 - 92	L4 MPI P	4	0,9	FR5-1	7252		
Wagoneer		4.0		91 - 92	L6 MPI S	6	0,9	FR5-1	7252		

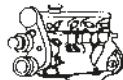
Code *l* kW

Cyl.

Stock-No.  
**VELINE**  
10-14-19-20-21-22-23-24-25-26-27-28-29-30-31-32-33-34-35-36-37-38-39-40-41-42-43-44-45-46-47-48-49-50-51-52-53-54-55-56-57-58-59-60-61-62-63-64-65-66-67-68-69-70-71-72-73-74-75-76-77-78-79-80-81-82-83-84-85-86-87-88-89-90-91-92-93-94-95-96-97-98-99-100

LPG/CNG

**JEEP  
WRANGLER**

Wrangler Laredo, Sahara, Texan TD		2.1	65	07.88 -		4		Y-908R	4585	1	
Wrangler		2.5		07.88 -		6		Y-908R	4585	1	
Wrangler,Laredo,Sahara		2.5		07.88 -		6		Y-908R	4585	1	
Wrangler, Texan D		2.5		07.88 -		6		Y-908R	4585	1	
Wrangler		2.5		91 - 01.01	L4 MPI P	4	0,9	FR5-1	7252		
Wrangler Rubicon 3.8		3.8	146	07 -	V6 FI	6	1,3	LZTR5A-13	4612		
Wrangler Unlimited		3.8	151	07 -		6	1,3	LZTR5A-13	4612		
Wrangler		4.0	135	91 -	L6 MPI	6	1,1	ZFR5A-11	5084		LPG 6
Wrangler		4.0		91 - 95	L6 MPI S	6	0,9	FR5-1	7252		
Wrangler		4.0		96 - 97	L6 MPI V	6	0,9	FR5-1	7252		
Wrangler		4.0		98 - 02	L6 MPI S	6	0,9	FR5-1	7252		

**KIA  
BESTA**

Besta		2.2	48	02.96 -	R2	4		Y-701J	1566	39	
Besta 2.2		2.2	52	03.90 - 07.99	HW	4		Y-701J	1566	39	
Besta 2.7		2.7	60	03.90 - 07.99	VN	4		Y-701J	1566	39	

**CARENS 1**

Carens 1.6	FC	1.6	77	06.02 -	S6D	4	1,1	BKR6ES-11	5553	14	LPG 1
Carens 1.8	FC	1.8	81	01 -		4	0,9	BKR6E	6962	28	LPG 1
Carens 1.8	FC	1.8	93	06.02 -	TB	4	0,8	BKR6ES	3783	28	LPG 1
Carens 2.0 CRDI EX	FC	2.0	83	02 -	D4EA	4		Y-749J	5013		

**CARENS 2**

Carens II 2.0	FJ	2.0	102	08.04 -	G4GC	4	1,1	BKR5ES-11	2382	33	LPG 1
---------------	----	-----	-----	---------	------	---	-----	-----------	------	----	-------

**CARENS 3**

Carens III 1.6 CRDi	UN	1.6	85	06.10 -	D4FB	4		Y-527J	96187	67	
Carens III 1.6 CVT	UN	1.6	93	06.09 -	G4FC	4	1,0	LZKR6B-10E	1578		
Carens III 1.6 CRDi	UN	1.6	94	07.10 -	D4FB	4		Y-527J	96187	67	
Carens III 1.6 CVT	UN	1.6	97	08.09 -	G4FC	4	1,0	LZKR6B-10E	1578		
Carens III 2.0 CRDi	UN	2.0	85	05.06 -	D4EA	4		Y-749J	5013		
Carens III 2.0 CRDi	UN	2.0	103	06 -	D4EA	4		Y-749J	5013		
Carens III 2.0	UN	2.0	106	09.06 -	G4KA	4	1,1	BKR5ES-11	2382	33	LPG 1
Carens III 2.0 CRDi	UN	2.0	136	05.06 -	D4EA	4		Y-749J	5013		

**CARNIVAL 1**

Carnival 2.5	UP	2.5	121	12.98 - 01	K5	6	1,1	PFR6N-11	3546		LPG 1
Carnival 2.5	UP	2.5	129	12.98 - 01	KV5 DOHC	6	1,1	PFR6N-11	3546		LPG 1

**CARNIVAL 2**

Carnival II 2.5	GQ	2.5	110	10.01 -		6	1,1	PFR6N-11	3546		LPG 1
Carnival II 2.7	GQ	2.7	139	06.06 -	G6EA V6	6	1,1	ILFR5B11	1637		ILFR6B

**CARNIVAL 3**

Carnival III 2.2 CRDi	VQ	2.2	110	01.10 -	D4HB	4		CZ105	90007		
Carnival III 2.2 CRDi	VQ	2.2	143	01.10 -	D4HB	4		CZ105	90007		
Carnival III 2.9 CRDi	VQ	2.9	136	06.06 -	J3	4		Y-535J	91416		

**CEE'D (ED)**

Cee'd 1.4	ED	1.4	66	07.09 -	G4FA	4	1,0	LZKR6B-10E	1578		
Cee'd 1.4	ED	1.4	80	01.07 - 12.08	G4FA	4	1,1	ZFR5F-11	2262		LPG 6
Cee'd 1.4	ED	1.4	80	01.09 -	G4FA	4	1,0	LZKR6B-10E	1578		

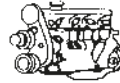
Code *l* kW

Cyl.

Stock-No.  
**V-TUNE**  
BY-PROMOTER

LPG/CNG

**KIA****CEE'D (ED)**

Cee'd 1.6 CRDi	ED	1.6	66	12.06 - 10.10	D4FB-L	4	☑	CZ203	95232	68	
Cee'd 1.6 CRDi	ED	1.6	66	11.10 -	D4FB-L	4	☑	Y-527J	96187	67	
Cee'd 1.6 CRDi	ED	1.6	85	12.06 - 10.10	D4FB	4	☑	CZ203	95232	68	
Cee'd 1.6 CRDi	ED	1.6	85	11.10 -	D4FB	4	☑	Y-527J	96187	67	
Cee'd 1.6	ED	1.6	85	09.07 -	G4FC	4	1,0	LZKR6B-10E	1578		
Cee'd 1.6	ED	1.6	90	12.06 - 12.08	G4FC	4	1,1	ZFR5F-11	2262		LPG 6
Cee'd 1.6	ED	1.6	90	01.09 -	G4FC	4	1,0	LZKR6B-10E	1578		
Cee'd 1.6 CVT	ED	1.6	92	10.10 -	G4FC	4	1,0	LZKR6B-10E	1578		
Cee'd 1.6	ED	1.6	93	09.07 - 12.08	G4FC	4	1,1	ZFR5F-11	2262		LPG 6
Cee'd 1.6	ED	1.6	93	01.09 -	G4FC	4	1,0	LZKR6B-10E	1578		
Cee'd 1.6 CRDi	ED	1.6	94	06.10 - 10.10	D4FB	4	☑	CZ203	95232	68	
Cee'd 1.6 CRDi	ED	1.6	94	11.10 -	D4FB	4	☑	Y-527J	96187	67	
Cee'd 2.0 CRDi	ED	2.0	103	01.07 -	D4EA-F	4	☑	Y-749J	5013		
Cee'd 2.0	ED	2.0	105	01.07 -	G4GC	4	0,8	BKR5ES-11	2382	33	LPG 1

**CERATO**

Cerato 1.5 CRDi	LD	1.5	75	08.04 - 08.06	D4FA	4	☑	Y-527J	96187	67	
Cerato 1.6	LD	1.6	77	05.04 -	G4ED	4	1,1	BKR5ES-11	2382	33	LPG 1
Cerato 1.6 CRDi	LD	1.6	85	06.05 - 06.08	D4FB	4	☑	Y-527J	96187	67	
Cerato 1.6	LD	1.6	90	05.06 -	G4FC	4	1,1	ZFR5F-11	2262		LPG 6
Cerato 2.0 CRDi	LD	2.0	83	04.04 -	D4EA	4	☑	Y-749J	5013		
Cerato 2.0	LD	2.0	106	05.04 -	G4GC	4	1,1	BKR5ES-11	2382	33	LPG 1

**CLARUS**

Clarus 1.8	K9A / GC	1.8	85	06.96 - 01	T8 DOHC	4	0,8	BKR5E	7938	35	LPG 1
Clarus 2.0	K9A / GC	2.0	98	09.96 - 01	FE DOHC	4	1,1	BK6E-11	7340		LPG 1

**JOICE**

Joice		2.0	103	09.01 - 03	G4CP	4	1,1	BPR6ES-11	4824	13	LPG 2
-------	--	-----	-----	------------	------	---	-----	-----------	------	----	-------

**K 2500**

K 2500		2.5	69	05 -	D4BH	4	☑	Y-722JS	9974		
--------	--	-----	----	------	------	---	---	---------	------	--	--

**K 2900**

K 2900 2.9 D		2.9	92	08.07 -	J3	4	☑	Y-535J	91416		
--------------	--	-----	----	---------	----	---	---	--------	-------	--	--

**MAGENTIS**

Magentis V6	GD	2.5	118	01 -	G6BV	6	0,8	BKR5ES	2460	35	LPG 1
Magentis V6	GD	2.5	124	03 -	G6BV	6	0,8	BKR5ES	2460	35	LPG 1
Magentis V6	MG	2.7	138	06 - 09	G6EA	6	1,1	ILFR5B11	1637		ILFR6B
Magentis	GD	2.0	100	01 - 05		4	0,8	BPR6ES	7822	2	LPG 2
Magentis CRDi	MG	2.0	103	04.06 - 09	D4EA	4	☑	Y-749J	5013		
Magentis	MG	2.0	106	06 - 09	G4KA	4	1,1	BKR5ES-11	2382	33	LPG 1
Magentis 2.0	MG	2.0	121	07.09 -	G4KD	4	1,1	LFR5A-11	6376		LPG 7

**OPIRUS**

Opirus	GH	3.8		07 -	G6DA	6	1,1	IFR5G11	7854		
Opirus	GH	3.5	149	03 - 06		6	1,1	PFR5N-11	5838		PFR5N-11

**PICANTO (BA)**

Picanto 1.0	BA	1.0	45	05.04 -	G4HE	4	1,1	BKR5ES-11	2382	33	LPG 1
Picanto 1.0	BA	1.0	46	11.09 -	G4HE	4	1,1	BKR5ES-11	2382	33	LPG 1
Picanto 1.1	BA	1.1	48	10.03 -	G4HG	4	1,1	BKR5ES-11	2382	33	LPG 1
Picanto 1.1 CRDi	BA	1.1	55	11.05 -	D3FA	3	☑	Y-527J	96187	67	

Code *l* kW

Cyl.



Stock-No.



LPG/CNG

**KIA  
PICANTO (TA)**

Picanto 1.0	TA	1.0	51	05.11 -	G3LA	3	1,0	LKR6D-10E	96569		
Picanto 1.2	TA	1.2	60	09.11 -	G4LA	4	1,0	LKR6D-10E	96569		

**PREGIO**

Pregio		2.7	60	06.96 -	J2	4	<input checked="" type="checkbox"/>	Y-701J	1566	39	
Pregio		3.0	66	06.97 -	W3 / NB9	4	<input checked="" type="checkbox"/>	Y-701J	1566	39	

**PRIDE**

Pride		1.3	44	05.95 - 01		4	1,1	BPR5ES-11	4424		LPG 2
Pride		1.3	53	05.95 - 01		4	1,1	BPR5ES-11	4424		LPG 2

**RETONA**

Retona	CE	2.0	61	04.00 -		4	<input checked="" type="checkbox"/>	Y-721J	6919		
Retona 16V	CE	2.0	94	00 -	FED	4	1,1	BKR6E-11	2756	14	LPG 1

**RIO 1**

Rio 1.3	DC	1.3	55	00 - 02		4	1,1	BPR5EY-11	3028		LPG 2
Rio 1.3	DC	1.3	60	03 -		4	1,1	BPR5ES-11	4424		LPG 2
Rio 1.5	DC	1.5	71	03 -		4	1,1	BKR6ES-11	5553	14	LPG 1
Rio 1.5	DC	1.5	72	00 - 02		4	0,9	BKR6E	6962	28	LPG 1

**RIO 2**

Rio II 1.4 16V	JB	1.4	71	06.05 -	G4EE	4	1,1	BKR5ES-11	2382	33	LPG 1
Rio II 1.5 CRDi	JB	1.5	81	06.05 -	D4FA	4	<input checked="" type="checkbox"/>	Y-527J	96187	67	
Rio II 1.6 CVT	JB	1.6	82	06.05 -	G4ED	4	1,1	BKR5ES-11	2382	33	LPG 1

**RIO 3**

Rio III 1.1 CRDi	UB	1.1	55	06.11 -	D3FA	3	<input checked="" type="checkbox"/>	Y-527J	96187	67	
Rio III 1.25 CVT	UB	1.3	63	06.11 -	G4LA	4	1,0	LKR6D-10E	96569		
Rio III 1.4 CRDi	UB	1.4	66	06.11 -	D4FC	4	<input checked="" type="checkbox"/>	Y-527J	96187	67	
Rio III 1.4 CVT	UB	1.4	80	06.11 -	G4FA	4		LZKR6B-10E	1578		

**SEDONA 1**

Sedona 2.5		2.5		09.99 -	KV6	6	1,1	PFR6N-11	3546		LPG 1
------------	--	-----	--	---------	-----	---	-----	----------	------	--	-------

**SEDONA 2**

Sedona MkII 2.2 CRDi	VQ	2.2	143	01.10 -	D4HB	4	<input checked="" type="checkbox"/>	CZ105	90007		
----------------------	----	-----	-----	---------	------	---	-------------------------------------	-------	-------	--	--

**SEPHIA**

Sephia	FA	1.5	59	96 -	B5E MMO	4	1,1	BPR5ES-11	4424		LPG 2
Sephia	FA	1.8		06.96 -		4	0,8	BKR5E	7938	35	LPG 1
Sephia 2 FB522	FB	1.6	75	04.01 -	OKAB5	4	0,9	BKR6E	6962	28	LPG 1
Sephia GTX	FA	1.6	59	09.93 -	B6 SOHC	4	1,1	BPR6ES-11	4824	13	LPG 2

**SHUMA 1**

Shuma 1 1.5	FB	1.5	65	05.98 -	BFD	4	1,1	BKR6E-11	2756	14	LPG 1
Shuma 1 1.8	FB	1.8	82	05.98 -	TED	4	0,9	BKR6E	6962	28	LPG 1

**SHUMA 2**

Shuma 2 1.6 FB522,FB624	FB	1.6	75	04.01 -	OKAB5	4	0,9	BKR6E	6962	28	LPG 1
Shuma 2 1.8	FB	1.8	82	01 -	TED	4	0,9	BKR6E	6962	28	LPG 1

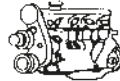

Code *l* kW

Cyl.

Stock-No.  
**VEFINE**  
BY-PROMOTER

LPG/CNG

**KIA****SORENTO 1**

Sorento 2.4	JC	2.4	75	02 -	G4JF	4	1,1	PGR5C-11	5760		PGR5C-11
Sorento 2.5 CRDi	JC	2.5	103	08.02 -		4	█	Y-508J	3709		
Sorento 3.3	JC	3.3	177	06 -	G6DB	6	1,1	IFR5G11	7854		
Sorento 3.5	JC	3.5	143	02 -	G6CU	6	1,1	PFR5N-11	5838		PFR5N-11
Sorento 3.8	JC	3.8		06 -	G6DA	6	1,1	IFR5G11	7854		

**SORENTO 2**

Sorento 2.0 CRDi	XM	2.0	110	07.09 -	D4HA	4	█	Y1003AS	92283		
Sorento 2.2 CRDi Hot Climate Zone	XM	2.2	145	11.09 -	D4HB	4	█	Y1003AS	92283		
Sorento 2.2 CRDi Cold Climate Zone	XM	2.2	145	11.09 -	D4HB	4	█	CZ105	90007		
Sorento 2.4 CVT	XM	2.4	128	11.09 -	G4KE	4	1,1	LFR5A-11	6376		LPG 7

**SOUL**

Soul 1.6 CVT	AM	1.6	77	02.09 -	G4FC	4	1,0	LZKR6B-10E	1578		
Soul 1.6 CRDi	AM	1.6	85	02.09 -	D4FB	4	█	Y-527J	96187	67	
Soul 1.6	AM	1.6	93	02.09 -	G4FC	4	1,0	LZKR6B-10E	1578		
Soul 1.6 CRDi	AM	1.6	94	02.09 -	D4FB	4	█	Y-527J	96187	67	

**SPORTAGE 1**

Sportage TD	K00	2.0	61	07.96 - 08.99	Mazda engine	4	█	Y-701J	1566	39	
Sportage	K00	2.0	70	94 - 12.02	SOHC	4	0,8	BKR5E	7938	35	LPG 1
Sportage 16V	K00	2.0	94	94 - 08.04	DOHC 16V	4	1,1	BKR6E-11	2756	14	LPG 1

**SPORTAGE 2**

Sportage 2.0	JE	2.0	83	11.04 -	D4EA	4	█	Y-749J	5013		
Sportage 2.0 CRDi	JE	2.0	103	06 -	D4EA	4	█	Y-749J	5013		
Sportage 2.0	JE	2.0	104	06 -	G4GC	4	1,1	BKR5ES-11	2382	33	LPG 1
Sportage 2.5	JE	2.5	129	09.04 -		6	1,1	BKR5ES-11	2382	33	LPG 1
Sportage 2.7	JE	2.7	129	06 -	G6BA V6	6	1,1	PFR5N-11	5838		PFR5N-11

**SPORTAGE 3**

Sportage 1.7 CRDi	SL	1.7	85	11.10 -	D4FD	4	█	CZ203	95232	68	
Sportage 2.0 CRDi 4x4 Automatik	SL	2.0	110	07.10 -	D4HA	4	█	Y1003AS	92283		
Sportage 2.0 CRDi	SL	2.0	110	07.10 -	D4HA	4	█	CZ105	90007		
Sportage 2.0 CVT	SL	2.0	120	07.10 -	G4KD	4	1,1	LFR5A-11	6376		LPG 7

**VENGA**

Venga 1.4 CRDi Euro III / Euro IV	YN	1.4	55	02.10 -	D4FC	4	█	Y-527J	96187	67	
Venga 1.4 CRDi Euro V	YN	1.4	55	02.10 -	D4FC	4	█	CZ203	95232	68	
Venga 1.4 CRDi Euro IV	YN	1.4	57	02.10 -	D4FC	4	█	Y-527J	96187	67	
Venga 1.4 CRDi Euro V	YN	1.4	57	02.10 -	D4FC	4	█	CZ203	95232	68	
Venga 1.4	YN	1.4	66	10.09 -	G4FA	4	1,0	LZKR6B-10E	1578		
Venga 1.4 CRDi Euro III / Euro IV	YN	1.4	66	02.10 -	D4FC	4	█	Y-527J	96187	67	
Venga 1.4 CRDi Euro V	YN	1.4	66	02.10 -	D4FC	4	█	CZ203	95232	68	
Venga 1.6 CRDi Euro IV	YN	1.6	85	02.10 -	D4FB	4	█	Y-527J	96187	67	
Venga 1.6 CRDi Euro V	YN	1.6	85	02.10 -	D4FB	4	█	CZ203	95232	68	
Venga 1.6	YN	1.6	92	10.09 -	G4FC	4	1,0	LZKR6B-10E	1578		
Venga 1.6 CRDi Euro IV	YN	1.6	94	02.10 -	D4FB	4	█	Y-527J	96187	67	
Venga 1.6 CRDi Euro V	YN	1.6	94	02.10 -	D4FB	4	█	CZ203	95232	68	

**LADA (AVTOVAZ)**

112 2112 16V		1.5	54	01.96 -	VAZ-2111	4	0,8	BPR6ES	7822	2	LPG 2
112 Gli		1.5	67	03 -	16V	4	1,1	BCPR6ES-11	7121	11	LPG 3

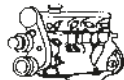
Code *ℓ* kW

Cyl.



Stock-No.



LPG/CNG

**LADA (AVTOVAZ)**

1200		1.2				4	0,8	BP5ES	6511	8	LPG 2
2101, 21011, 21012, 21013, 21014			44			4	0,7	BP6ES	7811	4	LPG 2
1.2-1.5 ltr											
2107 Lada 1300 L		1.3				4	0,7	BP6ES	7811	4	LPG 2
2107 Lada 1500 L		1.5				4	0,7	BP6ES	7811	4	LPG 2
2108 Samara / Fun 1100		1.1				4	0,7	BP6ES	7811	4	LPG 2
2108 Samara / Fun 1300		1.3				4	0,7	BP6ES	7811	4	LPG 2
2108 Samara / Fun 1500		1.5				4	0,7	BP6ES	7811	4	LPG 2
210993 Samara 1.5		1.5	53	01.90 -		4	0,8	BPR6ES	7822	2	LPG 2
210993 Samara 1.5i		1.5	57		VAZ-2111	4	1,1	BPR6ES-11	4824	13	LPG 2
2110 1,5		1.5	53	06.96 -		4	0,8	BPR6ES	7822	2	LPG 2
2110		1.5	56	96 -		4	0,8	BPR6ES	7822	2	LPG 2
2110		1.5	58	97 -		4	0,8	BPR6ES	7822	2	LPG 2
2111		1.5	58	97 -		4	0,8	BPR6ES	7822	2	LPG 2
2115 1,5		1.5	53	00.00 -		4	0,8	BPR6ES	7822	2	LPG 2
2115 1,5i		1.5	57	01.00 -	VAZ-2111	4	1,1	BPR6ES-11	4824	13	LPG 2
2120 Nadeschda 1,7i		1.7	60	01.98 -	BA3-21214	4	1,1	BPR6ES-11	4824	13	LPG 2
2120 Nadeschda 1,8		1.8	59	01.98 -	BA3-2130	4	0,8	BPR6ES	7822	2	LPG 2
Aleko D		1.8	44		Ford RTE, RTS	4		Y-910R	4751	3	
Forma		1.3		09.91 -		4	0,8	BPR6ES	7822	2	LPG 2
Forma		1.5	50	09.91 -		4	0,8	BPR6ES	7822	2	LPG 2
Forma 21099		1.5	56			4	0,8	BPR6ES	7822	2	LPG 2
Lada 2101/ 21011/ 21012/ 21013/ 21014						4	0,7	BP6ES	7811	4	LPG 2
Lada 2102/ 21021/ 21022/ 21023/ 21024/ 21026						4	0,7	BP6ES	7811	4	LPG 2
Lada 2103/ 21033/ 21035						4	0,7	BP6ES	7811	4	LPG 2
Lada 2104/ 21043/ 21046/ 21047						4	0,7	BP6ES	7811	4	LPG 2
Lada 2105/ 21051/ 21053/ 21056/ 21057						4	0,7	BP6ES	7811	4	LPG 2
Lada 2106/ 21061/ 21064/ 21065-01/ 21066						4	0,7	BP6ES	7811	4	LPG 2
Lada 2107/ 21072/ 21073/ 21074/ 21076/ 21077/ 21078/ 210736-40						4	0,7	BP6ES	7811	4	LPG 2
Lada 2108/ 21081/ 21083/ 21087/ 21088						4	0,8	BPR6ES	7822	2	LPG 2
Lada 21083i/ 21093i/ 21099i/ 21102/ 211026/ 21110/ 2131i						4	1,1	BPR6ES-11	4824	13	LPG 2
Lada 2109/ 21091/ 21093						4	0,8	BPR6ES	7822	2	LPG 2
Lada 21099						4	0,8	BPR6ES	7822	2	LPG 2
Lada 2110/ 2111						4	0,8	BPR6ES	7822	2	LPG 2
Lada 21103/ 211036/ 21113/ 21109/ 21108/ 21083-37/ 2112/ 2113/ 21103						4	1,1	BCPR6ES-11	7121	11	LPG 3
Lada 2115-01/ 2115-03/ 21153-01						4	0,8	BPR6ES	7822	2	LPG 2
Lada 2115-20/ 2115-21/ 2115-23/ 21153-21						4	1,1	BPR6ES-11	4824	13	LPG 2
Lada NIVA 4x4 2121						4	0,7	BP6ES	7811	4	LPG 2
Lada NIVA 4x4 21211/ 21212						4	0,8	BPR6ES	7822	2	LPG 2
Lada NIVA 4x4 2131/ 2130/ 2129/ 21217/ 21214/ 21213						4	0,8	BPR6ES	7822	2	LPG 2
Lada OKA 1111/ 1113						4	0,7	BCP6ES	4930	17	LPG 3
21102 i		1.5	57	01.96 -	BA3 2111	4	1,1	BPR6ES-11	4824	13	LPG 2
21103 16V		1.5	67	01.96 -	BA3 2112	4	1,1	BCPR6ES-11	7121	11	LPG 3
Lada 110 21101 8V		1.6	59	04 -	BA3 21114	4	1,1	BPR6ES-11	4824	13	LPG 2
Lada 110 21104		1.6	66	04 -	BA3 21124	4	1,1	BCPR6ES-11	7121	11	LPG 3

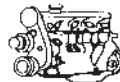
Code *l* kW

Cyl.

Stock-No.  
**VEFINE**  
BY-PROMETEX

LPG/CNG

**LADA (AVTOVAZ)**

2110 GTi 16V		2.0	110	01.96 -	C20XE Opel	4	0,9	BKR6E	6962	28	LPG 1
110 2.0 GTI		2.0	110	01.00 -	C20XE	4		BKR6EK	2288	20	LPG 1
21111		1.5	53	01.98 -	BA3 2120	4	0,8	BPR6ES	7822	2	LPG 2
21110 i		1.5	57	01.98 -	BA3 2111	4	1,1	BPR6ES-11	4824	13	LPG 2
21113 16V		1.5	67	01.98 -	BA3 2112	4	1,1	BCPR6ES-11	7121	11	LPG 3
Lada 111 21112 8V		1.6	59	04 -	BA3 21114	4	1,1	BPR6ES-11	4824	13	LPG 2
Lada 111 21114 16V		1.6	66	04 -	BA3 21124	4	1,1	BCPR6ES-11	7121	11	LPG 3
21122 i		1.5	57	01.00 -	VAZ-2111	4	1,1	BPR6ES-11	4824	13	LPG 2
21120 16V		1.5	67	01.00 -	VAZ-2112	4	1,1	BCPR6ES-11	7121	11	LPG 3
Lada 112 21121 8V		1.6	59	04 -	BA3 21114	4	1,1	BPR6ES-11	4824	13	LPG 2
Lada 112 21124 16V		1.6	66	04 -	BA3 21124	4	1,1	BCPR6ES-11	7121	11	LPG 3
2102, 21021, 21022, 21023, 21024, 21026 Lada Kombi		1.2	43		BA3 2101	4	0,7	BP6ES	7811	4	LPG 2
2102, 21021, 21022, 21023, 21024, 21026 Lada Kombi		1.3	47		BA3 21011	4	0,7	BP6ES	7811	4	LPG 2
21043 / Nova Kombi		1.5	53	01.88 -	BA3-2103	4	0,7	BP6ES	7811	4	LPG 2
21050		1.5	53	01.88 -	BA3 21011	4	0,7	BP6ES	7811	4	LPG 2
21060		1.3	47		BA3 21011	4	0,7	BP6ES	7811	4	LPG 2
21063		1.5	52		BA3 2103	4	0,7	BP6ES	7811	4	LPG 2
21073		1.5	53	01.88 -	BA3 2103	4	0,7	BP6ES	7811	4	LPG 2
Lada Kalina 1117		1.6	58	10.04 -	BA3 11183	4	1,1	BCPR6ES-11	7121	11	LPG 3
Lada Kalina 1118		1.6	58	10.04 -	BA3 11183	4	1,1	BCPR6ES-11	7121	11	LPG 3
Lada Kalina 1119		1.6	58	10.04 -	BA3 11183	4	1,1	BCPR6ES-11	7121	11	LPG 3
Lada Kalina 1117 8V		1.6	59	05 -	BA3 21114	4	1,1	BPR6ES-11	4824	13	LPG 2
Lada Kalina 1118 8V		1.6	59	05 -	BA3 21114	4	1,1	BPR6ES-11	4824	13	LPG 2
Lada Kalina 1119 8V		1.6	59	05 -	BA3 21114	4	1,1	BPR6ES-11	4824	13	LPG 2
Lada Kalina 1117 16V		1.6	65	10.04 -	BA3 21124	4	1,1	BCPR6ES-11	7121	11	LPG 3
Lada Kalina 1118 16V		1.6	65	10.04 -	BA3 21124	4	1,1	BCPR6ES-11	7121	11	LPG 3
Lada Kalina 1119 16V		1.6	65	10.04 -	BA3 21124	4	1,1	BCPR6ES-11	7121	11	LPG 3
Lada Niva 2129 1.7 Niva		1.7	59	93 -	BA3 21213	4	0,8	BPR6ES	7822	2	LPG 2
2105 Nova Junior		1.2				4	0,7	BP6ES	7811	4	LPG 2
2105 Nova 1300		1.3				4	0,7	BP6ES	7811	4	LPG 2
2105 Nova Spezial		1.5				4	0,7	BP6ES	7811	4	LPG 2
21091		1.1	39	01.87 -		4	0,8	BPR6ES	7822	2	LPG 2
21090		1.3	48	01.87 -	BA3 2108	4	0,8	BPR6ES	7822	2	LPG 2
21099		1.3	48	01.90 -	BA3 2108	4	0,8	BPR6ES	7822	2	LPG 2
21093		1.5	53	01.87 -	BA3 2103	4	0,8	BPR6ES	7822	2	LPG 2
Lada Samara 2113 8V		1.5	56	04 -	BA3 2111	4	1,1	BPR6ES-11	4824	13	LPG 2
21083 i		1.5	57		BA3 2111	4	1,1	BPR6ES-11	4824	13	LPG 2
21093 i		1.5	57		BA3 2111	4	1,1	BPR6ES-11	4824	13	LPG 2
2114 i		1.5	57	01.01 -	BA3 2111	4	1,1	BPR6ES-11	4824	13	LPG 2
2107 Toscana		1.5	55	07.88 -		4	0,7	BP6ES	7811	4	LPG 2
21213 Niva 1.7		1.7	55	01.93 -		4	0,8	BPR6ES	7822	2	LPG 2
21214 Niva 1.7i		1.7	60	01.01 -	BA3-21214	4	1,1	BPR6ES-11	4824	13	LPG 2
Niva		1.7	59	95 -		4	0,8	BPR6ES	7822	2	LPG 2
21310 Niva 1.7i		1.7	60	01.95 -	BA3-21214	4	1,1	BPR6ES-11	4824	13	LPG 2
21312 Niva 1.8		1.8	59	01.95 -	BA3-2130	4	0,8	BPR6ES	7822	2	LPG 2
Niva D		1.9	47	10.93 -	Peugeot XUD 9L	4		Y-924J	7906	1	
Nova / Vaz 2104, 2105			55	07.88 -		4	0,8	BPR6ES	7822	2	LPG 2
Nova / Vaz 2107			57	07.88 -		4	0,8	BPR6ES	7822	2	LPG 2
Nova / Vaz 21051		1.2	44	07.88 -		4	0,8	BPR6ES	7822	2	LPG 2
Nova / Vaz 2102, 2105		1.3	48	07.88 -		4	0,8	BPR6ES	7822	2	LPG 2

Code *l* kW

Cyl.



Stock-No.



LPG/CNG

**LADA (AVTOVAZ)**

Nova / Vaz 21043		1.5	55	07.88 -		4	0,8	BPR6ES	7822	2	LPG 2
Nova i		1.7	59	11.94 -		4	0,8	BPR6ES	7822	2	LPG 2
Nova i		1.7	62	11.94 -		4	0,8	BPR6ES	7822	2	LPG 2
1111 Oka / 640		0.65	22	09.89 -	BA3 1111	2	0,7	BCP6ES	4930	17	LPG 3
Oka /640		0.65	22	09.89 -	Vaz 1111	2	0,7	BCP6ES	4930	17	LPG 3
1111 Oka 1.3		1.3	46	01.98 -	A-Plus ROV	4	0,8	BPR6ES	7822	2	LPG 2
Oka 1.3 VAZ-1111		1.3	46	01.98 -	A-Plus ROV	4	0,8	BPR6ES	7822	2	LPG 2
Sagona D		1.5	40	01.95 -	TUD5	4	█	Y-503J	1009	10	
Sagona i		1.5		07.94 -		4	0,9	BPR5ES	7422	6	LPG 2
Sagona GLX		1.5		07.95 -		4	0,8	BPR6ES	7822	2	LPG 2
Samara Fun		1.1	39	09.91 -		4	0,8	BPR6ES	7822	2	LPG 2
Samara / Vaz 2108		1.1	41	07.88 -		4	0,8	BPR6ES	7822	2	LPG 2
Samara / Vaz 2108		1.3	46	07.88 -		4	0,8	BPR6ES	7822	2	LPG 2
Samara D		1.5	40	01.95 -	TUD 5	4	█	Y-503J	1009	10	
Samara 21093		1.5	56			4	0,8	BPR6ES	7822	2	LPG 2
Samara Sport		1.5	65	96 -		4	0,8	BPR6ES	7822	2	LPG 2

**LAMBORGHINI**

Gallardo Coupé		5.0	382	05.05 -	L140	10	0,8	PFR7G	4364		PFR7G
Gallardo Spider		5.0	382	05.05 -	L140	10	0,8	PFR7G	4364		PFR7G
Gallardo Coupé Superleggera		5.0	390	06.07 -	L140	10	0,8	PFR7G	4364		PFR7G
Murciélago Coupé		6.5	471	04.06 -	L537	12		KR8BI	4347		KR8BI
Murciélago LP640 Coupe / Roadster		6.5	471	07 -	L537	12		KR8BI	4347		KR8BI

**LANCIA****DEDRA**

Dedra 1.6L i.e.		1.6	57	08.89 - 09.94	835A1046 Cat.	4	0,8	BPR6ES	7822	2	LPG 2
Dedra 1.6L - LE/S.W. LE		1.6	66	10.94 - 02.98	159B9000	4	0,9	BCPR7ES	3330		BCPR7EIX
Dedra 1.6		1.6	66	03.97 - 02.98	159B9000	4	0,9	BCPR7ES	3330		BCPR7EIX
Dedra 1.6i.e. S.W. 16V		1.6	76	03.98 - 01.00	182A4000	4	0,9	BKR5EZ	7642	36	LPG 1
Dedra 1.6i.e. 16V		1.6	76	03.98 - 01.00	182A4000	4	0,9	BKR5EZ	7642	36	LPG 1
Dedra 1.8L - LE-LS-SW		1.8	74	10.94 - 02.98	835A2046	4	0,9	BCPR7ES	3330		BCPR7EIX
Dedra i.e./ LE		1.8	77	01.89 - 09.94	835A2046 Cat.	4	0,8	BPR7ES	2023	19	BPR8EIX
Dedra 1.8- 16V		1.8	83	07.97 - 01.00	182A2000	4		BKR6EKC	2848	26	LPG 1
Dedra TD		1.9	66	03.89 - 09.94	835A4000	4	█	Y-924J	7906	1	
Dedra TD ds		1.9	66	10.94 -	160D1000	4	█	Y-922R	4356	1	
Dedra Eco LE TD		1.9	68	06.93 -	160D1000	4	█	Y-922R	4356	1	
Dedra i.e. / LS		2.0	83	01.89 - 09.94	835A5046 Cat.	4	0,8	BPR7ES	2023	19	BPR8EIX
Dedra i.e. automatica LS		2.0	83	10.94 - 04.97	835A5046	4	0,8	BPR7ES	2023	19	BPR8EIX
Dedra 2.0L-16V- S.W.LX / integrale		2.0	102	10.94 - 02.98	836A3000	4	0,8	BPR7ES	2023	19	BPR8EIX
Dedra 2000 Turbo		2.0	119	08.91 - 02.98	835A8046	4		BP6ET	1263		LPG 2
Dedra i.e. Turbo/Integr.		2.0	124	01.91 - 09.94	835A7046 Cat.	4		BP6ET	1263		LPG 2

**DELTA**

Delta / LX		1.3	57	- 93	831A...- 831B.000	4	0,8	BPR7ES	2023	19	BPR8EIX
Delta 1.4 T-JET 120CV		1.4	88	08 -	198A4000	4	0,8	IKR9J8	93311		IKR9J8
Delta 1.4 T-JET 150CV		1.4	110	08 -	198A1000	4	0,8	IKR9J8	93311		IKR9J8
Delta / LX / Automatic		1.5	59	- 93	831A...- 831B.000	4	0,8	BPR7ES	2023	19	BPR8EIX
Delta		1.6	55	09.93 - 11.97	851C1000	4	0,9	BCPR7ES	3330		BCPR7EIX
Delta (836)		1.6	66	03.96 - 02.98	182A6000	4	0,9	BCPR7ES	3330		BCPR7EIX
Delta 16V - HPE		1.6	76	06.96 - 11.97	182A4000	4		BKR6EKC	2848	26	LPG 1



Code *l* kW

Cyl.



Stock-No.

LPG/CNG

**LANCIA****DELTA**

Delta 1.6i.e. 16V HPE; LS		1.6	76	12.97 - 02.98	182A4000	4		BKR6EKC	2848	26	LPG 1
Delta		1.6	76	03.98 - 01.00	182A4000	4	0,9	BKR5EZ	7642	36	LPG 1
Delta GT		1.6	77	- 93	831A4000	4	0,8	BPR7ES	2023	19	BPR8EIX
Delta i.e. GT		1.6	77	- 93	182A4000 Cat.	4	0,8	BPR6ES	7822	2	LPG 2
Delta i.e. / Turbo HF		1.6	95	- 93	831A7000 Cat.	4	0,8	BPR7ES	2023	19	BPR8EIX
Delta i.e. / LE		1.8	66	09.93 - 11.97	835C4000	4	0,8	BPR7ES	2023	19	BPR8EIX
Delta 16V/ HPE		1.8	96	06.96 - 11.97	183A1000	4		BKR6EKC	2848	26	LPG 1
Delta 1.8- 16V- HPE/LS		1.8	96	12.97 - 01.00	183A1000	4		BKR6EKC	2848	26	LPG 1
Delta TD		1.9	59	06.86 - 06.91	831D1000	4	█	Y-924J	7906	1	
Delta HPE TD		1.9	66	10.94 -	160D1000	4	█	Y-922R	4356	1	
Delta TD ds		1.9	66	10.94 -	160D1000	4	█	Y-922R	4356	1	
Delta TD- ds LE		1.9	66	10.94 -	160D1000	4	█	Y-922R	4356	1	
Delta TD LS		1.9	66	10.94 -	160D1000	4	█	Y-922R	4356	1	
Delta HPE Td		1.9	66	10.96 -		4	█	Y-928U	4389	29	
Delta i.e. 16V / LS		2.0	102	09.93 - 11.97	836A3000	4	0,8	BPR7ES	2023	19	BPR8EIX
Delta i.e. 16V GT		2.0	102	10.94 - 11.97	836A3000	4	0,8	BPR7ES	2023	19	BPR8EIX
Delta HPE ie		2.0	102	06.95 -		4	0,8	BPR7ES	2023	19	BPR8EIX
Delta i.e. HPE Turbo 16V		2.0	137	01.93 - 09.96	836A2000	4	0,8	BPR7ES	2023	19	BPR8EIX
Delta Turbo		2.0	137	09.93 - 11.97	836A2000	4		BP6ET	1263		LPG 2
Delta HPE Turbo 16V HF		2.0	137	06.95 -		4		BUR6ET	3172	1	LPG 2
Delta i.e. HPE Turbo 16V HF		2.0	142	12.97 - 01.00	175A4000	4		BCPR6ET	2197		LPG 3
Delta i.e. Turbo HF 16V Inte		2.0	144	10.87 - 11.97	831C5000	4	0,8	BPR7ES	2023	19	BPR8EIX
Delta HF Integrale Evo 3		2.0	144	07.92 - 11.97	831C5046	4		BP6ET	1263		LPG 2
Delta i.e. Turbo HF Integr.		2.0	144	07.92 - 11.97	831C5046	4	0,8	BPR7ES	2023	19	BPR8EIX
Delta HF integrale Spec.ed.		2.0	155	02.94 - 11.97	831E5046	4		BUR6ET	3172	1	LPG 2

**DELTA III**

Delta 3 1.4 T-Jet	844	1.4	88	09.08 -	198A4000	4	0,8	IKR9J8	93311		IKR9J8
Delta 3 1.4 T-Jet LPG	844	1.4	88	10.09 -	198A4000	4	0,8	IKR9J8	93311		IKR9J8
Delta 3 1.4 T-Jet	844	1.4	103	07.10 -	198A7000	4	0,8	IKR9J8	93311		IKR9J8
Delta 3 1.4 T-Jet	844	1.4	110	09.08 -	198A1000	4	0,8	IKR9J8	93311		IKR9J8
Delta 3 1.6 D Mjet	844	1.6	77	04.11 -	844A3000	4	█	Y9003AS	94251	78	
Delta 3 1.6 D Mjet	844	1.6	85	09.08 -	955A4000	4	█	Y9003AS	94251	78	
Delta 3 1.6 D Mjet	844	1.6	88	07.08 -	198A2000	4	█	Y9003AS	94251	78	
Delta 3 1.8 Di TURBO-JET	844	1.8	147	05.09 -	939B1000	4	0,6	ILKAR7D6G	93607		ILKAR7D6G
Delta 3 1.9 D MJet	844	1.9	140	09.08 -	844A1000	4	█	Y9003AS	94251	78	
Delta 3 2.0 D MJet	844	2.0	120	09.08 -	844A2000	4	█	Y9003AS	94251	78	
Delta 3 2.0 D Mjet	844	2.0	121	07.08 -	198A5000	4	█	Y9003AS	94251	78	

**KAPPA (K)**

K		2.0	114	11.94 - 02.01	838A6000	4		BKR6EKC	2848	26	LPG 1
K		2.0	114	07.98 - 02.01	838A6000	4		BCPR6ET	2197		LPG 3
K 20V LS; S.W.		2.0	114	07.98 - 02.01	838A6000	5		BKR6EKC	2848	26	LPG 1
K turbo		2.0	151	02.95 - 06.98	838A4000	4		BP6ET	1263		LPG 2
K Turbo 16V Coupé		2.0	151	07.97 - 06.98	838A4000	4		BP6ET	1263		LPG 2
K i. 20V LS/LE/LX/SW		2.4	129	01.95 - 02.01	838A2000	5		BKR6EKC	2848	26	LPG 1
K i 20V Coupé		2.5	129	07.97 - 02.01	838A2000	5		BKR6EKC	2848	26	LPG 1
K V6 - 24V-LX/LS/SW/coupé		3.0	150	01.95 - 02.01	838B000	6	0,9	PFR6B	3500		PFR7B
K i V6 24V aut. Coupé		3.0	150	07.97 - 02.01	838B000	6	0,9	PFR6B	3500		PFR7B
KAPPA 2000 20V 150CV		2.0	110	01.95 -	838A1000	5		BKR6EKC	2848	26	LPG 1
KAPPA 2000 16V TURBO		2.0	151	02.95 - 02.01	838A4000	4		BP6ET	1263		LPG 2
KAPPA 2000 TURBO 20V		2.0	162	07.98 - 02.01	175A3000	5		BKUR6ET	6437	27	LPG 1

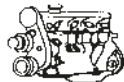
Code *l* kW

Cyl.

Stock-No.  
**V-LINE**  
10-15-20-25-30-35-40-45-50-55-60-65-70-75-80-85-90-95-100-105-110-115-120-125-130-135-140-145-150-155-160-165-170-175-180-185-190-195-200-205-210-215-220-225-230-235-240-245-250-255-260-265-270-275-280-285-290-295-300-305-310-315-320-325-330-335-340-345-350-355-360-365-370-375-380-385-390-395-400-405-410-415-420-425-430-435-440-445-450-455-460-465-470-475-480-485-490-495-500-505-510-515-520-525-530-535-540-545-550-555-560-565-570-575-580-585-590-595-600-605-610-615-620-625-630-635-640-645-650-655-660-665-670-675-680-685-690-695-700-705-710-715-720-725-730-735-740-745-750-755-760-765-770-775-780-785-790-795-800-805-810-815-820-825-830-835-840-845-850-855-860-865-870-875-880-885-890-895-900-905-910-915-920-925-930-935-940-945-950-955-960-965-970-975-980-985-990-995-1000

LPG/CNG

**LANCIA  
KAPPA (K)**

KAPPA / SW / Coupé 2,4 JTD		2.4	100	06.98 - 10.99	838A8000 fino a n. motore —> 1713818	5		Y-747U	4694	26	
KAPPA / SW / Coupé 2,4 JTD		2.4	100	11.99 - 04	838A8000 dal n. motore 1713819 —>	5		Y-534J	3413	36	
KAPPA 2400 20V 175CV		2.4	129	01.95 - 02.01	838A2000	5		BKR6EKC	2848	26	LPG 1
KAPPA TD		2.4		10.94 - 12.98	838A3000	5		Y-910J	3617	3	
KAPPA 3000 V6 24V		3.0	150	01.95 - 02.01	838B000	6	0,9	PFR6B	3500		PFR7B

**LYBRA**

Lybra 16V;Lx;S.W.		1.6	76	09.99 -	182A4000	4	0,9	BKR5EZ	7642	36	LPG 1
Lybra 16V;Lx;S.W.		1.8	96	09.99 - 08.02	839A4000	4		BKR6EKC	2848	26	LPG 1
Lybra 16V;Lx;S.W.		1.8	96	09.02 -	839A4000	4	0,9	BKR6EZ	4619	38	LPG 1
Lybra 1.9 JTD		1.9	77	09.98 - 11.99	AR32302 fino a n. motore —> 1713818	4		Y-747U	4694	26	
Lybra 1.9 JTD		1.9	77	12.99 - 09.00	AR32302 dal n. motore 1713819 —>	4		Y-534J	3413	36	
Lybra 1.9 JTD		1.9	81	09.00 - 05.01	AR 37101	4		Y-534J	3413	36	
Lybra 1.9 JTD		1.9	85	06.01 - 04	937A2000	4		Y-534J	3413	36	
Lybra 20V;Lx;S.W.;Aut.		2.0	110	09.99 - 08.02	182B7000	5		BKR6EKC	2848	26	LPG 1
Lybra 20V;Lx;S.W.;Aut.		2.0	110	09.02 -	182B7000	5	0,9	BKR6EZ	4619	38	LPG 1
Lybra 2.4 JTD		2.4	100	11.99 - 12.00	AR 32501 dal n. motore 1713819 —>	5		Y-534J	3413	36	
Lybra 2.4 JTD		2.4	100	09.99 - 11.99	AR 32501 fino a n. motore —> 1713818	5		Y-747U	4694	26	
Lybra 2.4 JTD		2.4	103	09.00 - 05.02	839A6000	5		Y-534J	3413	36	
Lybra 2.4 JTD		2.4	110	05.02 - 04	841C000	5		Y-534J	3413	36	

**MUSA**

Musa 1.3 D Mjet EURO IV		1.3	51	09.04 - 12.12	188A9000	4		Y8003J	97256	62	
Musa 1.3 D Mjet EURO V		1.3	51	11 - 12.12	188A9000	4		Y9001AS	97719	72	
Musa 1.3 D Mjet		1.3	66	02.05 -	199A3000	4		Y8003J	97256	62	
Musa 1.3 D Mjet EURO V		1.3	66	11 -	199A3000	4		Y9001AS	97719	72	
Musa 1.3 D Mjet EURO V		1.3	70	03.09 -	199B1000	4		Y9001AS	97719	72	
Musa 1.4		1.4	57	09.05 -	350A1000	4	1,0	ZKR7A-10	1691		LPG 8
Musa 1.4 LPG EURO IV		1.4	57	04.09 -	350A1000	4	1,0	ZKR7A-10	1691		LPG 8
Musa 1.4 LPG EURO V		1.4	57	11.10 -	350A1000	4	0,8	ZKR7AI-8	92402		ZKR7AI-8
Musa 1.4 16V		1.4	66	10.04 - 12.12	192B2000	4	1,0	DCPR7E-N-10	4983		LPG 8
Musa 1.4 16V		1.4	70	09.04 - 02.05	843A1000	4	0,9	DCPR7E-N	4795		LPG 8
Musa 1.4 16V		1.4	70	03.05 -	843A1000	4	1,0	DCPR7E-N-10	4983		LPG 8
Musa 1.6 D Mjet		1.6	85	07.08 - 12.12	350A3000	4		Y9003AS	94251	78	
Musa 1.6 D Mjet		1.6	88	06.08 -	350A2000	4		Y9003AS	94251	78	
Musa 1.9 D Mjet		1.9	73	10.04 - 12.12	188B2000	4		Y-534J	3413	36	

**PHEDRA**

Phedra JTD		2.0	79	09.02 - 05.03	RHM (DW10ATED4) fino a n. ric. —> 9666	4		Y-504J	1441	24	
Phedra JTD		2.0	80	09.02 -	DW10ATED4/RHT, RHW	4		Y-504J	1441	24	
Phedra JTD		2.0	80	09.02 - 05.03	RHW (DW10ATED4) fino a n. ric. —> 9666	4		Y-504J	1441	24	
Phedra 2.0		2.0	100	10.02 -	RFN	4	0,9	LFR5B	7113		LPG 7
Phedra 2.2 JTD		2.2	94	09.02 - 05.03	4HW (DW12ATED4) fino a n. ric. —> 9666	4		Y-504J	1441	24	
Phedra 2.2 JTD		2.2	94	06.03 -	DW12ATED4/4HW	4		Y-504J	1441	24	

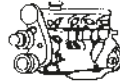
Code *l* kW

Cyl.



Stock-No.

LPG/CNG

**LANCIA****PHEDRA**

Phedra 2.2 JTD		2.2	120	04.06 - 11.10	4HP / 4HR	4	<input checked="" type="checkbox"/>	YE08	4966		
Phedra 2.2 D Mjet		2.2	125	02.08 - 11.10	4HT / 4HS	4	<input checked="" type="checkbox"/>	YE08	4966		
Phedra 3,0 V6		3.0	150	10.02 -	XFW	6	1,1	PLFR5A-11	6240		LPG 7

**THEMA**

Thema i.e. / Wagon		2.0	85	- 01.95	834B.146 Cat.	4	0,8	BPR7ES	2023	19	BPR8EIX
Thema i.e. 16V Tur. SW/LS/LX		2.0	108	- 01.95	834B2000	4		BP6ET	1263		LPG 2
Thema i.e. Turbo SW		2.0	110	- 01.95	834C146 Cat.	4	0,8	BPR7ES	2023	19	BPR8EIX
Thema 16V / LE / LS		2.0	112	- 01.95	834F1000 Cat.	4	0,8	BPR7ES	2023	19	BPR8EIX
Thema i.e. 16V S.W. Fairway		2.0	112	04.94 - 01.95	834F1000	4	0,8	BPR7ES	2023	19	BPR8EIX
Thema i.e. Turbo		2.0	122	- 01.95	834C146	4	0,8	BPR7ES	2023	19	BPR8EIX
Thema Turbo 16V LS/LX		2.0	132	- 01.95	834C1000	4		BP6ET	1263		LPG 2
Thema i.e. Turbo 16V LX		2.0	148	10.91 - 01.95	834F2000 Cat.	4		BP6ET	1263		LPG 2
Thema i.e. Turbo 16V		2.0	148	04.94 -		4		BP6ET	1263		LPG 2
Thema i.e. Turbo 16V S.W.Fairway		2.0	148	04.94 - 01.95	834C1246	4		BUR6ET	3172	1	LPG 2
Thema TD		2.4	74	01.93 -		4	<input checked="" type="checkbox"/>	Y-914U	2643	1	
Thema TD		2.5	85	01.94 - 12.94			<input checked="" type="checkbox"/>	Y-926U	7119		
Thema i.e. V6		2.8	110	- 01.95	PRV834AB Cat.	6	1,0	BPR6EFS	3623	7	LPG 5
Thema i.e. V6 LS / LX / SW		3.0	126	92 - 01.95	834F.000	6	0,8	BPR7ES	2023	19	BPR8EIX
Thema 8.32		3.0	150	90 - 92	F105L Cat.	8	0,7	DCPR9E	2641		

**THESIS**

Thesis 2.0 20V TB		2.0	136	11.02 -	841E000	5		BKUR6ETB	6992		
Thesis 2.0 TB cambio 6 marce		2.0	136	11.02 -	841E000	5		BKUR6ETB	6992		
Thesis 2.4 JTD		2.4	110	07.02 - 04.03	841C000	5	<input checked="" type="checkbox"/>	Y-534J	3413	36	
Thesis 2.4 JTD 20V		2.4	120	05.03 - 10.03	841M000 / 841N000	5	<input checked="" type="checkbox"/>	YE07	6092		
Thesis 2.4 20V		2.4	125	11.02 -	841D000	5	0,9	BKR6EZ	4619	38	LPG 1
Thesis 2.4 JTD 20V		2.4	129	05.03 - 06.09	841G000 / 841H000	5	<input checked="" type="checkbox"/>	YE07	6092		
Thesis 2.4 D Mjet 20V		2.4	136	09.05 - 06.09	841P000	5	<input checked="" type="checkbox"/>	YE07	6092		
Thesis 3.0 24V V6		3.0	158	11.02 -	841A000	6	0,9	PFR6B	3500		PFR7B
Thesis 3.2 24V V6		3.2	169	11.03 -	841A000	6	0,9	PFR6B	3500		PFR7B

**Y**

Y 1.2 8V: Vanity- LS-Unica		1.2	44	10.00 - 12.03	188A4000	4	0,9	BKR5EZ	7642	36	LPG 1
Y 1.2 16V- LS-LX-Unica		1.2	59	10.00 - 11.02	188A5000	4	0,9	DCPR8E-N	5692		LPG 8
Y 1.2 16V- LS-LX-Unica		1.2	59	12.02 - 12.03	188A5000	4	0,9	DCPR7E-N	4795		LPG 8
Y 10 4WD		1.0	33	85 - 10.96	156A2246	4	0,8	BCPR6ES	2330	12	LPG 3
Y 10 Fire		1.0	33	85 - 10.96	156A2000	4	0,8	BCPR6ES	2330	12	LPG 3
Y 10 Selectronic i.e.		1.1	37	- 10.96	156C046 Cat.	4	0,8	BCPR6ES	2330	12	LPG 3
Y 10 /4x4		1.1	37	09.86 - 10.96	156C046	4	0,6	BCPR7ES	3330		BCPR7EIX
Y Elefantino Blu		1.1	40	05.97 - 04.00	176B2000	4	0,9	BKR6E	6962	28	LPG 1
Y Elefantino Blu		1.1	40	05.97 - 09.00	176B2000	4	0,8	BCPR6ES	2330	12	LPG 3
Y 8V		1.2	44	01.96 - 03.97	840A3000	4	0,8	BCPR6ES	2330	12	LPG 3
Y 8V LS,LE;ECVT		1.2	44	01.96 - 10.99	840A3000	4	0,8	BCPR6ES	2330	12	LPG 3
Y 8V Elefantino Blu -unica		1.2	44	10.99 - 09.03	188A4000	4	0,9	BKR5EZ	7642	36	LPG 1
Y 16V elefantino Blu /Rosso		1.2	59	10.00 - 11.02	188A5000	4	0,9	DCPR8E-N	5692		LPG 8
Y 16V		1.2	63	04.97 - 03.00	176B9000	4	0,9	DCPR8E	4339		LPG 8
Y 16V,LE,LS,LX, Elefantino Rosso		1.2	63	04.97 - 04.00	176B9000	4	0,9	DCPR8E	4339		LPG 8
Y 16V LE		1.2	63	02.98 - 09.00	176B9000	4	0,9	DCPR8E	4339		LPG 8
Y 10 1300; G.T.		1.3	53	11.87 - 10.96	146A5046	4	0,8	BPR6ES	7822	2	LPG 2
Y		1.4	55	01.96 - 12.97		4		BCPR6ET	2197		LPG 3
Y i. 12V		1.4	55	01.96 - 01.98	840A2000 - 4000	4		BKR6EKC	2848	26	LPG 1
Y i.e. 12V		1.4	59	01.96 - 01.98	840A4000	4		BKR6EKC	2848	26	LPG 1

Code *l* kW

Cyl.

Stock-No.  
**VELINE**  
10-11-12-13-14-15-16-17-18-19-20-21-22-23-24-25-26-27-28-29-30-31-32-33-34-35-36-37-38-39-40-41-42-43-44-45-46-47-48-49-50-51-52-53-54-55-56-57-58-59-60-61-62-63-64-65-66-67-68-69-70-71-72-73-74-75-76-77-78-79-80-81-82-83-84-85-86-87-88-89-90-91-92-93-94-95-96-97-98-99-100-101-102-103-104-105-106-107-108-109-110-111-112-113-114-115-116-117-118-119-120-121-122-123-124-125-126-127-128-129-130-131-132-133-134-135-136-137-138-139-140-141-142-143-144-145-146-147-148-149-150-151-152-153-154-155-156-157-158-159-160-161-162-163-164-165-166-167-168-169-170-171-172-173-174-175-176-177-178-179-180-181-182-183-184-185-186-187-188-189-190-191-192-193-194-195-196-197-198-199-200-201-202-203-204-205-206-207-208-209-210-211-212-213-214-215-216-217-218-219-220-221-222-223-224-225-226-227-228-229-230-231-232-233-234-235-236-237-238-239-240-241-242-243-244-245-246-247-248-249-250-251-252-253-254-255-256-257-258-259-260-261-262-263-264-265-266-267-268-269-270-271-272-273-274-275-276-277-278-279-280-281-282-283-284-285-286-287-288-289-290-291-292-293-294-295-296-297-298-299-300-301-302-303-304-305-306-307-308-309-310-311-312-313-314-315-316-317-318-319-320-321-322-323-324-325-326-327-328-329-330-331-332-333-334-335-336-337-338-339-340-341-342-343-344-345-346-347-348-349-350-351-352-353-354-355-356-357-358-359-360-361-362-363-364-365-366-367-368-369-370-371-372-373-374-375-376-377-378-379-380-381-382-383-384-385-386-387-388-389-390-391-392-393-394-395-396-397-398-399-400-401-402-403-404-405-406-407-408-409-410-411-412-413-414-415-416-417-418-419-420-421-422-423-424-425-426-427-428-429-430-431-432-433-434-435-436-437-438-439-440-441-442-443-444-445-446-447-448-449-450-451-452-453-454-455-456-457-458-459-460-461-462-463-464-465-466-467-468-469-470-471-472-473-474-475-476-477-478-479-480-481-482-483-484-485-486-487-488-489-490-491-492-493-494-495-496-497-498-499-500-501-502-503-504-505-506-507-508-509-510-511-512-513-514-515-516-517-518-519-520-521-522-523-524-525-526-527-528-529-530-531-532-533-534-535-536-537-538-539-540-541-542-543-544-545-546-547-548-549-550-551-552-553-554-555-556-557-558-559-560-561-562-563-564-565-566-567-568-569-570-571-572-573-574-575-576-577-578-579-580-581-582-583-584-585-586-587-588-589-590-591-592-593-594-595-596-597-598-599-600-601-602-603-604-605-606-607-608-609-610-611-612-613-614-615-616-617-618-619-620-621-622-623-624-625-626-627-628-629-630-631-632-633-634-635-636-637-638-639-640-641-642-643-644-645-646-647-648-649-650-651-652-653-654-655-656-657-658-659-660-661-662-663-664-665-666-667-668-669-670-671-672-673-674-675-676-677-678-679-680-681-682-683-684-685-686-687-688-689-690-691-692-693-694-695-696-697-698-699-700-701-702-703-704-705-706-707-708-709-710-711-712-713-714-715-716-717-718-719-720-721-722-723-724-725-726-727-728-729-730-731-732-733-734-735-736-737-738-739-740-741-742-743-744-745-746-747-748-749-750-751-752-753-754-755-756-757-758-759-760-761-762-763-764-765-766-767-768-769-770-771-772-773-774-775-776-777-778-779-780-781-782-783-784-785-786-787-788-789-790-791-792-793-794-795-796-797-798-799-800-801-802-803-804-805-806-807-808-809-810-811-812-813-814-815-816-817-818-819-820-821-822-823-824-825-826-827-828-829-830-831-832-833-834-835-836-837-838-839-840-841-842-843-844-845-846-847-848-849-850-851-852-853-854-855-856-857-858-859-860-861-862-863-864-865-866-867-868-869-870-871-872-873-874-875-876-877-878-879-880-881-882-883-884-885-886-887-888-889-890-891-892-893-894-895-896-897-898-899-900-901-902-903-904-905-906-907-908-909-910-911-912-913-914-915-916-917-918-919-920-921-922-923-924-925-926-927-928-929-930-931-932-933-934-935-936-937-938-939-940-941-942-943-944-945-946-947-948-949-950-951-952-953-954-955-956-957-958-959-960-961-962-963-964-965-966-967-968-969-970-971-972-973-974-975-976-977-978-979-980-981-982-983-984-985-986-987-988-989-990-991-992-993-994-995-996-997-998-999-1000

LPG/CNG

**LANCIA  
YPSILON (843)**

Ypsilon 1.2 8V	843	1.2	44	09.03 - 10.04	188A4000	4	0,9	BKR5EZ	7642	36	LPG 1
Ypsilon 1.2	843	1.2	44	10.04 -	188A4000	4	1,0	DCPR7E-N-10	4983		LPG 8
Ypsilon 1.2	843	1.2	51	09.10 -	169A5000	4	1,0	ZKR7A-10	1691		LPG 8
Ypsilon 16V	843	1.2	57	09.03 - 02.05	188A5000	4	0,9	DCPR7E-N	4795		LPG 8
Ypsilon 16V	843	1.2	57	02.05 -	188A5000	4	1,0	DCPR7E-N-10	4983		LPG 8
Ypsilon MJT	843	1.3	51	10.03 - 06	188A4000	4		Y8003J	97256	62	
Ypsilon 1.3 D Mjet EURO IV	843	1.3	55	09.06 -	199A2000	4		Y8003J	97256	62	
Ypsilon 1.3 D Mjet EURO V	843	1.3	55	11 -	199A2000	4		Y9001AS	97719	71	
Ypsilon 1.3 D Mjet	843	1.3	66	09.06 -	199A3000	4		Y8003J	97256	62	
Ypsilon 1.3 D Mjet	843	1.3	77	09.07 -	199A3000	4		Y8003J	97256	62	
Ypsilon 1,4	843	1.4	57	09.06 -	350A1000	4	1,0	ZKR7A-10	1691		LPG 8
Ypsilon 1.4 LPG	843	1.4	57	04.09 -	350A1000	4	1,0	ZKR7A-10	1691		LPG 8
Ypsilon 1.4 16V	843	1.4	70	09.03 - 02.05	843A1000	4	0,9	DCPR7E-N	4795		LPG 8
Ypsilon 1.4 16V	843	1.4	70	02.05 -	843A1000	4	1,0	DCPR7E-N-10	4983		LPG 8

**YPSILON (846)**

Ypsilon 0.9 Twinair	846	0.9	63	05.11 -	312A2000	2	0,8	ILKR9G8	97168		ILKR9G8
Ypsilon 1.2 LPG	846	1.2	49	05.11 -	169A4000	4	0,8	ZKR7AI-8	92402		ZKR7AI-8
Ypsilon 1.2	846	1.2	51	05.11 -	169A4000	4	1,0	ZKR7A-10	1691		LPG 8
Ypsilon 1.3 D Multijet	846	1.3	70	05.11 -	199B1000	4		Y9001AS	97719	72	

**ZETA**

Zeta TD		1.9	68	04.95 -	XUD 9TE	4		Y-924J	7906	1	
Zeta i.e.		2.0	89	04.99 - 12.01	RFV	4		BKR5EK	7956	23	LPG 1
Zeta 2.0 16V		2.0	100	07.00 - 09.02	RFN	4	0,9	LFR5B	7113		LPG 7
Zeta i.e. Turbo,LS		2.0	108	10.94 - 03.99	RGX	4		BKR6EK	2288	20	BKR6EQU
Zeta TD		2.1	80	07.96 -	XUD11ATE	4		Y-923U	3380	1	

**LAND ROVER  
COUNTRY**

Country TD		2.5	83	01.89 -		4		Y-909R	4602		
------------	--	-----	----	---------	--	---	--	--------	------	--	--

**DEFENDER**

Defender TDI		2.5	83	11.89 - 10.98	200/300 Gemini 1	4		Y-729U	4119	34	
Defender 2.5 Td5		2.5	90	11.98 - 09.07	Td5	4		Y-605J	4309		
Defender TDI 90 & 110		2.5	102	01.99 -		4		Y-924J	7906	1	
Defender 2.5		2.5		90 -		6	0,8	BP6ES	7811	4	LPG 2
Defender 3.5 V8		3.5		90 -		8	0,9	BPR5ES	7422	6	LPG 2

**DISCOVERY**

Discovery TDi ES		2.5	83	09.89 -		4		Y-729U	4119	34	
Discovery TDI		2.5	83	09.89 - 01.99	200/300 Gemini 1	4		Y-729U	4119	34	
Discovery TDi Vogue ES		2.5	90	10.93 - 08.98		4		Y-729U	4119	34	
Discovery 2.5 Td5		2.5	102	09.98 - 08.04	Td5	4		Y-605J	4309		
Discovery V8		3.5	107	09.89 - 01.99	V8 3.5	8	0,8	BPR6ES	7822	2	LPG 2
Discovery V8		3.9	136	02.99 -	V8	8	0,8	BPR6ES	7822	2	LPG 2
Discovery 2.0		2.0	99	06.93 - 01.99	Mpi	4	0,9	BKR6E	6962	28	LPG 1
Discovery		4.0		94 - 99		8	0,8	BPR6ES	7822	2	LPG 2
Discovery		4.0		10.98 -		8	1,1	PFR6N-11	3546		LPG 1
Discovery 3 4.4		4.4	220	07.04 - 10.08		8	1,0	IFR5N10	7866		



Code *l* kW

Cyl.

Stock-No.  
**VEFINE**  
BY-PROMOTER

LPG/CNG

**LAND ROVER****FREELANDER 1**

Freelander 1.8		1.8	87	97 -	K SERIES	4	1,1	PFR6N-11	3546		LPG 1
Freelander 2.0 TD		2.0	71	10.97 - 08.98	20 T2R	4	█	Y-730U	6704	17	
Freelander 2.0 TD4		2.0	80	08.98 -	M47D20 (BMW)	4	█	Y-507J	2691	32	
Freelander 2.0		2.0		01 -	KV6	6	1,1	PFR6N-11	3546		LPG 1
Freelander 2.5 Tdi		2.5	102	05.98 -		5	█	Y-924J	7906	1	
Freelander 2.5 V6		2.5	130	09.00 -	KV6	6	1,1	PFR6N-11	3546		LPG 1

**FREELANDER 2**

Freelander 2 2.2 TD4 to chassis no. AH999999		2.2	110	08.10 -	DW12BTED4	4	█	YE08	4966		
Freelander 2 2.2 TD4 to chassis no. AH999999		2.2	112	01.07 -	224DT	4	█	YE08	4966		
Freelander 2 2.2 TD4 to chassis no. AH999999		2.2	118	10.06 -	224DT	4	█	YE08	4966		
Freelander 2 2.2 SD4 to chassis no. AH999999		2.2	140	08.10 -		4	█	YE08	4966		

**RANGE ROVER**

Range Rover		4.2		10.92 - 12.94	V8	8	0,8	BPR6ES	7822	2	LPG 2
Range Rover		4.4	210	09.99 -	BMW M62 B44	8		BKR6EQUP	3199	30	LPG 1
Range Rover		2.5	66	04.86 - 10.92	VM UNIT (NOT GEMINI ENG.)	4	█	Y-909R	4602		
Range Rover TDI		2.5	83	01.86 - 12.94	ETC 9091 N	4	█	Y-729U	4119	34	
Range Rover Vogue TD		2.5	87	01.90 - 09.94	VM 425 SLIRR	4	█	Y-923U	3380	1	
Range Rover Vogue TD		2.5	87	01.90 - 09.94	VM HR-492	4	█	Y-923U	3380	1	
Range Rover		2.5	100	09.94 -	M51 D25 (BMW)	6	█	Y-924J	7906	1	
Range Rover		2.5		09.89 -	200/300 Gemini 1	4	█	Y-729U	4119	34	
Range Rover		4.6	160	01.99 -		8	1.1	PFR6N-11	3546		LPG 1
Range Rover		4.6	165	09.94 - 10.98	V8	8	0,8	BPR6ES	7822	2	LPG 2
Range Rover		3.9	127	11.88 - 10.95	V8	8	0,8	BPR6ES	7822	2	LPG 2
Range Rover 3		3.0	130	03.02 -	M57 D30 BMW	6	█	Y-507J	2691	32	
Range Rover 3		3.0		02 -	M57 D30 (BMW)	6	█	Y-507J	2691	32	
Range Rover		4.0	131	01.99 - 02		8	1,1	PFR6N-11	3546		LPG 1
Range Rover		4.0		09.94 - 12.98		8	0,8	BPR6ES	7822	2	LPG 2

**RANGE ROVER 4**

Range Rover 4 4.2 Supercharged		4.2	291	05.05 -	AJ41	8	1,0	IFR5N10	7866		
Range Rover 4 4.4		4.4	225	05.05 -	AJ41	8	1,0	IFR5N10	7866		
Range Rover 4 5.0		5.0	276	09.09 -	AJ133	8	1,0	ILKAR7C10	94940		ILKAR7C10
Range Rover 4 5.0 Supercharged		5.0	375	09.09 -	AJ133	8	1,0	ILKAR7C10	94940		ILKAR7C10

**RANGE ROVER SPORT**

Range Rover Sport 4.2 Supercharged		4.2	287	02.05 -	AJ41	8	1,0	IFR5N10	7866		
Range Rover Sport 4.4		4.4	220	02.05 -	AJ41	8	1,0	IFR5N10	7866		
Range Rover Sport 5.0		5.0	276	07.09 -	AJ133	8	1,0	ILKAR7C10	94940		ILKAR7C10
Range Rover Sport 5.0 Supercharged		5.0	372	01.10 -	AJ133	8	1,0	ILKAR7C10	94940		ILKAR7C10
Range Rover Sport 5.0 Supercharged		5.0	375	09.09 -	AJ133	8	1,0	ILKAR7C10	94940		ILKAR7C10

**LEXUS****CT**

CT 200h Hybrid	ZWA10	1.8	73	12.10 -	ZZR-FXE	4	1,1	ILKAR7B11	4912		
----------------	-------	-----	----	---------	---------	---	-----	-----------	------	--	--

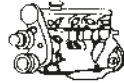
Code *ℓ* kW

Cyl.

Stock-No.  
**VLIVE**  
10-1470000000000

LPG/CNG

**LEXUS  
ES**

ES 300	MCV20	3.0		01.00 - 03	2JZ-GE	6		BKR6EKP-11	3452		
ES 300	MCV30	3.0		01.04 -	1MZ-FE	6	1,1	IFR6T11	4589		IFR6T11

**GS**

GS 250	GRL11	2.5	154	03.12 -	4GR-FSE	6	1,1	DFH6B-11A	1501		
GS 300	JZS147	3.0	156	93 - 99	2JZ-GE	6	1,1	BKR5EP-11	3440		LPG 1
GS 300	JZS160 / UZS161	3.0	161	01.02 -	2JZ-GE	6	1,1	BKR6EP-11	2978		LPG 1
GS 300		3.0	163	97 -	2TZ-GE	6		BKR6EKP-11	3452		
GS 300	UZS190 / GRS190	3.0	170	04.05 -	3GR-FE	6	1,1	DFH6B-11A	1501		
GS 300	UZS190 / GRS190	3.0	183	04.05 - 08.07	3GR-FSE	6	1,1	DFH6B-11A	1501		
GS 300	UZS190 / GRS190	3.0	183	09.07 -	3GR-FSE	6	1,1	ILFR6T11	4904		ILFR6T11
GS 300	JZS160	3.0		01.00 -	1MZ-FE	6		BKR6EKP-11	3452		
GS 300	UZS190 / GRS190	3.0		05.05 -	3GR-FSE	6	1,1	IFR6T11	4589		IFR6T11
GS 430	JZS160 / UZS161	4.3	208	01.02 -	3UZ-FE	6	1,1	IFR6T11	4589		IFR6T11
GS 430	GRS190	4.3	208	08.05 -	3UZ-FE	8	1,1	IFR6T11	4589		IFR6T11
GS 430	UZS190	4.3	208	08.05 -	3UZ-FE	8	1,1	IFR6T11	4589		IFR6T11
GS 450h Hybrid	GWS191	3.5	218	02.06 - 11.11	2GR-FSE	6	1,1	DFH6B-11A	1501		
GS 450h Hybrid	GWS191	3.5	254	02.06 - 11.11	2GR-FSE	6	1,1	DFH6B-11A	1501		
GS 460	URS190	4.6	255	09.07 -	1UR-FSE	8	1,1	DFH6B-11A	1501		

**IS**

IS 200	GXE10	2.0	114	01.00 -	1G-FE	6	1,1	IFR6T11	4589		IFR6T11
IS 250	GSE20	2.5	153	08.05 -	4GR-FSE	6	1,1	DFH6B-11A	1501		
IS 300	GXE10/ JCE10/15	2.0	114	09.01 -	1G-FE	6	1,1	IFR6T11	4589		IFR6T11
IS 300	GXE10/ JCE10/15	3.0		01.02 -	2JZ-GE	6	1,1	BKR6EP-11	2978		LPG 1

**IS C**

IS C	GSE20	2.5	153	04.09 -	4GR-FSE	6	1,1	DFH6B-11A	1501		
------	-------	-----	-----	---------	---------	---	-----	-----------	------	--	--

**ISF**

IS-F	USE20	5.0	311	11.07 -	2UR-GSE	8	1,1	DFH6B-11A	1501		
------	-------	-----	-----	---------	---------	---	-----	-----------	------	--	--

**LS**

LS 400		4.0	180	90 - 94	1UZ-FE Cat.	8	1,1	BKR6EP-11	2978		LPG 1
LS 400		4.0	194	10.94 - 12.99	1UZ-FE	8	0,8	BKR6EP-8	2215		LPG 1
LS 400		4.0		06.90 - 06.97	1UAZ-FE	8	1,1	BKR5EP-11	3440		LPG 1
LS 400	UCF20	4.0		01.00 -	1UZ-FE	8	1,1	IFR6T11	4589		IFR6T11
LS 430	UCF30	4.3	207	08.00 -	3UZ-FE with TWC	8	1,1	IFR6T11	4589		IFR6T11
LS 430	UCF30	4.3		08.00 -	3UZ-FE without TWC	8	0,8	BKR6EYA	2249		LPG 1
LS 460	USF40 / 41	4.6		09.06 -	1UR-FE	8	1,1	ILFR6T11	4904		ILFR6T11

**LX**

LX 470	UZJ100	4.7		01.00 -	2UZ-FE with TWC	8	1,1	IFR6T11	4589		IFR6T11
LX 470	UZJ100	4.7		01.00 -	2UZ-FE without TWC	8	0,8	BKR6EYA	2249		LPG 1

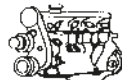
Code *l* kW

Cyl.



Stock-No.



LPG/CNG

**LEXUS****RX**

RX 300	MCU10	3.0	148	01.98 - 02.03	1MZ-FE	6	1,1	IFR6T11	4589		IFR6T11
RX 300	MCU15	3.0	150	07.00 - 06	1MZ-FE	6	1,1	IFR6T11	4589		IFR6T11
RX 300	MCU35 / 38	3.0		01.04 - 06	1MZ-FE	6	1,1	IFR6T11	4589		IFR6T11
RX 300	MCU35 / 38	3.3		01.04 - 06	3MZ-FE	6	1,1	IFR6T11	4589		IFR6T11
RX 330	MCU35 / 38	3.0		01.04 -	1MZ-FE	6	1,1	IFR6T11	4589		IFR6T11
RX 330	MCU35 / 38	3.3	171	04.03 - 01.06	3MZ-FE	6	1,1	IFR6T11	4589		IFR6T11
RX 400 h	MHU38	3.3	155	03.05 -	3MZ-FE	6	1,1	IFR6T11	4589		IFR6T11

**SC 430**

SC 430	UZZ40	4.3	210	05.01 -	3UZ-FE	8	1,1	IFR6T11	4589		IFR6T11
--------	-------	-----	-----	---------	--------	---	-----	---------	------	--	---------

**LOTUS**

Elan SE 16V Turbo		1.6		10.89 -		4	0,8	BKR6E	6962	28	LPG 1
Elan 1.6 16V		1.6		10.89 -		4	1,1	BKR6E-11	2756	14	LPG 1
Elise		1.8	88	96 -	K- SERIES (Including) VVC	4	1,1	PFR6N-11	3546		LPG 1
Elise 111S		1.8	107	99 -		4	1,1	PFR6N-11	3546		LPG 1
Esprit 2.0 Turbo 16V GT3		2.0		10.96 -		4	0,8	BPR6EKN	1128		
Esprit Turbo SE		2.2	197	89 -	910S	4	0,6	BPR6EKN	1128		
Esprit Turbo		2.2		87 -		4	0,8	BPR6ES	7822	2	LPG 2
Esprit S4		2.2		93 - 07.96		4	0,6	BPR6EKN	1128		
Esprit Sport 300		2.2		93 -		4	0,6	BPR6EKN	1128		
Esprit SE 2.2		2.2		11.94 - 07.96	Cat.	4	0,8	BPR6EKN	1128		
Esprit		3.5	260	96 -	918	8		BKR6EKC	2848	26	LPG 1
Excel SA / SE		2.2	135	85 - 91	912S	4	0,8	BPR7ES	2023	19	BPR8EIX
Exige 1.8 16V		1.8	132	07.00 -		4	0,8	BKR7E	6097		BKR8EIX

**MAHINDRA**

CJ 340 Classic D		2.1	48	93 -	XD 4.90	4		Y-208T	1250		
CJ 540 D		2.1	48	93 -	XD 4.90	4		Y-208T	1250		

**MASERATI**

2.24 V		2.0	180	88 -	AM 475	4	0,9	DCPR8E	4339		LPG 8
228 I		2.8	184	12.87 -	Bi Turbo Cat.	6	0,8	BP8ES	2912		BPR9EIX
3200 GT		3.2	271	12.98 - 09.01	585	8	0,7	PMR8A	5851		PMR8A
4.18 V		2.0		02.91 -		6	0,8	BP8ES	2912		BPR9EIX
4.24 V / Spider 24V		2.0	180	90 -	475	6	0,9	DCPR8E	4339		LPG 8
420 / I / S / SI /		2.0	138	01.87 -	470	6	0,8	BP8ES	2912		BPR9EIX
422		2.0	164	88 -	AM 471	6	0,8	BP8ES	2912		BPR9EIX
430		2.8	182	02.88 -	473 Cat.	6	0,8	BP8ES	2912		BPR9EIX
Coupè GT / Cambiocorsa		4.2	287	06.02 - 11.03	F136R	8	0,7	PMR8A	5851		PMR8A
Coupè GT / Cambiocorsa		4.2	287	12.03 -	F136R	8		PMR8B	6378		PMR9B
Ghibli		2.0	209	09.96 -	496	6	0,7	DCPR9E	2641		
Ghibli V6		2.8	209	11.95 -		6	0,8	DCPR9E	2641		
GranSport		4.2	294	09.04 -	F136S	8		PMR8B	6378		PMR9B
Karif		2.8	165	04.88 -	437 Cat.	6	0,8	BP8ES	2912		BPR9EIX
Quattroporte i. V6 24V		2.0	211	11.94 - 99	475	6	0,6	DCPR9E	2641		
Quattroporte i. V6 24V		2.8	209	11.95 - 01.99		6	0,8	DCPR9E	2641		
Quattroporte V6 Evoluzione		2.8	260	02.99 - 12.01	588	6	0,9	DCPR8E	4339		LPG 8
Quattroporte V8 Evoluzione		3.2	270	02.99 - 02	578	8	0,7	PMR8A	5851		PMR8A
Quattroporte 4,2		4.2	294	11.02 - 11.03		8	0,7	PMR8A	5851		PMR8A
Quattroporte 4,2		4.2	294	12.03 -	F136S	8		PMR8B	6378		PMR9B

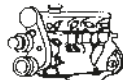
Code *l* kW

Cyl.



Stock-No.



LPG/CNG

**MASERATI**

Racing		2.0	194	02.91 -	475	6	0,7	DCPR9E	2641		
Shamal I Turbo 32V		3.2	240	02.91 - 02.96	AM 479 Cat.	8	0,9	DCPR8E	4339		LPG 8
Spyder		2.8	165	01.90 -	473 Cat.	6	0,8	BP8ES	2912		BPR9EIX
Spyder GT/Cambiocorsa		4.2	287	10.01 - 11.03	F136R	8	0,7	PMR8A	5851		PMR8A
Spyder GT/Cambiocorsa		4.2	287	12.03 -	F136R	8		PMR8B	6378		PMR9B

**MAYBACH**

Maybach 57/ 62	240	5.5	404	09.02 -	M 285.950	12	0,8	IFR6Q-G	5648		IFR6Q-G
Maybach 62S	240	6.0	450	09.05 -	M 285.980	12	0,8	IFR6Q-G	5648		IFR6Q-G

**MAZDA****121**

121 DA Fgst—> 200000		1.1	40	- 03.91	B1 u.Cat.	4	0,9	BPR5ES	7422	6	LPG 2
121 16V		1.25	55	00 - 02	DHB / DHC / DHD / DHF	4	1,3	PTR5A-13	2467	25	LPG 4
121 ZQ		1.3	37	03.96 -	JJA / JJC / JJE / J4C	4	1,0	PTR5D-10	3784	31	LPG 5
121 DB Fgst—> 400000		1.3	39	- 96	B3 16V Cat.	4	1,1	BKR6E-11	2756	14	LPG 1
121 DA Fgst 200001—>		1.3	40	- 96	B3 Cat.	4	1,1	BPR6ES-11	4824	13	LPG 2
121 DA Fgst—> 200000		1.3	44	03.96 -	B3	4	0,9	BPR5ES	7422	6	LPG 2
121 DB Fgst 400000—>		1.3	53	- 96	B3 16V Cat.	4	1,1	BKR6E-11	2756	14	LPG 1
121 ZQ		1.3	55	03.96 -	DHA Zetec (FORD)	4	1,3	PTR5A-13	2467	25	LPG 4
121		1.8	44	03.96 -	RTJ / RTK	4	█	Y-910R	4751	3	

**2**

2 DY Fgst 3*00001—>		1.25	55	03 - 07	MZI FUJA / F8JB	4	1,3	PTR5A-13	2467	25	LPG 4
2 DY Fgst 3*00001—>		1.25	55	03 - 07	MZI FUJB / F8JA	4	1,3	PTR5A-13	2467	25	LPG 4
2 1.3 (DE)		1.3	55	10.07 -	ZJ-VE / FUJA	4	1,3	IFR5E13	6903		
2 DY Fgst 3*00001—>		1.3	59	03 - 07	MZI DOHC FXJA / FXJB	4	1,3	PTR5A-13	2467	25	LPG 4
2 1.3 (DE)		1.3	63	10.07 -	ZJ-VEM / FXJA	4	1,3	IFR5E13	6903		
2 Di Turbo DY Fgst 3*00001—>		1.4	50	04.03 - 07	MZ-CD-SOHC F6JA	4	█	YE04	1684	40	
2 1.4 MZ-CD		1.4	50	07 -	F6JA	4	█	YE04	1684	40	
2 1.5 (DE)		1.5	76	10.07 -	ZY-VE / FYJA	4	1,3	IFR5E13	6903		
2 DY Fgst 3*00001—>		1.6	74	03 - 07	MZI DOHC FYJA	4	1,3	PTR5A-13	2467	25	LPG 4

**3**

3 1.4	BK	1.4	59	04 - 09	ZJ	4	1,1	BKR5E-11	6953	33	LPG 1
3 1.4	BK	1.4	62	10.03 - 03.06	ZJ07	4	1,1	BKR5E-11	6953	33	LPG 1
3 1.6	BK	1.6	77	10.03 -	CE	4	1,1	BKR5E-11	6953	33	LPG 1
3 1.6	BK	1.6	77	10.03 - 09	Z601 / Z627	4	1,1	BKR5E-11	6953	33	LPG 1
3 1.6 MZR	BL	1.6	77	06.09 -	Z668	4	1,3	IFR5E13	6903		IFR6E11
3 2.0 MZR-CD	BK	2.0	105	09.07 - 01.09	RF7J	4	█	Y-529J	4664		
3 2.0 Zündkerze am Fzg. ermitteln !	BK	2.0	110	10.03 - 01.04	LF17 / 50 / 72 / LFN7 / LFN8	4	1,3	ILTR5A-13G	3811		ILTR6A-13G
3 2.0 Zündkerze am Fzg. ermitteln !	BK	2.0	110	02.04 - 12.09	LF17 / 50 / 72 / LFN7 / LFN8	4	1,3	TR5AI-13	90813		LPG 5
3 2.0 MZR	BL	2.0	110	02.09 -	LF5H / LF5W / LFZ2	4	1,3	ILTR5A-13G	3811		ILTR6A-13G
3 2.0 MZR DISI	BL	2.0	111	02.09 -	LF5H / LF5W / LFZ2	4	1,3	ILTR5A-13G	3811		ILTR6A-13G
3 2.3 MPS Turbo	BL	2.3	191	05.09 -	L3Y7	4	0,7	SILTR6A7G	95369		
3 2.3 MPS	BK	2.3	191	06.06 - 01.09	L3M6	4	0,8	ILTR6A-8G	3787		

**323**

323 (BD1) Fgst 800000 —>		1.1	40		E1	4	0,8	BPR6ES	7822	2	LPG 2
323 (BF) Fgst—> 400000		1.1	40		E1	4	0,8	BPR6ES	7822	2	LPG 2
323 (BD1) Fgst 800000 —>		1.3	44		E3	4	0,8	BPR6ES	7822	2	LPG 2

Fgst = Chassis No.



Code *l* kW

Cyl.

Stock-No.  
**VEFINE**  
BY-PROMOTER

LPG/CNG

**MAZDA****323**

323 (BG)		1.3		90 -	B3 Vergaser	4	0,8	BKR5E	7938	35	LPG 1
323 (BF) Fgst 400001 →		1.4	44		B3 u.Cat.	4	0,8	BPR6ES	7822	2	LPG 2
323 (BG) Fgst → 500000		1.4	49		B3E Cat.	4	1,1	BPR6ES-11	4824	13	LPG 2
323 (BJ) Fgst 400001 →		1.4	53	02 -	B3 SOHC	4	1,1	BKR5E-11	6953	33	LPG 1
323 (BA) Fgst 500001 →		1.4	54		B3 16V Cat.	4	1,1	BKR6E-11	2756	14	LPG 1
323 (BG) Fgst 500001 →		1.4	54		B3 16V Cat.	4	1,1	BKR6E-11	2756	14	LPG 1
323 (BA) Fgst 300001 →		1.4	54	09.94 -	B3	4	1,1	BKR6E-11	2756	14	LPG 1
323 (BJ) Fgst 100001 →		1.4	54	09.98 -	B3	4	1,1	BKR5E-11	6953	33	LPG 1
323 (BF) Fgst 400001 →		1.5	54		B5 u.Cat.	4	0,8	BPR6ES	7822	2	LPG 2
323 (BW) Fgst 400001 → 500000		1.5	54		B5 u.Cat.	4	0,8	BPR6ES	7822	2	LPG 2
323 (BD1) Fgst 800000 →		1.5	55		E5	4	0,8	BPR6ES	7822	2	LPG 2
323 (BF) Fgst → 400000		1.5	55		E5	4	0,8	BPR6ES	7822	2	LPG 2
323 (BW) Fgst → 400000		1.5	55		E5	4	0,8	BPR6ES	7822	2	LPG 2
323 (BA) Fgst 500001 →		1.5	65		Z5 16V Cat.	4	1,1	BKR6E-11	2756	14	LPG 1
323 (BA) Fgst 100001 →		1.5	65	09.94 -	Z5 Cat.	4	1,1	BKR5E-11	6953	33	LPG 1
323 (BJ) Fgst 100001 →		1.5	65	09.98 -	ZL	4	1,1	BKR5E-11	6953	33	LPG 1
323 (BG) Fgst → 500000		1.6	62		B6E Cat.	4	1,1	BPR6ES-11	4824	13	LPG 2
323 (BF1) Fgst 400001 →		1.6	63		B6 Cat.	4	0,8	BPR6ES	7822	2	LPG 2
323 (BF1) Fgst → 400000		1.6	63		B6 Cat.	4	1,1	BPR5ES-11	4424		LPG 2
323 (BW) Fgst 500001 →		1.6	63		B6 Cat.	4	1,1	BPR6ES-11	4824	13	LPG 2
323 (BW) Fgst 400001 → 500000		1.6	63		B6 Cat.	4	1,1	BPR5ES-11	4424		LPG 2
323 (BG) Fgst 500001 →		1.6	65		B6 16V Cat.	4	1,1	BKR6E-11	2756	14	LPG 1
323 (BF1) Fgst → 400000		1.6	77		B6	4	0,8	BPR6ES	7822	2	LPG 2
323 Turbo BF2 400001 →		1.6	103		B6 DOHC Cat.	4	1,1	BCPR6E-11	3132	11	LPG 3
323 (BF1) Fgst 400001 →		1.6	103	85 - 91	B6 DOHC Cat.	4	1,1	BCPR6E-11	3132	11	LPG 3
323 (BF2) Fgst → 400000		1.6	110		B6 DOHC	4	0,8	BCPR6E	1269	12	LPG 3
323 TD BF → Fgst 300001		1.7	60	99 -	4EE1-T	4	█	CY03	6160	8	
323		1.7				4	█	CY03	6160	8	
323		1.8	84	02.97 -	B6D	4	1,1	BKR5E-11	6953	33	LPG 1
323 GTR Turbo		1.8	136	95 -		4	1,1	BKR6EVX-11	3540		LPG 1
323		1.8		89 -	BP DOHC Cat.	4	1,1	BKR6E-11	2756	14	LPG 1
323		1.8		89 -	BP EGI Cat.	4	0,8	BKR5E	7938	35	LPG 1
323 Turbo		1.8		89 -	BP	4	1,1	BKR6E-11	2756	14	LPG 1
323 (BG) Fgst 500001 →		1.9	76		BP SOHC 16V Cat.	4	1,1	BKR6E-11	2756	14	LPG 1
323 (BG) Fgst → 500000		1.9	76		BP SOHC 16V Cat.	4	1,1	BKR6E-11	2756	14	LPG 1
323 (BA) Fgst 500001 →		1.9	84		BP 16V Cat.	4	1,1	BKR6E-11	2756	14	LPG 1
323 (BA) Fgst 300001 →		1.9	84	09.94 -	BP 16V Cat.	4	1,1	BKR5E-11	6953	33	LPG 1
323 (BJ) Fgst 100001 →		1.9	84	09.98 -	FP	4	1,1	BKR5E-11	6953	33	LPG 1
323 (BG) Fgst 500001 →		1.9	94		BP DOHC 16V Cat.	4	1,1	BKR6E-11	2756	14	LPG 1
323 (BG) Fgst → 500000		1.9	94		BP DOHC 16V Cat.	4	1,1	BKR6E-11	2756	14	LPG 1
323 (BG) Turbo 16V		1.9	120		BP DOHC 16V Cat.	4	1,1	BKR6E-11	2756	14	LPG 1
323 (BJ) Fgst 400001 →		2.0	96	02 - 04	FS7G / FS7E	4	1,1	ZFR5F-11	2262		LPG 6
					DOHC (High Power)						
323 F (BJ)		2.0	100	10.00 - 10.03	RF4F	4	█	Y-529J	4664		
323 (BA) Fgst 100001 →		2.0	106	09.94 - 10.98	KF DOHC V6	6	1,1	BKR6E-11	2756	14	LPG 1
323 (BA) Fgst 500001 →		2.0	106	08.94 - 10.98	KF DOHC V6	6	1,1	BKR6E-11	2756	14	LPG 1

**5**

5 1.8	CR19	1.8	85	06.05 -	L8	4	1,3	TR5AI-13	90813		LPG 5
5 2.0 CD	CR19	2.0	81	02.05 - 05.10	RF7J	4	█	Y-529J	4664		
5 2.0 CD	CR19	2.0	105	02.05 - 05.10	RF7J	4	█	Y-529J	4664		

Fgst = Chassis No.

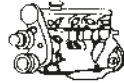
Code *l* kW

Cyl.

Stock-No.  
**VLIVE**  
10-14700000000000000000

LPG/CNG

**MAZDA****5**

5 2.0	CR19	2.0	107	06.05 -	LFF7	4	1,3	TR5AI-13	90813	LPG 5
5 2.3	CR19	2.3		05 -	L3-VE	4	1,3	TR5AI-13	90813	LPG 5
5 2.0 Zündkerze am Fzg. ermitteln !	CW19	2.0	106	06.10 -	LFZB	4	1,3	TR5AI-13	90813	LPG 5
5 2.0 Zündkerze am Fzg. ermitteln !	CW19	2.0	106	06.10 -	LFZB	4	1,3	ILTR6A-13G	3789	ILTR6A-13G
5 2.0 Zündkerze am Fzg. ermitteln !	CW19	2.0	110	06.10 -	LF5H	4	1,3	TR5AI-13	90813	LPG 5
5 2.0 Zündkerze am Fzg. ermitteln !	CW19	2.0	110	06.10 -	LF5H	4	1,3	ILTR6A-13G	3789	ILTR6A-13G

**6**

6 1.8 Fgst 100001—>	GG	1.8	88	06.02 - 07	MZR-L8 DOHC	4	1,3	ITR6F13	4477	LPG 5
6 1.8 Sport-Kombi Fgst 100001—>	GY	1.8	88	06.02 - 07	MZR-L8 DOHC	4	1,3	ITR6F13	4477	LPG 5
6 1.8		1.8	88	09.07 -	L823	4	1,3	TR5AI-13	90813	LPG 5
6 2.0 DI	GG	2.0	89	10.02 - 09.07	RF5C	4	█	Y-529J	4664	
6 2.0 DI	GG	2.0	100	10.02 - 09.07	RF5C	4	█	Y-529J	4664	
6 2.0 Zündkerze am Fzg. ermitteln !	GG	2.0	104	06.02 - 09.07	LF17 / LF18	4	1,3	ITR6F13	4477	LPG 5
6 2.0 Zündkerze am Fzg. ermitteln !	GG	2.0	104	06.02 - 09.07	LF17 / LF18	4	1,3	ILTR5A-13G	3811	ILTR6A-13G
6 2.0 Sport-Kombi Fgst 100001—>	GY	2.0	104	06.02 - 02.05	LF17 / LF18	4	1,3	ILTR5A-13G	3811	ILTR6A-13G
6 2.0 DI	GG	2.0	105	03.05 - 09.05	RF7J	4	█	Y-529J	4664	
6 2.0 Zündkerze am Fzg. ermitteln !	GG	2.0	108	03.05 - 09.07	LFH1 / LFF7	4	1,3	ITR6F13	4477	LPG 5
6 2.0 Zündkerze am Fzg. ermitteln !	GG	2.0	108	03.05 - 09.07	LFH1 / LFF7	4	1,3	ILTR5A-13G	3811	ILTR6A-13G
6 2.0 Sport-Kombi	GY	2.0	108	03.05 - 01.08	LFH1 / LFF7	4	1,3	ILTR5A-13G	3811	ILTR6A-13G
6 2.0	GH	2.0	108	08.07 -	L17 / LF95	4	1,3	ILTR5A-13G	3811	ILTR6A-13G
6 2.0		2.0		06.05 -	LF-VE	4	1,3	ILTR5A-13G	3811	ILTR6A-13G
6 2.3 Sport-Kombi 4WD Fgst 100001—>	GY	2.3	119	06.02 - 07	MZR-L3 DOHC	4	1,3	ITR6F13	4477	LPG 5
6 2.3 Fgst 100001—>	GG	2.3	122	06.02 - 07	MZR-L3 DOHC	4	1,3	ITR6F13	4477	LPG 5
6 2.3 Sport-Kombi Fgst 100001—>	GY	2.3	122	06.02 - 07	MZR-L3 DOHC	4	1,3	ITR6F13	4477	LPG 5
6 2.3		2.3	122	06.05 -	L3C1	4	1,3	ILTR5A-13G	3811	ILTR6A-13G

**626**

626 (GF) Fgst 100001—>		1.8	66	07.97 -	FP DOHC	4	0,8	PZFR6F	7550	LPG 6
626 (GF) Fgst.100001 —>		1.9	66		FP DOHC	4	0,8	PZFR6F	7550	LPG 6
626 (GW) Fgst 100001 —>		1.9	66		FP DOHC 16V	4	0,8	PZFR6F	7550	LPG 6
626 (GE) Fgst 434202 —>		1.9	66	09.94 -	FP DOHC	4	1,1	BKR6E-11	2756	14 LPG 1
626 (GF)		1.9	66	07.97 -	FP	4	0,8	PZFR6F	7550	LPG 6
626 (GF) Fgst 400001—>		1.9	74	00 -	FP DOHC	4	0,8	PZFR6F	7550	LPG 6
626 (GW) Fgst 208843—>		1.9	74	00 -	FP DOHC	4	0,8	PZFR6F	7550	LPG 6
626 (GE) Fgst 100001 —>		1.9	77	92 -	FP DOHC Cat.	4	1,1	BKR6E-11	2756	14 LPG 1
626 (GD) Fgst 500001—>		2.0	66		FE Cat.	4	0,8	BPR6ES	7822	2 LPG 2
626 (GD) Fgst—> 500000		2.0	66		FE Cat.	4	1,1	BPR6ES-11	4824	13 LPG 2
626 (GD) Fgst—> 500000		2.0	66		FE Cat.	4	0,8	BPR6ES	7822	2 LPG 2
626 (GV) Fgst 200001 —>		2.0	66		FE Cat.	4	0,8	BPR6ES	7822	2 LPG 2
626 (GV) Fgst—> 200000		2.0	66		FE Cat.	4	0,8	BPR6ES	7822	2 LPG 2
626 (GF) 2.0 DITD		2.0	66	04.98 - 10.02	RF3F	4	█	Y-529J	4664	
626 (GC) Fgst 700001—>		2.0	68		FE Cat.	4	0,8	BPR6ES	7822	2 LPG 2
626 (GC) Fgst—> 700000		2.0	74		FE	4	0,8	BPR6ES	7822	2 LPG 2
626 (GF) 2.0 Turbo DI		2.0	74	04.98 - 10.02	RF2A	4	█	Y-529J	4664	
626 DIDT GF Fgst 186527—>		2.0	74	09.98 -	RF	4	█	Y-529J	4664	
626 DIDT Kombi GF Fgst 116329—>		2.0	74	09.98 -	RF	4	█	Y-529J	4664	
626 (GD) Fgst—> 500000		2.0	79		FE 12 Valve	4	0,8	BCPR6E	1269	12 LPG 3
626 (GF) 2.0 TD		2.0	81	10.00 - 10.02	RF4F	4	█	Y-529J	4664	
626 (GF) Fgst 100001—>		2.0	85		FS DOHC	4	0,8	PZFR6F	7550	LPG 6
626 (GW) Fgst 100001 —>		2.0	85		FS DOHC 16V	4	0,8	PZFR6F	7550	LPG 6

Fgst = Chassis No.

Code *l* kW

Cyl.

Stock-No.  
**VENICE**  
BY-PROMOTER

LPG/CNG

**MAZDA****626**

626(USA)GE Fgst 803719—>		2.0	85		FS DOHC	4	1,1	BKR5E-11	6953	33	LPG 1
626(USA)GE Fgst 802219—>		2.0	85	92 - 98	FS DOHC	4	1,1	BKR5E-11	6953	33	LPG 1
626 (GE) Fgst 4343202—>		2.0	85	94 -	FS DOHC Cat.	4	1,1	BKR6E-11	2756	14	LPG 1
626 (GF) Fgst 400001—>		2.0	85	00 -	FS DOHC	4	0,8	PZFR6F	7550		LPG 6
626 (GW) Fgst 200001—>		2.0	85	00 -	FS DOHC	4	0,8	PZFR6F	7550		LPG 6
626 (GC) Fgst 700001—>		2.0	88		FE	4	0,8	BPR6ES	7822	2	LPG 2
626 (GF) Fgst.100001 —>		2.0	100		FS DOHC	4	0,8	PZFR6F	7550		LPG 6
626 (GW) Fgst 100001 —>		2.0	100		FS DOHC 16V	4	0,8	PZFR6F	7550		LPG 6
626 (GF)		2.0	100	07.97 -	FS	4	0,8	PZFR6F	7550		LPG 6
626 (GF) Fgst 400001—>		2.0	100	00 -	FS DOHC High Power	4	0,8	PZFR6F	7550		LPG 6
626 (GW) Fgst 208843—>		2.0	100	00 -	FS DOHC High Power	4	0,8	PZFR6F	7550		LPG 6
626 (GD) Fgst 500001—>		2.0	103		FE 16V Cat.	4	1,1	BKR6E-11	2756	14	LPG 1
626 (GD) Fgst—> 500000		2.0	103		FE 16V Cat.	4	1,1	BCPR6E-11	3132	11	LPG 3
626 (GD) Fgst 500001—>		2.2	85		F2 12 Valve Cat.	4	1,1	ZFR6F-11	4291		LPG 6
626 (GD) Fgst—> 500000		2.2	85		F2 12 Valve Cat.	4	1,1	ZFR6A-11	1041		
626 (GV) Fgst 200001—>		2.2	85		F2 12 Valve Cat.	4	1,1	ZFR6F-11	4291		LPG 6
626 (GV) Fgst—> 200000		2.2	85		F2	4	1,1	ZFR6A-11	1041		
626 (GE) Fgst 434202 —>		2.5	120	09.94 -	KL DOHC V6	6	1,1	ZFR5F-11	2262		LPG 6
626 (GE) Fgst 100001—>		2.5	121	92 - 94	KL DOHC V6 Cat.	6	1,1	ZFR6F-11	4291		LPG 6

**B SERIE**

B 1600		1.6				4	0,9	BPR5ES	7422	6	LPG 2
B 1800		1.8				4	0,9	BPR5ES	7422	6	LPG 2
B 2000		2.0				4	0,9	BPR5ES	7422	6	LPG 2
B 2200		2.2			S 2	4	█	Y-107T	1253		
B 2200		2.2		01.85 - 10.96	R 2	4	█	Y-107R	1229		
B 2200		2.2		90 -	F2	4	0,9	BPR5ES	7422	6	LPG 2
B 2200		2.2		90 -	F2 EGI	4	1,1	BPR5ES-11	4424		LPG 2
B 2500 UF Fgst 702487—>		2.5	57	99 -	WL	4	█	Y-701J	1566	39	
B 2600		2.6		90 -	G6	6	1,1	ZFR5F-11	2262		LPG 6
B Serie				97 - 11.02	WLT		█	Y-701J	1566	39	

**BT-50**

BT-50 2.5 MRZ-CD (CD)		2.5	105	08.06 -	WLAA	4	█	Y-526J1	93283	69	
BT-50 3.0 CDVi (CD)		3.0	115	10.06 -	WEAT	4	█	Y-526J1	93283	69	

**CX-7**

CX-7 2.3 MZR DISI Turbo	ER8	2.3	190	10.07 - 05.09	L3K4 / L3-VDT	4	0,8	ILTR6A-8G	3787		
CX-7 2.3 MZR DISI Turbo	ER8	2.3	190	06.09 - 08.09	L3K4 / L3-VDT	4	0,7	SILTR6A7G	95369		
CX-7 2.3 MZR DISI Turbo	ER9	2.3	191	09.09 -	L3ZA	4	0,7	SILTR6A7G	95369		

**DEMIO**

Demio DW Fgst 100.001 —>		1.4	46	98 - 03	B3 SOHC	4	1,1	BKR6E-11	2756	14	LPG 1
Demio DW Fgst 300001—>		1.4	46	00 - 03	B3 SOHC	4	1,1	BKR5E-11	6953	33	LPG 1
Demio DW Fgst 100.001 —>		1.4	53	98 - 03	B3 (High Power)	4	1,1	BKR6E-11	2756	14	LPG 1
Demio DW Fgst 300001—>		1.5	55	05.00 - 03	B5 SOHC	4	1,1	BKR6E-11	2756	14	LPG 1

**E SERIE**

E 2000 SR Fgst 600001—>		2.0	60		FE	4	0,9	BPR5ES	7422	6	LPG 2
E 2000 SR Fgst—> 600000		2.0	63	84 - 95	FE	4	0,8	BPR6ES	7822	2	LPG 2
E 2000 SR Fgst 800001—>		2.0	70		FE 8V	4	1,1	BKR5E-11	6953	33	LPG 1
E 2000 SR Fgst 700001—>		2.0	70	95 -	FE	4	1,1	BKR6E-11	2756	14	LPG 1
E 2000 SR Fgst X100001—>		2.0	70	99 -	FE	4	1,1	BKR5E-11	6953	33	LPG 1

Fgst = Chassis No.

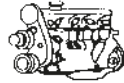
Code *ℓ* kW

Cyl.



Stock-No.



LPG/CNG

**MAZDA  
E SERIE**

E 2000		2.0		93 -	RF	4		Y-107R	1229		
E 2200		2.2		02.83 - 92	F2	4		Y-107R	1229		
E 2200		2.2		93 - 96	R2	4		Y-107R	1229		
E 3000		3.0		93 -	L4DE			Y-721RS	3687		
E 3000		3.0		93 -	VS			Y-721RS	3687		
E Serie				97 -	R2			Y-721RS	3687		

**MPV**

MPV LW Fgst Y100001→		2.0	90	06.99 - 04.02	FS DOHC	4	1,1	ZFR5F-11	2262		LPG 6
MPV		2.0	100	97 - 06.02	WLT	4		Y-701J	1566	39	
MPV LW Fgst 200001→		2.3	104	05.02 -	MZR-L3 DOHC	4	1,3	ITR6F13	4477		LPG 5
MPV		2.5		02 -	AJ	6	1,0	TR5IX	7397		LPG 5
MPV LV Fgst 100001→		3.0	109	05.96 -	JE 12V	6	1,1	BKR6E-11	2756	14	LPG 1
MPV LV 52 Fgst 631983→		3.0	113	09.94 -	JEE	6	1,1	ZFR6F-11	4291		LPG 6

**MX-3**

MX-3 EC		1.6	65	08.91 -	B6 SOHC Cat.	4	1,1	BKR5E-11	6953	33	LPG 1
MX-3 EC Fgst 208015→		1.6	79	94 -	B6 DOHC	4	1,1	BKR6E-11	2756	14	LPG 1
MX-3 EC Fgst 208015→		1.8	95	95 -	K8 DOHC	6	1,1	BKR5E-11	6953	33	LPG 1
MX-3 EC		1.8	98	08.91 -	K8 DOHC Cat.	6	1,1	BKR5E-11	6953	33	LPG 1

**MX-5**

MX-5 NA Fgst 308212→		1.6	66		B6 DOHC	4	1,1	BKR6E-11	2756	14	LPG 1
MX-5 NA Fgst 200001→		1.6	66	95 -	B6 DOHC	4	1,1	BKR6E-11	2756	14	LPG 1
MX-5 NB Fgst 100001→		1.6	81	98 -	B6 DOHC	4	1,1	BKR5E-11	6953	33	LPG 1
MX-5 NA Fgst 100001→		1.6	85	90 -	B6 DOHC Cat.	4	1,1	BKR6E-11	2756	14	LPG 1
MX-5		1.8	93	06 -		4	1,3	TR5AI-13	90813		LPG 5
MX-5 NA Fgst 308212→		1.9	96		BP DOHC	4	1,1	BKR6E-11	2756	14	LPG 1
MX-5 NA Fgst 100000→		1.9	96	94 -	BP DOHC Cat.	4	1,1	BKR6E-11	2756	14	LPG 1
MX-5 NB Fgst 300001→ Automatic		1.9	102	01 -	BP DOHC	4	1,1	BKR5E-11	6953	33	LPG 1
MX-5 NB Fgst 100001→		1.9	103	98 -	BP DOHC	4	1,1	BKR5E-11	6953	33	LPG 1
MX-5 NB Fgst 121912→ (Anniversary)		1.9	103	00 -	BP DOHC	4	1,1	BKR5E-11	6953	33	LPG 1
MX-5 NB Fgst 200001→		1.9	107	01 -	BP DOHC	4	1,1	BKR5E-11	6953	33	LPG 1
MX-5		2.0	118	01.06 -	LF-VE	4	1,3	ILTR6A-13G	3789		ILTR6A-13G

**MX-6**

MX-6 GE Fgst 100001→		2.0	85	92 -	FS DOHC Cat.	4	1,1	BKR6E-11	2756	14	LPG 1
MX-6 GE Fgst 400001→		2.0	85	09.94 -	FS DOHC	4	1,1	BKR5E-11	6953	33	LPG 1
MX-6		2.2		92 -	F2	4	1,1	ZFR6F-11	4291		LPG 6
MX-6 GE Fgst 400001→		2.5	120	09.94 -	KL DOHC V6	6	1,1	ZFR5F-11	2262		LPG 6
MX-6 GE Fgst 100001→		2.5	121	92 -	KL DOHC V6 Cat.	6	1,1	ZFR5F-11	2262		LPG 6

**PREMACY**

Premacy 1.9 Fgst 100001→151176	CP	1.9	74		FP DOHC	4	1,1	BKR5E-11	6953	33	LPG 1
Premacy 1.9 Fgst 151177→	CP	1.9	74	06.99 -	FP DOHC	4	1,1	ZFR5F-11	2262		LPG 6
Premacy 1.9 Fgst 151177→	CP	1.9	85	06.99 -	FP DOHC with VICS	4	1,1	ZFR5F-11	2262		LPG 6
Premacy 2.0 TD	CP	2.0	66	03.99 - 03.00	RF3F	4		Y-529J	4664		
Premacy 2.0 TD	CP	2.0	74	07.00 - 06.05	RF4F	4		Y-529J	4664		
Premacy 2.0 Fgst 300001→	CP	2.0	96		FS DOHC	4	1,1	BKR5E-11	6953	33	LPG 1

**RANGER**

Ranger					S 2			Y-107T	1253		
--------	--	--	--	--	-----	--	--	--------	------	--	--

Fgst = Chassis No.

Code *l* kW

Cyl.



Stock-No.

LPG/CNG

**MAZDA****RX-7**

RX-7 FB Fgst 700001—>			83		12 A			BR8ET	4221		BR9EIX
RX-7 FC Fgst—> 200000			110		13 B			BR10ET	7480		BR10EIX
RX-7 Turbo FC Fgst—>200000			133		RE 13 B		1,0	SD11A	1199		
RX-7 Turbo FC Fgst 200001—>			147	90 -	RE 13 B			BUR9EQ	5483		
RX-7 Turbo FD Fgst—>100000			176		13B-REV			BUR9EQP	5255		

**RX-8**

RX-8		2.6	141	09.03 - 12.10	13B-MSP 2+2sparkplug			RE8C-L + RE9B-T	5745 +2809		
RX-8 Sport		2.6	170	09.03 - 12.10	13B-MSP(high power) 2+2sparkplug			RE8C-L + RE9B-T	5745 +2809		

**T SERIE**

T 3000		3.0		93 -	HA		<input checked="" type="checkbox"/>	Y-771R	4262		
T 3000		3.0		93 -	L4DE		<input checked="" type="checkbox"/>	Y-771R	4262		
T Serie				97 -	VS		<input checked="" type="checkbox"/>	Y-771R	4262		

**TRIBUTE**

Tribute EP Fgst M00001—>		2.0	91	04.00 -	Zetec 16V	4	1,3	PTR5A-13	2467	25	LPG 4
Tribute EP2 Fgst M00001—>		2.0	91	04.00 -	Zetec 16V	4	1,3	PTR5A-13	2467	25	LPG 4
Tribute		2.0		03 -	Ford	4	1,3	PTR5A-13	2467	25	LPG 4
Tribute		2.3	110	03 -	MZR-L3 DOHC	4	1,3	ITR6F13	4477		LPG 5
Tribute V6 EP Fgst M00001—>		3.0	145	04.00 -	Duratec 24V	6	1,0	TR5IX	7397		LPG 5
Tribute V6 EP2 Fgst M00001—>		3.0	145	04.00 -	Duratec 24V	6	1,0	TR5IX	7397		LPG 5

**XEDOS 6**

Xedos 6 CA Fgst 210758—>		1.6	79	09.94 -	B6 DOHC	4	1,1	BKR5E-11	6953	33	LPG 1
Xedos 6 CA Fgst 210758—>		2.0	103	09.94 -	KF DOHC V6	6	1,1	BKR6E-11	2756	14	LPG 1
Xedos 6 CA Fgst 100001—>		2.0	106	06.92 -		4	1,1	BKR6E-11	2756	14	LPG 1

**XEDOS 9**

Xedos 9 TA Fgst 200001—>		2.0	105	10.93 -	KF V6 DOHC	6	1,1	BKR6E-11	2756	14	LPG 1
Xedos 9 TA Fgst 200001—>		2.3	155	02.95 -	KJ V6 DOHC Miller Mot	6	0,8	PZFR5F	3741		LPG 6
Xedos 9 TA Fgst 400001—>		2.5	120		KL-V6 DOHC	6	1,1	ZFR5F-11	2262		LPG 6
Xedos 9 TA V6		2.5	120	01 -	KJD	6	1,1	BKR5E-11	6953	33	LPG 1
Xedos 9 TA Fgst 200001—>		2.5	128	10.93 -	KL-ZE V6	6	1,1	ZFR5F-11	2262		LPG 6

**MERCEDES****190 W201**

190 E 1.8	201	1.8	80	05.90 - 05.93	M 102.910	4	0,8	BP6EFS	3812	5	LPG 5
190 D	201	2.0	53	02.89 - 05.93	OM 601.911	4	<input checked="" type="checkbox"/>	Y-916J	5906	6	
190 E	201	2.0	87	09.85 - 08.93	M 102.962	4	0,8	BP6EFS	3812	5	LPG 5
190 E 2.3	201	2.3	97	09.86 - 05.93	M 102.985	4	0,8	BP6EFS	3812	5	LPG 5
190 D	201	2.5	66	02.89 - 05.93	OM 602.911	5	<input checked="" type="checkbox"/>	Y-916J	5906	6	
190 Turbo-D 2.5	201	2.5	90	02.89 - 05.93	OM 602.961	5	<input checked="" type="checkbox"/>	Y-916J	5906	6	
190 Turbo-D 2.5	201	2.5	90	02.89 - 05.93	OM 602.961	5	<input checked="" type="checkbox"/>	Y-918J	6285	2	
190 E 2.5 16V	201	2.5	143	09.88 - 05.93	M 102.990	4	0,8	BP6EFS	3812	5	LPG 5
190 E Evolution II 2.5 16V	201	2.5	173	05.90 - 05.93	M 102.992	4	0,8	BP6EFS	3812	5	LPG 5
190 E 2.6	201	2.6	118	09.86 - 05.93	M 103.942	6	0,8	BP6EFS	3812	5	LPG 5

**A W168**

A 140	168	1.4	60	10.97 - 08.04	M 166.940	4		BKUR5ET	2789	29	LPG 1
A 140	168	1.6	60	01.01 - 08.04	M 166.960	4		BKUR5ET	2789	29	LPG 1
A 160	168	1.6	75	10.97 - 08.04	M 166.960	4		BKUR5ET	2789	29	LPG 1

Fgst = Chassis No.

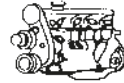

Code *l* kW

Cyl.



Stock-No.



LPG/CNG

**MERCEDES****A W168**

A 160 CDI	168	1.7	44	10.97 - 02.01	OM 668.941	4		Y-746R	4842	38	
A 160 CDI	168	1.7	55	02.01 - 08.04	OM 668.940	4		Y-746R	4842	38	
A 170 CDI	168	1.7	66	08.98 - 02.01	OM 668.940	4		Y-746R	4842	38	
A 170 CDI	168	1.7	70	02.01 - 08.04	OM 668.942	4		Y-746R	4842	38	
A 190	168	1.9	92	03.99 - 08.04	M 166.990	4		BKUR5ET	2789	29	LPG 1
A 210 Evolution	168	2.0	103	03.02 - 08.04	M 166.995	4		BKUR5ET	2789	29	LPG 1

**A W169**

A 150	169	1.5	70	09.04 -	M 266.920	4	0,9	BKR6EZB	4293		
A 170	169	1.7	85	09.04 -	M 266.940	4	0,9	BKR6EZB	4293		
A 160 CDI	169	2.0	60	09.04 -	OM 640.942	4		Y8002AS	6287	51	
A 180 CDI	169	2.0	80	09.04 -	OM 640.940	4		Y8002AS	6287	51	
A 200	169	2.0	100	09.04 -	M 266.960	4	0,9	BKR6EZB	4293		
A 200 Turbo	169	2.0	142	09.05 -	M 266.980	4	1,0	IFR6D10	5344		LPG 1
A 200 CDI	169	2.0	103	09.04 -	OM 640.941	4		Y8002AS	6287	51	

**A W176**

A 180 CDi	176	1.8	80	06.12 -	OM 651.901	4		CZ303	7865	54	
A 200 CDi	176	1.8	100	06.12 -	OM 651.901	4		CZ303	7865	54	
A 220 CDi	176	2.2	125	06.12 -	OM 651.930	4		CZ303	7865	54	

**B W245**

B 150	245	1.5	70	04.05 - 11	M 266.920	4	0,9	BKR6EZB	4293		
B 170	245	1.7	85	04.05 - 11	M 266.940	4	0,9	BKR6EZB	4293		
B 180 Cdi	245	2.0	80	04.05 - 10.07	OM 640.940	4		Y8002AS	6287	51	
B 180 Cdi	245	2.0	80	11.07 - 11	OM 640.940	4		CZ303	7865	54	
B 180 NGT	245	2.0	85	04.08 -	M 266.960	4	0,9	BKR6EZB	4293		
B 200	245	2.0	100	04.05 - 11	M 266.960	4	0,9	BKR6EZB	4293		
B 200 Cdi	245	2.0	100	04.05 - 11.07	OM 640.941	4		Y8002AS	6287	51	
B 200 Cdi	245	2.0	100	12.07 - 11	OM 640.941	4		CZ303	7865	54	
B 200 Cdi	245	2.0	103	04.05 - 11.07	OM 640.941	4		Y8002AS	6287	51	
B 200 Cdi	245	2.0	103	12.07 - 11	OM 640.941	4		CZ303	7865	54	
B 200 Turbo	245	2.0	142	04.05 - 11	M 266.980	4	1,0	IFR6D10	5344		LPG 1

**B W246**

B 180 CDI	246	1.8	80	11.11 -	OM 651.901	4		CZ303	7865	54	
B 200 CDI	246	1.8	100	11.11 -	OM 651.901	4		CZ303	7865	54	

**C W/S 202**

C 180	202	1.8	90	06.93 - 06.97	M 111.920	4	0,7	BCP6ES	4930	17	LPG 3
C 180	202	1.8	90	07.97 - 05.00	M 111.921	4		BKUR5ET	2789	29	LPG 1
C 180	202	1.8	95	09.00 - 03.01	M 111.952	4	1,0	IFR6D10	5344		LPG 1
C 200 D	202	2.0	55	07.93 - 05.00	OM 601.913	4		Y-916J	5906	6	
C 200 D	202	2.0	65	10.96 - 05.00	OM 604.915	4		Y-925J	6848	16	
C 200	202	2.0	100	03.94 - 06.97	M 111.941	4	0,7	BCP6ES	4930	17	LPG 3
C 200	202	2.0	100	07.97 - 05.00	M 111.945	4		BKUR5ET	2789	29	LPG 1
C 200	202	2.0	120	09.00 - 03.01	M 111.956	4	1,0	IFR6D10	5344		LPG 1
C 200 Kompressor	202	2.0	132	09.95 - 10.96	M 111.944	4		BKUR6ET-10	2397	24	LPG 1
C 200 Kompressor	202	2.0	141	11.96 - 05.00	M 111.944	4		BKUR6ET-10	2397	24	LPG 1
C 220 D	202	2.2	70	07.93 - 05.95	OM 604.910	4		◆ Y-930U §	4275	30	
C 220 D	202	2.2	70	06.95 - 05.00	OM 604.910	4		Y-925J	6848	16	
C 200 CDI	202	2.2	75	03.98 - 05.00	OM 611.960	4		Y-745U	6346	11	
C 220 CDI	202	2.2	75	06.98 - 05.00	OM 611.961	4		Y-745U	6346	11	
C 220 CDI	202	2.2	92	09.97 - 03.01	OM 611.960	4		Y-745U	6346	11	

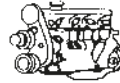

Code *l* kW

Cyl.

Stock-No.  
**VEINE**  
BY-PROMOTER

LPG/CNG

**MERCEDES****C W/S 202**

C 220	202	2.2	110	06.93 - 09.96	M 111.961	4	0,7	BCP6ES	4930	17	LPG 3
C 230	202	2.3	110	09.96 - 05.97	M 111.974	4	0,7	BCP6ES	4930	17	LPG 3
C 230 Kompressor	202	2.3	142	10.95 - 05.00	M 111.975	4		BKUR6ET-10	2397	24	LPG 1
C 240 V6	202	2.4	125	04.97 - 05.00	M 112.910 Twin Spark	6	1,1	PFR5R-11	4292		LPG 1
C 240 V6	202	2.6	125	09.00 - 03.01	M 112.915 Twin Spark	6	1,1	PFR5R-11	4292		LPG 1
C 250 D	202	2.5	83	07.93 - 01.95	OM 605.910	5		◆ Y-930U §	4275	30	
C 250 D	202	2.5	83	02.95 - 08.95	OM 605.910	5		Y-925J	6848	16	
C 250 Turbo-D	202	2.5	110	05.96 - 05.00	OM 605.960	5		Y-925J	6848	16	
C 280	202	2.8	141	06.93 - 05.97	M 104.941	6	0,7	BCP6ES	4930	17	LPG 3
C 280 V6	202	2.8	145	06.97 - 05.00	M 112.920 Twin Spark	6	1,1	PFR5R-11	4292		LPG 1
C 36 AMG	202	3.6	206	01.94 - 05.97	M 104.941	6		BKR5EKU	3964		
C 43 AMG	202	4.3	225	09.97 - 05.00	M 113.944 Twin Spark	8	1,1	PFR5R-11	4292		LPG 1

**C W/S 203**

C 180	203	2.0	95	05.00 - 05.02	M 111.951	4	1,0	IFR6D10	5344		LPG 1
C 180 Kompressor	203	1.8	105	05.02 - 11.06	M 271.940 -> 30853899	4	0,8	ILFR6A	3588		ILFR6A
C 180 Kompressor	203	1.8	105	12.06 -	M 271.940 30853900 ->	4	0,8	PLKR7B8E	94716		PLKR7B8E
C 180 Kompressor	203	1.8	105	05.02 - 11.06	M 271.946 -> 30853899	4	0,8	ILFR6A	3588		ILFR6A
C 180 Kompressor	203	1.8	105	12.06 -	M 271.946 30853900 ->	4	0,8	PLKR7B8E	94716		PLKR7B8E
C 200 CDI	203	2.2	75	03.01 - 03.03	OM 646.962	4		Y-745U	6346	11	
C 200 CDI	203	2.2	85	05.00 - 03.04	OM 611.962	4		Y-745U	6346	11	
C 200 CDI	203	2.2	90	04.03 - 03.07	OM 646.962	4		Y-745U	6346	11	
C 200 CGI Kompressor	203	1.8	125	02.03 - 11.06	M 271.942 -> 30853899	4	0,8	ILFR6A	3588		ILFR6A
C 200 CGI Kompressor	203	1.8	125	12.06 -	M 271.942 30853900 ->	4	0,8	PLKR7B8E	94716		PLKR7B8E
C 200 Kompressor	203	1.8	105	02.03 - 11.06	M 271.942 -> 30853899	4	0,8	ILFR6A	3588		ILFR6A
C 200 Kompressor	203	1.8	105	12.06 -	M 271.942 30853900 ->	4	0,8	PLKR7B8E	94716		PLKR7B8E
C 200 Kompressor	203	1.8	120	02.03 - 11.06	M 271.940 -> 30853899	4	0,8	ILFR6A	3588		ILFR6A
C 200 Kompressor	203	1.8	120	12.06 -	M 271.940 30853900 ->	4	0,8	PLKR7B8E	94716		PLKR7B8E
C 200 Kompressor	203	1.8	135	12.06 -	M 271.957 30853900 ->	4	0,8	PLKR7B8E	94716		PLKR7B8E
C 200 Kompressor	203	2.0	120	05.00 -	M 111.955	4	1,0	IFR6D10	5344		LPG 1
C 220 CDI	203	2.2	105	05.00 - 12.04	OM 611.962	4		Y-745U	6346	11	
C 220 CDI	203	2.2	110	04.03 - 10.07	OM 646.963	4		Y-745U	6346	11	
C 230	203	2.5	150	12.04 -	M 272.920	6	0,8	PLKR7A	4288		PLKR7A
C 230 Kompressor	203	2.3	145	03.01 - 05.02	M 111.981	4	1,0	IFR6D10	5344		LPG 1
C 230 Kompressor	203	1.8	141	02.04 - 11.06	M 271.948 -> 30853899	4	0,8	ILFR6A	3588		ILFR6A
C 230 Kompressor	203	1.8	141	12.06 -	M 271.948 30853900 ->	4	0,8	PLKR7B8E	94716		PLKR7B8E
C 240	203	2.6	125	05.00 -	M 112.912 Twin Spark	6	1,1	PFR5R-11	4292		LPG 1
C 240 4-Matic	203	2.6	125	07.02 -	M 112.916 Twin Spark	6	1,1	PFR5R-11	4292		LPG 1

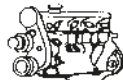

Code *l* kW

Cyl.



Stock-No.



LPG/CNG

**MERCEDES  
C W/S 203**

C 270 CDI	203	2.7	125	12.00 - 12.04	OM 612.962	5		Y-745U	6346	11	
C 280	203	3.0	170	11.04 -	M 272.940	6	0,8	PLKR7A	4288		PLKR7A
C 280 4-Matic	203	3.0	170	02.05 -	M 272.941	6	0,8	PLKR7A	4288		PLKR7A
C 32 AMG Kompressor	203	3.2	260	00 -	M 112.961 Twin Spark	6	1,0	IFR6D10	5344		LPG 1
C 320	203	3.2	160	05.00 -	M 112.946 Twin Spark	6	1,1	PFR5R-11	4292		LPG 1
C 320 4-Matic	203	3.2	160	07.02 -	M 112.953 Twin Spark	6	1,1	PFR5R-11	4292		LPG 1
C 320 CDI	203	3.0	165	12.04 - 11.07	OM 642.910	6		Y8002AS	6287	51	
C 350	203	3.5	200	12.04 -	M 272.960	6	0,8	PLKR7A	4288		PLKR7A
C 350 4-Matic	203	3.5	200	12.04 -	M 272.970	6	0,8	PLKR7A	4288		PLKR7A
C 55 AMG	203	5.4	270	02.04 -	M 113.988 Twin Spark	8	1,0	IFR6D10	5344		LPG 1

**C COUPÉ C203**

CLC 160	203	1.6	95	02.09 -	M 271.911	4	0,8	PLKR7B8E	94716		PLKR7B8E
CLC 180 Kompressor	203	1.8	105	05.08 -	M 271.940 -> 30853899	4	0,8	ILFR6A	3588		ILFR6A
CLC 180 Kompressor	203	1.8	105	05.08 -	M 271.940 30853900 ->	4	0,8	PLKR7B8E	94716		PLKR7B8E
CLC 180 Kompressor	203	1.8	105	05.08 -	M 271.946 -> 30853899	4	0,8	ILFR6A	3588		ILFR6A
CLC 180 Kompressor	203	1.8	105	05.08 -	M 271.946 30853900 ->	4	0,8	PLKR7B8E	94716		PLKR7B8E
CLC 200 CDI	203	2.2	90	05.08 -	OM 646.962	4		Y-745U	6346	11	
CLC 200 Kompressor	203	1.8	135	05.08 -	M 271.957 30853900 ->	4	0,8	PLKR7B8E	94716		PLKR7B8E
CLC 220 CDI	203	2.2	110	05.08 -	OM 646.963	4		Y-745U	6346	11	
CLC 230	203	2.5	150	05.08 -	M 272.920	6	0,8	PLKR7A	4288		PLKR7A
CLC 350	203	3.5	200	05.08 -	M 272.960	6	0,8	PLKR7A	4288		PLKR7A

**C W/S 204**

C 180 CDI	204	2.2	88	01.10 -	OM 651.913	4		CZ303	7865	54	
C 180 Kompressor	204	1.8	115	01.07 -	M 271.952 30853900 ->	4	0,8	PLKR7B8E	94716		PLKR7B8E
C 180 Kompressor	204	1.6	115	01.08 -	M 271.910	4	0,8	PLKR7A	4288		PLKR7A
C 180 CGI	204	1.8	115	01.07 -	M 271.820	4	0,8	PLKR7B8E	94716		PLKR7B8E
C 200 CDI	204	2.2	100	08.07 - 12.09	OM 646.811	4		CZ106	9957	53	
C 200 CDI	204	2.2	100	01.10 -	OM 651.913	4		CZ303	7865	54	
C 200 CDI	204	2.2		10.07 - 12.09	OM 646.812	4		CZ106	9957	53	
C 200 CGI Kompressor	204	1.8	135	05.07 -	M 271.950 30853900 ->	4	0,8	PLKR7B8E	94716		PLKR7B8E
C 200 CGI	204	1.8	135	01.07 -	M 271.820	4	0,8	PLKR7B8E	94716		PLKR7B8E
C 220 CDI	204	2.2	125	05.07 - 11.08	OM 646.811	4		CZ106	9957	53	
C 220 CDI	204	2.2	125	12.08 -	OM 651.911	4		CZ303	7865	54	
C 220 CDI	204	2.2	150	12.08 -	OM 651.911	4		CZ303	7865	54	
C 230	204	2.5	150	08.07 -	M 272.921	6	0,8	PLKR7A	4288		PLKR7A
C 230 4-matic	204	2.5	150	01.07 -	M 272.911	6	0,8	PLKR7A	4288		PLKR7A
C 250 CDI	204	2.2	150	01.08 -	OM 651.911	4		CZ303	7865	54	
C 250 CDI 4-matic	204	2.2	150	01.11 -	OM 651.912	4		CZ303	7865	54	
C 250 CGI	204	1.8	150	07.09 -	M 271.860	4	0,8	PLKR7B8E	94716		PLKR7B8E
C 280	204	3.0	170	05.07 -	M 272.947	6	0,8	PLKR7A	4288		PLKR7A
C 280 4-Matic	204	3.0	170	05.07 -	M 272.948	6	0,8	PLKR7A	4288		PLKR7A
C 300	204	3.0	170	07.09 -	M 272.947	6	0,8	PLKR7A	4288		PLKR7A
C 300 4-Matic	204	3.0	170	07.07 -	M 272.948	6	0,8	PLKR7A	4288		PLKR7A

Code *l* kW

Cyl.

Stock-No.  
**VEINE**  
E-POWER

LPG/CNG

**MERCEDES****C W/S 204**

C 300 CDI 4-Matic	204	3.0	170	01.11 -	OM 642.832	6	█	CZ303	7865	54	
C 320 CDI	204	3.0	165	07.07 -	OM 642.960 / 961	6	█	Y8002AS	6287	51	
C 350	204	3.5	200	05.07 -	M 272.961	6	0,8	PLKR7A	4288		PLKR7A
C 350 4-Matic	204	3.5	200	05.07 -	M 272.971	6	0,8	PLKR7A	4288		PLKR7A
C 350 CGI	204	3.5		08 -	M 272.982	6	0,7	SILZKR7A-S	7718		SILZKR7A-S
C 350 CDI	204	3.0	165	07.09 -	OM 642.960 / 961	6	█	Y8002AS	6287	51	
C 350 CDI	204	3.0	170	09.09 -	OM 642.830	6	█	CZ303	7865	54	
C 350 CDI 4-Matic	204	3.0	170	04.09 -	OM 642.832	6	█	CZ303	7865	54	
C 63 AMG	204	6.3	336	08.07 -	M 156.985	8	1,0	ILZKAR7A10	6043		ILZKAR7A10
C 63 AMG	204	6.3	358	01.11 -	M 156.985	8	1,0	ILZKAR7A10	6043		ILZKAR7A10
C 63 AMG Coupé Black Series	204	6.3	380	01.12 -	M 156.985	8	1,0	ILZKAR7A10	6043		ILZKAR7A10

**CLK C208**

CLK 200	208	2.0	100	06.97 - 02	M 111.945	4		BKUR5ET	2789	29	LPG 1
CLK 200 Kompressor	208	2.0	120	06.00 - 06.02	M 111.956	4	1,0	IFR6D10	5344		LPG 1
CLK 200 Kompressor	208	2.0	135	07.97 - 02	M 111.944	4		BKUR6ET-10	2397	24	LPG 1
CLK 230 Kompressor	208	2.3	142	06.97 - 02.00	M 111.975	4		BKUR6ET-10	2397	24	LPG 1
CLK 230 Kompressor	208	2.3	145	03.00 - 06.02	M 111.982	4	1,0	IFR6D10	5344		LPG 1
CLK 320 V6	208	3.2	160	06.97 - 02	M 112.940 Twin Spark	6	1,1	PFR5R-11	4292		LPG 1
CLK 430	208	4.3	205	06.98 - 02	M 113.943 Twin Spark	8	1,1	PFR5R-11	4292		LPG 1
CLK 55	208	5.5	255	08.99 - 03	M 113.984 Twin Spark	8	1,1	PFR5R-11	4292		LPG 1

**CLK C209**

CLK 200 CGI	209	1.8	125	02.03 - 11.06	M 271.942 -> 30853899	4	0,8	ILFR6A	3588		ILFR6A
CLK 200 CGI	209	1.8	125	12.06 -	M 271.942 30853900 ->	4	0,8	PLKR7B8E	94716		PLKR7B8E
CLK 200 Kompressor	209	1.8	120	09.02 - 11.06	M 271.940 -> 30853899	4	0,8	ILFR6A	3588		ILFR6A
CLK 200 Kompressor	209	1.8	120	12.06 -	M 271.940 30853900 ->	4	0,8	PLKR7B8E	94716		PLKR7B8E
CLK 200 Kompressor	209	1.8	120	10.06 -	M 271.955 30853900 ->	4	0,8	PLKR7B8E	94716		PLKR7B8E
CLK 220 CDI	209	2.2	110	01.05 -	OM 646.963	4	█	Y-745U	6346	11	
CLK 220 CDI	209	2.2	110	01.05 -	OM 646.966	4	█	Y-745U	6346	11	
CLK 240	209	2.6	125	02.03 -	M 112.912 Twin Spark	6	1,1	PFR5R-11	4292		LPG 1
CLK 270 CDI	209	2.7	125	10.02 - 07.05	OM 612.962	5	█	Y-745U	6346	11	
CLK 270 CDI	209	2.7	125	10.02 - 07.05	OM 612.967	5	█	Y-745U	6346	11	
CLK 280	209	3.0	170	01.05 -	M 272.940	6	0,8	PLKR7A	4288		PLKR7A
CLK 320	209	3.2	160	03.03 -	M 112.955 Twin Spark	6	1,1	PFR5R-11	4292		LPG 1
CLK 320 CDI	209	3.0	165	01.05 -	OM 642.910	6	█	Y8002AS	6287	51	
CLK 350	209	3.5	200	01.05 -	M 272.960	6	0,8	PLKR7A	4288		PLKR7A
CLK 500	209	5.5	286	06 -	M 273.967	8	0,8	PLKR7A	4288		PLKR7A
CLK 500	209	5.0	225	06.02 -	M 113.968 Twin Spark	8	1,1	PFR5R-11	4292		LPG 1
CLK 55 AMG	209	5.4	270	09.02 -	M 113.987 Twin Spark	8	1,0	IFR6D10	5344		LPG 1
CLK 63 AMG	209	6.3	354	04.06 -	M 156.982	8	1,0	ILZKAR7A10	6043		ILZKAR7A10
CLK 63 AMG	209	6.3	373	05.07 -	M 156.982	8	1,0	ILZKAR7A10	6043		ILZKAR7A10

**CLS C218**

CLS 250 CDI	218	2.2	150	10.10 -	OM 651.924	4	█	CZ303	7865	54	
-------------	-----	-----	-----	---------	------------	---	---	-------	------	----	--

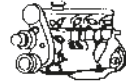
Code *l* kW

Cyl.

Stock-No.  
**VLIVE**  
10-14-15-16-17-18-19-20

LPG/CNG

**MERCEDES  
CLS C219**

CLS 280	219	3.0	170	07 -	M 272.943	6	0,8	PLKR7A	4288		PLKR7A
CLS 300	219	3.0	170	04.09 -	M 272.943	6	0,8	PLKR7A	4288		PLKR7A
CLS 320 CDI nicht für USA	219	3.0	165	01.05 -	OM 642.920	6	▣	Y8002AS	6287	51	
CLS 320 CDI nur für USA	219	3.0	165	01.05 -	OM 642.920	6	▣	CZ303	7865	54	
CLS 350	219	3.5	200	10.04 -	M 272.964	6	0,8	PLKR7A	4288		PLKR7A
CLS 350 CDI nicht für USA	219	3.0	165	04.09 -	OM 642.920	6	▣	Y8002AS	6287	51	
CLS 350 CDI nur für USA	219	3.0	165	04.09 -	OM 642.920	6	▣	CZ303	7865	54	
CLS 350 CGI	219	3.5	215	04.06 -	M 272.985	6	0,7	SILZKR7A-S	7718		SILZKR7A-S
CLS 500	219	5.5	286	04.06 -	M 273.960	8	0,8	PLKR7A	4288		PLKR7A
CLS 500	219	5.0	225	10.04 -	M 113.967 Twin Spark	8	1,1	PFR5R-11	4292		LPG 1
CLS 55 AMG	219	5.5	350	01.05 -	M 113.990 Twin Spark	8	0,8	ILFR6A	3588		ILFR6A
CLS 63 AMG	219	6.3	378	05.06 -	M 156.983	8	1,0	ILZKAR7A10	6043		ILZKAR7A10

**E W/S 124**

200 D	124	2.0	53	02.89 - 06.93	OM 601.912	4	▣	Y-916J	5906	6	
200 E	124	2.0	87	12.88 - 09.92	M 102.963	4	0,8	BP6EFS	3812	5	LPG 5
200 E	124	2.0	100	10.92 - 06.93	M 111.940	4	0,7	BCP6ES	4930	17	LPG 3
220 E	124	2.2	110	10.92 - 06.93	M 111.960	4	0,7	BCP6ES	4930	17	LPG 3
230 E	124	2.3	90	12.84 - 09.92	M 102.982	4	0,8	BP6EFS	3812	5	LPG 5
250 D	124	2.5	66	02.89 - 06.93	OM 602.912	5	▣	Y-916J	5906	6	
250 D Turbo	124	2.5	93	02.89 - 06.93	OM 602.962	5	▣	Y-916J	5906	6	
260 E	124	2.6	118	09.85 - 09.92	M 103.940/943	6	0,8	BP6EFS	3812	5	LPG 5
280 E	124	2.8	142	- 06.95	M 104.942	6	0,7	BCP6ES	4930	17	LPG 3
300 D	124	3.0	80	02.89 - 06.93	OM 603.912	6	▣	Y-916J	5906	6	
300 D 4-Matic	124	3.0	80	02.89 - 06.93	OM 603.913	6	▣	Y-916J	5906	6	
300 E	124	3.0	132	09.85 - 09.92	M 103.983	6	0,8	BP6EFS	3812	5	LPG 5
300 E 4-Matic	124	3.0	132	09.86 - 06.93	M 103.985	6	0,8	BP6EFS	3812	5	LPG 5
300 E-24V	124	3.0	162	09.89 - 06.93	M 104.980	6	0,7	BCP6ES	4930	17	LPG 3
300 TD	124	3.0	92	02.89 - 06.93	OM 603.960	6	▣	Y-916J	5906	6	
300 TD	124	3.0	108	02.89 - 06.93	OM 603.960	6	▣	Y-916J	5906	6	
300 TD 4Matic	124	3.0	105	02.89 - 06.93	OM 603.963	6	▣	Y-916J	5906	6	
320 E	124	3.2	162	10.92 - 06.93	M 104.992	6	0,7	BCP6ES	4930	17	LPG 3
400 E	124	4.2	205	10.92 - 06.93	M 119.975	8	0,7	BCP6ES	4930	17	LPG 3
500 E	124	5.0	235	06.91 - 06.93	M 119.974	8	0,7	BCP6ES	4930	17	LPG 3
E 200	124	2.0	100	06.93 - 06.97	M 111.942	4	0,7	BCP6ES	4930	17	LPG 3
E 200 D	124	2.0	53	07.93 - 05.95	OM 601.912	4	▣	Y-916J	5906	6	
E 220	124	2.2	110	06.93 - 06.95	M 111.960	4	0,7	BCP6ES	4930	17	LPG 3
E 250 D	124	2.5	66	07.93 -	OM 602.912/962	5	▣	Y-916J	5906	6	
E 250 D	124	2.5	83	07.93 - 05.95	OM 605.911	5	▣	◆ Y-930U §	4275	30	
E 250 D	124	2.5	83	07.93 - 04.96	OM 605.911/912	5	▣	Y-925J	6848	16	
E 250 Turbo-D	124	2.5	93	07.93 - 05.95	OM 602.962	5	▣	Y-916J	5906	6	
E 280	124	2.8	142	07.93 - 02.97	M 104.942	6	0,7	BCP6ES	4930	17	LPG 3
E 280	124	2.8	142	06.93 - 06.95	M 104.945	6	0,7	BCP6ES	4930	17	LPG 3
E 300 24V	124	3.0	162	06.93 - 06.97	M 104.980	6	0,7	BCP6ES	4930	17	LPG 3
E 300 4-Matic	124	3.0	132	09.86 - 06.93	M 103.985	6	0,8	BP6EFS	3812	5	LPG 5
E 300 D	124	3.0	100	07.93 - 05.95	OM 606.910	6	▣	◆ Y-930U §	4275	30	
E 300 D	124	3.0	100	06.95 - 06.96	OM 606.910	6	▣	Y-925J	6848	16	
E 300 Turbo-D	124	3.0	108	07.93 -	OM 603.960	6	▣	Y-916J	5906	6	
E 320	124	3.2	162	06.93 - 06.95	M 104.992	6	0,7	BCP6ES	4930	17	LPG 3
E 420	124	4.2	205	06.93 - 06.95	M 119.975	8	0,7	BCP6ES	4930	17	LPG 3
E 500	124	5.0	235	06.93 - 06.95	M 119.974	8	0,7	BCP6ES	4930	17	LPG 3



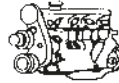

Code *l* kW

Cyl.

Stock-No.  
**VEINE**  
E-FORMER

LPG/CNG

**MERCEDES****E W/S 210**

E 200 D	210	2.0	65	01.96 - 03.02	OM 604.917	4	▣	Y-925J	6848	16	
E 200 CDI	210	2.2	75	06.98 - 06.99	OM 611.961	4	▣	Y-745U	6346	11	
E 200 CDI	210	2.2	85	07.99 - 03.03	OM 611.961	4	▣	Y-745U	6346	11	
E 200	210	2.0	100	06.95 - 06.97	M 111.942	4	0,8	BCP5ES	7496	16	LPG 3
E 200	210	2.0	100	07.97 - 08.00	M 111.942	4		BKUR5ET	2789	29	LPG 1
E 200 Kompressor	210	2.0	120	06.00 - 03.03	M 111.957	4	1,0	IFR6D10	5344		LPG 1
E 200 Kompressor	210	2.0	137	09.96 - 03.03	M 111.947	4		BKUR6ET-10	2397	24	LPG 1
E 220 D	210	2.2	55	05.96 - 03.02	OM 611.913	4	▣	Y-925J	6848	16	
E 220 D	210	2.2	70	03.95 - 03.02	OM 604.912	4	▣	Y-925J	6848	16	
E 220 CDI	210	2.2	92	06.98 - 06.99	OM 611.961	4	▣	Y-745U	6346	11	
E 220 CDI	210	2.2	105	07.99 - 03.03	OM 611.961	4	▣	Y-745U	6346	11	
E 230	210	2.3	110	06.95 - 06.97	M 111.970	4	0,8	BCP5ES	7496	16	LPG 3
E 240	210	2.6	125	06.00 - 03.03	M 112.914 Twin Spark	6	1,1	PFR5R-11	4292		LPG 1
E 240 V6	210	2.4	125	04.97 - 06.99	M 112.911 Twin Spark	6	1,1	PFR5R-11	4292		LPG 1
E 250 D	210	2.5	83	03.95 - 07.99	OM 605.912	5	▣	Y-925J	6848	16	
E 250 Turbo-D	210	2.5	110	06.97 - 07.99	OM 605.962	5	▣	Y-925J	6848	16	
E 270 CDI	210	2.7	105	07.99 - 03.03	OM 612.961	5	▣	Y-745U	6346	11	
E 280	210	2.8	142	01.96 - 06.99	M 104.945	6	0,8	BCP5ES	7496	16	LPG 3
E 280 V6	210	2.8	150	03.97 - 03.03	M 112.921 Twin Spark	6	1,1	PFR5R-11	4292		LPG 1
E 290 Turbo-D	210	2.9	95	06.95 - 07.99	OM 602.982	5	▣	Y-929U	1749	41	
E 300 D	210	3.0	100	03.95 - 06.97	OM 606.912	6	▣	Y-925J	6848	16	
E 300 Turbo-D	210	3.0	130	03.97 - 07.99	OM 606.962	6	▣	◆ Y-930U §	4275	30	
E 300 Turbo-D	210	3.0	130	03.97 - 07.99	OM 606.962	6	▣	Y-925J	6848	16	
E 320	210	3.2	170	06.95 - 05.99	M 104.995	6	0,8	BCP5ES	7496	16	LPG 3
E 320 V6	210	3.2	165	06.99 - 03.03	M 112.941 Twin Spark	6	1,1	PFR5R-11	4292		LPG 1
E 320 CDI	210	3.2	145	07.99 - 03.03	OM 613.961	6	▣	Y-745U	6346	11	
E 420 V8	210	4.2	205	07.97 - 05.98	M 119.985	8		BKUR5ET	2789	29	LPG 1
E 430 V8	210	4.3	205	04.97 - 03.03	M 113.940 Twin Spark	8	1,1	PFR5R-11	4292		LPG 1
E 50 AMG	210	5.0	255	02.96 - 08.97	M 119.985	8		BKR5EKU	3964		
E 50 AMG USA	210	5.0	235	02.96 - 05.99	M 119.980	8	0,7	BCP6ES	4930	17	LPG 3
E 55 AMG	210	5.5	260	09.97 - 03.03	M 113.980 Twin Spark	8	1,1	PFR5R-11	4292		LPG 1

**E W/S 211**

E 200 CDI	211	2.2	90	07.02 - 07.09	OM 646.951	4	▣	Y-745U	6346	11	
E 200 CDI	211	2.2	100	04.06 - 07.09	OM 646.820 / 821	4	▣	CZ106	9957	53	
E 200 Kompressor	211	1.8	120	11.02 - 11.06	M 271.941 -> 30853899	4	0,8	ILFR6A	3588		ILFR6A
E 200 Kompressor	211	1.8	120	12.06 - 07.09	M 271.941 30853900 ->	4	0,8	PLKR7B8E	94716		PLKR7B8E
E 200 Kompressor	211	1.8	135	04.06 - 11.06	M 271.956 -> 30853899	4	0,8	ILFR6A	3588		ILFR6A
E 200 Kompressor	211	1.8	135	12.06 - 07.09	M 271.956 30853900 ->	4	0,8	PLKR7B8E	94716		PLKR7B8E
E 200 NGT	211	1.8	120	03.04 - 11.06	M 271.941 -> 30853899	4	0,8	ILFR6A	3588		ILFR6A
E 200 NGT	211	1.8	120	12.06 - 07.09	M 271.941 30853900 ->	4	0,8	PLKR7B8E	94716		PLKR7B8E
E 220 CDI	211	2.2	110	03.03 - 07.09	OM 646.961	4	▣	Y-745U	6346	11	
E 220 CDI	211	2.2	125	04.06 - 07.09	OM 646.821	4	▣	CZ106	9957	53	
E 230	211	2.5	150	09.07 - 07.09	M 272.922	6	0,8	PLKR7A	4288		PLKR7A
E 240	211	2.6	130	03.02 - 07.09	M 112.913 Twin Spark	6	1,1	PFR5R-11	4292		LPG 1
E 240 4-matic	211	2.6	130	03.03 - 07.09	M 112.917 Twin Spark	6	1,1	PFR5R-11	4292		LPG 1

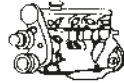

Code *l* kW

Cyl.

Stock-No.  
**VL**LINE  
10-15-17-19-20-21-23-25

LPG/CNG

**MERCEDES  
E W/S 211**

E 270 CDI	211	2.7	130	03.03 - 07.09	OM 647.961	5	☑	Y-745U	6346	11	
E 280	211	3.0	170	01.06 - 07.09	M 272.943	6	0,8	PLKR7A	4288		PLKR7A
E 280 4-matic	211	3.0	140	03.05 - 07.09	OM 642.921	6	☑	CZ303	7865	54	
E 280 4-Matic	211	3.0	170	01.06 - 07.09	M 272.944	6	0,8	PLKR7A	4288		PLKR7A
E 280 CDI	211	3.2	130	05.04 - 07.09	OM 648.961	6	☑	Y-745U	6346	11	
E 280 CDI nicht für USA	211	3.0	140	03.05 - 07.09	OM 642.920 / 921	6	☑	Y8002AS	6287	51	
E 280 CDI nur für USA	211	3.0	140	03.05 - 07.09	OM 642.920 / 921	6	☑	CZ303	7865	54	
E 300 CDI Bluetec	211	3.0	165	08 - 07.09	OM 642.920	6	☑	CZ303	7865	54	
E 320	211	3.2	165	03.02 - 07.09	M 112.949 Twin Spark	6	1,1	PFR5R-11	4292		LPG 1
E 320 4-matic	211	3.2	165	03.03 - 07.09	M 112.954 Twin Spark	6	1,1	PFR5R-11	4292		LPG 1
E 320 CDI	211	3.2	150	03.03 - 07.09	OM 648.961	6	☑	Y-745U	6346	11	
E 320 CDI nicht für USA	211	3.0	165	03.05 - 07.09	OM 642.920	6	☑	Y8002AS	6287	51	
E 320 CDI nur für USA	211	3.0	165	03.05 - 07.09	OM 642.920	6	☑	CZ303	7865	54	
E 320 CDI 4-matic nicht für USA	211	3.0	165	03.05 - 07.09	OM 642.921	6	☑	Y8002AS	6287	51	
E 320 CDI 4-matic nur für USA	211	3.0	165	03.05 - 07.09	OM 642.921	6	☑	CZ303	7865	54	
E 350	211	3.5	200	10.04 - 07.09	M 272.964	6	0,8	PLKR7A	4288		PLKR7A
E 350 4-matic	211	3.5	200	11.04 - 07.09	M 272.972	6	0,8	PLKR7A	4288		PLKR7A
E 350 CGI	211	3.5	215	08 - 07.09	M 272.985	6	0,7	SILZKR7A-S	7718		SILZKR7A-S
E 400 CDI	211	4.0	191	02.03 - 07.09	OM 628.961	8	☑	Y-745U	6346	11	
E 420 CDI	211	4.0	231	09.05 - 07.09	OM 629.910	8	☑	Y8002AS	6287	51	
E 420 CDI	211	4.0	231	01.06 - 07.09	OM 629.910	8	☑	Y8002AS	6287	51	
E 500	211	5.5	285	04.06 - 07.09	M 273.960	8	0,8	PLKR7A	4288		PLKR7A
E 500	211	5.5	300	04.06 - 07.09	M 273.962	8	0,8	PLKR7A	4288		PLKR7A
E 500	211	5.0	225	03.02 - 07.09	M 113.967 Twin Spark	8	1,1	PFR5R-11	4292		LPG 1
E 500 4-matic	211	5.0	225	03.03 - 07.09	M 113.969 Twin Spark	8	1,1	PFR5R-11	4292		LPG 1
E 55 AMG	211	5.5	350	10.02 - 07.09	M 113.990 Twin Spark	8	0,8	ILFR6A	3588		ILFR6A
E 63 AMG	211	6.3	378	05.06 - 07.09	M 156.983	8	1,0	ILZKAR7A10	6043		ILZKAR7A10

**E W/S 212**

E 200 CDI	212	2.2	100	05.09 -	OM 651.925	4	☑	CZ303	7865	54	
E 200 CGI	212	1.8	135	08.09 -	M 271.820	4	0,8	PLKR7B8E	94716		PLKR7B8E
E 200 CGI	212	1.8	135	08.09 -	M 271.860	4	0,8	PLKR7B8E	94716		PLKR7B8E
E 220 CDI	212	2.2	125	03.09 -	OM 651.924	4	☑	CZ303	7865	54	
E 250 CDI	212	2.2	150	03.09 -	OM 651.924	4	☑	CZ303	7865	54	
E 250 CGI	212	1.8	150	01.09 -	M 271.860	4	0,8	PLKR7B8E	94716		PLKR7B8E
E 300 CDI	212	3.0	170	03.10 -	OM 642.850	6	☑	CZ303	7865	54	
E 350 4-matic	212	3.5	200	01.09 -	M 272.977	6	0,8	PLKR7A	4288		PLKR7A
E 350 CDI BlueEfficiency	212	3.0	170	03.09 -	OM 642.850	6	☑	CZ303	7865	54	
E 350 CDI BlueTec	212	3.0	155	03.09 -	OM 642.850	6	☑	CZ303	7865	54	
E 350 CGI BlueEfficiency	212	3.5	215	03.09 -	M 272.983	6	0,7	SILZKR7A-S	7718		SILZKR7A-S
E 500	212	5.0	286	03.09 -	M 273.971	8	0,8	PLKR7A	4288		PLKR7A
E 63 AMG	212	6.3	386	12.09 -	M 156.985	8	1,0	ILZKAR7A10	6043		ILZKAR7A10

**E COUPÉ/CABRIOLET C/A 207**

E 220 CDI Coupé / Cabriolet	207	2.2	125	01.10 -	OM 651.911	4	☑	CZ303	7865	54	
E 250 CDI Coupé / Cabriolet	207	2.2	150	01.10 -	OM 651.911	4	☑	CZ303	7865	54	
E 350 CDI Coupé / Cabriolet	207	3.0	170	01.10 -	OM 642.836	4	☑	CZ303	7865	54	
E 200 CGI Coupé / Cabriolet	207	1.8	135	01.10 -	M 271.860	4	0,8	PLKR7B8E	94716		PLKR7B8E
E 250 CGI Coupé / Cabriolet	207	1.8	150	01.09 -	M 271.860	4	0,8	PLKR7B8E	94716		PLKR7B8E
E 350 CDI Coupé / Cabriolet	207	3.0	170	01.09 -	OM 642.836	6	☑	CZ303	7865	54	
E 350 CGI Coupé / Cabriolet	207	3.5	215	01.09 -	M 272.982	6	0,7	SILZKR7A-S	7718		SILZKR7A-S
E 500 Coupé / Cabriolet	207	5.5	286	01.09 -	M 273.966	8	0,8	PLKR7A	4288		PLKR7A

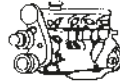
Code *l* kW

Cyl.

Stock-No.  
**VEINE**  
10-POWER

LPG/CNG

**MERCEDES****G W461**

230 GE	461	2.3	90	02.93 - 09.95	M 102.979	4	0,8	BP6EFS	3812	5	LPG 5
230 GE	461	2.3	92	04.92 - 09.95	M 102.981	4	0,8	BP6EFS	3812	5	LPG 5
230 GE	461	2.3	92	06.93 - 09.95	M 102.996	4	0,8	BP6EFS	3812	5	LPG 5
230 GE	461	2.3	92	04.92 - 09.95	M 102.998	4	0,8	BP6EFS	3812	5	LPG 5
250 GD	461	2.5	69	04.92 -	OM 602.939	5	█	Y-916J	5906	6	
280 GE	461	2.8	110	04.92 - 07.97	M 110.994	6	0,7	BP6ES	7811	4	LPG 2
290 GD	461	2.9	70	04.92 -	OM 602.942	5	█	Y-916J	5906	6	
290 GD Turbo	461	2.9	72	08.93 - 00.94	OM 602.942/947	6	█	Y-916J	5906	6	
290 GD Turbo	461	2.9	90	07.97 -	OM 602.983	5	█	Y-929U	1749	41	

**G W463**

200 GE	463	2.0	79	06.92 - 06.95	M 102.965	4	0,8	BP6EFS	3812	5	LPG 5
230 GE	463	2.3	93	09.89 - 07.93	M 102.989	4	0,8	BP6EFS	3812	5	LPG 5
250 GD	463	2.5	62	06.90 -	OM 602.931	5	█	Y-916J	5906	6	
300 GD	463	3.0	83	02.89 - 06.93	OM 603.931	6	█	Y-916J	5906	6	
300 GE	463	3.0	128	09.89 - 07.93	M 103.987	6	0,8	BP6EFS	3812	5	LPG 5
350 GD	463	3.5	100	09.91 - 06.93	OM 603.972	6	█	Y-916J	5906	6	
G 200	463	2.0	80	09.93 -	M 102.965	4	0,8	BP6EFS	3812	5	LPG 5
G 230	463	2.3	93	08.93 - 10.94	M 102.989	4	0,8	BP6EFS	3812	5	LPG 5
G 270 CDI	463	2.7	115	10.01 -	OM 612.965	5	█	Y-745U	6346	11	
G 300	463	3.0	126	08.93 - 10.94	M 103.987	6	0,8	BP6EFS	3812	5	LPG 5
G 300 D	463	3.0	83	08.93 -	OM 603.931	6	█	Y-916J	5906	6	
G 300 Turbo-D	463	3.0	130	08.96 -	OM 606.964	6	█	Y-925J	6848	16	
G 320	463	3.2	155	09.93 - 12.97	M 104.996	6	0,8	BCP5ES	7496	16	LPG 3
G 320	463	3.2	158	07.97 -	M 112.945 Twin Spark	6	1,1	PFR5R-11	4292		LPG 1
G 320 CDI	463	3.0	165	09.06 -	OM 642.970	6	█	CZ303	7865	54	
G 36 AMG	463	3.2	155	01.95 -	M 104.996	6	0,8	BCP5ES	7496	16	LPG 3
G 400 CDI	463	4.0	184	12.00 -	OM 628.962	8	█	Y-745U	6346	11	
G 500	463	5.0	195	08.93 - 10.94	M 117.965	8	0,7	BP6ES	7811	4	LPG 2
G 500	463	5.0	218	00 -	M 113.962 Twin Spark	8	1,1	PFR5R-11	4292		LPG 1
G 55 AMG	463	5.5	260	04.99 -	M 113.982 Twin Spark	8	1,1	PFR5R-11	4292		LPG 1
G 55 AMG	463	5.5	350	06.04 -	M 113.993 Twin Spark	8	0,8	ILFR6A	3588		ILFR6A
G 55 AMG	463	5.0	218	04.99 -	M 113.962 Twin Spark	8	1,1	PFR5R-11	4292		LPG 1

**GL X164**

GL 320 CDI nicht für USA	X164	3.0	165	01.06 -	OM 642.940	6	█	Y8002AS	6287	51	
GL 320 CDI nur für USA	X164	3.0	165	01.06 -	OM 642.940	6	█	CZ303	7865	54	
GL 350 CDI Bluetec	X164	3.0	155	06.09 -	OM 642.820	6	█	CZ303	7865	54	
GL 350 CDI nicht für USA	X164	3.0	165	05.09 -	OM 642.940	6	█	Y8002AS	6287	51	
GL 350 CDI nur für USA	X164	3.0	165	05.09 -	OM 642.940	6	█	CZ303	7865	54	
GL 420 CDI	X164	4.0	225	01.06 -	OM 629.912	8	█	Y8002AS	6287	51	
GL 450 CDI	X164	4.0	225	05.09 -	OM 629.912	8	█	Y8002AS	6287	51	
GL 450	X164	4.6	250	01.06 -	M 273.923	8	0,8	PLKR7A	4288		PLKR7A
GL 500	X164	5.5	286	01.06 -	M 273.963	8	0,8	PLKR7A	4288		PLKR7A

**GLK X204**

GLK 200 CDI	X204	2.2	105	07.10 -	OM 651.913	4	█	CZ303	7865	54	
GLK 220 CDI	X204	2.2	120	06.08 -	OM 651.912	4	█	CZ303	7865	54	
GLK 220 CDI	X204	2.2	120	06.08 -	OM 651.916	4	█	CZ303	7865	54	
GLK 220 CDI	X204	2.2	125	08.08 -	OM 651.916	4	█	CZ303	7865	54	
GLK 220 CDI	X204	2.2	125	06.08 -	OM 651.912	4	█	CZ303	7865	54	
GLK 250 CDI	X204	2.2	150	10.08 -	OM 651.912	4	█	CZ303	7865	54	
GLK 280	X204	3.0	170	06.08 - 06.09	M 272.948	6	0,8	PLKR7A	4288		PLKR7A

Code *l* kW

Cyl.



Stock-No.



LPG/CNG

**MERCEDES  
GLK X204**

GLK 300	X204	3.0	170	07.09 -	M 272.948	6	0,8	PLKR7A	4288		PLKR7A
GLK 320 CDI	X204	3.0	165	08.08 -	OM 642.961	6	█	Y8002AS	6287	51	
GLK 350 CDI	X204	3.0	165	06.09 -	OM 642.832	6	█	CZ303	7865	54	
GLK 350	X204	3.5	200	06.08 -	M 272.961	6	0,8	PLKR7A	4288		PLKR7A
GLK 350	X204	3.5	200	08 -	M 272.971	6	0,8	PLKR7A	4288		PLKR7A

**MB 100**

MB 100		2.4	43	02.89 -	OM 615.970	4	█	Y-924J	7906	1	
MB 100 D		2.4	56	02.89 -	OM 616.963	4	█	Y-916J	5906	6	

**M W163**

ML 230	163	2.3	110	02.98 - 06.05	M 111.977	4		BKUR5ET	2789	29	LPG 1
ML 270 CDI	163	2.7	120	12.99 - 06.05	OM 612.963	5	█	Y-745U	6346	11	
ML 320	163	3.2	160	02.98 - 08.02	M 112.942 Twin Spark	6	1,1	PFR5R-11	4292		LPG 1
ML 350	163	3.7	173	08.00 - 06.05	M 112.970 Twin Spark	6	1,1	PFR5R-11	4292		LPG 1
ML 400 CDI	163	4.0	184	09.00 - 06.05	OM 628.963	8	█	Y-745U	6346	11	
ML 430	163	4.3	200	11.98 - 06.05	M 113.942 Twin Spark	8	1,1	PFR5R-11	4292		LPG 1
ML 500	163	5.0	215	09.00 - 06.04	M 113.965 Twin Spark	8	1,1	PFR5R-11	4292		LPG 1
ML 55 AMG	163	5.5	255	11.99 - 06.05	M 113.981 Twin Spark	8	1,1	PFR5R-11	4292		LPG 1

**M W164**

ML 280 CDI nicht für USA	164	3.0	140	10.05 -	OM 642.940	6	█	Y8002AS	6287	51	
ML 280 CDI nur für USA	164	3.0	140	10.05 -	OM 642.940	6	█	CZ303	7865	54	
ML 300 CDI nicht für USA	164	3.0	140	06.09 -	OM 642.940	6	█	Y8002AS	6287	51	
ML 300 CDI nur für USA	164	3.0	140	06.09 -	OM 642.940	6	█	CZ303	7865	54	
ML 300 CDI	164	3.0	150	06.09 -	OM 642.820	6	█	CZ303	7865	54	
ML 320 CDI nicht für USA	164	3.0	165	07.05 -	OM 642.940	6	█	Y8002AS	6287	51	
ML 320 CDI nur für USA	164	3.0	165	07.05 -	OM 642.940	6	█	CZ303	7865	54	
ML 350 CDI	164	3.0	155	09.09 -	OM 642.820	6	█	CZ303	7865	54	
ML 350 CDI nicht für USA	164	3.0	165	06.09 -	OM 642.940	6	█	Y8002AS	6287	51	
ML 350 CDI nicht für USA	164	3.0	170	02.10 -	OM 642.940	6	█	Y8002AS	6287	51	
ML 350 CDI nur für USA	164	3.0	165	06.09 -	OM 642.940	6	█	CZ303	7865	54	
ML 350 CDI nur für USA	164	3.0	170	02.10 -	OM 642.940	6	█	CZ303	7865	54	
ML 350	164	3.5	200	07.05 -	M 272.967	6	0,8	PLKR7A	4288		PLKR7A
ML 420 CDI	164	4.0	225	02.06 -	OM 629.912	8	█	Y8002AS	6287	51	
ML 450 CDI	164	4.0	225	06.09 -	OM 629.912	8	█	Y8002AS	6287	51	
ML 500	164	5.0	225	12.04 -	M 113.964 Twin Spark	8	1,1	PFR5R-11	4292		LPG 1
ML 500	164	5.5	286	12.07 -	M 273.963	8	0,8	PLKR7A	4288		PLKR7A
ML 63 AMG	164	6.3	375	01.06 -	M 156.980	8	1,0	ILZKAR7A10	6043		ILZKAR7A10

**M W166**

ML 250 CDI	166	2.2	150	06.11 -	OM 651.960	4	█	CZ303	7865	54	
------------	-----	-----	-----	---------	------------	---	---	-------	------	----	--

**R W251**

R 280 CDI nicht für USA	251	3.0	140	05.06 -	OM 642.950	6	█	Y8002AS	6287	51	
R 280 CDI nur für USA	251	3.0	140	05.06 -	OM 642.950	6	█	CZ303	7865	54	
R 280	251	3.0	170	02.06 -	M 272.945	6	0,8	PLKR7A	4288		PLKR7A
R 300	251	3.0	170	07.09 -	M 272.945	6	0,8	PLKR7A	4288		PLKR7A
R 300 CDI nicht für USA	251	3.0	140	07.09 -	OM 642.950	6	█	Y8002AS	6287	51	
R 300 CDI nur für USA	251	3.0	140	07.09 -	OM 642.950	6	█	CZ303	7865	54	
R 320 CDI nicht für USA	251	3.0	165	02.06 -	OM 642.950	6	█	Y8002AS	6287	51	
R 320 CDI nur für USA	251	3.0	165	02.06 -	OM 642.950	6	█	CZ303	7865	54	
R 350 CDI Bluetec	251	3.0	155	07.09 -	OM 642.950	6	█	CZ303	7865	54	

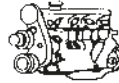

Code *l* kW

Cyl.

Stock-No.  
**VEINE**  
BY-PROMERZ

LPG/CNG

**MERCEDES****R W251**

R 350 CDI	251	3.0	165	07.09 -	OM 642.950	6	█	CZ303	7865	54	
R 350	251	3.5	200	02.06 -	M 272.967	6	0,8	PLKR7A	4288		PLKR7A
R 500	251	5.0	225	02.06 -	M 113.971 Twin Spark	8	1,1	PFR5R-11	4292		LPG 1
R 500	251	5.5	286	01.07 -	M 273.963	8	0,8	PLKR7A	4288		PLKR7A
R 63 AMG	251	6.3	375	11.05 -	M 156.980	8	1,0	ILZKAR7A10	6043		ILZKAR7A10

**S W140**

300 SE 2.8	140	2.8	142	02.93 - 10.98	M 104.944	6	0,7	BGP6ES	4930	17	LPG 3
300 SE/SEL 3,2	140	3.2	170	03.91 - 06.93	M 104.990	6	0,7	BGP6ES	4930	17	LPG 3
S 300 Turbo-D	140	3.0	130	05.96 - 10.98	OM 606.961	6	█	Y-916J	5906	6	
400 SE/SEL	140	4.2	210	02.91 - 06.93	M 119.971	8	0,7	BGP6ES	4930	17	LPG 3
500 SE/SEL	140	5.0	240	02.91 - 06.93	M 119.970	8	0,7	BGP6ES	4930	17	LPG 3
500 SEC	140	5.0	240	10.92 - 06.93	M 119.970	8	0,7	BGP6ES	4930	17	LPG 3
600 SE/SEL	140	6.0	290	04.91 - 06.93	M 120.980	12	0,7	BGP6ES	4930	17	LPG 3
600 SEC	140	6.0	290	10.92 - 06.93	M 120.980	12	0,7	BGP6ES	4930	17	LPG 3
S 280	140	2.8	142	07.93 - 06.97	M 104.944	6	0,7	BGP6ES	4930	17	LPG 3
S 300	140	3.0	130	05.96 - 10.98	OM 606.961	6	█	◆ Y-930U §	4275	30	
S 300	140	3.0	130	05.96 - 10.98	OM 606.961	6	█	Y-925J	6848	16	
S 320	140	3.2	170	07.93 - 06.97	M 104.994	6	0,7	BGP6ES	4930	17	LPG 3
S 350 Turbo-D	140	3.5	110	01.93 - 10.98	OM 603.971	6	█	Y-916J	5906	6	
S 420	140	4.2	205	07.93 - 06.97	M 119.971	8	0,7	BGP6ES	4930	17	LPG 3
S 420	140	4.2	205	06.93 - 06.97	M 119.981	8	0,7	BGP6ES	4930	17	LPG 3
S 500	140	5.0	235	07.93 - 06.97	M 119.970	8	0,7	BGP6ES	4930	17	LPG 3
S 600	140	6.0	290	07.93 - 06.97	M 120.980	12	0,7	BGP6ES	4930	17	LPG 3
S 600	140	6.0	290	06.93 - 06.97	M 120.982	12	0,7	BGP6ES	4930	17	LPG 3

**S W220**

S 280	220	2.8	142	10.99 - 08.05	M 112.922 Twin Spark	6	1,1	PFR5R-11	4292		LPG 1
S 320	220	3.2	165	10.98 - 08.05	M 112.944 Twin Spark	6	1,1	PFR5R-11	4292		LPG 1
S 320 CDI	220	3.2	145	08.99 - 09.02	OM 613.960	6	█	Y-745U	6346	11	
S 320 CDI	220	3.2	150	09.02 - 08.05	OM 648.960	6	█	Y-745U	6346	11	
S 350	220	3.7	180	09.02 - 08.05	M 112.972 Twin Spark	6	1,1	PFR5R-11	4292		LPG 1
S 350 4-matic	220	3.7	180	06.03 - 08.05	M 112.975 Twin Spark	6	1,1	PFR5R-11	4292		LPG 1
S 400 CDI	220	4.0	184	06.00 - 08.05	OM 628.960	8	█	Y-745U	6346	11	
S 400 CDI	220	4.0	191	06.03 - 08.05	OM 628.960	8	█	Y-745U	6346	11	
S 430	220	4.3	205	10.98 - 08.05	M 113.941 Twin Spark	8	1,1	PFR5R-11	4292		LPG 1
S 430 4-matic	220	4.3	205	09.02 - 08.05	M 113.948 Twin Spark	8	1,1	PFR5R-11	4292		LPG 1
S 500	220	5.0	225	10.98 - 08.05	M 113.960 Twin Spark	8	1,1	PFR5R-11	4292		LPG 1
S 500 4-matic	220	5.0	225	09.02 - 08.05	M 113.966 Twin Spark	8	1,1	PFR5R-11	4292		LPG 1
S 55 AMG	220	5.5	265	99 - 08.05	M 113.980 Twin Spark	8	1,1	PFR5R-11	4292		LPG 1
S 55 AMG	220	5.5	265	04.99 - 08.05	M 113.986 Twin Spark	8	1,1	PFR5R-11	4292		LPG 1
S 55 AMG Kompressor	220	5.5	368	02 - 08.05	M 113.991 Twin Spark	8	0,8	ILFR6A	3588		ILFR6A
S 600	220	6.0	270	01.00 - 08.05	M 137.970 Twin Spark	12	0,8	IFR6Q-G	5648		IFR6Q-G
S 600	220	6.0	368	01 - 08.05	M 275.950 Twin Spark	12	0,8	IFR6Q-G	5648		IFR6Q-G
S 65 AMG	220	6.0	450	03 - 08.05	M 275.980 Twin Spark	12	0,8	IFR6Q-G	5648		IFR6Q-G

**S W221**

S 250 CDI	221	2.2	150	01.11 -	OM 651.961	4	█	CZ303	7865	54	
S 280	221	3.0	170	05 -	M 272.946	6	0,8	PLKR7A	4288		PLKR7A
S 320 CDI	221	3.0	173	03.06 -	OM 642.930	6	█	Y8002AS	6287	51	
S 320 CDI 4-Matic	221	3.0	173	10.06 -	OM 642.932	6	█	Y8002AS	6287	51	
S 350	221	3.5	200	10.05 -	M 272.965	6	0,8	PLKR7A	4288		PLKR7A



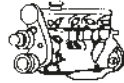

Code *l* kW

Cyl.



Stock-No.



LPG/CNG

**MERCEDES****S W221**

S 350 4Matic	221	3.5	200	06.07 -	M 272.965	6	0,8	PLKR7A	4288		PLKR7A
S 400 BlueHybrid	221	3.5	205	01.09 -	M 272.974	6	0,8	PLKR7A	4288		PLKR7A
S 420 CDI	221	4.0	235	10.06 -	OM 629.911	8		Y8002AS	6287	51	
S 450	221	4.6	250	07.05 -	M 273.922	8	0,8	PLKR7A	4288		PLKR7A
S 450 4-Matic	221	4.6	250	12.05 -	M 273.924	8	0,8	PLKR7A	4288		PLKR7A
S 500	221	5.5	285	07.05 -	M 273.961	8	0,8	PLKR7A	4288		PLKR7A
S 500 4-Matic	221	5.5	285	10.05 -	M 273.968	8	0,8	PLKR7A	4288		PLKR7A
S 600	221	6.0	380	03.06 -	M 275.953 Twin Spark	12	0,8	IFR6Q-G	5648		IFR6Q-G
S 63 AMG	221	6.3	386	10.06 -	M 156.984	8	1,0	ILZKAR7A10	6043		ILZKAR7A10
S 65 AMG	221	6.0	450	12.05 -	M 275.982 Twin Spark	12	0,8	IFR6Q-G	5648		IFR6Q-G

**S COUPÉ C140**

CL 420	140	4.2	205	06.96 - 06.97	M 119.981	8	0,7	BCP6ES	4930	17	LPG 3
CL 420	140	4.2	205	07.97 - 10.98	M 119.981	8	1,1	PFR5R-11	4292		LPG 1
CL 500	140	5.0	235	09.96 - 06.97	M 119.980	8	1,1	PFR5R-11	4292		LPG 1
CL 500	140	5.0	235	07.97 - 10.98	M 119.980	8	1,1	PFR5R-11	4292		LPG 1
CL 600	140	6.0	290	06.96 - 05.97	M 120.982	12	0,7	BCP6ES	4930	17	LPG 3
CL 600	140	6.0	290	06.97 - 10.98	M 120.982	12	1,1	PFR5R-11	4292		LPG 1

**S COUPÉ C215**

CL 500	215	5.0	225	09.00 - 03.06	M 113.960 Twin Spark	8	1,1	PFR5R-11	4292		LPG 1
CL 55 AMG	215	5.5	265	10.99 - 03.06	M 113.986 Twin Spark	8	1,1	PFR5R-11	4292		LPG 1
CL 55 AMG Kompressor	215	5.5	386	00 - 03.06	M 113.991 Twin Spark	8	0,8	ILFR6A	3588		ILFR6A
CL 600	215	6.0	270	03.99 - 03.06	M 137.970 Twin Spark	12	0,8	IFR6Q-G	5648		IFR6Q-G
CL 65 AMG	215	6.0	450	09.03 - 03.06	M 275.980 Twin Spark	12	0,8	IFR6Q-G	5648		IFR6Q-G

**S COUPÉ C216**

CL 500	216	5.5	286	10.06 -	M 273.961	8	0,8	PLKR7A	4288		PLKR7A
CL 500 4matic	216	5.5	286	02.08 -	M 273.968	8	0,8	PLKR7A	4288		PLKR7A
CL 600	216	6.0	368	02 - 03.06	M 275.950 Twin Spark	12	0,8	IFR6Q-G	5648		IFR6Q-G
CL 600	216	6.0	381	09.06 -	M 275.953 Twin Spark	12	0,8	IFR6Q-G	5648		IFR6Q-G
CL 63 AMG	216	6.3	386	09.06 -	M 156.984	8	1,0	ILZKAR7A10	6043		ILZKAR7A10
CL 65 AMG	216	6.0	450	10.06 -	M 275.982 Twin Spark	12	0,8	IFR6Q-G	5648		IFR6Q-G

**SL R129**

300 SL	129	3.0	140	03.89 - 06.93	M 103.984	6	0,8	BP6EFS	3812	5	LPG 5
300 SL-24V	129	3.0	170	07.89 - 06.93	M 104.981	6	0,7	BCP6ES	4930	17	LPG 3
500 SL	129	5.0	235	09.92 - 06.93	M 119.972	8	0,7	BCP6ES	4930	17	LPG 3
500 SL	129	5.0	240	03.89 - 06.93	M 119.960	8	0,7	BCP6ES	4930	17	LPG 3
600 SL	129	6.0	290	07.92 - 06.93	M 120.981	12	0,7	BCP6ES	4930	17	LPG 3
SL 280	129	2.8	141	07.93 - 06.97	M 104.943	6	0,7	BCP6ES	4930	17	LPG 3
SL 280	129	2.8	142	07.97 - 05.98	M 104.943	6		BKUR5ET	2789	29	LPG 1
SL 280	129	2.8	150	06.98 -	M 112.923 Twin Spark	6	1,1	PFR5R-11	4292		LPG 1
SL 320	129	3.2	165	06.98 -	M 112.943 Twin Spark	6	1,1	PFR5R-11	4292		LPG 1
SL 320	129	3.2	170	07.93 - 06.97	M 104.991	6	0,7	BCP6ES	4930	17	LPG 3
SL 320	129	3.2	170	07.97 - 05.98	M 104.991	6		BKUR5ET	2789	29	LPG 1
SL 500	129	5.0	225	98 -	M 113.961 Twin Spark	8	1,1	PFR5R-11	4292		LPG 1
SL 500	129	5.0	235	07.93 - 06.97	M 119.972	8	0,7	BCP6ES	4930	17	LPG 3
SL 500	129	5.0	235	07.93 - 06.97	M 119.982	8	0,7	BCP6ES	4930	17	LPG 3
SL 60	129	6.0	280	95 -	M 119.E60	12		BKR5EKU	3964		
SL 60 AMG	129	6.0	280	95 -	M 119.E60	12		BKR5EKU	3964		
SL 600	129	6.0	290	07.93 - 06.97	M 120.981	12	0,7	BCP6ES	4930	17	LPG 3

Code *l* kW

Cyl.



Stock-No.

VETINE

LPG/CNG

**MERCEDES****SL R129**

SL 600	129	6.0	290	07.93 - 06.97	M 120.983	12	0,8	BCP5ES	7496	16	LPG 3
SL 600	129	6.0	290	98 -	M 120.983	12	1,1	PFR5R-11	4292		LPG 1
SL 73 AMG	129	7.3	386	99 -	M 120.E73	12	1,1	PFR5R-11	4292		LPG 1

**SL R230**

SL 280	230	3.0	170	03.08 -	M 272.949	6	0,8	PLKR7A	4288		PLKR7A
SL 300	230	3.0	170	04.09 -	M 272.949	6	0,8	PLKR7A	4288		PLKR7A
SL 350	230	3.5	200	05.05 -	M 272.966	6	0,8	PLKR7A	4288		PLKR7A
SL 350	230	3.5	233	04.08 -	M 272.968	6	0,8	PLKR7A	4288		PLKR7A
SL 350	230	3.7	180	03.03 -	M 112.973 Twin Spark	6	1,1	PFR5R-11	4292		LPG 1
SL 500	230	5.5	286	03.06 -	M 273.965	8	0,8	PLKR7A	4288		PLKR7A
SL 500	230	5.0	225	10.01 -	M 113.963 Twin Spark	8	1,1	PFR5R-11	4292		LPG 1
SL 55 AMG	230	5.5	350	10.01 - 06.02	M 113.992 Twin Spark	8	0,8	ILFR6A	3588		ILFR6A
SL 55 AMG	230	5.5	368	06.02 -	M 113.992 Twin Spark	8	0,8	ILFR6A	3588		ILFR6A
SL 55 AMG	230	5.5	380	03.06 -	M 113.995 Twin Spark	8	0,8	ILFR6A	3588		ILFR6A
SL 600	230	5.5	368	04.03 -	M 275.951 Twin Spark	12	0,8	IFR6Q-G	5648		IFR6Q-G
SL 600	230	5.5	381	03.06 -	M 275.954 Twin Spark	12	0,8	IFR6Q-G	5648		IFR6Q-G
SL 63 AMG	230	6.3	386	03.08 -	M 156.981	8	1,0	ILZKAR7A10	6043		ILZKAR7A10
SL 65 AMG	230	6.0	450	03.04 -	M 275.981 Twin Spark	12	0,8	IFR6Q-G	5648		IFR6Q-G

**SLK R170**

SLK 200	170	2.0	100	09.96 -	M 111.946	4		BKUR5ET	2789	29	LPG 1
SLK 200 Kompressor	170	2.0	120	03.00 -	M 111.958	4	1,0	IFR6D10	5344		LPG 1
SLK 200 Kompressor	170	2.0	141	09.96 - 02.00	M 111.943	4		BKUR6ET-10	2397	24	LPG 1
SLK 230 Kompressor	170	2.3	142	09.96 - 02.00	M 111.973	4		BKUR6ET-10	2397	24	LPG 1
SLK 230 Kompressor	170	2.3	145	03.00 -	M 111.983	4	1,0	IFR6D10	5344		LPG 1
SLK 32 AMG	170	3.2	260	01 -	M 112.960 Twin Spark	6	1,0	IFR6D10	5344		LPG 1
SLK 32 AMG Kompressor	170	3.2	260	11.00 -	M 112.960 Twin Spark	6	1,0	IFR6D10	5344		LPG 1
SLK 320	170	3.2	160	03.00 -	M 112.947 Twin Spark	6	1,1	PFR5R-11	4292		LPG 1

**SLK R171**

SLK 200 Kompressor	171	1.8	120	04.04 - 11.06	M 271.944 -> 30853899	4	0,8	ILFR6A	3588		ILFR6A
SLK 200 Kompressor	171	1.8	120	12.06 - 12.10	M 271.944 30853900 ->	4	0,8	PLKR7B8E	94716		PLKR7B8E
SLK 200 Kompressor	171	1.8	135	01.08 - 12.10	M 271.954 30853900 ->	4	0,8	PLKR7B8E	94716		PLKR7B8E
SLK 250	171	1.8	150	02.11 -	M 271.861	4	0,8	PLKR7B8E	94716		PLKR7B8E
SLK 280	171	3.0	170	01.05 -	M 272.942	6	0,8	PLKR7A	4288		PLKR7A
SLK 300	171	3.0	170	04.09 -	M 272.942	6	0,8	PLKR7A	4288		PLKR7A
SLK 350	171	3.5	200	06.04 -	M 272.963	6	0,8	PLKR7A	4288		PLKR7A
SLK 350	171	3.5	224	01.08 -	M 272.969	6	0,8	PLKR7A	4288		PLKR7A
SLK 55 AMG	171	5.5	265	04.04 -	M 113.989 Twin Spark	8	1,0	IFR6D10	5344		LPG 1

**SLK R172**

SLK 200	172	1.8	135	02.11 -	M 271.861	4	0,8	PLKR7B8E	94716		PLKR7B8E
SLK 250	172	1.8	150	02.11 -	M 271.861	4	0,8	PLKR7B8E	94716		PLKR7B8E
SLK 250 Cdi	172	2.2	150	01.12 -	OM 651.980	4		CZ303	7865	54	

**SLR**

SLR Mc Laren	199	5.4	460	04.04 - 01.10	M 155.980 Twin Spark	8	0,8	ILFR6A	3588		ILFR6A
--------------	-----	-----	-----	---------------	----------------------	---	-----	--------	------	--	--------

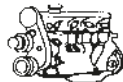
Code *l* kW

Cyl.

Stock-No.  

LPG/CNG

**MERCEDES  
SPRINTER 901 / 902**

Sprinter 208 CDI	901/902	2.2	60	04.00 -				Y-745U	6346	11	
Sprinter 208 D	901/902	2.3	58	04.95 -	OM 601....	4		Y-916J	5906	6	
Sprinter 211 CDI	901/902	2.2	80	04.00 -				Y-745U	6346	11	
Sprinter 212 D	901/902	2.9	90	04.95 -	OM 602.980.10 DELA ->9849	5		Y-923U	3380	1	
Sprinter 212 D	901/902	2.9	90	04.95 -	OM 602.980.10 DELA 9850->	5		Y-929U	1749	41	
Sprinter 212 D	901/902	2.9	90	04.95 -	OM 602.980.12 DELA ->136	5		Y-923U	3380	1	
Sprinter 212 D	901/902	2.9	90	04.95 -	OM 602.980.12 DELA 137 ->	5		Y-929U	1749	41	
Sprinter 213 CDI	901/902	2.1	95	04.00 -				Y-745U	6346	11	
Sprinter 214	901/902	2.3	105	04.95 -	M 111.979	4		BKUR5ET	2789	29	LPG 1
Sprinter 216 CDI	901/902	2.7	115	04.00 -				Y-745U	6346	11	

**SPRINTER 903**

Sprinter 308 CDI	903	2.2	60	04.00 -				Y-745U	6346	11	
Sprinter 308 D	903	2.3	58	04.95 - 00	OM 601.....	4		Y-916J	5906	6	
Sprinter 311 CDI	903	2.1	80	04.00 -	OM 611.981	4		Y-745U	6346	11	
Sprinter 312 D	903	2.9	90	04.95 - 04.00	OM 602.980.10 DELA ->9849	5		Y-923U	3380	1	
Sprinter 312 D	903	2.9	90	04.95 - 04.00	OM 602.980.10 DELA9850->	5		Y-929U	1749	41	
Sprinter 312 D	903	2.9	90	04.95 - 04.00	OM 602.980.12 DELA ->136	5		Y-923U	3380	1	
Sprinter 312 D	903	2.9	90	04.95 - 04.00	OM 602.980.12 DELA 137 ->	5		Y-929U	1749	41	
Sprinter 313 CDI	903	2.1	95	04.00 -				Y-745U	6346	11	
Sprinter 314	903	2.3	105	04.95 -	M 111.979	4		BKUR5ET	2789	29	LPG 1
Sprinter 316 CDI	903	2.7	115	04.00 -				Y-745U	6346	11	

**SPRINTER 904**

Sprinter 412 D	904	2.9	90	04.95 -	OM 602.980.10 DELA ->9849	5		Y-923U	3380	1	
Sprinter 412 D	904	2.9	90	04.95 -	OM 602.980.10 DELA 9850 ->	5		Y-929U	1749	41	
Sprinter 412 D	904	2.9	90	04.95 -	OM 602.980.12 DELA ->136	5		Y-923U	3380	1	
Sprinter 412 D	904	2.9	90	04.95 -	OM 602.980.12 DELA 137 ->	5		Y-929U	1749	41	

**SPRINTER 906**

Sprinter 209 CDI	906	2.2	65	06.06 -	OM 646.984	4		Y-745U	6346	11	
Sprinter 209 CDI	906	2.2	80	06.06 -	OM 646.985	4		Y-745U	6346	11	
Sprinter 209 CDI	906	3.0	135	06.06 -	OM 642.992	4		CZ303	7865	54	
Sprinter 209 CDI	906	3.0		06.06 -	OM 642.896	4		CZ303	7865	54	
Sprinter 210 CDI	906	2.2	70	03.09 -	OM 651.955	4		CZ303	7865	54	
Sprinter 213 CDI	906	2.2	95	03.09 -	OM 651.956	4		CZ303	7865	54	
Sprinter 216	906	1.8	115	09.08 -	M 271.951	4	0,8	PLKR7B8E	94716		
Sprinter 216 CDI	906	2.2	120	03.09 -	OM 651.957	4		CZ303	7865	54	
Sprinter 218 CDI	906	3.0	135	06.06 -	OM 642.992	6		Y8002AS	6287	51	

Code *l* kW

Cyl.

Stock-No.  
**VETINE**  
BY-PROMOTRA

LPG/CNG

**MERCEDES****SPRINTER 906**

Sprinter 219 CDI	906	3.0	140	03.09 -	OM 642.992	6	█	CZ303	7865	54	
Sprinter 224	906	3.5	190	06.06 -	M 272.979	6	0,8	PLKR7A	4288		
Sprinter 310 CDI	906	2.2	70	03.09 -	OM 651.955	4	█	CZ303	7865	54	
Sprinter 313 CDI	906	2.2	95	06.06 -	OM 651.956	4	█	CZ303	7865	54	
Sprinter 313 CDI	906	2.2	95	08.11 -	OM 651.955	4	█	CZ303	7865	54	
Sprinter 316	906	1.8	115	09.08 -	M 271.951	4	0,8	PLKR7B8E	94716		
Sprinter 316 NGT	906	1.8	115	09.08 -	M 271.951	4	0,8	PLKR7B8E	94716		
Sprinter 316 CDI	906	2.2	120	03.09 -	OM 651.957	4	█	CZ303	7865	54	
Sprinter 318 CDI	906	3.0	135	06.06 -	OM 642.992	6	█	Y8002AS	6287	51	
Sprinter 319 CDI	906	3.0	140	03.09 -	OM 642.992	6	█	Y8002AS	6287	51	
Sprinter 324	906	3.5	190	06.06 -	M 272.979	6	0,8	PLKR7A	4288		
Sprinter 413 CDI	906	2.2	95	06.06 -	OM 651.956	4	█	Y8002AS	6287	51	
Sprinter 416 CDI	906	2.2	120	03.09 -	OM 651.957	4	█	CZ303	7865	54	
Sprinter 419 CDI	906	3.0	140	03.09 -	OM 642.992	6	█	Y8002AS	6287	51	
Sprinter 424	906	3.5	190	06.06 -	M 272.979	6	0,8	PLKR7A	4288		
Sprinter 510 CDI	906	2.2	70	03.09 -	OM 651.955	4	█	CZ303	7865	54	
Sprinter 513 CDI	906	2.2	95	03.09 -	OM 651.956	4	█	CZ303	7865	54	
Sprinter 516	906	1.8	115	09.08 -	M 271.951	4	0,8	PLKR7B8E	94716		
Sprinter 516 NGT	906	1.8	115	09.08 -	M 271.951	4	0,8	PLKR7B8E	94716		
Sprinter 516 CDI	906	2.2	120	03.09 -	OM 651.957	4	█	CZ303	7865	54	
Sprinter 518 CDI	906	3.0	135	06.06 -	OM 642.992	6	█	Y8002AS	6287	51	
Sprinter 519 CDI	906	3.0	140	03.09 -	OM 642.992	6	█	Y8002AS	6287	51	
Sprinter 524	906	3.5	190	06.06 -	M 272.979	6	0,8	PLKR7A	4288		

**UNIMOG**

Unimog 100 L		2.9	71	11.92 -	OM 602.948	5	█	Y-916J	5906	6	
Unimog 600/650		2.4	38	01.88 -	OM 616.	4	█	Y-924J	7906	1	
Unimog U 90		3.0	65	11.92 -	OM 602.941	5	█	Y-916J	5906	6	

**VANEO 414**

Vaneo	414	1.6	60	01.02 -	M 166.961	4		BKUR5ET	2789	29	LPG 1
Vaneo	414	1.6	75	01.02 -	M 166.961	4		BKUR5ET	2789	29	LPG 1
Vaneo CDI	414	1.7	55	01.02 -	OM 668.914	4	█	Y-746R	4842	38	
Vaneo CDI	414	1.7	67	01.02 -	OM 668.914	4	█	Y-746R	4842	38	
Vaneo	414	1.9	92	01.02 -	M 166.991	4		BKUR5ET	2789	29	LPG 1

**VIANO 639**

Viano 2.0I CDI	639	2.2	80	07.03 -	OM 646.982	4	█	Y-745U	6346	11	
Viano 2.2I CDI	639	2.2	100	07.10 -	OM 651.940	4	█	CZ303	7865	54	
Viano 2.2I CDI	639	2.2	110	09.03 -	OM 646.983	4	█	Y-745U	6346	11	
Viano 2.2I CDI	639	2.2	120	07.10 -	OM 651.940	4	█	CZ303	7865	54	
Viano 3.0I	639	3.2	140	09.03 -	M 112.951 Twin Spark	6	1,1	PFR5R-11	4292		LPG 1
Viano 3.0I CDI	639	3.0	150	08.05 -	OM 642.990	6	█	Y8002AS	6287	51	
Viano 3.0I CDI	639	3.0	165	07.10 -	OM 642.990	6	█	Y8002AS	6287	51	
Viano 3.2I	639	3.2	190	09.05 -	M 272.978	6	0,8	PLKR7A	4288		PLKR7A
Viano 3.5I	639	3.5	190	09.07 -	M 272.979	6	0,8	PLKR7A	4288		PLKR7A
Viano 3.5I	639	3.7	170	01.05 -	M 112.976 Twin Spark	6	1,1	PFR5R-11	4292		LPG 1

**VITO 638**

Vito 113	638	2.0	95	03.96 -	M 111.948/950	4		BKUR5ET-10	7553		LPG 1
Vito 108 D	638	2.3	60	02.96 -	OM 601.942	4	█	Y-916J	5906	6	
Vito 110 D	638	2.3	72	02.96 -	OM 601.970	4	█	Y-916J	5906	6	
Vito 114	638	2.3	105	03.96 - 07.03	M 111.978	4		BKUR5ET-10	7553		LPG 1

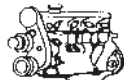
Code *l* kW

Cyl.



Stock-No.



LPG/CNG

**MERCEDES  
VITO 639**

Vito 110 CDI	639	2.2	70	09.10 -	OM 651.940	4		CZ303	7865	54	
Vito 113 CDI	639	2.2	100	07.10 -	OM 651.940	4		CZ303	7865	54	
Vito 116 CDI	639	2.2	120	09.10 -	OM 651.940	4		CZ303	7865	54	
Vito 120 CDI	639	3.0	150	03.06 -	OM 642.990	6		Y8002AS	6287	51	
Vito 122 CDI	639	3.0	165	09.10 -	OM 642.990	6		Y8002AS	6287	51	
Vito 3.5l	639	3.5	190	09.07 -	M 272.978	6	0,8	PLKR7A	4288		PLKR7A

**V 638**

V 200 CDI	638	2.2	75	03.99 - 07.03	OM 611.980	4		Y-745U	6346	11	
V 220 CDI	638	2.2	90	03.99 - 07.03	OM 611.980	4		Y-745U	6346	11	
V 230	638	2.3	105	09.96 -	M 111.978	4		BKR6EK	2288	20	LPG 1
V 230 TD	638	2.3	72	09.96 -	OM 601.970	4		Y-916J	5906	6	
V 280 VR6	638	2.8	125	98 -	M 104.900(AFS)	6		BKR5EKUP	2890		

**MG**

MGF 1.6		1.6	81	02.00 -	K Series	4	1,1	PFR6N-11	3546		LPG 1
MGF Roadster		1.8	88	11.95 -	NPI	4	1,1	PFR6N-11	3546		LPG 1
MGF Roadster		1.8	106	11.95 -	VV10	4	1,1	PFR6N-11	3546		LPG 1
MGF Trophy 160 SE		1.8	116	02.95 -	K Series WVC	4	1,0	PFR6N-11	3546		LPG 1
MGTF 1.6		1.6	85	03.02 -	K Series	4	1,0	PFR6N-11	3546		LPG 1
MGTF 1.8		1.8	88	03.02 -	K Series	4	1,0	PRF6N-11	3546		
MGTF 1.8		1.8	99	03.02 -	K Series	4	1,0	PFR6N-11	3546		LPG 1
MGTF 1.8		1.8	118	03.02 -	K Series	4	1,0	PFR6N-11	3546		LPG 1
RV 8		3.9	140	10.92 - 10.95	Rover V8 Efi	8	0,8	BPR6ES	7822	2	LPG 2
ZR 105		1.4	74	06.01 -	K	4	1,1	PFR6N-11	3546		LPG 1
ZR 105		1.4	74	06.01 -	K	4	1,1	PFR6N-11	3546		LPG 1
ZR 120		1.8	85	06.01 -	K	4	1,1	PFR6N-11	3546		LPG 1
ZR 120		1.8	85	06.01 -	K	4	1,1	PFR6N-11	3546		LPG 1
ZR 160		1.8	116	06.01 -	K WVC	4	1,1	PFR6N-11	3546		LPG 1
ZR TD		2.0		06.01 -		4		Y-730U	6704	17	
ZR TD		2.0		12.02 -		4		Y-730U	6704	17	
ZS 110		1.6		07.03 -	K Series	4	1,1	PFR6N-11	3546		LPG 1
ZS 120		1.8	85	06.01 -	K	4	1,1	PFR6N-11	3546		LPG 1
ZS 120		1.8	88	06.01 -	K	4	1,1	PFR6N-11	3546		LPG 1
ZS TD		2.0		08.02 -		4		Y-730U	6704	17	
ZS TD		2.0		12.02 -		4		Y-730U	6704	17	
ZS 180		2.5	132	06.01 -	KV6	6	1,1	PFR6N-11	3546		LPG 1
ZT 160 Turbo		1.8		10.02 -	K Series	4	1,1	PFR6N-11	3546		LPG 1
ZT-T 160 Turbo		1.8		10.02 -	K series	4	1,1	PFR6N-11	3546		LPG 1
ZT 120		1.8		07.03 -	K Series	4	1,1	PFR6N-11	3546		LPG 1
ZT CDTi		2.0		07.02 -	M47R (BMW)	4		Y-507J	2691	32	
ZT CDTi		2.0		10.02 -	M47R (BMW)	4		Y-507J	2691	32	
ZT-T CDTi		2.0		07.02 -	M47R (BMW)	4		Y-507J	2691	32	
ZT-T CDTi		2.0		10.02 -	M47R (BMW)	4		Y-507J	2691	32	
ZT 160		2.5	116	06.01 -	KV6	6	1,1	PFR6N-11	3546		LPG 1
ZT 160		2.5	116	06.01 -	KV6	6	1,1	PFR6N-11	3546		LPG 1
ZT-T 160		2.5	116	06.01 -	KV6	6	1,1	PFR6N-11	3546		LPG 1
ZT-T 160		2.5	116	06.01 -	KV6	6	1,1	PFR6N-11	3546		LPG 1
ZT 190		2.5	138	06.01 -	KV6	6	1,1	PFR6N-11	3546		LPG 1
ZT 190		2.5	138	06.01 -	KV6	6	1,1	PFR6N-11	3546		LPG 1
ZT-T 190		2.5	138	06.01 -	KV6	6	1,1	PFR6N-11	3546		LPG 1

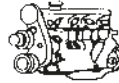

Code *l* kW

Cyl.



Stock-No.



LPG/CNG

**MINI**

Mini D	R50	1.4	55	03.03 -	W17 D14	4	☑	Y-542J	5513	45	
Mini One	R50	1.4	55	09.02 - 12.04	W10 B14	4		BKR6EQUP	3199	30	LPG 1
Mini D	R50	1.4	65	03.03 -	W17 D14	4	☑	Y-542J	5513	45	
Mini One	R50	1.6	66	04.01 -	W10 B16	4		BKR6EQUP	3199	30	LPG 1
Mini Cooper	R50	1.6	85	04.01 -	W10 B16	4		BKR6EQUP	3199	30	LPG 1
Mini Cooper S 16V	R53	1.6	125	12.01 -	W11 B16	4		BKR6EQUP	3199	30	LPG 1
Mini Cooper S 16V JCW	R53	1.6	147	01.03 -	W11 B16	4		BKR7EQUP	4285		
Mini Clubman Cooper S	R55	1.6	120	09.07 - 02.10	N14 B16	4	0,8	PLZKBR7A-G	5843		PLZKBR7A-G
Mini One	R56	1.4	55	03.09 - 03.10	N12 B14A	4	0,8	PLZKBR7A-G	5843		PLZKBR7A-G
Mini One	R56	1.4	70	03.07 -	N12 B14	4	0,8	PLZKBR7A-G	5843		PLZKBR7A-G
Mini One	R56	1.6	55	03.10 -	N16 B16A	4	0,8	PLZKBR7A-G	5843		PLZKBR7A-G
Mini One D	R56	1.6	66	06.09 - 07.10	9HZ (DV6TED4)	4	☑	YE05	91322	73	
Mini One	R56	1.6	72	03.10 -	N16 B16	4	0,8	PLZKBR7A-G	5843		PLZKBR7A-G
Mini Cooper D	R56	1.6	80	03.07 - 09.10	W16 D16	4	☑	YE05	91322	73	
Mini Cooper	R56	1.6	88	09.06 -	N12 B16	4	0,8	PLZKBR7A-G	5843		PLZKBR7A-G
Mini Cooper	R56	1.6	90	03.10 -	N16 B16A	4	0,8	PLZKBR7A-G	5843		PLZKBR7A-G
Mini Cooper S	R56	1.6	128	09.06 -	N14 B16A	4	0,8	PLZKBR7A-G	5843		PLZKBR7A-G
Mini John Cooper Works	R56	1.6	155	05.08 -	N14 B16	4	0,8	ILZKBR7A-8G	5992		ILZKBR7A-8G
Mini John Cooper Works	R56	1.6	160	07.07 -	N14 B16	4	0,8	ILZKBR7A-8G	5992		ILZKBR7A-8G
Mini Coupe Cooper	R58	1.6	85	09.11 -	N16 B16A	4	0,8	PLZKBR7A-G	5843		PLZKBR7A-G
Mini Coupe Cooper	R58	1.6	90	09.11 -	N16 B16A	4	0,8	PLZKBR7A-G	5843		PLZKBR7A-G
Mini Coupe John Cooper Works	R58	1.6	155	09.11 -	N14 B16C	4	0,8	ILZKBR7A-8G	5992		ILZKBR7A-8G
Mini Roadster Cooper	R59	1.6	85	02.12 -	N16 B16A	4	0,8	PLZKBR7A-G	5843		PLZKBR7A-G
Mini Roadster Cooper	R59	1.6	90	02.12 -	N16 B16A	4	0,8	PLZKBR7A-G	5843		PLZKBR7A-G
Mini Roadster John Cooper Works	R59	1.6	155	02.12 -	N14 B16C	4	0,8	ILZKBR7A-8G	5992		ILZKBR7A-8G
Mini Countryman One	R60	1.6	72	06.10 -	N16 B16A	4	0,8	PLZKBR7A-G	5843		PLZKBR7A-G
Mini Countryman Cooper	R60	1.6	85	06.10 -	N16 B16A	4	0,8	PLZKBR7A-G	5843		PLZKBR7A-G
Mini Countryman Cooper	R60	1.6	90	06.10 -	N16 B16A	4	0,8	PLZKBR7A-G	5843		PLZKBR7A-G

**MITSUBISHI**

2000 GTX		2.0		94 -	4G63	4	1,1	BKR5E-11	6953	33	LPG 1
3000 GT		3.0	210	09.92 - 00	6G72/T DOHC	6	1,1	PFR6J-11	2743		PFR6J
3000 GT		3.0		95 - 00	6G72 MPI TC	6	1,1	PFR6J-11	2743		PFR6J
3000 GT		3.0		97 -	6G7	6	1,1	PFR6J-11	2743		PFR6J

**AIRTREK**

Airtrek		2.0	93	02 -	4G63 MPI	4	1,1	BKR6E-11	2756	14	LPG 1
Airtrek		2.0		06.02 -	4G63	4	0,7	PGR6A	4984		PGR7A
Airtrek		2.4		01.03 -	4G64	4	1,1	BKR5E-11	6953	33	LPG 1

**ASX**

ASX 1.6 GA1W		1.6	86	06.10 -	4A92	4	1,1	DILFR5A11	93759		DILFR5A11
ASX 2.0 GA2W		2.0	110	06.10 -	4B11	4	0,8	FR6EI	2687		FR6EI

**CANTER**

Canter (N-FE301, 311, 321, 331)				10.85 - 10.03	4D30	4	☑	Y-971M	5035		
Canter (N-FE401)				10.85 - 10.03	4D30	4	☑	Y-971M	5035		
Canter		3.0	92	09.01 - 02.05	4M42-OAT		☑	Y1007J	3040	59	
Canter		3.0	92	09.01 - 02.05	4M42-OAT		☑	Y1007J	3040	59	

**CARISMA**

Carisma 1.3		1.3	55	09.00 - 10.04	4G13	4	1,1	BKR6E-11	2756	14	LPG 1
Carisma 1600 DAO		1.6	66	07.95 - 99	4G92	4	1,1	BKR6E-11	2756	14	LPG 1
Carisma		1.6		97 - 99	4G92 SOHC	4	1,1	BKR6E-11	2756	14	LPG 1

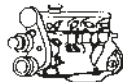
Code *l* kW

Cyl.



Stock-No.



LPG/CNG

## MITSUBISHI CARISMA

Carisma 1800 DAO		1.8	85	09.95 -	4G93	4	1,1	BKR6E-11	2756	14	LPG 1
Carisma GDI		1.8	92	09.97 -	4G93 GDI	4	0,6	IZFR6B	3116		IZFR6B
Carisma Elegance GDI		1.8	92	99 -	4G93 GDI	4	0,6	IZFR6B	3116		IZFR6B
Carisma 1800 DAO		1.8	103	09.95 -	4G93	4	1,1	BKR6E-11	2756	14	LPG 1
Carisma		1.8		97 - 00	4G93 SOHC	4	1,1	BKR6E-11	2756	14	LPG 1
Carisma TD		1.9	66	10.96 -	F8Q	4	█	Y-933J	7947	25	
Carisma 1.9 DI-D(DA..)		1.9	75	09.00 -		4	█	Y-732J	5605	4	
Carisma 1.9 DI-D(DA..)		1.9	85	09.00 -		4	█	Y-732J	5605	4	

## COLT

Colt 1600 (2)		1.6		- 92		4	0,8	BPR6ES	7822	2	LPG 2
Colt 1300 (3)		1.3		89 - 92	4G13	4	1,1	BPR6ES-11	4824	13	LPG 2
Colt 1500 (3)		1.5		- 12.93	4G15	4	0,8	BPR6ES	7822	2	LPG 2
Colt 1500 (3)		1.5		91 -	4G15 Cat.	4	1,1	BPR6ES-11	4824	13	LPG 2
Colt 1800 (3)		1.8			4G67 Cat.	4	0,8	BPR7ES	2023	19	BPR8EIX
Colt 1300 (4)		1.3	55	93 - 94	4G13 / MPI Cat.	4	1,1	BPR6ES-11	4824	13	LPG 2
Colt 1300 (4)		1.3		92 -	4G13 / MPI	4	1,1	BPR5ES-11	4424		LPG 2
Colt 1300 (4)		1.3		95 -	4G13	4	1,1	BPR5ES-11	4424		LPG 2
Colt 1500 (4)		1.5	69	94 -	4G15	4	0,8	BP5ES	6511	8	LPG 2
Colt 1600 16V (4)		1.6	83	12.91 -	4G92	4	0,8	BPR6ES	7822	2	LPG 2
Colt 1600 (4)		1.6	83	94 - 95	4G92 MPI	4	1,1	BKR6E-11	2756	14	LPG 1
Colt 1600 (4)		1.6		92 - 93	4G92	4	1,1	BKR6E-11	2756	14	LPG 1
Colt 1600 (4)		1.6		95 - 96	4G92 MPI MVV	4	1,1	BKR6E-11	2756	14	LPG 1
Colt 1800 GTI 16V (4)		1.8	103	94 -	4G93 MPI	4	1,1	BKR6E-11	2756	14	LPG 1
Colt 1300 (5)		1.3	55	03.96 -	4G13	4	1,1	BPR5ES-11	4424		LPG 2
Colt 1300 (5)		1.3	60	09.00 -		4	1,1	BKR6E-11	2756	14	LPG 1
Colt 1300 (5)		1.3		97 -	4G13	4	1,1	BPR5ES-11	4424		LPG 2
Colt (5)		1.6	66	03.96 - 03	4G92	4	1,1	BKR6E-11	2756	14	LPG 1
Colt 1600 (5)		1.6	66	03.96 -	4G92	4	1,1	BKR6E-11	2756	14	LPG 1
Colt 1600 (5)		1.6		97 -	4G9 MVV	4	1,1	BKR6E-11	2756	14	LPG 1
Colt 1600 (5)		1.6		97 -	4G9(not MVV Magermix)	4	1,1	BKR6E-11	2756	14	LPG 1
Colt (6) Z31A / Z32A		1.1	55	04.05 -	3A91 12V	3	1,1	LFR6C-11	5788		
Colt (6) Z33A / Z34A		1.3	70	04.05 - 06.10	4A90 16V	4	1,1	LFR6C-11	5788		
Colt DID (6) Z38A		1.5	50	04.05 - 09.08	639 938	3	█	YE13	8643		
Colt DID (6) Z39A		1.5	70	04.05 - 09.08	639 939	3	█	YE13	8643		
Colt (6) Z36A		1.5	80	04.05 -	4A91 16V	4	0,8	ILZFR6C-K	6645		ILZFR6C-K
Colt CZC (6) Z36A		1.5	80	04.05 - 07.08	4A91 16V	4	0,8	ILZFR6C-K	6645		ILZFR6C-K
Colt CZC (6) Z37A		1.5	110	03.05 - 07.08	4G15T DOHC	4	0,8	ILZFR6C-K	6645		ILZFR6C-K
Colt CZT (6) Z37A		1.5	110	03.05 -	4G15T DOHC	4	0,8	ILZFR6C-K	6645		ILZFR6C-K

## DIAMANTE

Diamante (F31A, F41A) 2500 GDI		2.5		09.99 - 09.01	6G73		0,8	IZFR5C	7748		IZFR5C
Diamante 3000		3.0		94 -	6G72 MPI DOHC	6	0,8	BK6E	3536		LPG 1
Diamante 3000		3.0		94 -	6G72 MPI SOHC	6	1,1	BPR6ES-11	4824	13	LPG 2
Diamante (F36A, F46A) 3000 GDI		3.0		09.99 - 09.01	6G72	6	0,8	IZFR5C	7748		IZFR5C

## ECLIPSE

Eclipse 2000 D30		2.0	107	11.95 - 04.99	4G63	4	1,1	BPR6ES-11	4824	13	LPG 2
Eclipse 2000		2.0	110	91 - 10.95	4G63 MPI DOHC	4	0,8	BPR7ES	2023	19	BPR8EIX
Eclipse		2.0		97 -	4G6	4	1,1	BPR6ES-11	4824	13	LPG 2
Eclipse 2400		2.4	105	09.98 - 04.99	4G64	4	1,1	BKR5E-11	6953	33	LPG 1
Eclipse V6 24V		3.0	147	07.03 -	4G72 SOHC MPI	6	0,8	FR6EI	2687		FR6EI

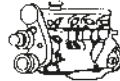
Code *l* kW

Cyl.



Stock-No.

V-TIME

LPG/CNG

**MITSUBISHI****ETERNA**

Eterna 2000 (E74A,E84A)		2.0		05.92 - 10.94	6A12	4	0,8	PFR6J	2645		PFR6J
Eterna 2500 (EC5A)		2.5		08.96 -	6A13	4	0,8	PFR6J	2645		PFR6J

**EVOLUTION**

Evolution-V	CP9A	2.0	206		4G63 Turbo	4	0,8	PGR7A	3200		PGR7A
Evolution-VI	CP9A	2.0	206	02.98 - 05.99	4G63 Turbo	4	0,8	PGR7A	3200		PGR7A
Evolution-VI Tommi Makinen Edit.	CP9A	2.0	250	01.99 -	4G63 Turbo	4	0,8	IGR7A	6687		IGR7A
Evolution-VII	CT9A	2.0	206	01 -	4G63 Turbo	4	0,8	IGR7A-G	3106		IGR7A-G
Evolution-VIII	CT9A	2.0	195	04 -	4G63 Turbo	4	0,8	IGR7A-G	3106		IGR7A-G
Evolution-IX	CT9A	2.0	195	03.05 -	4G63 Turbo	4	0,6	ILFR7H	5245		ILFR7H
					D4(VVT)DOHC						
Evolution-X		2.0	217	04.08 - 09.10	4B11 FQ30	4	0,6	ILKR8E6	1422		
Evolution-X		2.0	217	10.10 -	4B11 FQ30	4	0,6	DILKR8B6	91448		

**GALANT**

Galant 1800		1.8	85	93 - 94	4G93 MPI	4	1,1	BKR6E-11	2756	14	LPG 1
Galant 1800		1.8		90 - 91	4G37 Cat.	4	1,1	BPR6ES-11	4824	13	LPG 2
Galant 1800		1.8		92 - 96	4G37 Cat.	4	1,1	BPR7ES-11	7226		BPR8EIX
Galant 1800		1.8		94 - 96	4G93	4	0,8	BK6E	3536		LPG 1
Galant TD (E5..8)		2.0	66	11.92 - 10.96	4D68 SOHC	4	█	CY57	4994	21	
Galant TD (EA)		2.0	66	10.96 - 02.00	4D68	4	█	CY57	4994	21	
Galant 2000		2.0	100	96 - 03	4G63	4	1,1	BKR6E-11	2756	14	LPG 1
Galant 2000		2.0	101	94 - 03	4G63 MPI	4	1,1	BKR6E-11	2756	14	LPG 1
Galant 2000 V6 (E74A,E84A)		2.0	110	05.92 - 10.94	6A12 MPI 24V	6	1,1	PFR6J-11	2743		PFR6J
Galant		2.0		88 - 93	4G63 GTi16	4	0,8	BPR7ES	2023	19	BPR8EIX
Galant		2.0		91 - 91	4G63	4	0,8	BPR6ES	7822	2	LPG 2
Galant 2000		2.0		92 -	Cat.	4	1,1	BPR7ES-11	7226		BPR8EIX
Galant 2000		2.0		92 - 92	4G63	4	1,1	BPR7ES-11	7226		BPR8EIX
Galant 2000		2.0		92 - 92	4G63D	4	0,8	BPR6ES	7822	2	LPG 2
Galant 2000		2.0		93 - 96	4G63	4	0,8	BK6E	3536		LPG 1
Galant		2.0		97 - 03	4G63	4	1,1	BKR6E-11	2756	14	LPG 1
Galant GDI		2.4	110	10.98 -	4G64 GDI	6	0,6	IZFR5B	4080		IZFR6B
Galant 2400		2.4		94 -	4G64 MPI DOHC	6	1,1	BPR6ES-11	4824	13	LPG 2
Galant 2400		2.4		94 -	4G64 MPI SOHC	6	1,1	BKR6E-11	2756	14	LPG 1
Galant 2500 V6		2.5	125	93 - 03.97	6G12 24V	6	1,1	PFR6J-11	2743		PFR6J
Galant V6 24V		2.5		95 - 00	6G73 MPI	6	1,1	PFR6J-11	2743		PFR6J
Galant 2500 (EC5A)		2.5		08.96 - 03	6A13	4	0,8	PFR6J	2645		PFR6J
Galant V6		2.5		03.97 - 03	6A13	6	1,1	PFR6G-11	5555		PFR7G
Galant Wagon TD (EA)		2.0	66	10.96 - 02.00	4D68	4	█	CY57	4994	21	

**GALLOPER**

Galloper Td		2.5	65	02.99 - 01	D4BH	4	█	CY57	4994	21	
Galloper Td		2.5	73	02.99 - 01	D4BH	4	█	CY57	4994	21	
Galloper		3.0	104	98 - 12.01	G6AT	6	1,1	BPR5ES-11	4424		LPG 2

**GRANDIS**

Grandis 2.0 DI-D ohne Partikelfilter		2.0	100	09.05 - 03.10	BSY (VW engine)	4	█	YE14	7768	48	
Grandis 2.0 DI-D mit Partikelfilter		2.0	100	06.07 - 03.10	BSY (VW engine)	4	█	CZ304	9864	55	
Grandis 2.0 DI-D ohne Partikelfilter		2.0	103	02.07 - 03.10	BWC	4	█	YE14	7768	48	
Grandis 2.0 DI-D mit Partikelfilter		2.0	103	06.07 - 03.10	BWC	4	█	CZ304	9864	55	
Grandis 2.4		2.4	121	04.04 -	4G69	4		LZFR6AI	3656		LZFR6AI

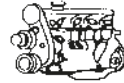
Code *l* kW

Cyl.



Stock-No.



LPG/CNG

**MITSUBISHI****I**

i 0.7	HA1W	0.66	38	02.07 -	3B20	3	0,8	ILKR7B8	1989		
<b>L200</b>											
L200		1.6			4G32 Cat.	4	0,8	BPR6ES	7822	2	LPG 2
L200		1.6		92 -	4G32	4	0,9	BPR5ES	7422	6	LPG 2
L200		2.0		- 92	4G63	4	0,8	BPR7ES	2023	19	BPR8EIX
L200		2.0		92 -	4G63	4	0,8	BPR6ES	7822	2	LPG 2
L200		2.4	82	94 -	4G64 MPI	4	1,1	BCPR6ES-11	7121	11	LPG 3
L200		2.4	97	99 -		4	1,1	BPR6ES-11	4824	13	LPG 2
L200 (KOT-K3T) ohne Schnellstartanlage		2.5	51	11.93 - 05.94	4D56 without QGS	4	☑	Y-733J	6592	13	
L200 (KOT-K3T)		2.5	51	06.94 - 08.96	4D56 SOHC	4	☑	CY57	4994	21	
L200		2.5		- 93	4D55	4	☑	Y-115T1	2189		
L200		2.5		99 -	4D56	4	☑	Y-733J	6592	13	
L200		2.6	76	93 -	4G54/B	4	1,1	BPR6ES-11	4824	13	LPG 2
L200		2.6		- 92	4G54	4	1,1	BPR6ES-11	4824	13	LPG 2
L200		2.6		95 -	G54B	4	1,1	BUR6EA-11	5428		
L200 2.5 DI-D	KB4T	2.5	94	04.10 -	4D56HP	4	☑	CZ251	91238	76	
L200 2.5 DI-D	KB4T	2.5	100	11.05 -	4D56HP	4	☑	CZ251	91238	76	
L200 2.5 DI-D Euro III + IV	KB4T	2.5	123	08.07 -	4D56HP	4	☑	CZ251	91238	76	
L200 2.5 DI-D	KB4T	2.5	131	06.09 -	4D56HP	4	☑	CZ251	91238	76	

**L300**

L300		1.4		94 -	4G33	4	0,7	BP6ES	7811	4	LPG 2
L300		2.0	66	92 -	4G63 Cat.	4	0,8	BPR6ES	7822	2	LPG 2
L300		2.0	85	07.94 -	4G63	4	0,9	BPR5ES	7422	6	LPG 2
L300		2.0		- 92	4G63	4	0,8	BPR6ES	7822	2	LPG 2
L300		2.0		10.94 -	4G63 MPI	4	1,1	BKR5E-11	6953	33	LPG 1
L300		2.0		95 -	4G63 FBC	4	1,1	BKR5E-11	6953	33	LPG 1
L300		2.4	82	92 -	4G64 Cat.	4	1,1	PGR6A-11	3738		PGR7A
L300 TD (P)		2.5	64	06.93 - 96	4D56 SOHC	4	☑	CY57	4994	21	
L300		2.5		- 92	4D5	4	☑	Y-115T1	2189		
L300		2.5		97 -	4D56	4	☑	Y-733J	6592	13	
L300 / 4WD QGS Type		2.3			4D55	4	☑	Y-115R1	2161		

**L400**

L400				95 - 97	4D56	4	☑	CY57	4994	21	
L400		2.0		95 -	4G63 MPI	4	1,1	BKR5E-11	6953	33	LPG 1
L400		2.4		95 -	4G64 MPI	4	1,1	BKR5E-11	6953	33	LPG 1
L400 TD		2.5	73	12.94 -	4D56	4	☑	CY57	4994	21	
L400		2.5		98 -	4D56	4	☑	Y-733J	6592	13	

**LANCER**

Lancer 1300		1.3	55	10.92 - 01	4G13 MPI	4	1,1	BPR5ES-11	4424		LPG 2
Lancer		1.3	55	03.96 - 01	4G13	4	1,1	BUR6EA-11	5428		
Lancer 1.3	CS1A	1.3	60	09.03 - 06.06	4G13S	4	1,1	BKR6E-11	2756	14	LPG 1
Lancer 1.3	CS1A	1.3	60	07.06 -	4G13S	4	0,8	IFR6S	99404		
Lancer 1300		1.3		- 09.92	4G13 Cat.	4	0,8	BPR6ES	7822	2	LPG 2
Lancer 1300		1.3		89 - 92	4G13	4	0,8	BPR6ES	7822	2	LPG 2
Lancer 1300		1.3		10.92 - 01	4G13	4	0,8	BP5ES	6511	8	LPG 2
Lancer 1300		1.3		97 -	4G1	4	1,1	BPR5ES-11	4424		LPG 2
Lancer 1500		1.5	69	93 - 00	4G15	4	0,8	BP5ES	6511	8	LPG 2
Lancer Sportback 1.5	CX2A	1.5	80	06.08 -	4A91 MIVEC	4	1,1	ILZFR6C-11K	4673		ILZFR6C-11K
Lancer Stufenheck 1.5	CX2A	1.5	80	06.08 -	4A91 MIVEC	4	1,1	ILZFR6C-11K	4673		ILZFR6C-11K
Lancer 1500		1.5		08.84 - 92	4G15	4	0,8	BPR6ES	7822	2	LPG 2
Lancer 1500		1.5		86 - 92	4G15 Cat.	4	1,1	BPR6ES-11	4824	13	LPG 2

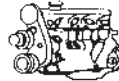
Code *l* kW

Cyl.

Stock-No.  
**VEFINE**  
E-PROMPTER

LPG/CNG

**MITSUBISHI****LANCER**

Lancer 1500		1.5		94 - 96	4G91 MPI	4	1,1	BK6E-11	7340		LPG 1
Lancer 1.6	CS3A/CS3W	1.6	72	09.03 - 06.06	4G18	4	1,1	BKR6E-11	2756	14	LPG 1
Lancer 1.6	CS3A/CS3W	1.6	72	07.06 -	4G18	4	0,8	IFR6S	99404		
Lancer 1600		1.6	83	10.92 - 00	4G92 MPI	4	1,1	BKR6E-11	2756	14	LPG 1
Lancer 1.6	CY1A / CX1A	1.6	86	05.10 -	4A92	4	1,1	DILFR5A11	93759		DILFR5A11
Lancer 1600 Twin Carb.		1.6				4	0,8	BPR6ES	7822	2	LPG 2
Lancer 1600		1.6		90 - 09.92	4G61 DOHC	4	0,8	BPR6ES	7822	2	LPG 2
Lancer 1600		1.6		94 - 12.96	4G92 MVV	4	1,1	BKR5E-11	6953	33	LPG 1
Lancer 1600		1.6		97 -	4G9 MVV	4	1,1	BKR5E-11	6953	33	LPG 1
Lancer 1600		1.6		97 - 00	4G9 (not MVV Magermix)	4	1,1	BKR6E-11	2756	14	LPG 1
Lancer Sportback 1.8	CX3A	1.8	105	06.08 -	4B10 MIVEC	4	0,8	FR6EI	2687		FR6EI
Lancer Stufenheck 1.8	CY3A	1.8	105	02.08 - 03.09	4B10 MIVEC	4	0,8	FR6EI	2687		FR6EI
Lancer Stufenheck 1.8	CY3A	1.8	105	04.09 -	4B10 MIVEC	4	1,1	DIFR5C11	1311		DIFR5C11
Lancer 1800		1.8		86 - 92	4G37 Cat.	4	1,1	BPR6ES-11	4824	13	LPG 2
Lancer 1800		1.8		86 - 92	4G67	4	0,8	BPR7ES	2023	19	BPR8EIX
Lancer		1.8		90 - 92	4G37 GLXi	4	1,1	BPR6ES-11	4824	13	LPG 2
Lancer		1.8		90 - 92	4G37 GTi16	4	0,8	BPR6ES	7822	2	LPG 2
Lancer		1.8		93 -	4G93 GTi16	4	1,1	BKR6E-11	2756	14	LPG 1
Lancer 1800 16V		1.8		93 -	4G93 MPI	4	0,8	BK6E	3536		LPG 1
Lancer (CB/CD)		2.0	50	12.93 - 06.96	4D68	4	☑	CY57	4994	21	
Lancer		2.0	99	09.03 -	4G63	4	1,1	IGR6A11	5743		IGR6A11
Lancer 2000		2.0		01.05 -	4G94	4	1,1	BKR5E-11	6953	33	LPG 1

**MIRAGE**

Mirage		1.5		94 -	4G15 MPI	4	1,1	BPR5ES-11	4424		LPG 2
Mirage		1.6		96 -	4G92	4	1,1	BKR6E-11	2756	14	LPG 1
Mirage		1.8		94 -	4G93 MPI	4	1,1	BKR5E-11	6953	33	LPG 1

**MONTERO**

Montero				92 - 93	4D56	4	☑	Y-115T1	2189		
Montero				94 - 95	4D56	4	☑	CY57	4994	21	
Montero				96 -	4D56	4	☑	Y-733J	6592	13	
Montero Sport				97 -		4	☑	Y-733J	6592	13	
Montero V6 3000		3.0		91 -	6G72	6	1,1	BPR5ES-11	4424		LPG 2

**OUTLANDER**

Outlander 2.0		2.0	93	05.03 -		4	1,1	IGR6A11	5743		IGR6A11
Outlander 2.0		2.0	100	05.03 -	4G63	4	1,1	IGR6A11	5743		IGR6A11
Outlander 2.0 DI-D		2.0	103	11.06 - 06.10	BSY	4	☑	CZ304	9864	55	
Outlander 2.0 (CW4W)	CW4W	2.0	108	06.09 -	4B11	4	1,1	DIFR6C11	1312		
Outlander 2.0 Turbo		2.0	148	05 -	4G63 Turbo Mpi	4	1,1	IGR6A11	5743		IGR6A11
Outlander 2.0		2.0	177	05.03 -		4	1,1	IGR6A11	5743		IGR6A11
Outlander 2.2 DI-D		2.2	115		4HK / 4HN	4	☑	YE08	4966		
Outlander 2.4		2.4	102	05.03 -		4		LZFR6AI	3656		LZFR6AI
Outlander 2.4		2.4	118	05.03 -	4G69	4		LZFR6AI	3656		LZFR6AI
Outlander 2.4	CW5W	2.4	125	06.07 -	4B12	4	0,8	FR5EI	1313		FR6EI
Outlander 3.0	CW6W	3.0	162	11.06 -	6B31	6	0,8	ILKR7B8	1989		

**PAJERO**

Pajero					4D56 S-QGS Type	4		—onley OE			
Pajero				85 -	4D55T	4		—onley OE			
Pajero				92 - 93	4D56	4	☑	Y-115T1	2189		
Pajero Sport				97 -	4D56-QGS	4		—onley OE			
Pajero 2400		2.4		03.91 -	4G64	4	1,1	BPR6ES-11	4824	13	LPG 2

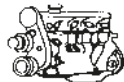

Code *ℓ* kW

Cyl.



Stock-No.



LPG/CNG

## MITSUBISHI PAJERO

Pajero		2.4		97 -	4G64	4	1,1	BPR6ES-11	4824	13	LPG 2
Pajero TD not QGS Type		2.5	62	06.86 -	4D56 Turbo not QGS Type	4	1,1	Y-115T1	2189		
Pajero TD Intercooler (IV)		2.5	62	08.93 - 05.99	4D56 T	4	1,1	Y-733J	6592	13	
Pajero TD Intercooler (V)		2.5	73	11.93 - 01.98	4D56 T	4	1,1	CY57	4994	21	
Pajero 2600		2.6			4G54	4	0,9	BPR5ES	7422	6	LPG 2
Pajero 2600		2.6			4G54 Cat.	4	1,1	BPR5ES-11	4424		LPG 2
Pajero 2600		2.6		92 -		4	1,1	BP6ES-11	1212		LPG 2
Pajero (V4..)		2.8	92	06.94 - 04.00	4M40	4	1,1	CY55	3861		
Pajero		3.0	130	97 -	6G72 24Ventiler	6	1,1	PFR6J-11	2743		PFR6J
Pajero 3000 V6		3.0		89 -	6G72	6	1,1	BPR5ES-11	4424		LPG 2
Pajero		3.0		97 -	6G72 12Ventiler	6	1,1	BPR5ES-11	4424		LPG 2
Pajero Sport		3.0		99 -	6G72 24Ventiler	6	1,1	PFR6J-11	2743		PFR6J
Pajero 3.2 DI-D		3.2	118	04.00 -		4	1,1	Y-532J	7782		
Pajero		3.5	143	97 -	6G74	6	1,1	PFR5J-11	4642		PFR5J-11
Pajero GDI V60		3.5	149	04.00 -	V6	6	0,6	IZFR5B	4080		IZFR6B
Pajero 3500 V6		3.5	153	04.94 - 97	6G74 DOHC	6	1,1	PFR6J-11	2743		PFR6J
Pajero 3.2 DI-D	V88W/V98W	3.2	118	02.07 -	4M41	6	1,1	CZ251	91238	76	
Pajero 3.2 DI-D	V88W/V98W	3.2	125	02.07 -	4M41	6	1,1	CZ251	91238	76	
Pajero 3.2 DI-D	V88W/V98W	3.2	147	01.09 -	4M41	6	1,1	CZ251	91238	76	
Pajero 3.8 V6 GDI	V87W/V97W	3.8	182	02.10 -	6G75	6		IFR6B-K	4867		IFR6B-K
Pajero 3.8 V6 GDI	V87W/V97W	3.8	184	11.06 -	6G75	6		IFR6B-K	4867		IFR6B-K
Pajero Classic		3.2	118	05.05 -	4M41			Y1007J	3040	59	
Pajero III		3.2	118	10.01 -	4M41			Y1007J	3040	59	
Pajero III		3.2	121	04.00 - 10.01	4M41			Y1007J	3040	59	

## PAJERO PININ

Pajero Pinin 1.8	H66W/H76W	1.8	88	00 -	4G93 GDI	4	0,6	IZFR6B	3116		IZFR6B
Pajero Pinin 2.0	H66W/H76W	2.0	95	09.00 -	4G94 GDI	4	0,6	IZFR5B	4080		IZFR6B

## SANTAMO

Santamo		2.0	102	99 -	DOHC / SOHC	4	1,1	BP6ES-11	1212		LPG 2
---------	--	-----	-----	------	-------------	---	-----	----------	------	--	-------

## SHOGUN

Shogun		2.5		94 - 95	4D56	4	1,1	CY57*	4994	21	
Shogun		2.5		01.96 - 03.00	4D56	4	1,1	Y-733J	6592	13	
Shogun		3.0		91 - 94	6G72	6	1,1	BPR5ES-11	4424		LPG 2
Shogun		3.0		91 - 94	6G72	6	1,1	BPR5ES-11	4424		LPG 2
Shogun		3.0		94 -	6G72	6	1,1	PFR6J-11	2743		
Shogun		3.5		91 -	6G74	6	1,1	PFR5J-11	4642		
Shogun		3.5		00 -		6	0,8	IZFR5B	4080		IZFR6B
Shogun PININ		1.8		00 -	4G93 GDI	4	0,8	IZFR6B	3116		IZFR6B
Shogun PININ		2.0		00 -	4G94 GDI	4	0,8	IZFR5B	4080		IZFR6B

## SIGMA

Sigma V6		3.0		91 - 93	6G72 DOHC 24V	6	1,1	PFR6J-11	2743		PFR6J
Sigma V6		3.0		91 - 93	6G72 SOHC	6	1,1	BPR6ES-11	4824	13	LPG 2
Sigma 3000		3.0		93 - 96	6G72 MPI V6	6	1,1	BPR6ES-11	4824	13	LPG 2
Sigma 3000		3.0		94 - 96	6G72 MPI V6-24V	6	1,1	PFR6J-11	2743		PFR6J

## SPACE GEAR

Space Gear		2.0	83	04.95 - 01	4G63 MPI	4	1,1	BKR5E-11	6953	33	LPG 1
Space Gear		2.0		97 - 01	4G69	4	1,1	BKR5E-11	6953	33	LPG 1
Space Gear		2.4	97	04.95 - 01	4G64 MPI	4	1,1	BKR5E-11	6953	33	LPG 1

Code *l* kW

Cyl.



Stock-No.

V-TIME

LPG/CNG

**MITSUBISHI****SPACE GEAR**

Space Gear		2.5	73	12.94 -	4D56	4		CY57	4994	21	
Space Gear		2.5	73	06.94 - 05.95	4D56 Turbo	4		Y-733J	6592	13	
Space Gear		2.5		98 -	4D56 Turbo	4		Y-733J	6592	13	

**SPACE RUNNER**

Space Runner 1800		1.8	90	09.91 - 92	4G93	4	1,1	BKR6E-11	2756	14	LPG 1
Space Runner 1800		1.8	90	91 - 99	4G93 MPI	4	1,1	BKR6E-11	2756	14	LPG 1
Space Runner 1800		1.8		94 - 99	4G93	4	0,8	BK6E	3536		LPG 1
Space Runner		1.8		97 - 99	4G93	4	1,1	BKR6E-11	2756	14	LPG 1
Space Runner		2.0	60	06.93 -	4D68	4		CY57	4994	21	
Space Runner		2.0	100	99 - 08.02	4G63 MPI	4	1,1	BKR6E-11	2756	14	LPG 1
Space Runner GDI		2.4	110	99 -	4G64 GDI	4	0,6	IZFR5B	4080		IZFR6B

**SPACE STAR**

Space Star 1.3		1.3	63	12.98 - 05.00	4G13	4	1,1	BKR5E-11	6953	33	LPG 1
Space Star 1.3		1.3	63	06.00 - 12.04	4G13	4	1,1	BKR6E-11	2756	14	LPG 1
Space Star 1.6		1.6	72	04.01 - 12.04	4G18	4	1,1	BKR6E-11	2756	14	LPG 1
Space Star 1.8 MPI		1.8	82	08.02 - 12.04	4G93	4	0,6	IZFR6B	3116		IZFR6B
Space Star 1.8 GDI		1.8	87	06.98 - 12.04	4G93 GDI	4	0,6	IZFR6B	3116		IZFR6B
Space Star 1.8 GDI		1.8	90	06.98 - 12.04	4G93 GDI	4	0,6	IZFR6B	3116		IZFR6B
Space Star 1.9 DI-D		1.9	75	08.00 - 12.04	F9Q1	4		Y-732J	5605	4	
Space Star 1.9 DI-D		1.9	85	08.02 - 12.04	F9Q2	4		Y-732J	5605	4	

**SPACE WAGON**

Space Wagon 1800		1.8		09.91 - 93	4G93	4	1,1	BKR6E-11	2756	14	LPG 1
Space Wagon 1800		1.8		94 -	4G93	4	0,8	BK6E	3536		LPG 1
Space Wagon 1800		1.8		94 -	4G93 MPI	4	1,1	BKR6E-11	2756	14	LPG 1
Space Wagon (N)		2.0	60	06.93 - 11.00	4D68	4		CY57	4994	21	
Space Wagon 2000		2.0	98	92 - 00	4G63 MPI Cat.	4	1,1	BKR6E-11	2756	14	LPG 1
Space Wagon Gdi (N5.)		2.0	98	02.02 -	4G94	4	1,1	HB6BIX-11P	5705		HB6BIX-11P
Space Wagon		2.0		97 -	4G63	4	1,1	BKR5E-11	6953	33	LPG 1
Space Wagon GDI	N84W/N94W	2.4	110	10.98 - 01.04	4G64 GDI	4	0,6	IZFR5B	4080		IZFR6B
Space Wagon 2400		2.4		93 - 95	4G64 Cat.	4	1,1	BKR6E-11	2756	14	LPG 1

**STARION**

Starion 2000		2.0				4	0,8	BPR7ES	2023	19	BPR8EIX
--------------	--	-----	--	--	--	---	-----	--------	------	----	---------

**MORGAN**

4/4		1.6	71	01.82 - 93	CVH Ford	4	0,8	BCPR6ES	2330	12	LPG 3
4/4		1.6	72	01.82 -	132D.000	4	0,7	BP6ES	7811	4	LPG 2
4/4		1.8	89	02.93 -	Zetec 16V	4	1,3	PTR5A-13	2467	25	LPG 4
4/4		1.8		94 - 98	FORD ZETEC	4	1,0	PTR5A-10	5055		
Aero 8		4.4	210	00 -	BMW M62B44	8		BKR6EQUIP	3199	30	LPG 1
Plus 4		2.0	98	09.87 - 92	M16i	4	0,8	BCPR6ES	2330	12	LPG 3
Plus 4		2.0	99	09.92 - 96	T16	4	0,8	BCPR6ES	2330	12	LPG 3
Plus 8		3.5	136	01.90 - 01	V8 Rover Cat.	8	0,7	BP6ES	7811	4	LPG 2
Plus 8		3.5	142	01.90 - 01	V8 Rover	8	0,7	BP6ES	7811	4	LPG 2
Plus 8		3.9	140	01.90 - 09.03	V8 Kat Rover	8	0,8	BPR6ES	7822	2	LPG 2
Plus 8		4.0		01 -	ROVER V8	8	1,1	PFR6N-11	3546		LPG 1
Plus 8		4.6		97 - 99	ROVER V8	8	1,1	PFR6N-11	3546		LPG 1

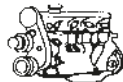
Code *l* kW

Cyl.



Stock-No.



LPG/CNG

**NISSAN  
100 NX**

100 NX	B13	1.6	66	10.90 - 95	GA16DE	Cat.	4	0,9	BKR6E	6962	28	LPG 1
100 NX	B13	1.6	66	10.90 - 93	GA16DS	Cat.	4	0,9	BKR6E	6962	28	LPG 1
100 NX	B13	1.6	75	09.93 - 94	GA16DE		4	0,8	BKR5E	7938	35	LPG 1
100 NX	B13	2.0	105	10.90 - 95	SR20DE	Cat.	4	0,9	BKR6EY	3696		LPG 1

**200 SX**

200 SX Turbo	S13	1.8	124	89 - 93	CA18DET		4	1,1	PFR6A-11	4045		PFR6A-11
200 SX Turbo	S13	1.8	124	09.88 - 93	CA18DET	Cat.	4	1,1	PFR6A-11	4045		PFR6A-11
200 SX Turbo	S13	1.8	129	09.88 - 93	CA18DET		4	1,1	BCPR6ES-11	7121	11	LPG 3
200 SX Turbo	S14	2.0	147	08.94 - 12.99	SR20DET		4	0,9	PFR6B-9	3100		PFR7B

**300 ZX**

300 ZX	Z32	3.0		90 - 96	VG30DE		6	1,1	PFR6B-11	4014		PFR7B
300 ZXTT Biturbo	Z32	3.0	197	90 - 95	VG30DETT		6	1,1	PFR6B-11C	2684		
300 ZX Biturbo	Z32	3.0	206	01.90 - 95	VG30DETT	Cat.	6	1,1	PFR6B-11C	2684		

**350 Z**

350 Z	Z33	3.5	206	10.03 - 06.06	VQ35DE		6	1,1	PLFR5A-11	6240		LPG 7
350 Z	Z33	3.5	221	04.06 - 01.07	VQ35DE		6	1,1	PLFR5A-11	6240		LPG 7
350 Z	Z33	3.5	230	09.05 -	VQ35HR		6	1,1	DF7H-11B	1317		

**370 Z**

370 Z	Z34	3.7	241	06.09 -	VQ37VHR		6	1,1	DF8H-11B	1305		
370 Z	Z34	3.7	243	06.09 -	VQ37VHR		6	1,1	DF8H-11B	1305		

**ALMERA 1**

Almera 1.4	N15	1.4	55	09.95 - 04.00	GA14DE		4	0,8	BKR5E	7938	35	LPG 1
Almera 1.6	N15	1.6	66	09.95 -	GA16DE		4	0,8	BKR5E	7938	35	LPG 1
Almera 1.6	N15	1.6	66	95 - 00	QG15DE		4	1,1	BKR5E-11	6953	33	LPG 1
Almera 2.0 D	N15	2.0	55	07.95 - 00	CD20E		4	█	CY52	3017		
Almera 2.0 Gti	N15	2.0	105	95 - 04.00	SR20DE		4	1,1	BKR5EY-11	2355		LPG 1

**ALMERA 2**

Almera 1.5 dCi	N16	1.5	60	01.03 -	K9K		4	█	Y-732J	5605	4	
Almera 1.5	N16	1.5	66	02.00 - 09.02	QG15DE		4	1,1	BKR5E-11	6953	33	LPG 1
Almera 1.5	N16	1.5	72	10.02 -	QG15DE		4	1,1	LFR5A-11	6376		LPG 7
Almera 1.8	N16	1.8	84	02.00 - 09.02	QG18DE		4	1,1	BKR5E-11	6953	33	LPG 1
Almera 1.8	N16	1.8	85	10.02 -	QG18DE		4	1,1	LFR5A-11	6376		LPG 7
Almera 2.2 dCi	N16	2.2	82	09.03 -	YD22DDTi		4	█	Y-519J	93293	61	
Almera 2.2 dCi	N16	2.2	100	09.03 -	YD22DDTi		4	█	Y-519J	93293	61	

**ALMERA TINO**

Almera Tino 1.8	V10	1.8	84	00 - 02	QG18DE		4	1,1	BKR5E-11	6953	33	LPG 1
Almera Tino 1.8	V10	1.8	85	03 -	QG18DE		4	1,1	LFR5A-11	6376		LPG 7
Almera Tino 2.0	V10	2.0	100	00 - 02	SR20DE		4	1,1	PFR6G-11	5555		PFR7G
Almera Tino 2.2 dCi	V10	2.2	82	09.03 -	YD22DDTi		4	█	Y-519J	93293	61	
Almera Tino 2.2 dCi	V10	2.2	100	09.03 -	YD22DDTi		4	█	Y-519J	93293	61	

**BLUEBIRD**

Bluebird 1.8		1.8		90 -	CA18NS		4	0,8	BCP5ES	7496	16	LPG 3
Bluebird 1.8		1.8		90 -	CA18S		4	0,8	BCP5ES	7496	16	LPG 3
Bluebird 1.6	U13	1.6		94 -	CA16NS		4	0,8	BCP5ES	7496	16	LPG 3
Bluebird 2.0	U13	2.0		93 -	CA20E		4	1,1	BCPR6ES-11	7121	11	LPG 3
Bluebird 2.0	U13	2.0		93 -	CA20S		4	0,7	BCP6ES	4930	17	LPG 3

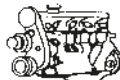
Code *l* kW

Cyl.



Stock-No.

**NISSAN****CABSTER**

Cabster 1.6	F23 / H41	1.6		93 -	Z16	4	0,8	BP5ES	6511	8	LPG 2
Cabster 2.0	F23 / H41	2.0		93 -	Z20	4	0,8	BP5ES	6511	8	LPG 2
Cabster 2.4	F23 / H41	2.4		93 -	Z24	6	0,7	BP6ES	7811	4	LPG 2

**CARAVAN**

Caravan 2.0		2.0	120	01.01 -	KA20DE (DOHC)	4	1,1	BKR5E-11	6953	33	LPG 1
Caravan 2.4		2.4		01.01 -	KA24DE (DOHC)	4	1,1	BKR5E-11	6953	33	LPG 1

**CUBE**

Cube 1.5 dCi	Z12	1.5	78	03.10 -	K9K	4		Y1035AS	94103	77	
Cube 1.5 dCi	Z12	1.5	81	03.10 -	K9K	4		Y1035AS	94103	77	
Cube 1.6 16V	Z12	1.6	81	03.10 -	HR16DE	4	1,1	LZKAR6AP-11	6643		LZKAR6AP-11

**D 21**

D21		2.5		93 -	TD25			Y-707RS	4937		
D21		2.7		93 -	TD27			Y-707RS	4937		
D21		2.7		93 -	TD27T			Y-712RS	6140		

**EVALIA**

Evalia 1.5 dCi	M20M	1.5	66	04.11 -	K9K	4		Y1035AS	94103	77	
Evalia 1.5 dCi	M20M	1.5	81	04.11 -	K9K	4		Y1035AS	94103	77	
Evalia 1.6 16V	M20M	1.6	81	07.10 -	HR16DE	4	1,1	PLZKAR6A-11	5118		PLZKAR6A-11

**GLORIA**

Gloria	MY34	2.5		06.99 - 06.00	VQ25DD Ne-Di	4	1,1	PFR5P-11	4341		PFR5P-11
Gloria		2.5		06.00 -	VQ25DD	4	1,1	FR5BP-11	6247		

**INTERSTAR**

Interstar dCi 80	X70	1.9	60	07.02 -	F9Q772	4		Y-732J	5605	4	
Interstar dCi 90	X70	2.2	66	07.02 -	G9T722	4		Y-517J	3319	66	
Interstar dCi 100	X70	2.5	74	04.06 -	G9U754	4		Y-517J	3319	66	
Interstar dCi 115	X70	2.5	84	04.02 -	G9U720	4		Y-517J	3319	66	
Interstar dCi 120	X70	2.5	88	09.06 -	G9U650	4		Y-517J	3319	66	
Interstar dCi 150	X70	2.5	107	09.06 -	G9U632	4		Y-517J	3319	66	

**JUKE**

Juke 1.5 dCi	F15E	1.5	81	06.10 -	K9K	4		Y1035AS	94103	77	
Juke 1.6	F15E	1.6	86	06.10 -	HR16DE	4	1,1	DILZKAR6A11	91691		

**KUBISTAR**

Kubistar 1.2	X76	1.1	43	03 -	D7F	4		BKR5EK	7956	23	LPG 1
Kubistar 1.2 16V	X76	1.2	55	04.06 -	D4F-712	4	0,8	LZKAR7A	6799		LZKAR7A
Kubistar Cdi	X76	1.5	48	08.03 -	K9K	4		Y-732J	5605	4	
Kubistar Cdi	X76	1.5	60	08.03 -	K9K	4		Y-732J	5605	4	
Kubistar 1.6 16V	X76	1.6	70	09.03 -	K4M-720 / 744 / 745 / 748	4	0,9	BKR6E	6962	28	LPG 1

**MAXIMA**

Maxima	J30	3.0	125	10.88 - 95	VG30E	6	1,1	BKR6ES-11	5553	14	LPG 1
Maxima	J30	3.0			VG30DE	6	1,1	PFR5C-11	2271		PFR5C-11

**MAXIMA QX**

Maxima QX	A32	2.0	103	95 - 00	VQ20DE	6	1,1	PFR6G-11	5555		PFR7G
Maxima QX	A32	3.0	141	95 - 00	VQ30DE	6	1,1	PFR6G-11	5555		PFR7G
Maxima QX	A33	2.0	103	00 -	VQ20DE	6	1,1	PFR6G-11	5555		PFR7G

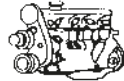
Code *l* kW

Cyl.

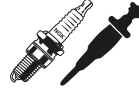

Stock-No.



LPG/CNG

**NISSAN  
MAXIMA QX**

Maxima QX	A33	3.0	147	00 -	VQ30DE	6	1,1	PFR6G-11	5555		PFR7G
-----------	-----	-----	-----	------	--------	---	-----	----------	------	--	-------

**MICRA 1**

Micra 1.0	K10	1.0	37	12.82 - 92	MA10S	4	0,9	BPR5ES	7422	6	LPG 2
Micra 1.0	K10	1.0	40	93 -	MA10	4	0,9	BPR5ES	7422	6	LPG 2
Micra 1.2	K10	1.2	40	01.86 - 93	MA12	4	1,1	BPR5ES-11	4424		LPG 2
Micra 1.3 Super S	K10	1.3	55	93 -	CG13DE	4	1,1	BKR5E-11	6953	33	LPG 1

**MICRA 2**

Micra 1.0 16V	K11	1.0	40	93 - 00	CG10DE Cat.	4	1,1	BKR5E-11	6953	33	LPG 1
Micra 1.0	K11	1.0	44	00 - 02	CG10DE	4	1,1	BKR5E-11	6953	33	LPG 1
Micra 1.3 16V	K11	1.3	55	93 - 00	CG13DE Cat.	4	1,1	BKR5E-11	6953	33	LPG 1
Micra 1.3 16 V Sport	K11	1.3	60	00 - 02	CGA3DE	4	1,1	BKR5E-11	6953	33	LPG 1
Micra 1.5 dCi	K11	1.5	42	98 - 00	VJX	4	☑	Y-503J	1009	10	
Micra 1.5 dCi	K11	1.5	42	98 - 00	VJZ	4	☑	Y-503J	1009	10	

**MICRA 3**

Micra 1.0	K12	1.0	48	01.03 - 05.05	CG10DE	4	1,1	LFR5E-11	1669		LPG 7
Micra 1.2	K12	1.2	48	02.03 -	CR12DE	4	1,1	LFR5E-11	1669		LPG 7
Micra 1.2	K12	1.2	59	02.03 -	CR12DE	4	1,1	LFR5E-11	1669		LPG 7
Micra 1.4	K12	1.4	65	02.03 -	CR14DE	4	1,1	LFR5E-11	1669		LPG 7
Micra dCi	K12	1.5	48	04.03 -	K9K	4	☑	Y-732J	5605	4	
Micra dCi	K12	1.5	60	09.03 -	K9K	4	☑	Y-732J	5605	4	
Micra 1.6	K12	1.6	81	07.05 -	HR16DE	4	1,1	PLZKAR6A-11	5118		PLZKAR6A-11
Micra C+C	K12	1.6	81	06 -	HR16DE	4	1,1	PLZKAR6A-11	5118		PLZKAR6A-11
Micra SR160	K12	1.6	85	07 -	HR16DE	4	1,1	PLZKAR6A-11	5118		PLZKAR6A-11

**MICRA 4**

Micra 1.2	K13	1.2	59	05.10 -	HR12DE	3	1,1	LZKAR6AP-11	6643		LZKAR6AP-11
Micra 1.2 DIG	K13	1.2	72	04.11 -	HR12DDR	3	1,1	LZKAR6AP-11	6643		LZKAR6AP-11

**MURANO 1**

Murano 2.5	Z50	2.5		09.04 -	QR25DE	4	1,1	LFR5A-11	6376		LPG 7
Murano 3.5	Z50	3.5	172	12.02 -	VQ35DE	6	1,1	PLFR5A-11	6240		LPG 7

**MURANO 2**

Murano II 3.5	Z51	3.5	188	10.08 -	VQ35DE	6	1,1	DF7H-11B	1317		
Murano II 3.5	Z51	3.5	191	01.10 -	VQ35DE	6	1,1	DF7H-11B	1317		
Murano II 3.5	Z51	3.5	195	11.07 -	VQ35DE	6	1,1	DF7H-11B	1317		

**NAVARA**

Navara 2.5 dCi d22		2.5	128	05 -	YD25DDTI	4	☑	Y-519J	93293	61	
--------------------	--	-----	-----	------	----------	---	---	--------	-------	----	--

**NOMAD**

Nomad		2.0			LD20		☑	CY51	2696		
-------	--	-----	--	--	------	--	---	------	------	--	--

**NOTE**

Note 1.4	E11	1.4	65	03.06 -	CR14DE	4	1,1	LFR5E-11	1669		LPG 7
Note 1.5 dCi	E11	1.5	50	03.06 -	K9K 700	4	☑	Y-732J	5605	4	
Note 1.5 dCi	E11	1.5	63	03.06 -	K9K	4	☑	Y-732J	5605	4	
Note 1.5 dCi	E11	1.5	66	09.10 -	K9K 276	4	☑	Y1035AS	94103	77	
Note 1.6	E11	1.6	81	03.06 -		4	1,1	PLZKAR6A-11	5118		PLZKAR6A-11
Note 1.6	E11	1.6	85	03.06 -	HR16DE	4	1,1	PLZKAR6A-11	5118		PLZKAR6A-11

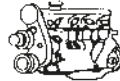

Code *l* kW

Cyl.

Stock-No.  
**V-TUNE**  
BY-PROMOTER

LPG/CNG

**NISSAN****NV 200**

NV200 1.5 dCi	M20M	1.5	66	04.11 -	K9K	4	☑	Y1035AS	94103	77	
NV200 1.5 dCi	M20M	1.6	81	04.11 -	K9K	4	☑	Y1035AS	94103	77	
NV200 1.6 16V	M20M	1.6	81	02.10 -	HR16DE	4	1,1	PLZKAR6A-11	5118		PLZKAR6A-11

**PATHFINDER**

Pathfinder 2.5 dCi		2.5	128	04.05 -	YD25DDTI	4	☑	Y-519J	93293	61	
Pathfinder	D21	2.0			Z20S	4	0,8	BPR6ES	7822	2	LPG 2
Pathfinder	D21	2.4			KA24	6	1,1	ZFR5E-11	4435		
Pathfinder	D21	2.4			Z24i	6	0,9	BPR5ES	7422	6	LPG 2
Pathfinder	D21	2.4			Z24S	6	0,8	BPR6ES	7822	2	LPG 2
Pathfinder	D21	2.5		93 -	TD25	4	☑	Y-707RS	4937		
Pathfinder	D21	2.7		93 -	TD27	4	☑	Y-707RS	4937		
Pathfinder	D21	2.7		93 -	TD27T	4	☑	Y-712RS	6140		
Pathfinder	D21	3.0			VG30i	6	1,1	BCPR5ES-11	3524		LPG 3
Pathfinder	D21	3.0		92 -	VG30E	6	0,9	BKR6EY	3696		LPG 1
Pathfinder	R50	3.3	110	92 - 12.00	VG33E V6	6	1,1	BKR5E-11	6953	33	LPG 1
Pathfinder	R50	3.3	110	97 - 00	VG33E V6	6	1,1	BKR5ES-11	2382	33	LPG 1
Pathfinder	R50	3.5	162	01.00 -	VQ35E V6	6	1,1	PLFR5A-11	6240		LPG 7
Pathfinder	R51M	4.0	198	09.05 -	VQ40DE	6	1,1	LFR5AIX-11	4469		LPG 7

**PATROL**

Patrol	Y60 / 260	2.0		04.89 -	RB30S	4	0,9	BKR6E	6962	28	LPG 1
Patrol		2.7		02.93 -	TD27	6	☑	Y-707RS	4937		
Patrol (4,5,6 Cyl CX51.)(1,2,3 Cyl.CZ51)	Y61	2.8	95	04.98 -	RD28 only if NGK is OE	6	☑	CX51	2896		
							☑	+ CZ51	+3209		
Patrol (4,5,6 Cyl CX51.)(1,2,3 Cyl.CZ51)	Y60 / 160	2.8			RD28T	6	☑	CX51	2896		
							☑	+ CZ51	+3209		
Patrol 3.0 Di	Y61	3.0	116	05.00 - 06	ZD30DDTi only if NGK is OE	4	☑	CZ71	6836		
Patrol 3.0 Di	Y61	3.0	116	06 - 09	ZD30DDTi only if NGK is OE	4	☑	Y-522J	5939		
Patrol		3.3		11.84 -	SD33 12V	6	☑	Y-705RS	1249		
Patrol		3.3		11.84 -	SD33 24V	6	☑	Y-755RS	7771		
Patrol		3.3		11.84 -	SD33T 12V	6	☑	Y-705RS	1249		
Patrol		3.3		11.84 -	SD33T 24V	6	☑	Y-755RS	7771		
Patrol		4.2		- 92	TB42S	6	0,8	BP5ES	6511	8	LPG 2
Patrol		4.2			TD42 12V	6	☑	Y-707RS	4937		
Patrol		4.2			TD42 24V	6	☑	Y-757RS	4018		
Patrol	160	4.2		- 12.98	TD42 12V	6	☑	Y-707RS	4937		
Patrol	160	4.2		- 12.98	TD42 24V	6	☑	Y-757RS	4018		
Patrol	Y60	4.2		88 - 12.95	TB42S	6	0,7	BP6ES	7811	4	LPG 2
Patrol	Y60	4.2		93 - 94	RB42S	6	0,9	BPR5E	7281	6	LPG 2
Patrol	Y60	4.2		93 -	TB42E	6	0,9	BPR5E	7281	6	LPG 2
Patrol		4.5		98 -	TB45E	6	1,1	BPR5E-11	5638		LPG 2

**PICK UP**

Pick-Up	B120	1.2		93 -	A12	4	0,8	BP5ES	6511	8	LPG 2
Pick-Up	D21	1.6		09.85 -	Z16	4	0,8	BPR6ES	7822	2	LPG 2
Pick-Up	D21	2.0		09.85 - 04.92	Z20	4	0,8	BPR6ES	7822	2	LPG 2
Pick-Up	D21	2.0		04.92 -	Z20S	4	0,8	BPR6ES	7822	2	LPG 2
Pick-Up	720	2.2	71	03.86 - 04.93	Z22	4	0,7	BP6ES	7811	4	LPG 2
Pick-Up	720	2.3		87 -	SD23	4	☑	Y-705RS	1249		
Pick-Up	D21	2.4	74	09.85 - 04.92	Z24	4	0,8	BPR6ES	7822	2	LPG 2

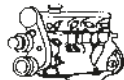
Code *l* kW

Cyl.



Stock-No.



LPG/CNG

**NISSAN  
PICK UP**

Pick-Up	D21	2.4	76	10.88 - 04.92	Z24i	4	0,8	BPR6ES	7822	2	LPG 2
Pick-Up	D21	2.4	88	98 - 01	KA24E	4	1,1	ZFR5E-11	4435		
Pick-Up	MD21	2.4	93	94 - 98	KA24E	4	1,1	ZFR5E-11	4435		
Pick-Up	D22	2.4	98	02 -	KA24E	4	1,1	BKR6E-11	2756	14	LPG 1
Pick Up		2.5	98	12.01 -	YD25DDTi	4		Y-519J	93293	61	
Pick-Up	720	2.5		87 -	SD25	4		Y-705RS	1249		
Pick Up		3.0		90 -	VG30I	6	1,1	BCPR5ES-11	3524		LPG 3
Pick Up		3.0		93 -	VG30E	6	0,9	BKR6EY	3696		LPG 1

**PIXO**

Pixo	UA0	1.0	50	06.09 -	K10B	3	1,1	IKR6G11	7980		IKR6G11
------	-----	-----	----	---------	------	---	-----	---------	------	--	---------

**PRAIRIE**

Prairie	M11	2.0	98	93 - 95	CA20S	4	0,7	BCP6ES	4930	17	LPG 3
Prairie	M11	2.0		90 - 92	CA20S	4	0,8	BCPR6ES	2330	12	LPG 3
Prairie	M11	2.4	98	94 - 95	KA24E		1,1	ZFR5E-11	4435		
Prairie	M11	3.0	98	92 - 95	KA24E	4	1,1	ZFR5E-11	4435		
Prairie 4 x EX + 4 x IN	M11	2.0	72	10.88 - 92	CA20E Twin Spark Cat.	4	1,1	BCPR5ES-11 + BCPR6ES-11	3524 + 7121		LPG 3 * 8 pcs
Prairie 4 x EX + 4 x IN	M11	2.0	73	10.88 - 92	CA20E Twin Spark	4	1,1	BCPR5ES-11 + BCPR6ES-11	3524 + 7121		LPG 3 * 8 pcs
Prairie 4 x EX + 4 x IN	M11	2.0	98	93 - 95	CA20E Twin Spark	4	1,1	BCPR5ES-11 + BCPR6ES-11	3524 + 7121		LPG 3 * 8 pcs

**PRIMASTAR**

Primastar dCi 80	X83	1.9	60	03.01 -		4		Y-732J	5605	4	
Primastar dCi 100	X83	1.9	74	03.01 -		4		Y-732J	5605	4	
Primastar J4	X83	2.0	88	03 -	F4R	4	0,9	BKR6EZ	4619	38	LPG 1
Primastar dCi 140	X83	2.5	99	09.03 -	G9U730	4		Y-517J	3319	66	
Primastar dCi 150	X83	2.5	107	09.06 -	G9U632	4		Y-517J	3319	66	

**PRIMERA 1**

Primera 1.6	P10	1.6	66	07.90 - 93	GA16DS Cat.	4	0,9	BKR6E	6962	28	LPG 1
Primera 1.6	P10	1.6	66	93 - 97	GA16DE	4	0,9	BKR5EY	7390		LPG 1
Primera 1.6	P10	1.6	66	93 -	GA16DS	4	0,9	BKR6E	6962	28	LPG 1
Primera 1.6	P10	1.6	66	93 - 96	GA16DE	4	0,8	BKR5E	7938	35	LPG 1
Primera 1.6	P10	1.6	66	93 -	GA16DS	4	0,9	BKR6EY	3696		LPG 1
Primera 1.6	P10E	1.6	66	06.90 - 93	GA16DS Cat.	4	0,9	BKR6E	6962	28	LPG 1
Primera 1.6	P10	1.6	70	07.90 - 93	GA16DS	4	0,9	BKR6E	6962	28	LPG 1
Primera 1.6	P10E	1.6	70	06.90 - 92	GA16DS	4	0,9	BKR6E	6962	28	LPG 1
Primera 2.0	P10	2.0	55	07.90 - 04.96	CD20	4		CY52	3017		
Primera 2.0	P10	2.0	55	01.91 - 06.96	CD20	4		CY52	3017		
Primera 2.0	P10	2.0	85	07.90 - 96	SR20Di	4	0,9	BKR5EY	7390		LPG 1
Primera 2.0	P10	2.0	85	93 - 96	SR20DE	4	0,9	BKR5EY	7390		LPG 1
Primera 2.0	P10E	2.0	85	06.90 - 96	SR20Di	4	0,9	BKR5EY	7390		LPG 1
Primera 2.0	P10	2.0	89	07.90 - 96	SR20Di SPI	4	0,9	BKR5EY	7390		LPG 1
Primera 2.0	P10E	2.0	89	06.90 - 96	SR20Di SPI	4	0,9	BKR5EY	7390		LPG 1
Primera 2.0	P10E	2.0	110	06.90 - 96	SR20DE EGI Cat.	4	0,9	BKR6EY	3696		LPG 1

**PRIMERA 2**

Primera 1.6	P11	1.6	66	96 -	GA16DE	4	0,9	BKR6E	6962	28	LPG 1
Primera 1.6 16V	P11	1.6	74	09.96 - 00	GA16DE	4	0,8	BKR5E	7938	35	LPG 1
Primera 1.6	P11	1.6	78	02.00 - 07.02	QG16DE	4	1,1	BKR5E-11	6953	33	LPG 1

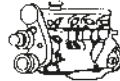
Code *l* kW

Cyl.

Stock-No.  
**V-TUNE**  
BY-PROMOTER

LPG/CNG

**NISSAN****PRIMERA 2**

Primera 1.8	P11	1.8	83	02.00 - 02	QG18DE	4	1,1	BKR5E-11	6953	33	LPG 1
Primera 2.0 16V	P11	2.0	85	09.96 - 99	SR20DE	4	1,1	BKR5EY-11	2355		LPG 1
Primera 2.0	P11	2.0	91	96 - 99	SR20DE	4	0,9	BKR5EY	7390		LPG 1
Primera 2.0 16V	P11	2.0	96	09.96 - 99	SR20DE	4	1,1	BKR5EY-11	2355		LPG 1
Primera 2.0	P11	2.0	103	00 - 02	SR20DE	4	1,1	PFR6G-11	5555		PFR7G
Primera 2.0	P11	2.0	109	96 - 99	SR20DE	4	0,9	BKR5EY	7390		LPG 1
Primera 2.0	P11	2.0	110	06.97 - 99	SR20DE	4	0,9	BKR6EY	3696		LPG 1
Primera 2.0 GT UK	P11	2.0	110	04.97 -	SR20DE	4	1,1	BKR5EY-11	2355		LPG 1

**PRIMERA 3**

Primera 1.6	P12	1.6	78	01.02 -	QG16DE	4	1,1	LFR5A-11	6376		LPG 7
Primera 1.8	P12	1.8	85	03.02 -	QG18DE	4	1,1	LFR5A-11	6376		LPG 7
Primera 1.8 Traveller	P12	1.8	85	03.02 -	QG18DE	4	1,1	LFR5A-11	6376		LPG 7
Primera 1.9 dCi	P12	1.9	88	09.03 -	F9Q...	4	█	Y-732J	5605	4	
Primera 2.0	P12	2.0	103	03.02 -	QR20DE	4	1,1	LFR5A-11	6376		LPG 7
Primera 2.0	P12	2.0		08.01 - 06.03	SR20VE	4	0,9	PLFR6A-9	4342		LPG 7
Primera 2.0 Wagon	P12	2.0		08.01 - 06.03	SR20VE	4	0,9	PLFR6A-9	4342		LPG 7
Primera 2.2 Di	P12	2.2	93	03.02 -	YD22ET	4	█	Y-519J	93293	61	
Primera 2.2 dCi	P12	2.2	102	04.03 -	YD22DDT	4	█	Y-519J	93293	61	

**QASHQAI**

Qashqai 1.5 dCi	J10	1.5	76	07.08 - 06.10	K9K	4	█	Y-732J	5605	4	
Qashqai 1.5 dCi	J10	1.5	78	02.07 - 06.10	K9K	4	█	Y-732J	5605	4	
Qashqai 1.6	J10	1.6	84	02.07 -	HR16DE	4	1,1	PLZKAR6A-11	5118		PLZKAR6A-11
Qashqai 2.0	J10	2.0	104	02.07 -	MR20DE	4	1,1	PLZKAR6A-11	5118		PLZKAR6A-11

**SERENA**

Serena 1.6	C23M	1.6	71	07.93 -	GA16DE Cat.	4	0,8	BKR5E	7938	35	LPG 1
Serena 2.0 D	C23M	2.0	49	07.92 - 01.96	LD20	4	█	CY51	2696		
Serena 2.0	C23M	2.0	93	01.92 -	SR20DE Cat.	4	0,9	BKR5EY	7390		LPG 1
Serena 2.3 D	C23M	2.3	55	01.95 - 02.98	LD23	4	█	Y-712RS	6140		
Serena 2.3 D	C23M	2.3	55	03.98 -	LD23	4	█	Y-530J	6586		
Serena 2.0	C25	2.0		05.05 -	MR20DE	4	1,1	LZKAR6AP-11	6643		LZKAR6AP-11

**SILVIA**

Silvia RS12 4x EX + 4 x IN		1.8	90	89 - 95	CA18E	4	1,1	BCPR5ES-11	3524		LPG 3 * 8 pcs
								+ BCPR6ES-11	+ 7121		
Silvia Turbo 4x EX + 4 x IN S12(CH)		1.8	90	10.83 - 95	CA18ET Cat.	4	1,1	BCPR5ES-11	3524		LPG 3 * 8 pcs
								+ BCPR6ES-11	+ 7121		

**SKYLINE**

Skyline V6 24V	V35	2.5	158	02 -	VQ25DD	6	1,1	LFR5AIX-11	4469		LPG 7
Skyline	V35	2.6		98 -	RB26DETT	6	1,1	PFR7A-11	4579		PFR7A-11
Skyline V6 24V	V35	3.0	191	02 -	VQ30DD	6	1,1	LFR5AIX-11	4469		LPG 7
Skyline V6 24V	V35	3.5	200	02 -	VQ35DE	6	1,1	LFR5AIX-11	4469		LPG 7

**SUNNY**

Sunny 1.0	B13	1.0		93 - 95	E10S Cat.	4	0,8	BP5ES	6511	8	LPG 2
Sunny 1.3	B13	1.3		93 - 95	GA13DS	4	0,9	BKR6E	6962	28	LPG 1
Sunny 1.4	B13	1.4	55	93 - 95	GA14DS	4	0,9	BKR6E	6962	28	LPG 1
Sunny 1.6	B13	1.6		- 96	GA16DE	4	0,9	BKR6E	6962	28	LPG 1
Sunny 1.6	B13	1.6		- 95	GA16DS	4	0,9	BKR6E	6962	28	LPG 1

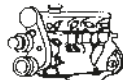
Code *l* kW

Cyl.

Stock-No.  
**VLIVE**  
10-17-19-20-21-22-23-24-25-26-27-28-29-30-31-32-33-34-35-36-37-38-39-40-41-42-43-44-45-46-47-48-49-50-51-52-53-54-55-56-57-58-59-60-61-62-63-64-65-66-67-68-69-70-71-72-73-74-75-76-77-78-79-80-81-82-83-84-85-86-87-88-89-90-91-92-93-94-95-96-97-98-99-100

LPG/CNG

**NISSAN  
SUNNY**

Sunny 1.7 D	B13	1.7	40	93 - 96	CD17	4	█	CY51	2696		
Sunny 2.0	B13	2.0		91 - 96	SR20DE	4	0,9	BKR6EY	3696		LPG 1
Sunny 1.3	B14	1.3		95 -	GA13DE	4	1,1	BKR6E-11	2756	14	LPG 1
Sunny 1.3	B14	1.3		95 -	GA13DS	4	0,9	BKR6E	6962	28	LPG 1
Sunny 1.4	B14	1.4		95 -	GA14DE	4	0,9	BKR6E	6962	28	LPG 1
Sunny 1.6	B14	1.6		95 -	GA16DE	4	1,1	BKR6E-11	2756	14	LPG 1
Sunny 1.8	B14	1.8		95 -	GA18DE(A)	4	1,1	BKR6E-11	2756	14	LPG 1
Sunny 1.8	B14	1.8		95 -	GA18DE(B)	4	0,9	BKR6E	6962	28	LPG 1
Sunny 2.0 D	B14	2.0	55	10.90 -	CD20	4	█	CY52	3017		
Sunny 2.0 D	B14	2.0			CD20	4	█	CY51	2696		
Sunny 2.0	B14	2.0		95 -	SR20DE	4	0,9	BKR6EY	3696		LPG 1
Sunny 1.4	N14	1.4	55	10.90 - 93	GA14DS	4	0,8	BKR5E	7938	35	LPG 1
Sunny 1.4	N14	1.4	55	10.92 - 95	GA14DE	4	0,8	BKR5E	7938	35	LPG 1
Sunny 1.6	N14	1.6	66	10.90 - 93	GA16DS	4	0,9	BKR6E	6962	28	LPG 1
Sunny 1.6	N14	1.6	66	10.92 - 95	GA16DE	4	0,8	BKR5E	7938	35	LPG 1
Sunny 1.6	N14	1.6	75	10.92 - 95	GA16DE	4	0,8	BKR5E	7938	35	LPG 1
Sunny 1.7 D	N14	1.7		91 - 91	CD17	4	█	CY52	3017		
Sunny 2.0 D	N14	2.0	55	10.90 - 95	CD20	4	█	CY52	3017		
Sunny 2.0	N14	2.0		95 -	SR20DET	4	0,6	PFR7B	4853		PFR8B
Sunny 2.0 D	N15	2.0	55	10.90 - 95	CD20	4	█	CY52	3017		
Sunny 1.6	Y10	1.6	66	94 - 00	GA16DS	4	0,9	BKR6E	6962	28	LPG 1
Sunny 1.6	Y10	1.6	67	94 - 00	SR16DE	4	0,8	BKR5E	7938	35	LPG 1
Sunny 1.7 D	Y10	1.7	40	93 - 96	CD17	4	█	CY51	2696		
Sunny 2.0 D	Y10	2.0	55	10.90 - 00	CD20	4	█	CY52	3017		
Sunny 2.0	Y10	2.0	105	93 - 00	GA20DE	4	0,9	BKR6EY	3696		LPG 1
Sunny 1.6	Y10L	1.6	66	10.90 - 93	GA16DS	4	0,9	BKR6E	6962	28	LPG 1
Sunny 1.6	Y10L	1.6	66	10.92 - 00	GA16DE	4	0,8	BKR5E	7938	35	LPG 1
Sunny 1.7 D	Y11	1.7	40	05.92 - 04.98	CD17	4	█	CY51	2696		
Sunny GTI	N14	2.0	105	10.90 - 05.95	SR20DE Cat.	4	0,9	BKR6EY	3696		LPG 1
Sunny GTI-R	N14	2.0	162	10.93 - 95	SR20DET Cat.	4	0,9	PFR7B-9	4180		PFR8B

**TEANA**

Teana 3.5	J32	3.5	185	07.08 -	VQ35DE	6	1,1	DF7H-11B	1317		
-----------	-----	-----	-----	---------	--------	---	-----	----------	------	--	--

**TERRANO 1**

Terrano 1	WD21	2.0			Z20S	4	0,8	BPR6ES	7822	2	LPG 2
Terrano 1 4 x EX + 4 x IN	WD21	2.4	76	08.86 - 92	Z24i Twin Spark	4	0,9	BPR5ES	7422	6	LPG 2 * 8 pcs
Terrano 1	WD21	2.4	76	08.87 - 07.92	Z24i Cat.	6	0,9	BPR5ES	7422	6	LPG 2
Terrano 1	WD21	2.5		- 95	TD25	4	█	Y-707RS	4937		
Terrano 1	WD21	2.7		- 95	TD27	4	█	Y-707RS	4937		
Terrano 1	WD21	3.0	109	01.90 - 07.96	VG30E Cat.	6	0,9	BKR6EY	3696		LPG 1

**TERRANO 2**

Terrano 2	R20	2.4	86	05.96 - 01	KA24E	6	1,1	ZFR5E-11	4435		
Terrano 2	R20	2.4	87	05.96 - 01	KA24E	6	1,1	ZFR5E-11	4435		
Terrano 2	R20	2.4	91	07.93 - 96	KA24E	6	1,1	ZFR5E-11	4435		
Terrano 2 Tdi only Europa	R20	2.7	92	05.96 - 02	TD27T For EU	4	█	CY58	5486		
Terrano 2 not Europe	R20	2.7		07.93 - 02	TD27T	4	█	Y-712RS	6140		
Terrano 2	R20	3.0	113	05.02 -	ZD30DDTI only if NGK is OE	4	█	CZ71	6836		

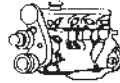
Code *l* kW

Cyl.



Stock-No.

LPG/CNG

**NISSAN****TIIDA**

Tiida 1.6	C11X	1.6	81	01.08 -	HR16DE	4	1,1	PLZKAR6A-11	5118		PLZKAR6A-11
Tiida 1.8	C11X	1.8	93	01.08 -	MR18DE	4	1,1	PLZKAR6A-11	5118		PLZKAR6A-11

**TINO**

Tino 1.8 16V V10		1.8	88	99 -	NEOQG18DE	4	1,1	BKR5E-11	6953	33	LPG 1
Tino 2.0 16V V10		2.0	99	99 -	SR20DE	4	1,1	PFR6G-11	5555		PFR7G
Tino 2.0 16V V10		2.2	84	07.00 -	YD22DT	4		Y-519J	93293	61	

**URVAN**

Urvan	E23 / E24	2.0	64	11.86 - 97	Z20 OHC	4	0,9	BPR5ES	7422	6	LPG 2
Urvan	E23 / E24	2.0		95 - 97	NA20S	4	1,1	BPR6ES-11	4824	13	LPG 2
Urvan	E23 / E24	2.4	74	02.87 - 97	Z24S OHC	6	0,9	BPR5ES	7422	6	LPG 2
Urvan	E23 / E24	2.4	74	05.89 - 96	Z24i	6	0,9	BPR5ES	7422	6	LPG 2
Urvan	E23 / E24	2.4		95 - 97	Z24	6	0,7	BP6ES	7811	4	LPG 2
Urvan	E23 / E24	2.5		93 - 97	TD25	4		Y-707RS	4937		
Urvan QGS Type 2	E23 / E24	2.0		05.82 - 98	LD20T	4		Y-204SS	7629		
Urvan QGS Type 2	E23 / E24	2.3		05.82 -	SD23	4		Y-112M1	2531		
Urvan	E23 / E24	2.3		- 97	TD23	4		Y-707RS	4937		
Urvan	E23 / E24	2.3		05.82 - 97	SD23	4		Y-162R1	2431		
Urvan	E23 / E24	2.7		87 - 97	TD27	4		Y-707RS	4937		
Urvan QGS Type 1	E23 / E24	2.0		05.82 - 97	LD20T	4		Y-204RS	4573		
Urvan QGS Type 1	E23 / E24	2.3		05.82 - 97	SD23	4		Y-112R1	1032		

**VANETTE**

Vanette	M20	1.6		09 -	HR16DE	4	1,1	LZKAR6AP-11	6643		LZKAR6AP-11
Vanette		2.0			CD20	4		CY52	3017		
Vanette		2.0		93 -	SR20E	4	0,9	BKR5EY	7390		LPG 1
Vanette		2.3	55	05.98 -	LD23	4		Y-530J	6586		
Vanette	C22	2.4	74	09.86 - 93	Z24i	4	0,9	BPR5ES	7422	6	LPG 2
Vanette	C22	1.5	51	09.86 - 95	A15S	4	0,9	BPR5ES	7422	6	LPG 2
Vanette	C22	2.0	64	09.86 - 95	Z20S	4	0,8	BPR6ES	7822	2	LPG 2
Vanette	C22	2.0	44	04.87 - 11.94	LD20 II OHV	4		CY51	2696		
Vanette	C22	2.0	47	01.91 - 11.94	LD20 IIL	4		CY51	2696		
Vanette	C22	2.0	47	09.86 - 03.93	LD20 OHV	4		CY51	2696		
Vanette Cargo		2.0	49	07.92 - 09.94	LD20 OHV	4		CY51	2696		
Vanette Cargo (NL)		1.6	71	03.95 -		4	0,8	BKR5E	7938	35	LPG 1
Vanette E (NL)		1.6	71	03.95 -		4	0,8	BKR5E	7938	35	LPG 1

**X-TRAIL**

X-Trail 2.0	T30	2.0	103	06.01 -	QR20DE	4	1,1	LFR5A-11	6376		LPG 7
X-Trail 2.0	T30	2.0		02.01 -	SR20VET	4	0,9	PLFR6A-9	4342		LPG 7
X-Trail 2.2 dCi	T30	2.2	84	09.01 - 10.03	YD22DDTi	4		Y-519J	93293	61	
X-Trail 2.2 dCi	T30	2.2	100	11.03 -	YD22DDTi	4		Y-519J	93293	61	
X-Trail 2.5	T30	2.5	121	09.01 - 02.07	QR25DE	4	1,1	LFR5A-11	6376		LPG 7
X-Trail 2.5	T30	2.5	132	11.02 - 02.07	QR25DE	4	1,1	LFR5A-11	6376		LPG 7
X-Trail 2.0	T31	2.0	104	06.07 -	MR20DE	4	1,1	PLZKAR6A-11	5118		PLZKAR6A-11
X-Trail 2.5	T31	2.5	124	06.07 -	QR25DE	4	1,1	DILKAR6A11	9029		DILKAR6A11

**OPEL****ADAM**

Adam 1.2	M13	1.2	51	10.12 -	A12XEL	4	0,9	ZFR6V-G	8894		ZFR6V-G
Adam 1.4	M13	1.4	64	10.12 -	A14XEL	4	0,9	ZFR6V-G	8894		ZFR6V-G
Adam 1.4	M13	1.4	74	10.12 -	A14XER	4	0,9	ZFR6V-G	8894		ZFR6V-G

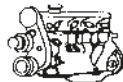

Code *l* kW

Cyl.



Stock-No.



LPG/CNG

**OPEL  
AGILA H00**

Agila 12V	H00	1.0	43	07.00 -	Z10XE	3		BKR5EK	7956	23	LPG 1
Agila 12V	H00	1.0	44	04 -	Z10XEP	3	1,1	ZFR5F-11	2262		LPG 6
Agila 16V	H00	1.2	55	07.00 -	Z12XE	4		BKR5EK	7956	23	LPG 1
Agila 16V	H00	1.2	59	07.04 -	Z12XEP	4	1,1	ZFR5F-11	2262		LPG 6
Agila 1.3 CDTI	H00	1.3	51	08.03 -	Z13DT	4		Y8003J	97256	62	

**AGILA H08 / F68**

Agila 1.0	H08 / F68	1.0	48	05.08 -	K10B	3	1,1	IKR6G11	7980		IKR6G11
Agila 1.0 LPG	H08 / F68	1.0	48	01.10 -	K10B	3	1,1	IKR6G11	7980		IKR6G11
Agila 1.2	H08 / F68	1.2	63	05.08 -	K12B	4	1,1	IKR6G11	7980		IKR6G11
Agila 1.2	H08 / F68	1.2	69	06.10 -	K12B	4	1,1	IKR6G11	7980		IKR6G11
Agila 1.2 LPG	H08 / F68	1.2	63	01.10 -	K12B	4	1,1	IKR6G11	7980		IKR6G11

**ANTARA**

Antara 2.4		2.4	103	09.06 -	Z24XED	4		BKR5EK	7956	23	LPG 1
Antara 3.2		3.2	167	09.06 -	Z32SE	6	1,3	PTR5A-13	2467	25	LPG 4

**ARENA**

Arena 1.9D		1.9	44	01.98 -	F8Q M6	4		Y-506R	4409	7	
Arena 2.5D		2.5	55	07.98 - 02.01	S8U V7	4		Y-908R	4585	1	

**ASTRA F**

Astra F 1.4		1.4	44	09.91 - 07.95	C14NZ OHC	4	0,9	BPR5ES	7422	6	LPG 2
Astra F 1.4		1.4	44	08.95 - 02.98	C14NZ OHC	4		BKR5EK	7956	23	LPG 1
Astra F 1.4		1.4	44	08.96 - 02.98	X14NZ OHC I	4		BKR5EK	7956	23	LPG 1
Astra F 1.4		1.4	55	09.91 - 03.93	14NV OHC I	4		BKR5EK	7956	23	LPG 1
Astra F 1.4 Si		1.4	60	09.91 - 07.95	C14SE OHC	4	0,9	BPR5ES	7422	6	LPG 2
Astra F 1.4 Si		1.4	60	03.93 - 07.95	14SE OHC	4	0,9	BPR5ES	7422	6	LPG 2
Astra F 1.4 Si		1.4	60	08.95 - 02.98	14SE OHC	4		BKR5EK	7956	23	LPG 1
Astra F 1.4 Si		1.4	60	08.95 - 02.98	C14SE OHC	4		BKR5EK	7956	23	LPG 1
Astra F 1.4 16V		1.4	66	02.96 - 02.98	X14XE DOHC	4		BKR5EK	7956	23	LPG 1
Astra F 1.6		1.6	52	03.93 - 03.94	X16SZ OHC	4	0,9	BPR5ES	7422	6	LPG 2
Astra F 1.6		1.6	52	04.94 - 12.94	X16SZ OHC	4	0,9	BPR5ES	7422	6	LPG 2
Astra F 1.6		1.6	52	01.95 - 02.96	X16SZ OHC	4		BKR5EK	7956	23	LPG 1
Astra F 1.6		1.6	55	09.91 - 07.95	C16NZ OHC	4	0,9	BPR5ES	7422	6	LPG 2
Astra F 1.6		1.6	55	08.94 - 02.98	16LZ2 OHC	4		BKR5EK	7956	23	LPG 1
Astra F 1.6		1.6	55	08.95 - 02.96	C16NZ OHC	4		BKR5EK	7956	23	LPG 1
Astra F 1.6		1.6	55	02.96 - 08.00	X16SZR OHC	4		BKR5EK	7956	23	LPG 1
Astra F 1.6		1.6	55	09.97 -	16NZR OHC	4		BKR5EK	7956	23	LPG 1
Astra F 1.6 Si		1.6	74	02.92 - 07.95	C16SE OHC I	4	0,9	BPR5ES	7422	6	LPG 2
Astra F 1.6 16V		1.6	74	08.94 - 02.98	X16XEL DOHC	4		BKR5EK	7956	23	LPG 1
Astra F 1.6 16V		1.6	74	08.95 - 02.98	C16SE OHC I	4		BKR5EK	7956	23	LPG 1
Astra F 1.7 D		1.7	42	09.91 - 09.92	17 D OHC II	4		Y-924U	4950	1	
Astra F 1.7 D		1.7	44	09.92 - 08.94	17 DR	4		Y-924U	4950	1	
Astra F 1.7 TD Eco		1.7	50	08.94 - 02.98	X17 DTL	4		Y-924U	4950	1	
Astra F 1.7 TD		1.7	60	12.91 - 02.98	17DT TC4 EE1 OHC	4		CY03	6160	8	
Astra F 1.7 TD		1.7	60	04.96 - 02.98	Isuzu Mot.956633—> X17DT TC4 EE1 OHC	4		CY03	6160	8	
Astra F 1.8		1.8	66	09.91 - 07.95	C18NZ OHC II	4	0,9	BPR5ES	7422	6	LPG 2
Astra F 1.8		1.8	66	08.95 - 02.98	C18NZ OHC II	4		BKR5EK	7956	23	LPG 1
Astra F 1.8 16V		1.8	85	02.94 - 03.96	C18XEL DOHC	4		BKR5EK	7956	23	LPG 1
Astra F 1.8 16V		1.8	85	02.96 - 02.98	X18XE DOHC	4		BKR5EK	7956	23	LPG 1

Code *l* kW

Cyl.



Stock-No.



LPG/CNG

**OPEL****ASTRA F**

Astra F 1.8 16V		1.8	92	05.93 - 04.94	C18XE DOHC II	4		BKR5EK	7956	23	LPG 1
Astra F 2.0		2.0	85	09.91 - 07.95	C20NE OHC II	4	0,9	BPR5ES	7422	6	LPG 2
Astra F 2.0		2.0	85	08.95 - 02.98	C20NE OHC II	4		BKR5EK	7956	23	LPG 1
Astra F 2.0 16V		2.0	100	02.95 - 02.98	X20XEV DOHC	4		BKR5EK	7956	23	LPG 1
Astra F 2.0 GSI 16V		2.0	110	09.91 - 08.92	C20XE DOHC	4		BKR6EK	2288	20	LPG 1
Astra F 2.0 GSI 16V		2.0	110	09.91 - 08.92	C20XE-LN DOHC I	4		BKR6EK	2288	20	LPG 1
Astra F 2.0 GSI 16V		2.0	110	09.92 - 02.98	C20XE DOHC	4		BKR5EK	7956	23	LPG 1
Astra F 2.0 GSI 16V		2.0	110	09.92 - 02.98	C20XE-LN DOHC I	4		BKR5EK	7956	23	LPG 1

**ASTRA G**

Astra G 1.2 16V		1.2	48	03.98 - 00	X12XE DOHC	4		BKR5EK	7956	23	LPG 1
Astra G 1.2 16V		1.2	55	08.00 -	Z12XE	4		BKR5EK	7956	23	LPG 1
Astra G 1.4		1.4	66	08.00 -	Z14XE DOHC	4		BKR5EK	7956	23	LPG 1
Astra G 1.4 16V		1.4	66	03.98 -	X14XE DOHC	4		BKR5EK	7956	23	LPG 1
Astra G 1.6		1.6	55	03.98 - 08.00	X16SZR	4		BKR5EK	7956	23	LPG 1
Astra G 1.6		1.6	62	08.00 -	Z16SE	4		BKR5EK	7956	23	LPG 1
Astra G 1.6 CNG		1.6	71	09.02 - 06.04	Z16YNG	4		LPG 1	1496		LPG 1
Astra G 1.6 16V		1.6	74	03.98 -	X16XEL	4		BKR5EK	7956	23	LPG 1
Astra G 1.6 16V		1.6	74	03.03 -	Z16XEP	4	1,1	ZFR5F-11	2262		LPG 6
Astra G 1.6 16V		1.6	74	08.00 -	Z16XE	4		BKR5EK	7956	23	LPG 1
Astra G 1.7 TD		1.7	50	02.98 -	X17DTL	4	☑	Y-924U	4950	1	
Astra G 1.7 DTI 16V		1.7	55	02.00 - 01.05	Y17DT	4	☑	Y-541J	1983	42	
Astra G 1.7 CDTI		1.7	59	04.03 - 01.05	Z17DTL	4	☑	Y-541J	1983	42	
Astra G 1.8 16V		1.8	85	03.98 -	X18XE1	4		BKR5EK	7956	23	LPG 1
Astra G 1.8 16V		1.8	85	08.00 -	Z18XEL	4		BKR5EQUPA	3566		
Astra G 1.8 16V		1.8	92	08.00 -	Z18XE	4		BKR5EK	7956	23	LPG 1
Astra G 2.0 DI		2.0	60	02.98 -	X20DTL SOHC	4	☑	Y-748U	6649	14	
Astra G 2.0 DI		2.0	60	08.00 -	Y20DTL	4	☑	Y-748U	6649	14	
Astra G 2.0 DTI II 16V to chassis no. 2H999999		2.0	74	08.00 -	Y20DTH	4	☑	Y-748U	6649	14	
Astra G 2.0 DTI II 16V from chassis no. 3H000001		2.0	74	08.00 -	Y20DTH	4	☑	Y-523J	6298	37	
Astra G 2.0 16V		2.0	100	03.98 -	X20XEV	4		BKR5EK	7956	23	LPG 1
Astra G 2.0 16V		2.0	118	10.99 - 09.02	X20XER DOHC	4		BKR5EK	7956	23	LPG 1
Astra G 2.0 OPC Turbo		2.0	140	09.00 -	Z20LET	4		BKR5EK	7956	23	LPG 1
Astra G 2.0 OPC Turbo		2.0	147	11.02 - 05.05	Z20LER	4	0,7	ZFR5F	5165		LPG 6
Astra G 2.2 DTI		2.2	92	03 -	Y22DTR	4	☑	Y-523J	6298	37	
Astra G 2.2 16V		2.2	108	09.00 - 06	Z22SE	4		LTR6B-10T	5948		LTR6B-10T
Astra G 2.2 16V		2.2	108	01.99 -	X22XE DOHC	4		BKR5EK	7956	23	LPG 1

**ASTRA H**

Astra H 1.3 CDTI		1.3	66	06.04 -	Z13DTH	4		Y8003J	97256	62	
Astra H 1.4		1.4	55	03.04 -	Z14XEL	4	1,1	ZFR5F-11	2262		LPG 6
Astra H 1.4		1.4	66	03.04 -	Z14XEP	4	1,1	ZFR5F-11	2262		LPG 6
Astra H 1.6		1.6	71	08.06 -	Z16YNG	4		LPG 1	1496		LPG 1
Astra H 1.6		1.6	74	03.04 -	Z16XEP	4	1,1	ZFR5F-11	2262		LPG 6
Astra H 1.6		1.6	85	01.07 -	Z16XER	4	1,1	ZFR5F-11	2262		LPG 6
Astra H 1.6 Turbo		1.6	132	10.06 -	Z16LET	4	0,9	ZFR6BP-G	1748		ZFR6BP-G
Astra H 1.7 CDTI		1.7	59	03.04 -	Z17DTL	4	☑	Y-541J	1983	42	
Astra H 1.7 CDTI		1.7	74	03.04 -	Z17DTH	4	☑	Y-541J	1983	42	
Astra H 1.7 CDTI		1.7	92	02.07 -	A17DTR	4	☑	Y-541J	1983	42	
Astra H 1.7 CDTI		1.7	92	03.07 -	Z17DTR	4	☑	Y-541J	1983	42	

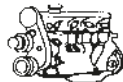
Code *l* kW

Cyl.



Stock-No.



LPG/CNG

**OPEL  
ASTRA H**

Astra H 1.8		1.8	92	03.04 -	Z18XE	4	1,1	ZFR5F-11	2262		LPG 6
Astra H 1.8		1.8	103	05.06 -	Z18XER	4	1,1	ZFR5F-11	2262		LPG 6
Astra H 1.9 CDTI bis Fgst.-Nr. 72045139		1.9	74	09.05 -	Z19DTL	4	█	Y-534J	3413	36	
Astra H 1.9 CDTI ab Fgst.-Nr. 72045140		1.9	74	09.05 -	Z19DTL	4	█	Y1030J	90828	70	
Astra H 1.9 CDTI bis Fgst.-Nr. 72045139		1.9	88	04.04 -	Z19DT	4	█	Y-534J	3413	36	
Astra H 1.9 CDTI ab Fgst.-Nr. 72045140		1.9	88	04.04 -	Z19DT	4	█	Y1030J	90828	70	
Astra H 1.9 CDTI		1.9	88	04.05 -	Z19DTJ	4	█	YE07	6092		
Astra H 1.9 CDTI 16V		1.9	110	09.04 -	Z19DTH	4	█	YE07	6092		
Astra H 2.0 Turbo		2.0	125	03.04 -	Z20LEL	4	0,7	ZFR5F	5165		LPG 6
Astra H 2.0 Turbo		2.0	147	03.05 -	Z20LER	4	0,7	ZFR5F	5165		LPG 6
Astra H 2.0 Turbo OPC		2.0	177	09.05 -	Z20LEH	4		PFR6T-G	6314		PFR6T-G

**ASTRA J**

Astra J 1.4		1.4	64	10.09 -	A14XEL	4	0,9	ZFR6V-G	8894		ZFR6V-G
Astra J 1.4		1.4	74	10.09 -	A14XER	4	0,9	ZFR6V-G	8894		ZFR6V-G
Astra J 1.4 Turbo		1.4	88	07.10 -	A14NEL	4	0,7	IFR7X7G	91039		IFR7X7G
Astra J 1.4 Turbo		1.4	103	10.09 -	A14NET	4	0,7	IFR7X7G	91039		IFR7X7G
Astra J 1.4 LPG		1.4	103	10.09 -	A14NET	4	0,7	IFR7X7G	91039		IFR7X7G
Astra J 1.6		1.6	85	10.09 -	A16XER	4	0,9	ZFR6V-G	8894		ZFR6V-G
Astra J 1.6 Turbo		1.6	132	10.09 -	A16LET	4	0,9	ZFR6BP-G	1748		ZFR6BP-G
Astra J 1.8 GTC		1.8	103	10.11 -	A18XER	4	0,9	ZFR6V-G	8894		ZFR6V-G

**CALIBRA**

Calibra 2.0		2.0	85	06.90 - 07.95	C20NE OHC II	4	0,9	BPR5ES	7422	6	LPG 2
Calibra 2.0		2.0	85	08.95 - 08.97	C20NE OHC II	4		BKR5EK	7956	23	LPG 1
Calibra 2.0 16V		2.0	100	11.93 - 08.97	X20XEV DOHC	4		BKR5EK	7956	23	LPG 1
Calibra 2.0 16V		2.0	110	02.90 - 08.92	C20XE	4		BKR6EK	2288	20	LPG 1
Calibra 2.0 16V		2.0	110	06.90 - 04.97	C20XE-LN DOHC	4		BKR6EK	2288	20	LPG 1
Calibra 2.0 16V		2.0	110	09.92 - 02.94	C20XE	4		BKR5EK	7956	23	LPG 1
Calibra 2.0 Turbo		2.0	150	03.92 - 08.97	C20LET DOHC	4	1,1	ZFR6F-11	4291		LPG 6
Calibra 2.5 V6		2.5	125	09.93 - 08.97	C25XE DOHC	6		BKR5EK	7956	23	LPG 1
Calibra 2.5 V6		2.5	125	09.93 - 08.97	X25XE DOHC	6		BKR5EK	7956	23	LPG 1

**CAMPO**

Campo 2.3		2.3	72	08.94 - 08.95	4ZD1	4	0,8	BPR6ES	7822	2	LPG 2
Campo 2.5 TD		2.5	56	07.94 -	4JA1T (25 DT)	4	█	Y-904M1	7995		
Campo 3.1 TD		3.1	80	09.92 -	4JG2T (31 TD/TDS)	4	█	Y-719RS1	6900		

**COMBO**

Combo 1.3 CDTI		1.3	51	10.04 -	Y13DT	4	█	Y8003J	97256	62	
Combo 1.3 CDTI		1.3	55	10.05 -	Y13DTJ	4	█	Y8003J	97256	62	
Combo 1.4		1.4	44	03.93 - 10.01	C14NZ OHC	4		BKR5EK	7956	23	LPG 1
Combo 1.4		1.4	44	02.96 - 10.01	X14SZ OHC	4		BKR5EK	7956	23	LPG 1
Combo 1.4		1.4	60	03.93 - 10.01	C14SE OHC	4		BKR5EK	7956	23	LPG 1
Combo 1.4		1.4	66	10.04 -	Z14XEP	4	0,7	ZFR5F	5165		LPG 6
Combo 1.6		1.6	64	10.01 -	Z16SE	4		BKR5EK	7956	23	LPG 1
Combo 1.6 CNG		1.6	69	05 -	Y16YNG	4		LPG 1	1496		LPG 1
Combo 1.6 CNG		1.6	71	08.05 -	Z16YNG	4		LPG 1	1496		LPG 1
Combo 1.7 D		1.7	44	07.94 - 10.01	17D 4EE1 OHC	4	█	CY03	6160	8	
Combo 1.7 D		1.7	44	04.96 - 10.01	X17D (4EE1)/OHC	4	█	CY03	6160	8	
Combo 1.7 DI 16V		1.7	48	10.01 -	Y17DTL	4	█	Y-541J	1983	42	
Combo 1.7 DTI 16V		1.7	55	10.01 -	Y17DT	4	█	Y-541J	1983	42	
Combo 1.7 CDTI 16V		1.7	74	12.04 -	Z17DTH	4	█	Y-541J	1983	42	

Fgst = Chassis No.

Code *l* kW

Cyl.

Stock-No.  
**VEFINE**  
BY-PROMOTER

LPG/CNG

**OPEL****CORSA A**

Corsa A 1.0		1.0	33	09.82 - 09.92	10S OHV	4	0,7	BPR6HS	7022	3	BPR7HIX
Corsa A 1.2		1.2	33	02.90 - 03.93	12NV OHC I	4	0,8	BPR6ES	7822	2	LPG 2
Corsa A 1.2		1.2	33	09.90 - 03.93	C12NZ OHC I	4	0,9	BPR5ES	7422	6	LPG 2
Corsa A 1.2		1.2	37	09.82 - 03.93	12S OHC	4	0,8	BPR6ES	7822	2	LPG 2
Corsa A 1.2		1.2	37	09.86 - 03.93	A12ST OHC	4	0,8	BPR6ES	7822	2	LPG 2
Corsa A 1.2		1.2	40	09.84 - 03.93	S12ST OHC	4	0,8	BPR6ES	7822	2	LPG 2
Corsa A 1.3		1.3	51	09.82 - 03.93	13S OHC	4	0,8	BPR6ES	7822	2	LPG 2
Corsa A 1.3 Sprint		1.3	61	04.85 - 03.93	13E irmscher	4	0,8	BPR6ES	7822	2	LPG 2
Corsa A 1.4		1.4	44	10.89 - 03.93	C14NZ OHC	4	0,9	BPR5ES	7422	6	LPG 2
Corsa A 1.4		1.4	53	10.89 - 09.92	14NV OHC I	4	0,8	BPR6ES	7822	2	LPG 2
Corsa A 1.4		1.4	60	09.91 - 03.93	C14SE OHC	4	0,9	BPR5ES	7422	6	LPG 2
Corsa A 1.5 D (Isuzu-Mot.)		1.5	37	09.87 - 03.93	15 D/4 EC1 AAD → Motor 804 794	4	█	Y-306R	6244		
Corsa A 1.5 D (Isuzu-Mot.)		1.5	37	09.87 - 03.93	15 D/4 EC1 AAD Motor 804795 →	4	█	Y-710J	7880		
Corsa A 1.5 TD (Isuzu-Mot.)		1.5	49	02.88 - 03.93	15DT/T4 EC1-AADT OHC 804795→	4	█	Y-711J	4467	28	
Corsa A 1.6		1.6	55	03.88 - 09.91	C16NZ	4	0,9	BPR5ES	7422	6	LPG 2
Corsa A 1.6		1.6	74	03.88 - 03.92	E16SE OHC I	4	0,8	BPR6ES	7822	2	LPG 2
Corsa A 1.6		1.6	74	02.92 - 03.93	C16SE DOHC	4	0,9	BPR5ES	7422	6	LPG 2
Corsa A 1.6 Irmscher		1.6	72	06.90 - 03.92	C16SEI irmscher	4	0,8	BPR6ES	7822	2	LPG 2

**CORSA B**

Corsa B 1.0 12V		1.0	40	03.97 - 08.00	X10XE DOHC	3		BKR5EK	7956	23	LPG 1
Corsa B 1.2		1.2	33	03.93 - 07.95	12NZ	4	0,9	BPR5ES	7422	6	LPG 2
Corsa B 1.2		1.2	33	03.93 - 07.95	C12NZ OHC I	4	0,9	BPR5ES	7422	6	LPG 2
Corsa B 1.2		1.2	33	03.93 - 07.95	X12SZ OHC	4	0,9	BPR5ES	7422	6	LPG 2
Corsa B 1.2		1.2	33	08.95 - 12.97	12NZ	4		BKR5EK	7956	23	LPG 1
Corsa B 1.2		1.2	33	08.95 - 09.00	C12NZ OHC I	4		BKR5EK	7956	23	LPG 1
Corsa B 1.2		1.2	33	08.95 - 09.00	X12SZ OHC	4		BKR5EK	7956	23	LPG 1
Corsa B 1.2 16V		1.2	48	09.97 - 08.01	X12XE	4		BKR5EK	7956	23	LPG 1
Corsa B 1.4		1.4	44	03.93 - 07.95	C14NZ OHC	4	0,9	BPR5ES	7422	6	LPG 2
Corsa B 1.4		1.4	44	08.95 - 08.98	C14NZ OHC	4		BKR5EK	7956	23	LPG 1
Corsa B 1.4		1.4	44	03.96 - 07.00	X14SZ	4		BKR5EK	7956	23	LPG 1
Corsa B 1.4		1.4	60	03.93 - 07.95	C14SE OHC	4	0,9	BPR5ES	7422	6	LPG 2
Corsa B 1.4		1.4	60	08.95 - 07.97	C14SE OHC	4		BKR5EK	7956	23	LPG 1
Corsa B 1.4		1.4	63	06.98 - 10.00	C14SEL OHC	4		BKR5EK	7956	23	LPG 1
Corsa B 1.4 16V		1.4	66	11.94 - 08.00	X14XE DOHC	4		BKR5EK	7956	23	LPG 1
Corsa B 1.4 16V		1.6	78	08.94 - 08.01	X16XE DOHC	4		BKR5EK	7956	23	LPG 1
Corsa B 1.5 D		1.5	37	03.93 - 08.00	15D (4EC1) OHC Isuzu	4	█	CY03	6160	8	
Corsa B 1.5 D		1.5	49	04.96 - 08.01	X15DT 4EE1 OHC	4	█	CY03	6160	8	
Corsa B 1.5 TD		1.5	49	03.93 - 08.00	X/15DT (T4EC1) OHC Isuzu	4	█	CY03	6160	8	
Corsa B 1.6		1.6	74	06.98 - 10.00	C16SEL DOHC	4		BKR5EK	7956	23	LPG 1
Corsa B 1.6		1.6	80	03.93 - 08.94	C16XE DOHC I	4		BKR5EK	7956	23	LPG 1
Corsa B 1.7 D		1.7	44	04.96 - 08.01	X17D (4EE1)/OHC	4	█	CY03	6160	8	
Corsa B 1.7 TD		1.7	44	03.93 - 08.00	17D (4EE1)/OHC	4	█	CY03	6160	8	

**CORSA C**

Corsa C 1.0 12V		1.0	43	08.00 -	Z10XE	3		BKR5EK	7956	23	LPG 1
Corsa C 1.0 12V		1.0	44	06.03 -	Z10XEP	3	1,1	ZFR5F-11	2262		LPG 6
Corsa C 1.2		1.2	55	08.00 -	Z12XE	4		BKR5EK	7956	23	LPG 1

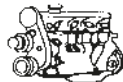
Code *l* kW

Cyl.



Stock-No.



LPG/CNG

**OPEL  
CORSA C**

Corso C 1.2		1.2	59	07.04 -	Z12XEP	4	1,1	ZFR5F-11	2262		LPG 6
Corso C 1.3 CDTI		1.3	51	06.03 -	Z13DT	4	█	Y8003J	97256	62	
Corso C 1.4		1.4	66	08.00 -	Z14XE	4		BKR5EK	7956	23	LPG 1
Corso C 1.4		1.4	66	06.03 -	Z14XEP	4	1,1	ZFR5F-11	2262		LPG 6
Corso C 1.6		1.6	62	08.00 -	Z16SE	4		BKR5EK	7956	23	LPG 1
Corso C 1.6 CNG		1.6	71	04 -	Y16YNG	4		LPG 1	1496		LPG 1
Corso C 1.7 CDTI		1.7	74	06.03 -	Z17DTH	4	█	Y-541J	1983	42	
Corso C 1.7 DI 16V		1.7	48	08.00 -	Y17DTL	4	█	Y-541J	1983	42	
Corso C 1.7 DTI 16V		1.7	55	08.00 -	Y17DT	4	█	Y-541J	1983	42	
Corso C 1.8		1.8	92	08.00 -	Z18XE	4		BKR5EK	7956	23	LPG 1

**CORSA D**

Corso D 1.0		1.0	48	01.10 -	A10XEP	3	0,9	ZFR6V-G	8894		ZFR6V-G
Corso D 1.012V		1.0	44	07.06 -	Z10XEP	3	1,1	ZFR5F-11	2262		LPG 6
Corso D 1.2		1.2	59	07.06 -	Z12XEP	4	1,1	ZFR5F-11	2262		LPG 6
Corso D 1.2		1.3	51	06.10 -	A12XEL	4	0,9	ZFR6V-G	8894		ZFR6V-G
Corso D 1.2		1.3	63	06.10 -	A12XER	4	0,9	ZFR6V-G	8894		ZFR6V-G
Corso D 1.3 CDTI		1.3	66	07.05 -	Z13XDTH	4	█	Y8003J	97256	62	
Corso D 1.3 DTI 16V		1.3	55	07.06 -	Z13DTJ	4	█	Y8003J	97256	62	
Corso D 1.4		1.4	64	01.10 -	A14XEL	4	0,9	ZFR6V-G	8894		ZFR6V-G
Corso D 1.4		1.4	66	07.06 -	Z14XEP	4	1,1	ZFR5F-11	2262		LPG 6
Corso D 1.4		1.4	74	01.10 -	A14XER	4	0,9	ZFR6V-G	8894		ZFR6V-G
Corso D 1.6 GSI		1.6	110	05.07 -	Z16LEL	4	0,9	ZFR6BP-G	1748		ZFR6BP-G
Corso D 1.6 Turbo		1.6	110	02.07 -	Z16LEL	4	0,9	ZFR6BP-G	1748		ZFR6BP-G
Corso D 1.6 Turbo		1.6	141	11.06 -	A16LER	4	0,9	ZFR6BP-G	1748		ZFR6BP-G
Corso D 1.6 Turbo		1.6	141	11.06 -	Z16LER	4	0,9	ZFR6BP-G	1748		ZFR6BP-G
Corso D 1.6 Turbo		1.6	155	06.11 -	A16LES	4	0,9	ZFR6BP-G	1748		ZFR6BP-G
Corso D 1.7 CDTI		1.7	92	07.06 -	Z17DTR	4	█	Y-541J	1983	42	

**FRONTERA A**

Frontera A 2.0		2.0	85	09.91 - 08.95	C20NE OHC II	4		BKR5EK	7956	23	LPG 1
Frontera A 2.0		2.0	85	02.95 - 06.98	X20SE OHC II	4		BKR5EK	7956	23	LPG 1
Frontera A 2.0		2.0	85	02.95 -	X20XE OHC	4		BKR5EK	7956	23	LPG 1
Frontera A 2.2 16V		2.2	100	02.95 - 06.98	X22XE DOHC	4		BKR5EK	7956	23	LPG 1
Frontera A 2,3 TD Intercooler		2.3	74	09.91 - 02.95	23 DTR OHC	4	█	Y-924U	4950	1	
Frontera A 2,3 TD Intercooler		2.3	74	03.92 - 09.95	DTR OHC	4	█	Y-924U	4950	1	
Frontera A 2.4		2.4	92	09.91 - 02.95	C24NE CIH	4	0,7	BPR6HS	7022	3	BPR7HIX
Frontera A 2.5 TDS		2.5	85	06.96 - 08.98	25TD VM41B (25TDS)	4	█	Y-741U	6943	20	
Frontera A 2.5 TDS		2.5	85	09.96 - 10.98	25TD/TDS/OHC	4	█	Y-741U	6943	20	
Frontera A 2.8 TD		2.8	83	02.95 - 11.98	28TD 4JB1T (28TDI)	4	█	Y-904M1	7995		
					Isuzu						

**FRONTERA B**

Frontera B 2.2 16V		2.2	100	10.98 - 12.00	X22SE	4		BKR5EK	7956	23	LPG 1
Frontera B 2.2 16V		2.2	100	10.98 -	X22XE DOHC	4		BKR5EK	7956	23	LPG 1
Frontera B 2.2 DTI 16V		2.2	85	10.98 - 09.02	X22DTH	4	█	Y-748U	6649	14	
Frontera B 2.2 DTI 16V		2.2	85	10.98 - 09.02	Y22DTH	4	█	Y-523J	6298	37	
Frontera B 3.2 V6		3.2	151	08.98 -	Y32NE 6VD1	6	1,1	PFR5G-11	2647		PFR6G-11

**GT**

GT Turbo		2.0	194	11.07 - 01.10	Z20LNF / Z20NHH	4	0,9	ILTR5D	5476		ILTR5D
----------	--	-----	-----	---------------	-----------------	---	-----	--------	------	--	--------

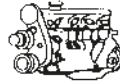

Code *l* kW

Cyl.

Stock-No.  
**VENE**  
BY-PROMERZ

LPG/CNG

**OPEL****INSIGNIA**

Insignia 1.4 Turbo		1.4	103	08.11 -	A14NET	4	0,7	IFR7X7G	91039		IFR7X7G
Insignia 1.6		1.6	85	07.08 -	A16XER	4	1,1	ZFR5F-11	2262		LPG 6
Insignia 1.6 Turbo		1.6	132	07.08 -	A16LET	4	0,9	ZFR6BP-G	1748		ZFR6BP-G
Insignia 1.8		1.8	103	07.08 -	A18XER	4	1,1	ZFR5F-11	2262		LPG 6
Insignia 2.0 Turbo		2.0	162	07.08 -	A20NHT	4	0,9	ILTR5D	5476		
Insignia 2.0 Turbo E85		2.0	162	09.10 -	A20NHT	4	0,9	ILTR5D	5476		
Insignia 2.0 Turbo 4x4		2.0	184	07.11 -	A20NFT	4	0,9	ILTR5D	5476		
Insignia 2.8 V6 Turbo 4x4		2.8	191	07.08 -	A28NET	6	1,0	DILFR7B10G	97218		DILFR7B10G
Insignia 2.8 V6 Turbo 4x4 OPC		2.8	239	07.09 -	A28NER	6	1,0	DILFR7B10G	97218		DILFR7B10G

**MERIVA A**

Meriva A 1.3 CDTI		1.3	55	09.03 -	Z13DTJ	4		Y8003J	97256	62	
Meriva A 1.4		1.4	66	06.05 -	Z14XEP	4	1,1	ZFR5F-11	2262		LPG 6
Meriva A 1.6		1.6	64	05.03 -	Z16SE	4		BKR5EK	7956	23	LPG 1
Meriva A 1.6		1.6	74	05.03 -	Z16XE	4		BKR5EK	7956	23	LPG 1
Meriva A 1.6		1.6	77	01.06 -	Z16XEP	4	1,1	ZFR5F-11	2262		LPG 6
Meriva A 1.6 Turbo OPC		1.6	132	08.05 -	Z16LET	4	0,9	ZFR6BP-G	1748		ZFR6BP-G
Meriva A 1.7 CDTI		1.7	74	09.03 -	Z17DTH	4		Y-541J	1983	42	
Meriva A 1.7 CDTI		1.7	92	09.06 -	Z17DTR	4		Y-541J	1983	42	
Meriva A 1.7 CDTI		1.7	92	01.08 -	A17DTR	4		Y-541J	1983	42	
Meriva A 1.7 DTI		1.7	55	09.03 -	Y17DT	4		Y-541J	1983	42	
Meriva A 1.8		1.8	92	05.03 -	Z18XE	4		BKR5EK	7956	23	LPG 1

**MERIVA B**

Meriva B 1.4		1.4	74	03.10 -	A14XER	4	0,9	ZFR6V-G	8894		ZFR6V-G
Meriva B 1.4		1.4	88	03.10 -	A14NEL	4	0,7	IFR7X7G	91039		IFR7X7G
Meriva B 1.4 LPG		1.4	88	06.11 -	A14NEL	4	0,7	IFR7X7G	91039		IFR7X7G
Meriva B 1.4		1.4	103	03.10 -	A14NET	4	0,7	IFR7X7G	91039		IFR7X7G
Meriva B 1.7 CDTI		1.7	74	03.10 -	A17DT	4		Y-541J	1983	42	

**MOKKA**

Mokka 1.4 4x4		1.4	103	06.12 -	A14NET	4	0,7	IFR7X7G	91039		IFR7X7G
Mokka 1.6		1.6	85	06.12 -	A16XER	4	0,9	ZFR6V-G	8894		ZFR6V-G

**MONTEREY**

Monterey 3.1 TD		3.1	84	11.91 - 02.98	4JG2-TC (3.1 D)	4		Y-719RS1	6900		
Monterey 3.2 24V		3.2	130	04.92 - 12.98	6VDI SOHC	6	0,9	BKR6E	6962	28	LPG 1
Monterey 3.5		3.5	158	02.98 - 07.99	6VE1	6	1,1	BKR5EVX-11	5182		LPG 1

**MOVANO**

Movano 1.9 DTI		1.9	59	09.00 -	F9Q M7	4		Y-732J	5605	4	
Movano 2.2 DTI		2.2	66	09.00 -	G9T C7	4		Y-517J	3319	66	
Movano 2.5 CDTi		2.5	74	08.06 -	G9U 650	4		Y-517J	3319	66	
Movano 2.5 CDTi		2.5	88	08.06 -	G9U 650	4		Y-517J	3319	66	
Movano 2.5 CDTi		2.5	107	08.06 -	G9U 650	4		Y-517J	3319	66	
Movano 2.5 D		2.5	59	10.98 - 10.00	S8U W7	4		Y-910J	3617	3	
Movano 2.5 DTi		2.5	73	10.03 -	G9U 754	4		Y-517J	3319	66	
Movano 2.5 DTi		2.5	84	10.01 -	G9U 720 / 724	4		Y-517J	3319	66	

**OMEGA A**

Omega A 1.8 N		1.8	60	09.86 - 03.94	18NV OHC II	4	0,8	BPR6ES	7822	2	LPG 2
Omega A 1.8 N		1.8	62	09.86 - 03.94	S18NV OHC II	4	0,8	BPR6ES	7822	2	LPG 2
Omega A 1.8		1.8	85	09.86 - 09.92	18SEH OHC II	4	0,8	BPR6ES	7822	2	LPG 2
Omega A 2.0		2.0	74	09.86 - 03.94	20NE	4	0,9	BPR5ES	7422	6	LPG 2
Omega A 2.0		2.0	74	09.86 - 03.94	20NEJ	4		BKR6EK	2288	20	LPG 1

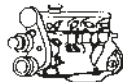
Code *ℓ* kW

Cyl.



Stock-No.



LPG/CNG

**OPEL  
OMEGA A**

Omega A 2.0		2.0	74	04.90 - 02.92	C20NEJ OHC	4		BKR6EK	2288	20	LPG 1
Omega A 2.0 i		2.0	85	09.86 - 03.94	C20NE OHC	4	0,9	BPR5ES	7422	6	LPG 2
Omega A 2.0		2.0	90	09.89 - 03.94	20SE OHC II	4		BKR6EK	2288	20	LPG 1
Omega A 2.3 D		2.3	54	09.86 - 02.94	23 YD OHC	4	<input checked="" type="checkbox"/>	Y-924U	4950	1	
Omega A 2.3 TD		2.3	74	09.88 - 02.94	23 DTR OHC	4	<input checked="" type="checkbox"/>	Y-924U	4950	1	
Omega A 2.4 i		2.4	92	09.88 - 03.94	C24NE CIH	6	0,7	BPR6HS	7022	3	BPR7HIX
Omega A 2.6 i		2.6	110	09.90 - 03.94	C26NE CIH	6	0,7	BPR6HS	7022	3	BPR7HIX
Omega A 3.0 3000		3.0	115	03.87 - 03.94	C30NE CIH	6	0,7	BPR6HS	7022	3	BPR7HIX
Omega A 3.0 3000		3.0	130	03.87 - 03.94	C30NE CIH	6	0,7	BPR6HS	7022	3	BPR7HIX
Omega A 3.0 24V 3000		3.0	147	09.89 - 03.94	C30SE	6		BKR6EK	2288	20	LPG 1
Omega A 3.0 24V 3000		3.0	147	09.90 - 03.94	C30SEJ DOHC	6		BKR6EK	2288	20	LPG 1
Omega A 3.0 24V Evo 500		3.0	170	03.91 - 09.92	C30XEI DOHC	6		BKR6EK	2288	20	LPG 1

**OMEGA B**

Omega B 2.0 DTI 16V		2.0	74	09.99 -	Y20DTH	4	<input checked="" type="checkbox"/>	Y-523J	6298	37	
Omega B 2.0 DTI 16V		2.0	74	10.98 - 09.00	X20DTH OHC	4	<input checked="" type="checkbox"/>	Y-748U	6649	14	
Omega B 2.0 DTI 16V		2.0	74	09.97 -	X20DILC	4	<input checked="" type="checkbox"/>	Y-748U	6649	14	
Omega B 2.0		2.0	85	01.94 - 09.99	20SE OHC	4		BKR5EK	7956	23	LPG 1
Omega B 2.0		2.0	85	01.94 - 09.00	X20SE OHC	4		BKR5EK	7956	23	LPG 1
Omega B 2.0 16V		2.0	100	01.94 - 09.00	X20XE DOHC	4		BKR5EK	7956	23	LPG 1
Omega B 2.2 DTI 16V		2.2	88	08.01 -	Y22DTH	4	<input checked="" type="checkbox"/>	Y-523J	6298	37	
Omega B 2.2 DTI 16V		2.2	88	05.01 -	Y22DTR	4	<input checked="" type="checkbox"/>	Y-523J	6298	37	
Omega B 2.2 16V		2.2	106	09.99 - 09.00	Y22XE	4		BKR5EK	7956	23	LPG 1
Omega B 2.2 16V		2.2	108	08.00 -	Z22XE	4		BKR5EK	7956	23	LPG 1
Omega B 2.5 TD		2.5	96	02.94 - 02.96	U25TD (Mot. BMW)	6	<input checked="" type="checkbox"/>	Y-924J	7906	1	
Omega B 2.5 TD		2.5	96	08.96 - 10.01	X25DT OHC	6	<input checked="" type="checkbox"/>	Y-924J	7906	1	
Omega B 2.5 V6		2.5	125	01.94 - 09.00	X25XE DOHC	6		BKR5EK	7956	23	LPG 1
Omega B 2.6 V6		2.6	132	08.00 - 07.03	Y26SE	6		BKR5EQUA	3566		
Omega B 3.0 V6 24V		3.0	155	09.94 - 10.01	X30XE DOHC	6		BKR5EK	7956	23	LPG 1
Omega B 3.2 V6		3.2	160	05.01 - 07.03	Y32SE	6		BKR5EQUA	3566		

**SENATOR B**

Senator B 2.6 i		2.6	110	09.90 - 09.93	C26NE CIH	6	0,7	BPR6HS	7022	3	BPR7HIX
Senator B 3.0		3.0	150	09.89 - 06.93	C30SE DOHC	6		BKR6EK	2288	20	LPG 1
Senator B 3.6		3.6	145	08.89 - 09.93	C3,6NE irmscher	6	0,7	BPR6HS	7022	3	BPR7HIX
Senator B 3.6		3.6	145	08.89 - 09.93	C3,6NEI irmscher	6	0,7	BPR6HS	7022	3	BPR7HIX
Senator B 4.0 Irmischer		4.0	200	01.91 - 09.93	C40SE irmscher	6	0,7	BPR6HS	7022	3	BPR7HIX

**SIGNUM**

Signum 1.6		1.6	74	03 -	Z16XE DOHC	4		BKR5EQUA	3566		
Signum 1.8		1.8	85	05.03 -	Z18XEL	4		BKR5EQUA	3566		
Signum 1.8		1.8	103	09.05 - 03.07	Z18XER	4	1,1	ZFR5F-11	2262		LPG 6
Signum 1.8		1.8	90	05.03 - 07.05	Z18XE	4		BKR5EQUA	3566		
Signum 1.9 CDTI bis Fgst.-Nr. 71021891		1.9	74	08.05 - 02.08	Z19DTL	4	<input checked="" type="checkbox"/>	Y-534J	3413	36	
Signum 1.9 CDTI ab Fgst.-Nr. 71021892		1.9	74	08.05 - 02.08	Z19DTL	4	<input checked="" type="checkbox"/>	Y1030J	90828	70	
Signum 1.9 CDTI bis Fgst.-Nr. 71021891		1.9	88	04.04 - 10.08	Z19DT	4	<input checked="" type="checkbox"/>	Y-534J	3413	36	
Signum 1.9 CDTI ab Fgst.-Nr. 71021892		1.9	88	04.04 - 10.08	Z19DT	4	<input checked="" type="checkbox"/>	Y1030J	90828	70	
Signum 1.9 CDTI 16V		1.9	110	04.04 - 02.08	Z19DTH	4	<input checked="" type="checkbox"/>	YE07	6092		
Signum 2.0 DTI 16V		2.0	74	05.03 - 04.04	Y20DTH	4	<input checked="" type="checkbox"/>	Y-523J	6298	37	
Signum 2.0 Turbo		2.0	129	05.03 - 12.08	Z20NET	4		PFR6T-10G	5542		PFR6T-10G
Signum 2.2 DTI 16V		2.2	92	05.03 - 04.04	Y22DTR	4	<input checked="" type="checkbox"/>	Y-523J	6298	37	
Signum 2.2		2.2	108	05.03 -	Z22SE	4		LTR6B-10T	5948		LTR6B-10T

Fgst = Chassis No.

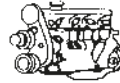
Code *l* kW

Cyl.



Stock-No.



LPG/CNG

**OPEL****SIGNUM**

Signum 2.2 direct		2.2	114	05.03 - 09.08	Z22YH	4		BKR5EQUA	3566		
Signum 2.8 V6 Turbo		2.8	169	09.05 - 12.08	Z28NEL	6	1,0	PLFR6C-10G	1959		PLFR6C-10G
Signum 2.8 V6 Turbo		2.8	184	01.06 - 12.08	Z28NET	6	1,0	DILFR7B10G	97218		DILFR7B10G
Signum 3.2 V6		3.2	155	05.03 - 07.05	Z32SE	6		BKR5EQUA	3566		

**SINTRA**

Sintra 2.2 16V		2.2	104	09.96 - 09.99	X22XE DOHC	4		BKR5EK	7956	23	LPG 1
Sintra 3.0 V6 24V		3.0	155	09.96 - 09.99	X30XE DOHC	6		BKR5EK	7956	23	LPG 1
Sintra 2.2 DTI		2.2	85	01.98 -	X22DTH	4		Y-748U	6649	14	

**SPEEDSTER**

Speedster		2.2	108	04.00 - 06	Z22SE	4		LTR6B-10T	5948		LTR6B-10T
Speedster Turbo		2.0	147	03 -	Z20LET	4		BKR5EK	7956	23	LPG 1

**TIGRA A**

Tigra A 1.4 16V		1.4	63	08.97 - 12.00	C14SEL OHC	4		BKR5EK	7956	23	LPG 1
Tigra A 1.4 16V		1.4	66	08.94 - 12.00	X14XE DOHC	4		BKR5EK	7956	23	LPG 1
Tigra A 1.6 16V		1.6	74	06.97 - 08.98	C16SEL DOHC	4		BKR5EK	7956	23	LPG 1
Tigra A 1.6 16V		1.6	78	08.94 - 08.98	X16XE DOHC	4		BKR5EK	7956	23	LPG 1

**TIGRA B**

Tigra B 1.3 CDTI		1.3	52	06.04 -	Z13DT	4		Y8003J	97256	62	
Tigra B 1.4		1.4	66	06.04 -	Z14XEP	4	1,1	ZFR5F-11	2262		LPG 6
Tigra B 1.8		1.8	92	06.04 -	Z18XE	4	1,1	ZFR5F-11	2262		LPG 6

**VECTRA A**

Vectra A 1.4		1.4	55	09.88 - 09.92	14NV OHC I	4	0,8	BPR6ES	7822	2	LPG 2
Vectra A 1.6		1.6	52	09.93 - 08.95	X16SZ OHC	4		BKR5EK	7956	23	LPG 1
Vectra A 1.6		1.6	55	09.88 - 08.94	C16NZ	4	0,9	BPR5ES	7422	6	LPG 2
Vectra A 1.6		1.6	60	09.88 - 09.92	16SV OHC I	4	0,8	BPR6ES	7822	2	LPG 2
Vectra A 1.7 D		1.7	42	02.88 - 09.92	17D OHC II	4		Y-924U	4950	1	
Vectra A 1.7 TD		1.7	60	03.90 -	Isuzu	4		Y-743U	5642		
					TC4EC1 817253—>						
Vectra A 1.7 TD		1.7	60	10.92 - 08.95	17DT Isuzu TC4EE1	4		CY03	6160	8	
Vectra A 1.7 TD		1.7	60	10.92 - 08.95	X17DT Isuzu TC4EE1	4		CY03	6160	8	
Vectra A 1.8 S		1.8	65	09.88 - 08.95	E18NVR OHC II	4	0,8	BPR6ES	7822	2	LPG 2
Vectra A 1.8 S 4x4		1.8	65	01.89 - 08.95	E18NVR OHC II	4	0,8	BPR6ES	7822	2	LPG 2
Vectra A 1.8 i		1.8	66	09.89 - 08.95	18SV	4	0,8	BPR6ES	7822	2	LPG 2
Vectra A 1.8 i		1.8	66	09.89 - 08.95	C18SV OHC	4	0,8	BPR6ES	7822	2	LPG 2
Vectra A 1.8 i		1.8	66	03.90 - 08.95	C18NZ OHC II	4		BKR5EK	7956	23	LPG 1
Vectra A 1.8 i 4x4		1.8	66	09.89 - 08.95	18SV	4	0,8	BPR6ES	7822	2	LPG 2
Vectra A 1.8 i 4x4		1.8	66	09.89 - 08.95	C18SV OHC	4	0,8	BPR6ES	7822	2	LPG 2
Vectra A 2.0 i		2.0	85	09.89 - 08.95	20NE	4		BKR5EK	7956	23	LPG 1
Vectra A 2.0 i		2.0	85	09.89 - 08.95	C20NE OHC	4		BKR5EK	7956	23	LPG 1
Vectra A 2.0 i 4x4		2.0	85	01.89 - 08.95	20NE	4		BKR5EK	7956	23	LPG 1
Vectra A 2.0 i 4x4		2.0	85	01.89 - 08.95	C20NE OHC	4		BKR5EK	7956	23	LPG 1
Vectra A 2.0 i		2.0	95	09.88 - 09.92	20SEH OHC II	4	0,8	BPR6ES	7822	2	LPG 2
Vectra A 2.0 i 4x4		2.0	95	01.89 - 09.92	20SEH OHC II	4	0,8	BPR6ES	7822	2	LPG 2
Vectra A 2.0 i 16V		2.0	100	08.92 - 08.95	20XE	4		BKR5EK	7956	23	LPG 1
Vectra A 2.0 i 16V		2.0	100	08.92 - 08.95	C20XE	4		BKR5EK	7956	23	LPG 1
Vectra A 2.0 i 16V		2.0	100	08.92 - 08.95	C20XE-LN	4		BKR5EK	7956	23	LPG 1
Vectra A 2.0 i 16V		2.0	100	12.94 - 08.95	X20XEV DOHC	4		BKR5EK	7956	23	LPG 1
Vectra A 2.0 2000 16V		2.0	110	09.89 - 08.92	20XE	4		BKR6EK	2288	20	LPG 1

Code *l* kW

Cyl.



Stock-No.



LPG/CNG

**OPEL  
VECTRA A**

Vectra A 2.0 2000 16V		2.0	110	09.89 - 08.92	C20XE DOHC	4		BKR6EK	2288	20	LPG 1
Vectra A 2.0 2000 16V 4x4		2.0	110	09.89 - 08.92	20XE	4		BKR6EK	2288	20	LPG 1
Vectra A 2.0 2000 16V 4x4		2.0	110	09.89 - 08.92	C20XE DOHC	4		BKR6EK	2288	20	LPG 1
Vectra A 2.0 i Turbo 4x4		2.0	150	09.92 - 08.95	C20LET DOHC	4	1,1	ZFR6F-11	4291		LPG 6
Vectra A 2.5 V6		2.5	125	02.93 - 08.95	25XE	6		BKR5EK	7956	23	LPG 1
Vectra A 2.5 V6		2.5	125	03.93 - 08.95	C25XE DOHC	6		BKR5EK	7956	23	LPG 1

**VECTRA B**

Vectra B 1.6 i		1.6	55	08.95 -	16LZ2 OHC	4		BKR5EK	7956	23	LPG 1
Vectra B 1.6 i		1.6	55	08.95 - 09.00	X16SZR OHC	4		BKR5EK	7956	23	LPG 1
Vectra B 1.6 i 16V		1.6	74	08.95 - 09.00	X16XEL DOHC	4		BKR5EK	7956	23	LPG 1
Vectra B 1.6 i 16V		1.6	74	08.00 - 04.02	Z16XE DOHC	4		BKR5EK	7956	23	LPG 1
Vectra B 1.7 TD		1.7	60	08.95 - 12.98	X17TD / TC4 EE1 Isuzu	4	☑	CY03	6160	8	
Vectra B 1.8 i 16V		1.8	85	08.95 - 09.00	X18XE	4		BKR5EK	7956	23	LPG 1
Vectra B 1.8 i 16V		1.8	85	03.99 - 09.00	X18XE1	4		BKR5EK	7956	23	LPG 1
Vectra B 1.8 i 16V		1.8	85	08.00 - 04.02	Z18XEL	4		BKR5EK	7956	23	LPG 1
Vectra B 1.8 i 16V		1.8	92	08.00 - 04.02	Z18XE	4		BKR5EK	7956	23	LPG 1
Vectra B 2.0 Di		2.0	60	08.96 - 07.99	X20DTL SOHC	4	☑	Y-604J	6157		
Vectra B 2.0 Di		2.0	60	08.99 - 04.02	X20DTL SOHC	4	☑	Y-748U	6649	14	
Vectra B 2.0 DTI 16V		2.0	74	08.97 - 04.02	X20DTH OHC	4	☑	Y-748U	6649	14	
Vectra B 2.0 DTI 16V		2.0	74	09.97 - 07.99	X20DILC	4	☑	Y-748U	6649	14	
Vectra B 2.0 DTI 16V		2.0	74	08.00 - 04.02	Y20DTH	4	☑	Y-523J	6298	37	
Vectra B 2.0		2.0	80	08.95 -	20NEJ OHC	4		BKR5EK	7956	23	LPG 1
Vectra B 2.0 i 16V		2.0	100	08.95 - 09.00	X20XEV	4		BKR5EK	7956	23	LPG 1
Vectra B 2.0 i 16V		2.0	100	02.97 -	C20SEL DOHC	4		BKR5EK	7956	23	LPG 1
Vectra B 2.2 DTI 16V		2.2	92	08.00 - 04.02	Y22DTR	4	☑	Y-523J	6298	37	
Vectra B 2.2 i 16V		2.2	106	10.99 -	C22SEL DOHC	4		BKR5EK	7956	23	LPG 1
Vectra B 2.2 i 16V		2.2	108	08.00 - 04.02	Z22SE	4		LTR6B-10T	5948		LTR6B-10T
Vectra B 2.5 i V6		2.5	125	08.95 - 09.00	X25XE DOHC	6		BKR5EK	7956	23	LPG 1
Vectra B 2.5 i V6		2.6	125	08.00 - 07.03	Y26SE	6		BKR5EQUA	3566		
Vectra B i500		2.5	143	01.98 - 09.00	X25XE DOHC	6		BKR5EK	7956	23	LPG 1

**VECTRA C**

Vectra C 1.6		1.6	74	06.04 - 08.08	Z16XE DOHC	4		BKR5EQUA	3566		
Vectra C 1.6		1.6	77	01.06 - 08.08	Z16XEP	4	1,1	ZFR5F-11	2262		LPG 6
Vectra C 1.8		1.8	81	04.02 - 07.03	Z18XEL	4		BKR5EQUA	3566		
Vectra C 1.8		1.8	103	01.06 - 08.08	Z18XER	4	1,1	ZFR5F-11	2262		LPG 6
Vectra C 1.8		1.8	92	08.02 - 09.05	Z18XE	4		BKR5EQUA	3566		
Vectra C 1.9 CDTI bis Fgst.-Nr. 71021891		1.9	74	06.05 - 08.08	Z19DTL	4	☑	Y-534J	3413	36	
Vectra C 1.9 CDTI ab Fgst.-Nr. 71021892		1.9	74	06.05 - 08.08	Z19DTL	4	☑	Y1030J	90828	70	
Vectra C 1.9 CDTI bis Fgst.-Nr. 71021891		1.9	88	04.04 - 08.08	Z19DT	4	☑	Y-534J	3413	36	
Vectra C 1.9 CDTI ab Fgst.-Nr. 71021892		1.9	88	04.04 - 08.08	Z19DT	4	☑	Y1030J	90828	70	
Vectra C 1.9 CDTI 16V		1.9	110	04.04 - 08.08	Z19DTH	4	☑	YE07	6092		
Vectra C 2.0 DTI 16V		2.0	74	04.02 - 08.05	Y20DTH	4	☑	Y-523J	6298	37	
Vectra C 2.0 16V Turbo		2.0	129	03.03 - 08.08	Z20NET	4		PFR6T-10G	5542		PFR6T-10G
Vectra C 2.2 DTI 16V		2.2	92	04.02 - 07.04	Y22DTR	4	☑	Y-523J	6298	37	
Vectra C 2.2 16V		2.2	108	08.02 - 04.04	Z22SE	4		LTR6B-10T	5948		LTR6B-10T
Vectra C 2.2 direct		2.2	114	10.03 - 08.08	Z22YH	4		BKR5EQUA	3566		
Vectra C 2.8 V6 Turbo		2.8	169	09.05 - 08.08	Z28NEL	6	1,0	PLFR6C-10G	1959		PLFR6C-10G
Vectra C 2.8 V6 Turbo		2.8	184	08.06 - 08.08	Z28NET	6	1,0	PLFR6C-10G	1959		PLFR6C-10G
Vectra C 2.8 V6 Turbo		2.8	188	08.05 - 08.06	Z28NET	6	1,0	PLFR6C-10G	1959		PLFR6C-10G
Vectra C 3.2 V6		3.2	155	08.02 - 07.05	Z32SE	6		BKR5EQUA	3566		

Fgst = Chassis No.

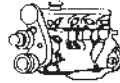
Code *l* kW

Cyl.

Stock-No.  
**VEFINE**  
BY-PROMOTIONS

LPG/CNG

**OPEL****VIVARO**

Vivaro 2.0		2.0	86	08.01 -	F4R 820	4	0,9	PFR6G-9	4377		PFR7G
Vivaro 12.0 6V		2.0	88	09.01 -	F4R 720	4	0,9	PFR6G-9	4377		PFR7G
Vivaro 2.5 CDTI		2.5	84	08.06 -	G9U 720 / 730	4	█	Y-517J	3319	66	
Vivaro 2.5 CDTI		2.5	107	08.06 -	G9U 630	4	█	Y-517J	3319	66	
Vivaro 1.9 DI		1.9	60	09.01 -		4	█	Y-732J	5605	4	
Vivaro 1.9 DTI		1.9	74	09.01 -	F9Q 760	4	█	Y-732J	5605	4	
Vivaro 2.5 DTI		2.5	98	05.03 -	G9U 730	4	█	Y-517J	3319	66	

**ZAFIRA A**

Zafira A 1.6 16V		1.6	74	03.99 -	X16XE DOHC	4		BKR5EK	7956	23	LPG 1
Zafira A 1.6 16V		1.6	74	08.00 -	Z16XE	4		BKR5EK	7956	23	LPG 1
Zafira A 1.6 CNG		1.6	71	09.01 -	Z16YNG	4		LPG 1	1496		LPG 1
Zafira A 1.8 16V		1.8	85	03.99 - 09.00	X18XE DOHC	4		BKR5EK	7956	23	LPG 1
Zafira A 1.8 16V		1.8	85	04.99 - 09.00	X18XE1	4		BKR5EK	7956	23	LPG 1
Zafira A 1.8 16V		1.8	92	09.00 -	Z18XE	4		BKR5EK	7956	23	LPG 1
Zafira A 2.0 DI		2.0	60	09.99 - 11.00	X20DTL	4	█	Y-748U	6649	14	
Zafira A 2.0 DTI		2.0	74	04.99 -	X20DILC	4	█	Y-748U	6649	14	
Zafira A 2.0 DTI		2.0	74	08.99 -	Y20DTL	4	█	Y-748U	6649	14	
Zafira A 2.0 DTI		2.0	74	08.00 -	Y20DTH	4	█	Y-523J	6298	37	
Zafira A 2.0 Turbo OPC		2.0	141	01 -	Z20LET	4		BKR5EK	7956	23	LPG 1
Zafira A 2.2		2.2	108	08.00 - 06	Z22SE	4		LTR6B-10T	5948		LTR6B-10T
Zafira A 2.2 DTI		2.2	92	01.02 - 06.05	Y22DTR	4	█	Y-523J	6298	37	

**ZAFIRA B**

Zafira B 1.6 CNG		1.6	69	05 -	Y16YNG	4		LPG 1	1496		LPG 1
Zafira B 1.6 16V		1.6	77	07.05 -	Z16XEP	4	1,1	ZFR5F-11	2262		LPG 6
Zafira B 1.6 16V		1.6	85	01.08 -	Z16XER	4	1,1	ZFR5F-11	2262		LPG 6
Zafira B 1.6 16V		1.6	85	01.08 -	A16XER	4	0,9	ZFR6V-G	8894		ZFR6V-G
Zafira B 1.7 CDTI		1.7	81	01.08 -	A17DTJ	4	█	Y-541J	1983	42	
Zafira B 1.7 CDTI		1.7	92	01.08 -	A17DTR	4	█	Y-541J	1983	42	
Zafira B 1.8 16V		1.8	103	07.05 -	Z18XER	4	1,1	ZFR5F-11	2262		LPG 6
Zafira B 1.9 CDTI bis Fgst.-Nr. 62999999		1.9	74	07.05 -	Z19DTL	4	█	Y-534J	3413	36	
Zafira B 1.9 CDTI ab Fgst.-Nr. 72000001		1.9	74	07.05 -	Z19DTL	4	█	Y1030J	90828	70	
Zafira B 1.9 CDTI bis Fgst.-Nr. 62999999		1.9	88	07.05 -	Z19DT	4	█	Y-534J	3413	36	
Zafira B 1.9 CDTI ab Fgst.-Nr. 72000001		1.9	88	07.05 -	Z19DT	4	█	Y1030J	90828	70	
Zafira B 1.9 CDTI		1.9	110	07.05 -	Z19DTH	4	█	YE07	6092		
Zafira B 2.0 Turbo		2.0	147	07.05 -	Z20LER	4	0,7	ZFR5F	5165		LPG 6
Zafira B 2.0 Turbo OPC		2.0	177	09.05 -	Z20LEH	4		PFR6T-G	6314		PFR6T-G
Zafira B 2.2 DI		2.2	110	07.05 -	Z22YH	4		BKR5EQUA	3566		

**ZAFIRA TOURER**

Zafira Tourer 1.4		1.4	88	10.11 -	A14NEL	4	0,7	IFR7X7G	91039		IFR7X7G
Zafira Tourer 1.4		1.4	103	10.11 -	A14NET	4	0,7	IFR7X7G	91039		IFR7X7G
Zafira Tourer 1.8		1.8	103	12.11 -	A18XER	4	0,9	ZFR6V-G	8894		ZFR6V-G

**PEUGEOT****106 1.VERSION**

106 XN		0.9	37	08.91 - 12.92	TU9-C1A	4	0,8	BCP5ES	7496	16	LPG 3
106i XN, XA, Kid		0.9	37	07.92 - 06.95	TU9M-CDZ	4	0,8	BCPR5ES	6130	32	LPG 3
106i XN, XA, Kid		0.9	37	07.95 - 03.96	TU9M-CDZ	4		BKR5EK	7956	23	LPG 1
106 XN, XR		1.1	38	08.91 - 12.92	TU1-H1A	4	0,8	BCP5ES	7496	16	LPG 3
106i XN, XR, XT, Green		1.1	44	07.92 - 06.95	TU1M-HDZ	4	0,8	BCPR5ES	6130	32	LPG 3
106i XN, XR, XT, Green		1.1	44	07.95 - 03.96	TU1M-HDZ	4		BKR6EK	2288	20	LPG 1
106 Rallye		1.3	74	11.93 - 03.96	TU2J2-MFZ	4		BKR6EK	2288	20	LPG 1

Fgst = Chassis No.

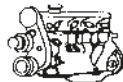

Code *l* kW

Cyl.



Stock-No.



LPG/CNG

**PEUGEOT  
106 1.VERSION**

106 D		1.4	37	08.91 - 06.94	TUD3/L	4		Y-910J	3617	3	
106 XR, XT		1.4	51	08.91 - 12.92	TU3.2-K2D	4	0,7	BCP6ES	4930	17	LPG 3
106 Xsi		1.4	55	08.91 - 12.92	TU3JP~KFX	4		BKR6EK	2288	20	LPG 1
106 Xsi		1.4	55	07.92 - 03.96	TU3JP cat.~KFX	4		BKR6EK	2288	20	LPG 1
106i XR, XS, XT		1.4	55	07.92 - 06.95	TU3MC~KDX	4	0,8	BCPR5ES	6130	32	LPG 3
106i XR, XS, XT		1.4	55	07.95 - 03.96	TU3MC~KDX	4		BKR6EK	2288	20	LPG 1
106 D		1.5	42	07.94 - 03.96	TUD5	4		Y-503J	1009	10	
106 D		1.5	42	04.96 - 10.03	TUD5	4		Y-503J	1009	10	
106i XS, XT, Griffes		1.6	66	07.94 - 03.96	TU5JP~NFZ	4		BKR6EK	2288	20	LPG 1
106 Xsi		1.6	74	12.93 - 06.95	TU5J2~NFW	4	0,8	BKR6ES	3783	28	LPG 1
106 Xsi		1.6	74	07.95 - 05.96	TU5J2~NFW	4		BKR6EK	2288	20	LPG 1

**106 2.VERSION**

106i		1.0	37	04.96 -	TU9M~CDZ /Y	4		BKR5EK	7956	23	LPG 1
106i		1.1	44	04.96 -	TU1M+ ~HDZ	4		BKR6EK	2288	20	LPG 1
106		1.1	44	05.00 -	TU1JP	4	0,9	BKR6EZ	4619	38	LPG 1
106i		1.4	55	04.96 - 12.99	TU3JP~KFX	4		BKR6EK	2288	20	LPG 1
106i		1.4	55	01.00 -	TU3JP~KFX	4	0,9	BKR6EZ	4619	38	LPG 1
106i		1.6	66	04.96 - 12.99	TU5JP~NFZ	4		BKR6EK	2288	20	LPG 1
106i		1.6	66	01.00 -	TU5JP~NFZ	4	0,9	BKR6EZ	4619	38	LPG 1
106 Rallye		1.6	74	06.96 -	TU5J2~NFW	4		BKR6EK	2288	20	LPG 1
106 S16, Gti		1.6	88	06.96 - 12.99	TU5J4~NFX	4		BKR6EK	2288	20	LPG 1
106 S16, Gti		1.6	88	01.00 -	TU5J4~NFX	4	0,9	BKR6EZ	4619	38	LPG 1

**107**

107 12V		1.0	50	06.05 -		3	1,1	LFRC-11	5788		
107 Hdi		1.4	51	01.05 -	DV4	4		YE05	91322	73	
107 Hdi		1.4	51	01.05 -	DV4TD	4		YE04	1684	40	

**205**

205 XE, GL, Junior		0.9	33	07.87 - 12.92	TU9	4	0,8	BCP5ES	7496	16	LPG 3
205 XE, GL, Junior		0.9	33	07.92 -	TU9M Cat.	4	0,8	BCPR5ES	6130	32	LPG 3
205 XR, XL, GL, GR		1.1	34	07.87 - 12.92	TU1	4	0,8	BCP5ES	7496	16	LPG 3
205		1.1	44	- 06.92		4	0,8	BCPR6ES	2330	12	LPG 3
205 GR, Color Line		1.1	44	07.92 - 06.95	TU1M Cat.	4	0,8	BCPR5ES	6130	32	LPG 3
205 GR, Color, Sacre Num		1.1	44	03.95 -	TU1.M Cat.	4		BKR6EK	2288	20	LPG 1
205 Rallye		1.3	75	03.88 - 06.92	TU2.4	4		BKUR7ET	7873		PFR7Q
205 XR, GR, SR, CJ		1.4	43	07.87 - 12.92	TU3, TU3A	4	0,8	BCP5ES	7496	16	LPG 3
205 XR, GR, SR, CJ		1.4	55	07.92 -	TU3FM Cat.	4	0,8	BCPR5ES	6130	32	LPG 3
205 XR, XS		1.4	55	07.92 - 06.95	TU3MC Cat.	4	0,8	BCPR6ES	2330	12	LPG 3
205 XR, GR, SR, SJ, Sacre N°		1.4	55	07.95 -	TU3.MC Cat.	4		BKR6EK	2288	20	LPG 1
205 XT, XS, GT, CT		1.4	62	07.87 - 12.92	TU3S	4	0,7	BCP6ES	4930	17	LPG 3
205 Rallye		1.4		03.88 - 06.92	TU2.4	4		BKUR7ET	7873		PFR7Q
205 XS, GT, Auto		1.6	65	07.92 -	XU5.M Cat.	4	0,8	BCPR5ES	6130	32	LPG 3
205 GTi / CTi		1.6	83	07.87 - 06.92	XU5JA	4	0,7	BCP6ES	4930	17	LPG 3
205 GR, XS, XT, Auto		1.6		07.90 - 12.92	XU5.1C	4	0,7	BCP6ES	4930	17	LPG 3
205 D		1.8	44	10.83 - 08.98	XUD7	4		Y-924J	7906	1	
205 D		1.8	44	09.98 - 12.99	XUD7	4		Y-938R	5267	1	
205 TD		1.8	58	07.85 - 08.98	XUD7T	4		Y-924J	7906	1	
205		1.8	58	09.98 - 12.99	XUD7T	4		Y-938R	5267	1	
205 D		1.9	47	10.87 - 08.98	XUD9	4		Y-924J	7906	1	
205		1.9	51	09.98 - 12.99	XUD9A	4		Y-938R	5267	1	
205 Gentry		1.9	75	07.92 -	XU9.J1 Cat.	4	0,8	BCPR5ES	6130	32	LPG 3

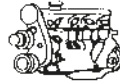
Code *l* kW

Cyl.

Stock-No.  
**VEFINE**  
E6-P0100200

LPG/CNG

**PEUGEOT****205**

205 GTi		1.9	88	07.92 -	XU9.JA Cat.	4	0,8	BCPR5ES	6130	32	LPG 3
205 GTi / Gentry		1.9	94	- 12.92	XU9.JA	4	0,7	BGP6ES	4930	17	LPG 3

**206**

206		1.1	44	09.98 - 12.99	TU1JP-HFZ, HFY	4		BKR6EK	2288	20	LPG 1
206		1.1	44	01.00 -	TU1JP-HFZ; HFY	4	0,9	BKR6EZ	4619	38	LPG 1
206 & SW		1.4	51	12.04 -	DV4TD	4		YE05	91322	73	
206		1.4	55	09.98 - 12.99	TU3JP-KFX	4		BKR6EK	2288	20	LPG 1
206		1.4	55	01.00 -	TU3JP-KFX	4	0,9	BKR6EZ	4619	38	LPG 1
206		1.6	66	09.98 - 08.00	TU5JP-NFZ	4		BKR6EK	2288	20	LPG 1
206		1.6	66	01.00 -	TU5JP-NFZ	4	0,9	BKR6EZ	4619	38	LPG 1
206 16V CC		1.6	81	03.01 -	TU5JP4-NFU	4	0,9	LFR6B	6677		LPG 7
206 Coupé 16V XS, XT		1.6	81	03.01 -	TU5JP4	4	0,9	LFR6B	6677		LPG 7
206 D		1.9	51	09.98 -	DW8/ DW8B	4		Y-503R	4279	10	
206 & SW Hdi		2.0	66	10.99 -	DW10TD	4		Y-504J	1441	24	
206 S16,GT,CC		2.0	101	04.99 -	EW10J4	4	0,9	LFR5B	7113		LPG 7
206 Coupé 16V		2.0	102	04.99 -	EW10J4	4	0,9	LFR5B	7113		LPG 7
206 2.0 S16 RC		2.0	132	10.02 -	EW10J4S- RFK	4	0,9	LFR6B	6677		LPG 7
206 S16		2.0	132	10.02 -	EW10J4S~RFK	4	0,9	LFR6B	6677		LPG 7

**206 SW**

206 SW		1.1	44	09.98 - 12.99	TU1JP~HFZ, HFY	4		BKR6EK	2288	20	LPG 1
206 SW		1.1	44	01.00 -	TU1JP~HFZ, HFY	4	0,9	BKR6EZ	4619	38	LPG 1
206 SW Hdi		1.4	51	09.01 - 12.04	DV4TD	4		YE04	1684	40	
206 SW		1.4	55	09.98 - 12.99	TU3JP~KFX	4		BKR6EK	2288	20	LPG 1
206 SW		1.4	55	01.00 -	TU3JP~KFX	4	0,9	BKR6EZ	4619	38	LPG 1
206 SW		1.4	66	04 -	ET3J4~KFU	4	0,8	LZKAR7A	6799		
206 SW		1.6	66	09.98 - 12.99	TU5JP~NFZ	4		BKR6EK	2288	20	LPG 1
206 SW		1.6	66	01.00 -	TU5JP~NFZ	4	0,9	BKR6EZ	4619	38	LPG 1
206 SW 16V		1.6	81	03.01 -	TU5JP4~NFU	4	0,9	LFR6B	6677		LPG 7
206 SW Hdi		1.6	81	04 - 06.06	DV6TED4	4		YE04	1684	40	
206 SW S16		2.0	101	04.99 -	EW10J4-RFR, RFN	4	0,9	LFR5B	7113		LPG 7

**207**

207 Hdi		1.4	51	07.06 -	DV4TD	4		YE04	1684	40	
207		1.4	55	05.06 -	TU3A-KFV	4	0,9	BKR6EZ	4619	38	LPG 1
207 16V		1.4	55	07 -	EP3	4	0,8	PLZKBR7A-G	5843		PLZKBR7A-G
207 16V		1.4	66	04.06 -	ET3J4-KFU	4	0,8	LZKAR7A	6799		
207 1.4 Vti 95		1.4	70	10.07 -	EP3 / EP3C	4	0,8	PLZKBR7A-G	5843		PLZKBR7A-G
207 Hdi		1.6	66	07.06 -	DV6TD	4		YE04	1684	40	
207 1.6 Hdi 90		1.6	66	06.07 -	DV6ATED4	4		YE05	91322	73	
207 16V		1.6	75	04.06 -	EP6	4	0,8	PLZKBR7A-G	5843		PLZKBR7A-G
207 & SW		1.6	80	06.07 -	DV6TED4	4		YE05	91322	73	
207 Hdi		1.6	81	07.06 -	DV6	4		YE05	91322	73	
207 Hdi 16V		1.6	81	07.06 -	DV6TED4	4		YE04	1684	40	
207 1.6 Hdi 110		1.6	82	08.09 -	DV6C	4		Y8001AS	8904	58	
207 1.6 Vti 120		1.6	88	02.07 -	EP6 / EP6C	4	0,8	PLZKBR7A-G	5843		PLZKBR7A-G
207 1.6 16V		1.6	110	06.06 -	EP6DT	4	0,8	PLZKBR7A-G	5843		PLZKBR7A-G
207		1.6	110	07 -	EP6DT	4	0,8	PLZKBR7A-G	5843		PLZKBR7A-G
207 1.6 THP 155		1.6	115	10.09 -	EP6DT / EP6CDT	4	0,8	PLZKBR7A-G	5843		PLZKBR7A-G
207		1.6	129	11.06 -	EP6DTS	4	0,8	PLZKBR7A-G	5843		PLZKBR7A-G
207 RC		1.6	129	04.07 -	EP6DTS	4	0,8	PLZKBR7A-G	5843		PLZKBR7A-G

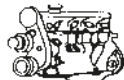
Code *l* kW

Cyl.



Stock-No.



LPG/CNG

**PEUGEOT****208**

208 1.0 68 VTi		1.0	50	03.12 -	EB0	3	1,0	LZKR6AI-10G	97999		
208 1.2 82 VTi		1.2	60	03.12 -	EB2	3	1,0	LZKR6AI-10G	97999		
208 1.4 95 VTi		1.4	70	03.12 -	EP3C	4	0,8	PLZKBR7A-G	5843		
208 1.6 HDi 92		1.6	68	03.12 -	DV6DTE	4	<input checked="" type="checkbox"/>	Y8001AS	8904	58	
208 1.6 HDi 115		1.6	84	03.12 -	DV6C	4	<input checked="" type="checkbox"/>	Y8001AS	8904	58	
208 1.6 120 VTi		1.6	88	03.12 -	EP6C	4	0,8	PLZKBR7A-G	5843		
208 1.6 155 THP		1.6	115	03.12 -	EP6CDT	4	0,8	PLZKBR7A-G	5843		
208 1.6 Gti		1.6	147	08.12 -	EP6CDTXM	4	0,8	ILZKBR7A-8G	5992		

**301**

301 1.2 72 VTi		1.2	52	12 -	EB2M	3	1,0	LZKR6AI-10G	97999		
----------------	--	-----	----	------	------	---	-----	-------------	-------	--	--

**306**

306		1.1	44	02.93 - 06.95	TU1M-HDZ	4	0,8	BCPR5ES	6130	32	LPG 3
306		1.1	44	07.95 - 04.97	TU1M-HDZ	4		BKR5EK	7956	23	LPG 1
306		1.1		96 -	TU1.M+	4		BKR6EK	2288	20	LPG 1
306		1.4	55	02.93 - 06.95	TU3.MC-KDX	4	0,8	BCPR5ES	6130	32	LPG 3
306		1.4	55	07.95 - 12.03	TU3JP-KFX	4		BKR6EK	2288	20	LPG 1
306		1.4	55	01.00 - 10.03	TU3JP-KFX	4	0,9	BKR6EZ	4619	38	LPG 1
306		1.6	66	02.93 - 12.99	TU5JP-NFZ	4		BKR6EK	2288	20	LPG 1
306		1.6	66	01.00 - 10.03	TU5JP-NFZ	4	0,9	BKR6EZ	4619	38	LPG 1
306		1.8	43	10.93 - 08.98	XUD7	4	<input checked="" type="checkbox"/>	Y-924J	7906	1	
306		1.8	44	09.98 -	XUD7	4	<input checked="" type="checkbox"/>	Y-938R	5267	1	
306 D		1.8	44	09.98 - 07.02	DW8	4	<input checked="" type="checkbox"/>	Y-503R	4279	10	
306 TD		1.8	59	09.98 - 07.02	DW8TD	4	<input checked="" type="checkbox"/>	Y-503R	4279	10	
306		1.8	74	02.93 - 03.95	XU7JP-LFZ	4	0,8	BCPR5ES	6130	32	LPG 3
306		1.8	74	04.95 - 10.03	XU7JP-LFZ	4		BKR5EK	7956	23	LPG 1
306 16V		1.8	81	04.97 - 10.03	XU7JP4-LFY	4		BKR5EK	7956	23	LPG 1
306 D		1.9	51	02.93 - 08.98	XUD9A	4	<input checked="" type="checkbox"/>	Y-924J	7906	1	
306		1.9	51	09.98 - 07.02	DW8	4	<input checked="" type="checkbox"/>	Y-503R	4279	10	
306		1.9	51	09.98 - 12.99	XUD9A/XUD9BSD	4	<input checked="" type="checkbox"/>	Y-938R	5267	1	
306 D		1.9	68	03.93 - 08.98	XUD9TE	4	<input checked="" type="checkbox"/>	Y-923U	3380	1	
306 D		1.9	68	09.98 - 12.99	XUD9TE	4	<input checked="" type="checkbox"/>	Y-938R	5267	1	
306 Hdi		2.0	66	04.99 - 07.02	DW10TD	4	<input checked="" type="checkbox"/>	Y-504J	1441	24	
306 D		2.0	80	09.98 -	DW10TD	4	<input checked="" type="checkbox"/>	Y-504J	1441	24	
306		2.0	89	- 03.97	XU10.J4-RFY	4	0,8	BKR6ES	3783	28	LPG 1
306		2.0	89	02.93 - 03.95	XU10.J2-RFX	4	0,8	BCPR5ES	6130	32	LPG 3
306		2.0	89	04.95 - 04.97	XU10.J2-RFX	4		BKR5EK	7956	23	LPG 1
306		2.0	98	04.97 -	XU10J4R-RFV	4		BKR5EK	7956	23	LPG 1
306 Le Mans		2.0	110	11.93 - 96	XU10J4	4	0,8	BKR6ES	3783	28	LPG 1
306		2.0	120	07.96 - 10.03	XU10J4RS-RFS	4	0,9	BKR5EZ	7642	36	LPG 1
306 2.0 16V		2.0		11.93 - 96	XU10J4	4	0,8	BKR6ES	3783	28	LPG 1

**307**

307 Hdi		1.4	51	01.02 - 12.04	DV4TD	4	<input checked="" type="checkbox"/>	YE04	1684	40	
307 Hdi		1.4	51	01.02 - 12.04	DV4TD	4	<input checked="" type="checkbox"/>	YE04	1684	40	
307		1.4	51	12.04 - 05.05	DV4TD	4	<input checked="" type="checkbox"/>	YE05	91322	73	
307		1.4	55	04.01 - 05.05	TU3JP-KFX	4	0,9	BKR6EZ	4619	38	LPG 1
307 XR		1.4	55	04.01 - 99	TU3JP~KFX	4	0,9	BKR6EZ	4619	38	LPG 1
307 16V		1.4	66	03.04 -	ET3J4 KFU	4	0,8	LZKAR7A	6799		
307 1.6 Hdi		1.6	66	04.05 -	DV6ATED4	4	<input checked="" type="checkbox"/>	YE05	91322	73	
307 Hdi		1.6	68	07.06 -	DV6TD	4	<input checked="" type="checkbox"/>	YE04	1684	40	
307		1.6	81	04.01 -	TU5JP4-NFU	4	0,9	LFR6B	6677		LPG 7

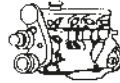
Code *l* kW

Cyl.



Stock-No.

LPG/CNG

**PEUGEOT****307**

307 16V		1.6	81	04.01 -	TU5JP4~NFU	4	0,9	LFR6B	6677		LPG 7
307 Hdi		1.6	81	03.04 - 06.06	DV6TED4	4	█	YE04	1684	40	
307 Hdi		1.6	81	07.06 -		4	█	YE05	91322	73	
307 Hdi		1.6	81	07.06 -	DV6	4	█	YE05	91322	73	
307 Hdi		2.0	66	04.01 -	DW10TD	4	█	Y-504J	1441	24	
307 Hdi		2.0	81	09.01 -	DW10ATED	4	█	Y-504J	1441	24	
307 Hdi		2.0	100	03.04 -	DW10TED	4	█	Y-504J	1441	24	
307 2.0 Hdi		2.0	100	11.03 - 11.07	DW10BTED4	4	█	Y1005J	7957	56	
307 CC 2.0 Hdi		2.0	100	11.03 - 04.09	DW10BTED4	4	█	Y1005J	7957	56	
307 SW 2.0 Hdi		2.0	100	11.03 - 04.08	DW10BTED4	4	█	Y1005J	7957	56	
307		2.0	101	04.01 -	EW10J4-RFN	4	0,9	LFR5B	7113		LPG 7
307 16V		2.0	101	04.01 -	EW10J4-RFN	4	0,9	LFR5B	7113		LPG 7
307 16V		2.0	102	03 -	EW10J4	4	0,9	LFR5B	7113		LPG 7
307		2.0	104	09.06 -	EW10A	4	0,9	LFR5B	7113		LPG 7
307 2.0 16V		2.0	104	09.06 -	EW10A	4	0,9	LFR5B	7113		LPG 7

**308**

308 1.4 16V		1.4	55	09.07 -	EP3	4	0,8	PLZKBR7A-G	5843		PLZKBR7A-G
308 1.4 Vti 95		1.4	70	09.07 -	EP3 / EP3C	4	0,8	PLZKBR7A-G	5843		PLZKBR7A-G
308 1.4 Vti 95		1.4	72	12.09 -	EP3C	4	0,8	PLZKBR7A-G	5843		PLZKBR7A-G
308 1.6 Hdi		1.6	66	09.07 -	DV6TD	4	█	YE05	91322	73	
308 1.6 Hdi		1.6	68	11.09 -	DV6DTED	4	█	Y8001AS	8904	58	
308 1.6 16V		1.6	80	09.07 -	EP6	4	0,8	PLZKBR7A-G	5843		PLZKBR7A-G
308 1.6 Hdi		1.6	80	09.07 -	DV6TED4	4	█	YE05	91322	73	
308 1.6 Hdi 110		1.6	82	12.09 -	DV6CTED4	4	█	Y8001AS	8904	58	
308 1.6 16V		1.6	88	09.07 -	EP6 / EP6C	4	0,8	PLZKBR7A-G	5843		PLZKBR7A-G
308 1.6 16V		1.6	103	09.07 -	EP6DT	4	0,8	PLZKBR7A-G	5843		PLZKBR7A-G
308 1.6 THP 150		1.6	110	09.07 -	EP6DT	4	0,8	PLZKBR7A-G	5843		PLZKBR7A-G
308 1.6 THP 155		1.6	115	07.09 -	EP6CDT	4	0,8	PLZKBR7A-G	5843		PLZKBR7A-G
308 1.6 THP 175		1.6	130	09.07 -	EP6DTS	4	0,8	PLZKBR7A-G	5843		PLZKBR7A-G
308 1.6 GTi		1.6	147	07.10 -	EP6CDTX	4	0,8	ILZKBR7A-8G	5992		ILZKBR7A-8G
308 2.0 Hdi		2.0	100	09.07 -	DW10BTED	4	█	Y1005J	7957	56	
308 2.0 Hdi 140		2.0	103	07.10 -	DW10BTED	4	█	Y1005J	7957	56	
308 2.0 Hdi 165		2.0	120	07.09 -	DW10CTED4	4	█	Y8001AS	8904	58	

**308CC**

308 CC 1.6 THP 16V		1.6	105	03.09 -	EP6DT	4	0,8	PLZKBR7A-G	5843		PLZKBR7A-G
308 CC 1.6 THP 16V		1.6	110	03.09 -	EP6DT	4	0,8	PLZKBR7A-G	5843		PLZKBR7A-G
308 CC 1.6 THP 200		1.6	147	10.10 -	EP6CDTX	4	0,8	ILZKBR7A-8G	5992		ILZKBR7A-8G
308 CC 2.0 Hdi 165		2.0	120	06.09 -	DW10CTED4	4	█	Y8001AS	8904	58	

**309**

309 GE, GL, GR		1.1	40	- 12.92	E1A	4	0,8	BCP5ES	7496	16	LPG 3
309 XA, XR, XL		1.1	40	- 12.92	E1A	4	0,8	BCP5ES	7496	16	LPG 3
309 XE, GE		1.1	40	- 12.92	TU1	4	0,8	BCP5ES	7496	16	LPG 3
309 Vital		1.1	40	07.92 -	TU1M Cat.	4	0,8	BCPR5ES	6130	32	LPG 3
309 GE, GL, GR, XE, XL, XR, XA		1.3	47	10.86 - 12.93	G1A	4	0,8	BCP5ES	7496	16	LPG 3
309 XL, GL		1.4	44	10.86 - 12.93	TU3	4	0,8	BCP5ES	7496	16	LPG 3
309 GRX		1.4	55	10.86 - 12.93	TU3M Cat.	4	0,8	BCPR5ES	6130	32	LPG 3
309		1.5	42	03.94 - 12.95	TUD5	4	█	Y-503J	1009	10	
309 SR, GRX		1.6	65	07.92 -	XU5M Cat.	4	0,8	BCPR5ES	6130	32	LPG 3
309 GR, GRX, SR, SX, XS, XR		1.6	68	07.89 - 12.92	XU5.2C	4	0,7	BCP6ES	4930	17	LPG 3
309 D		1.8	44	06.86 - 12.93	XUD7	4	█	Y-924J	7906	1	

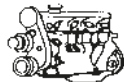
Code *l* kW

Cyl.

Stock-No.  
**VLINE**  
10-11-12-13-14-15-16-17-18-19-20-21-22-23-24-25-26-27-28-29-30-31-32-33-34-35-36-37-38-39-40-41-42-43-44-45-46-47-48-49-50-51-52-53-54-55-56-57-58-59-60-61-62-63-64-65-66-67-68-69-70-71-72-73-74-75-76-77-78-79-80-81-82-83-84-85-86-87-88-89-90-91-92-93-94-95-96-97-98-99-100-101-102-103-104-105-106-107-108-109-110-111-112-113-114-115-116-117-118-119-120-121-122-123-124-125-126-127-128-129-130-131-132-133-134-135-136-137-138-139-140-141-142-143-144-145-146-147-148-149-150-151-152-153-154-155-156-157-158-159-160-161-162-163-164-165-166-167-168-169-170-171-172-173-174-175-176-177-178-179-180-181-182-183-184-185-186-187-188-189-190-191-192-193-194-195-196-197-198-199-200-201-202-203-204-205-206-207-208-209-210-211-212-213-214-215-216-217-218-219-220-221-222-223-224-225-226-227-228-229-230-231-232-233-234-235-236-237-238-239-240-241-242-243-244-245-246-247-248-249-250-251-252-253-254-255-256-257-258-259-260-261-262-263-264-265-266-267-268-269-270-271-272-273-274-275-276-277-278-279-280-281-282-283-284-285-286-287-288-289-290-291-292-293-294-295-296-297-298-299-300-301-302-303-304-305-306-307-308-309-310-311-312-313-314-315-316-317-318-319-320-321-322-323-324-325-326-327-328-329-330-331-332-333-334-335-336-337-338-339-340-341-342-343-344-345-346-347-348-349-350-351-352-353-354-355-356-357-358-359-360-361-362-363-364-365-366-367-368-369-370-371-372-373-374-375-376-377-378-379-380-381-382-383-384-385-386-387-388-389-390-391-392-393-394-395-396-397-398-399-400-401-402-403-404-405-406-407-408-409-410-411-412-413-414-415-416-417-418-419-420-421-422-423-424-425-426-427-428-429-430-431-432-433-434-435-436-437-438-439-440-441-442-443-444-445-446-447-448-449-450-451-452-453-454-455-456-457-458-459-460-461-462-463-464-465-466-467-468-469-470-471-472-473-474-475-476-477-478-479-480-481-482-483-484-485-486-487-488-489-490-491-492-493-494-495-496-497-498-499-500-501-502-503-504-505-506-507-508-509-510-511-512-513-514-515-516-517-518-519-520-521-522-523-524-525-526-527-528-529-530-531-532-533-534-535-536-537-538-539-540-541-542-543-544-545-546-547-548-549-550-551-552-553-554-555-556-557-558-559-560-561-562-563-564-565-566-567-568-569-570-571-572-573-574-575-576-577-578-579-580-581-582-583-584-585-586-587-588-589-590-591-592-593-594-595-596-597-598-599-600-601-602-603-604-605-606-607-608-609-610-611-612-613-614-615-616-617-618-619-620-621-622-623-624-625-626-627-628-629-630-631-632-633-634-635-636-637-638-639-640-641-642-643-644-645-646-647-648-649-650-651-652-653-654-655-656-657-658-659-660-661-662-663-664-665-666-667-668-669-670-671-672-673-674-675-676-677-678-679-680-681-682-683-684-685-686-687-688-689-690-691-692-693-694-695-696-697-698-699-700-701-702-703-704-705-706-707-708-709-710-711-712-713-714-715-716-717-718-719-720-721-722-723-724-725-726-727-728-729-730-731-732-733-734-735-736-737-738-739-740-741-742-743-744-745-746-747-748-749-750-751-752-753-754-755-756-757-758-759-760-761-762-763-764-765-766-767-768-769-770-771-772-773-774-775-776-777-778-779-780-781-782-783-784-785-786-787-788-789-790-791-792-793-794-795-796-797-798-799-800-801-802-803-804-805-806-807-808-809-810-811-812-813-814-815-816-817-818-819-820-821-822-823-824-825-826-827-828-829-830-831-832-833-834-835-836-837-838-839-840-841-842-843-844-845-846-847-848-849-850-851-852-853-854-855-856-857-858-859-860-861-862-863-864-865-866-867-868-869-870-871-872-873-874-875-876-877-878-879-880-881-882-883-884-885-886-887-888-889-890-891-892-893-894-895-896-897-898-899-900-901-902-903-904-905-906-907-908-909-910-911-912-913-914-915-916-917-918-919-920-921-922-923-924-925-926-927-928-929-930-931-932-933-934-935-936-937-938-939-940-941-942-943-944-945-946-947-948-949-950-951-952-953-954-955-956-957-958-959-960-961-962-963-964-965-966-967-968-969-970-971-972-973-974-975-976-977-978-979-980-981-982-983-984-985-986-987-988-989-990-991-992-993-994-995-996-997-998-999-1000

LPG/CNG

**PEUGEOT****309**

309 TD		1.8	58	11.89 - 12.93	XUD7T	4	☑	Y-924J	7906	1	
309 D		1.9	47	06.86 - 12.93	XUD9 / XUD9Y	4	☑	Y-924J	7906	1	
309 XS, SX		1.9	80	07.89 - 06.92	XU9.2C	4	0,7	BCP6ES	4930	17	LPG 3
309 XS, SX		1.9	80	07.92 -	XU9M Cat.	4	0,8	BCPR5ES	6130	32	LPG 3
309 GTi		1.9	88	07.92 -	XU9.JA Cat.	4	0,8	BCPR5ES	6130	32	LPG 3
309 GTi		1.9	94	- 12.92	XU9.JA	4	0,7	BCP6ES	4930	17	LPG 3
309 GTi 16V		1.9	110	07.92 -	XU9.J4 Cat.	4		BCPR6ET	2197		LPG 3
309 GTi 16V		1.9	118	- 06.92	XU9.J4	4		BCP6ET	4563		LPG 3

**405**

405 GL		1.4	47	07.87 - 06.92	TU3	4	0,8	BCP5ES	7496	16	LPG 3
405 GL		1.4	55	07.92 - 06.95	TU3M-KDX Cat.	4	0,8	BCPR5ES	6130	32	LPG 3
405		1.4	55	07.95 - 04.97	TU3M-KDX Cat.	4		BKR6EK	2288	20	LPG 1
405 GL,GR,SR		1.6	55	07.87 - 06.92	XU51C	4	0,8	BCP5ES	7496	16	LPG 3
405 GL,GR,SR		1.6	65	07.92 - 06.94	XU5M-BDY Cat.	4	0,8	BCPR5ES	6130	32	LPG 3
405		1.6	66	04.95 -	XU5JP-BFZ	4		BKR5EK	7956	23	LPG 1
405 Sillage,Style		1.6		07.94 - 03.95	XU5JP-BFZ Cat.	4	0,8	BCPR5ES	6130	32	LPG 3
405 TD		1.8	68	03.88 - 12.92	XUD7TE	4	☑	Y-924J	7906	1	
405 Signa, Style		1.8	74	07.92 - 03.95	XU7JP-LFZ Cat.	4	0,8	BCPR5ES	6130	32	LPG 3
405		1.8		04.95 -	XU7JP-LFZ	4		BKR5EK	7956	23	LPG 1
405 GLD		1.9	47	07.88 - 12.92	XUD9Y	4	☑	Y-924J	7906	1	
405 D		1.9	51	03.88 -	XUD9A	4	☑	Y-924J	7906	1	
405		1.9	51	09.98 - 12.99	XUD9A	4	☑	Y-938R	5267	1	
405		1.9	55	10.95 -	XUD9SD	4	☑	Y-923U	3380	1	
405 TD		1.9	68	09.92 - 12.97	XUD9TE / XUD9TF	4	☑	Y-923U	3380	1	
405 GR,SR		1.9		07.87 - 06.92	XU92C	4	0,7	BCP6ES	4930	17	LPG 3
405 GRi, SRi, Si, X4		1.9		07.87 - 06.92	XU9J2-D6A	4	0,7	BCP6ES	4930	17	LPG 3
405 MI16,X4		1.9		07.90 - 06.92	XU9J4-D6C	4		BCPR6ET	2197		LPG 3
405 Signature, STI		2.0	90	07.92 - 03.95	XU10J2-RFX Cat.	4		BKR5EK	7956	23	LPG 1
405 Mi16		2.0	110	07.92 -	XU10J4-RFY Cat.	4	0,8	BKR6ES	3783	28	LPG 1
405 T16		2.0	147	09.92 - 04.97	XU10J4TE-RGZ Cat.	4		BKR6EK	2288	20	LPG 1
405 Signature,STI		2.0		07.92 - 03.95	XU10J2-RFX Cat.	4	0,8	BCPR5ES	6130	32	LPG 3

**406**

406		1.6	66	10.95 - 06.04	XU5JP-BFZ	4		BKR5EK	7956	23	LPG 1
406		1.8	66	10.95 - 06.04	XU7JP-L6A	4		BKR5EK	7956	23	LPG 1
406		1.8	81	10.95 - 06.04	XU7JP4-LFY	4		BKR5EK	7956	23	LPG 1
406 TD		1.9	68	10.95 - 08.98	XUD9TE/TF/BTF	4	☑	Y-923U	3380	1	
406		1.9	68	09.98 - 12.99	XUD9TE /TF/BTF	4	☑	Y-938R	5267	1	
406 Hdi		2.0	81	12.98 - 04.04	DW10ATED	4	☑	Y-504J	1441	24	
406		2.0	97	10.95 - 06.04	XU10J4R-RFV	4		BKR5EK	7956	23	LPG 1
406 Coupé 16V		2.0	97	06.97 - 03.99	XU10J4R-RFV	4		BKR5EK	7956	23	LPG 1
406 Coupé 16V		2.0	101	04.99 - 02.05	EW10J4-RFR	4	0,9	LFR5B	7113		LPG 7
406		2.0	107	07.96 - 03.99	XU10J2TE-RGX	4		BKR6EK	2288	20	LPG 1
406 TD		2.1	80	10.95 - 08.98	XUD11BTE	4	☑	Y-923U	3380	1	
406		2.1	80	09.98 - 12.99	XUD11BTE	4	☑	Y-938R	5267	1	
406 Coupé Hdi		2.2	100	03.01 -	DW12TED4	4	☑	Y-504J	1441	24	
406 Coupé 16V		2.2	118	05.00 - 02.05	EW12J4-3FZ	4	0,9	LFR5B	7113		LPG 7
406 24V V6		3.0	140	10.96 - 02.05	ES9J4-XFZ	6		BKR6EK	2288	20	LPG 1
406 Coupé V6		3.0	143	06.97 - 02.05	ES9J4-XFZ	6		BKR6EK	2288	20	LPG 1
406 Coupé V6		3.0	154	06.00 - 11.04	ES9J4S-XFX	6	1,1	PLFR5A-11	6240		LPG 7

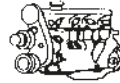

Code *l* kW

Cyl.



Stock-No.



LPG/CNG

**PEUGEOT****406 PHASE 2**

406 Phase 2		1.8	66	04.99 - 02.05	XU7JB-LFX	4		BKR6EK	2288	20	LPG 1
406 Phase 2		1.8	81	04.99 - 06.04	XU7JP4-LFY	4		BKR5EK	7956	23	LPG 1
406 Phase 2		1.8	86	09.00 - 06.04	EW7J4-6FZ	4	0,9	LFR5B	7113		LPG 7
406 TD Phase 2		2.0	66	04.99 - 04.04	DW10TD	4	<input checked="" type="checkbox"/>	Y-504J	1441	24	
406 TD Phase 2		2.0	81	04.99 - 04.04	DW10ATED	4	<input checked="" type="checkbox"/>	Y-504J	1441	24	
406 2.2 Hdi		2.2	98	03.00 - 10.04	DW12TED4	4	<input checked="" type="checkbox"/>	Y1005J	7957	56	
406 Coupe 2.2 Hdi		2.2	98	09.00 - 12.04	DW12TED4	4	<input checked="" type="checkbox"/>	Y1005J	7957	56	
406 Phase 2		2.0	101	04.99 - 02.05	EW10J4-RFR, RFN	4	0,9	LFR5B	7113		LPG 7
406 Hdi Phase 2		2.2	100	09.00 - 05.03	DW12TED4	4	<input checked="" type="checkbox"/>	Y-504J	1441	24	
406 Phase 2		2.2	117	04.99 - 02.05	EW12J4-3FZ	4	0,9	LFR5B	7113		LPG 7
406 Phase 2		3.0	140	04.99 - 02.05	ES9J4-XFZ	6		BKR6EK	2288	20	LPG 1
406 Phase 2		3.0	154	10.00 - 02.05	ES9J4S-XFX	6	1,1	PLFR5A-11	6240		LPG 7

**407**

407 Hdi		1.6	81	04.04 - 06.06	DV6TED	4	<input checked="" type="checkbox"/>	YE04	1684	40	
407 Hdi		1.6	81	03.06 -	DV6TED4	4	<input checked="" type="checkbox"/>	YE05	91322	73	
407 Hdi		2.0	93	04.04 -	DW10TED	4	<input checked="" type="checkbox"/>	Y-504J	1441	24	
407 2.0 Hdi		2.0	100	08.05 - 05.09	DW10BTED4	4	<input checked="" type="checkbox"/>	Y1005J	7957	56	
407 16V		2.0	104	09.06 -	EW10A	4	0,9	LFR5B	7113		LPG 7
407 2.0 16V		2.0		09.06 -	EW10A	4	0,9	LFR5B	7113		LPG 7
407 2.0 HDi		2.0	120	06.09 -	DW10CTED4	4	<input checked="" type="checkbox"/>	Y8001AS	8904	58	
407 2.2		2.2	116	04.04 -	EW12J4-3FZ	4	0,9	LFR5B	7113		LPG 7
407 2.2 16V		2.2	120	08.05 -	EW12J4-3FZ	4	0,9	LFR5B	7113		LPG 7
407 2.2 Hdi		2.2	125	05.06 -	DW12BTED4	4	<input checked="" type="checkbox"/>	YE08	4966		
407 2.7 V6 Hdi		2.7	150	10.05 -	DT17TED4	6	<input checked="" type="checkbox"/>	YE12	7794		
407 V6		3.0	155	04.04 -	ES9A-XFV	6	1,1	PLFR5A-11	6240		LPG 7
407 3.0 V6 24V		3.0		04.04 -	ES9A-XFV	6	1,1	PLFR5A-11	6240		LPG 7

**408**

408 Hdi		2.0	110	10 -	DW10CTED4	4	<input checked="" type="checkbox"/>	Y8001AS	8904	58	
---------	--	-----	-----	------	-----------	---	-------------------------------------	---------	------	----	--

**508**

508 1.6 Hdi 110		1.6	82	11.10 -	DV6C	4	<input checked="" type="checkbox"/>	Y8001AS	8904	58	
508 1.6 Hdi 110		1.6	84	02.12 -	DV6C	4	<input checked="" type="checkbox"/>	Y8001AS	8904	58	
508 1.6 Vti 120		1.6	88	11.10 -	EP6C	4	0,8	PLZKBR7A-G	5843		PLZKBR7A-G
508 1.6 THP 155		1.6	115	11.10 -	EP6CDT	4	0,8	PLZKBR7A-G	5843		PLZKBR7A-G
508 2.0 Hdi 140		2.0	103	11.10 -	DW10BTED4	4	<input checked="" type="checkbox"/>	Y1005J	7957	56	
508 2.0 Hdi 165		2.0	120	11.10 -	DW10CTED4	4	<input checked="" type="checkbox"/>	Y8001AS	8904	58	
508 2.0 Hdi RXH HYbrid4		2.0	120	12.11 -	DW10CTED4	4	<input checked="" type="checkbox"/>	Y8001AS	8904	58	

**605**

605 SL		2.0	79	07.89 - 06.92	XU102C-R2A	4	0,7	BCP6ES	4930	17	LPG 3
605 SRi		2.0	89	09.89 - 12.92	XU10J2-R6A	4	0,8	BCPR6ES	2330	12	LPG 3
605 SLI		2.0	89	07.92 - 07.94	XU10J2-RFZ Cat.	4	0,8	BCPR5ES	6130	32	LPG 3
605		2.0	99	08.94 - 05.99	XU10J4R-RFV	4		BKR5EK	7956	23	LPG 1
605 SRTi Turbo		2.0	104	12.92 - 05.99	XU10J2TE-RGX	4		BKR6EK	2288	20	LPG 1
605 D		2.1	60	09.89 - 06.94	XUD11A/L	4	<input checked="" type="checkbox"/>	Y-924J	7906	1	
605 TD		2.1	80	09.89 - 06.94	XUD11ATE/L, BTE	4	<input checked="" type="checkbox"/>	Y-923U	3380	1	
605 TD		2.1	80	09.98 - 07.00	XUD11ATE/BTE	4	<input checked="" type="checkbox"/>	Y-938R	5267	1	
605 TD		2.5	96	07.94 - 05.99	DK5ATE	4	<input checked="" type="checkbox"/>	Y-923U	3380	1	
605 SR, SV		3.0	125	07.89 - 06.97	ZPJ-SFZ Cat.	6		BCPR6ET	2197		LPG 3
605 3.0		3.0	140	07.97 - 05.99	ES9J4-XFZ	6		BKR6EK	2288	20	LPG 1
605 SV 24V		3.0	147	07.89 - 06.97	ZPJ4-SKZ Cat.	6		BCPR6ET	2197		LPG 3

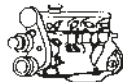
Code *l* kW

Cyl.



Stock-No.



LPG/CNG

**PEUGEOT****607**

607 Hdi		2.0	81		DW10TED	4		Y-504J	1441	24	
607 2.0 Hdi		2.0	100	09.05 -	DW10BTED4	4		Y1005J	7957	56	
607		2.0	101	05.00 - 11.04	EW10J4-RFN	4	0,9	LFR5B	7113		LPG 7
607 2.2 Hdi		2.2	98	12.99 - 02.06	DW12TED4	4		Y1005J	7957	56	
607 Hdi 16V		2.2	100	05.00 -	DW12TED4	4		Y-504J	1441	24	
607		2.2	118	05.00 -	EW12J4-3FZ	4	0,9	LFR5B	7113		LPG 7
607 Hdi		2.2	125	06.06 -	DW12BTED4	4		YE08	4966		
607 2.7 V6 Hdi		2.7	150	12.04 -	DT17	6		YE12	7794		
607 3.0 V6		3.0	152	05.00 -	ES9J4S-XFX	6	1,1	PLFR5A-11	6240		LPG 7

**806**

806		1.8	74	10.96 - 06.00	XU7JP-LFW	4		BKR5EK	7956	23	LPG 1
806 TD		1.9	68	06.94 - 08.98	XUD9TF	4		Y-923U	3380	1	
806 D		1.9	68	09.98 -	XUD9BTF	4		Y-938R	5267	1	
806 D		1.9	68	09.98 - 01.01	XUD9TF	4		Y-938R	5267	1	
806 D		2.0	80	09.98 -	DW10TED	4		Y-504J	1441	24	
806 D Hdi		2.0	81	09.99 -	DW10ATED	4		Y-504J	1441	24	
806 16V		2.0	89	06.94 - 03.95	XU10J2-RFU	4	0,8	BCPR5ES	6130	32	LPG 3
806		2.0	90	04.95 - 05.00	XU10J2-RFU	4		BKR5EK	7956	23	LPG 1
806		2.0	101	06.00 -	EW10J4-RFR	4	0,9	LFR5B	7113		LPG 7
806 Turbo		2.0	110	06.94 - 05.00	XU10J2TE-RGX	4		BKR6EK	2288	20	LPG 1
806 D		2.1	80	06.96 - 08.98	XUD11BTE	4		Y-923U	3380	1	
806 TD		2.1	80	07.96 -	XUD11ATE	4		Y-923U	3380	1	
806 D		2.1	80	09.98 - 01.01	XUD11BTE	4		Y-938R	5267	1	

**807**

807 2.0 Hdi		2.0	79	08.02 - 05.06	DW10ATED4	4		Y1005J	7957	56	
807 2.0 Hdi		2.0	80	06.02 -	DW10ATED4/RHT	4		Y-504J	1441	24	
807 2.0 Hdi		2.0	80	04.04 - 05.06	DW10ATED4	4		Y1005J	7957	56	
807 2.0 Hdi		2.0	88	11.06 -	DW10UTED4	4		Y1005J	7957	56	
807 2.0 Hdi		2.0	100	06.06 -	DW10BTED4	4		Y1005J	7957	56	
807 2.0		2.0	102	06.02 - 09.05	EW10J4-RFR	4	0,9	LFR5B	7113		LPG 7
807 2.0 16V		2.0	104	10.05 -	EW10A	4	0,9	LFR5B	7113		LPG 7
807 2.0 Hdi		2.0	120	06.09 -	DW10CTED4	4		Y8001AS	8904	58	
807 2.2 Hdi		2.2	94	06.02 -	DW12TED4/4HW	4		Y-504J	1441	24	
807 2.2 Hdi		2.2	94	08.02 - 05.06	DW12TED4	4		Y1005J	7957	56	
807 2.2 16V		2.2	118	06.02 -	EW12J4-3FZ	4	0,9	LFR5B	7113		LPG 7
807 2.2 Hdi		2.2	125	06.06 -	DW12BTED4	4		YE08	4966		
807 3.0 V6		3.0	154	06.02 -	ES9J4S-XFX	6	1,1	PLFR5A-11	6240		LPG 7

**1007**

1007 Hdi		1.4	51	01.05 -	DV4TD	4		YE05	91322	73	
1007 1.4		1.4	55	04.05 -		4	1,1	BKR6E-11	2756	14	LPG 1
1007 1.4 16V		1.4	65	10.05 -	ET3J4	4	0,8	LZKAR7A	6799		
1007 Hdi		1.4	68		DV6TD	4		YE05	91322	73	
1007 1.6 Hdi		1.6	80	06.07 -	DV6TED4	4		YE05	91322	73	
1007 1.6		1.6	81	04.05 -		4	0,9	LFR6B	6677		LPG 7

**3008**

3008 1.6 HDI		1.6	80	05.09 -	DV6TED4	4		YE05	91322	73	
3008 1.6 Hdi 110		1.6	82	08.10 -	DV6CTED4~9HZ	4		Y8001AS	8904	58	
3008 1.6 Vti 120		1.6	88	05.09 -	EP6	4	0,8	PLZKBR7A-G	5843		PLZKBR7A-G
3008 THP		1.6	110	05.09 -	EP6DT	4	0,8	PLZKBR7A-G	5843		PLZKBR7A-G
3008 1.6 THP 155		1.6	115	05.09 -	EP6CDT	4	0,8	PLZKBR7A-G	5843		PLZKBR7A-G

Code *l* kW

Cyl.



Stock-No.

E-POWER

LPG/CNG

**PEUGEOT****3008**

3008 Hdi		2.0	80	06.09 -	DW10CTED4	4		Y8001AS	8904	58	
3008 2.0 Hdi 150		2.0	110	04.09 -	DW10CTED4~ RHE, RHH	4		Y8001AS	8904	58	
3008 2.0 HDI 165		2.0	120	06.09 -	DW10CTED4	4		Y8001AS	8904	58	
3008 2.0 HDI Hybrid4		2.0	120	09.11 -	DW10CTED4	4		Y8001AS	8904	58	

**4007**

4007 2.2 Hdi		2.2	115	07.07 -	DW12MTED4	4		YE08	4966		
4007 2.4		2.4	125	02.07 -	VUSFZC/VUSFZF/ WSFZC/WSFZF	4	0,8	FR5EI	1313		FR6EI

**4008**

4008 1.6 Hdi 115		1.6	84	04.12 -	DV6	4		Y8001AS	8904	58	
4008 2.0		2.0	110	04.12 -	4B11	4	0,8	FR6EI	2687		FR6EI

**5008**

5008 1.6 Hdi 110		1.6	80	09.09 -	DV6CTED4	4		Y8001AS	8904	58	
5008 1.6 Vti 120		1.6	88	09.09 -	EP6	4	0,8	PLZKBR7A-G	5843		PLZKBR7A-G
5008 1.6 THP 155		1.6	115	09.09 -	EP6CDT	4	0,8	PLZKBR7A-G	5843		PLZKBR7A-G
5008 2.0 HDi 140		2.0	100	02.12 -	DW10CTED4	4		Y8001AS	8904	58	
5008 2.0 Hdi 150		2.0	110	09.09 -	DW10CTED4	4		Y8001AS	8904	58	
5008 2.0 Hdi 165		2.0	121	09.09 -	DW10CTED4	4		Y8001AS	8904	58	

**BIPPER**

Bipper 1.3 HDi 75		1.3	55	10.10 -	F13DTE5	4		Y9001AS	97719		
Bipper Tepee 1.3 HDi 75		1.3	55	10.10 -	F13DTE5	4		Y9001AS	97719		
Bipper 1.4 Hdi		1.4	50	02.08 -	DV4TD	4		YE05	91322	73	
Bipper 1.4		1.4	54	02.08 -	KFV (TU3A)	4	0,9	BKR6EZ	4619	38	LPG 1
Bipper Tepee 1.4		1.4	54	05.08 -	KFV (TU3A)	4	0,9	BKR6EZ	4619	38	LPG 1

**BOXER**

Boxer D		1.8	44	09.98 -	XUD7	4		Y-938R	5267	1	
Boxer D		1.9	51	03.94 - 08.98	XUD9A	4		Y-923U	3380	1	
Boxer D		1.9	51	09.98 -	XUD9AU	4		Y-938R	5267	1	
Boxer TD		1.9	68	03.94 - 08.98	XUD9TF	4		Y-923U	3380	1	
Boxer		1.9	68	09.98 -	XUD9TF	4		Y-938R	5267	1	
Boxer		2.0	81	- 03.95	XU10J2U-RFW	4	0,8	BCPR6ES	2330	12	LPG 3
Boxer		2.0	81	04.95 -	XU10J2U-RFW	4		BKR6EK	2288	20	LPG 1
Boxer 2.2 Hdi		2.2	74	12.01 - 06.06	DW12UTED	4		Y1005J	7957	56	
Boxer 2.2 Hdi 100		2.2	74	04.06 -	4HV	4		Y-548J	94832	75	
Boxer 2.2 Hdi 120		2.2	88	04.06 -	4HU	4		Y-548J	94832	75	
Boxer		2.5	63	03.94 - 08.98	DJ5	4		Y-923U	3380	1	
Boxer TD		2.5	76	03.94 - 08.96	DJ5T	4		Y-923U	3380	1	
Boxer Tdi		2.5	76	09.96 -	DJ5TED	4		Y-738U	5390		
Boxer Hdi		2.8	93	10.97 -	Sofim	4		Y-924U	4950	1	
Boxer 3.0 Hdi		3.0	107	04.10 -	F30DT	4		Y8005J	96853	64	
Boxer 3.0 Hdi 160		3.0	116	04.06 -	F30DT	4		Y8005J	96853	64	
Boxer 2 Hdi		2.0	66	09.98 -	DW10TD	4		Y-504J	1441	24	
Boxer 2 Hdi		2.2	100	03.01 -	DW10TED4	4		Y-504J	1441	24	

**EXPERT**

Expert		1.6	59	95 -	1580 SPI 222A2.000	4	0,8	BCPR7ES	3330		BCPR7EIX
Expert 1.6 Hdi		1.6	66	01.07 -	DV6UTED4	4		YE05	91322	73	
Expert		1.8	44	09.98 -	DW8	4		Y-503R	4279	10	

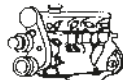
Code *l* kW

Cyl.



Stock-No.



LPG/CNG

**PEUGEOT  
EXPERT**

Expert TD		1.8	59	09.98 -	DW8TD	4		Y-503R	4279	10	
Expert		1.8	74	96 -	XU7JP	4		BKR5EK	7956	23	LPG 1
Expert		1.9	51	01.96 - 08.98	XUD9A	4		Y-924J	7906	1	
Expert		1.9	51	09.98 -	XUD9A	4		Y-924J	7906	1	
Expert TD		1.9	66	09.95 - 08.98	XUD 9TE	4		Y-924J	7906	1	
Expert		1.9	68	01.96 - 08.98	XUD9BTF	4		Y-924J	7906	1	
Expert		1.9	68	01.96 - 08.98	XUD9TF	4		Y-924J	7906	1	
Expert TD		1.9	68	09.98 -	XUD9BTF	4		Y-924J	7906	1	
Expert TD		1.9	68	09.98 -	XUD9TF	4		Y-924J	7906	1	
Expert Hdi		2.0	70	02.00 -	DW10TED	4		Y-504J	1441	24	
Expert 2.0 Hdi 100		2.0	72	03.11 -	DW10CE	4		Y8001AS	8904	58	
Expert Hdi		2.0	81	02.00 -	DW10ATED	4		Y-504J	1441	24	
Expert Hdi		2.0	88	11.06 -	DW10UTED4	4		Y1005J	7957	56	
Expert 2.0 Hdi 130		2.0	94	03.11 -	DW10CD	4		Y8001AS	8904	58	
Expert Hdi		2.0	100	11.06 -	DW10BTED4	4		Y1005J	7957	56	
Expert		2.0	101	06.00 -	EW10J4-RFN	4	0,9	LFR5B	7113		LPG 7
Expert		2.0	104	01.07 -	EW10A	4	0,9	LFR5B	7113		LPG 7
Expert 2.0 16V		2.0	105	01.07 -	EW10A	4	0,9	LFR5B	7113		LPG 7
Expert 2.0 Hdi 165		2.0	120	09.09 -	DW10CTED4	4		Y8001AS	8904	58	
Expert		2.1	80	07.96 -	XUD11ATE	4		Y-923U	3380	1	

**J5**

J5		1.9	51	11.87 - 01.94	XUD9A	4		Y-924J	7906	1	
J5 D		1.9	51	11.87 -	XUD9A	4		Y-924J	7906	1	
J5 D		2.5	54	09.81 - 06.91	CRD93	4		Y-208T	1250		
J5		2.5	54	07.91 - 03.94	CRD93	4		Y-924J	7906	1	
J5 TD		2.5	70	07.87 - 06.91	CRD93LS	4		Y-208T	1250		
J5		2.5	70	07.91 - 03.94	CRD93LS	4		Y-924J	7906	1	

**PARTNER**

Partner		1.1	44	07.96 -	TU1M+HDZ	4		BKR6EK	2288	20	LPG 1
Partner		1.4	55	07.96 -	TU3JP-KFX/KFW	4		BKR6EK	2288	20	LPG 1
Partner 1.4 Hdi		1.4	55	03.06 -	DV6	4		YE05	91322	73	
Partner 1.6 Hdi		1.6	55	04.08 -	DV6BTED4	4		YE05	91322	73	
Partner 1.6 Hdi		1.6	66	03.06 -	DV6	4		YE05	91322	73	
Partner		1.8	66	07.97 -	XU7JB-LFX	4		BKR6EK	2288	20	LPG 1
Partner Combi		1.8	43	07.96 - 08.98	XUD7	4		Y-923U	3380	1	
Partner Combi		1.8	44	09.98 - 03.02	XUD7	4		Y-938R	5267	1	
Partner Combi		1.8	44	09.98 - 03.02	DW8	4		Y-503R	4279	10	
Partner Combi		1.8	59	09.98 - 03.02	DW8TD	4		Y-503R	4279	10	
Partner Combi		1.9	51	07.96 - 08.98	XUD9A	4		Y-923U	3380	1	
Partner Combi		1.9	51	09.98 - 03.02	XUD9A	4		Y-938R	5267	1	
Partner Combi		1.9	51	09.98 - 03.02	DW8 / DW8B	4		Y-503R	4279	10	
Partner Combi Hdi		2.0	66	10.99 - 03.02	DW10TD	4		Y-504J	1441	24	
Partner Multispace		1.4	55	01.97 - 12.99	TU3JP-KFX/KFW	4		BKR6EK	2288	20	LPG 1
Partner Multispace		1.4	55	01.00 -	TU3JP-KFX/KFW	4	0,9	BKR6EZ	4619	38	LPG 1
Partner Multispace		1.6	81	02.01 -	TU5JP4-NFU	4	0,9	LFR6B	6677		LPG 7
Partner Multispace		1.8	66	07.97 -	XU7JB-LFX	4		BKR6EK	2288	20	LPG 1
Partner Multispace		1.9	51	01.97 - 09.98	XUD9A	4		Y-923U	3380	1	
Partner Multispace		1.9	51	09.98 -	DW8 / DW8B	4		Y-503R	4279	10	
Partner Multispace Hdi		2.0	66	10.99 -	DW10TD	4		Y-504J	1441	24	

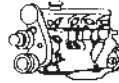
Code *l* kW

Cyl.



Stock-No.



LPG/CNG

**PEUGEOT****RCZ**

RCZ 1.6 155 THP		1.6	115	03.10 -	EP6CDT	4	0,8	PLZKBR7A-G	5843		PLZKBR7A-G
RCZ 1.6 200 THP		1.6	147	06.10 -	EP6CDTX	4	0,8	ILZKBR7A-8G	5992		ILZKBR7A-8G
RCZ 2.0 Hdi 165		2.0	120	03.10 -	DW10CTED4	4		Y8001AS	8904	58	

**PIAGGIO**

Porter 1.3i 16V		1.3	48	05.98 -	HC-ES	4		BKUR6EK	2213		
-----------------	--	-----	----	---------	-------	---	--	---------	------	--	--

**PORSCHE****911 SERIE 964**

911 Turbo	964	3.3	236	91 - 92	M30.69	6	0,8	BPR8EIX	6684		BPR9EIX
911 Turbo S	964	3.3	280	92 - 92	M30.69SL	6	0,8	BPR8EIX	6684		BPR9EIX
911 Carrera 2	964	3.6	184	90 - 93	M64.01	6		BCPR7ET	2164		BCPR7EIX
911 Carrera 2	964	3.6	184	90 - 93	M64.02	6		BCPR7ET	2164		BCPR7EIX
911 Carrera 4	964	3.6	184	90 - 93	M64.01	6		BCPR7ET	2164		BCPR7EIX
911 Carrera RS America	964	3.6	184	92 - 92	M64.01	6		BCPR7ET	2164		BCPR7EIX
911 Turbo Look	964	3.6	184	92 - 92	M64.01	6		BCPR7ET	2164		BCPR7EIX
911 Turbo Look	964	3.6	184	92 - 92	M64.02	6		BCPR7ET	2164		BCPR7EIX
911 Carrera RS	964	3.6	191	92 - 92	M64.03	6		BCPR7ET	2164		BCPR7EIX
911 Turbo 3,6	964	3.6	265	93 - 93	M64.50	6		BKR6EK	2288	20	LPG 1

**911 SERIE 993**

911 Carrera 2	993	3.6	184	94 - 95	M64.01	6		BCPR7ET	2164		BCPR7EIX
911 Carrera 2	993	3.6	184	94 - 95	M64.02	6		BCPR7ET	2164		BCPR7EIX
911 Carrera 2 Speedster	993	3.6	184	94 - 94	M64.01	6		BCPR7ET	2164		BCPR7EIX
911 Carrera 2 Speedster	993	3.6	184	94 - 94	M64.02	6		BCPR7ET	2164		BCPR7EIX
911 Carrera 4 Turbo Look	993	3.6	184	94 - 94	M64.01	6		BCPR7ET	2164		BCPR7EIX
911 Carrera	993	3.6	200	93 - 97	M64.07	6		BCPR7ET	2164		BCPR7EIX
911 Carrera	993	3.6	200	93 - 97	M64.08	6		BCPR7ET	2164		BCPR7EIX
911 Carrera	993	3.6	200	93 - 97	M64.23	6		BCPR7ET	2164		BCPR7EIX
911 Carrera	993	3.6	200	93 - 97	M64.24	6		BCPR7ET	2164		BCPR7EIX
911 Carrera	993	3.6	200	94 - 95	M64.05	6		BCPR7ET	2164		BCPR7EIX
911 Carrera	993	3.6	200	94 - 95	M64.06	6		BCPR7ET	2164		BCPR7EIX
911 Carrera 4	993	3.6	200	95 - 95	M64.05	6		BCPR7ET	2164		BCPR7EIX
911 Carrera	993	3.6	210	97 - 97	M64.21	6		BCPR7ET	2164		BCPR7EIX
911 Carrera	993	3.6	210	97 - 97	M64.22	6		BCPR7ET	2164		BCPR7EIX
911 Carrera 4	993	3.6	210	97 - 98	M64.21	6		BCPR7ET	2164		BCPR7EIX
911 Carrera 4 S	993	3.6	210	97 - 98	M64.21	6		BCPR7ET	2164		BCPR7EIX
911 Carrera S	993	3.6	210	97 - 98	M64.21	6		BCPR7ET	2164		BCPR7EIX
911 Carrera S	993	3.6	210	97 - 98	M64.22	6		BCPR7ET	2164		BCPR7EIX
911 Carrera 4s	993	3.6	221	96 - 96	M64.21	6		BCPR7ET	2164		BCPR7EIX
911 Turbo 3.6	993	3.6	265	94 - 94	M64.50	6		BKR6EK	2288	20	LPG 1
911 Turbo Biturbo	993	3.6	300	95 - 97	M64.60	6		BKR6EK	2288	20	LPG 1
911 Turbo 3.6 Biturbo	993	3.6	300	98 - 98	M64.60	6		BKR6EK	2288	20	LPG 1
911 GT2	993	3.6	316	96 - 98	M64.60R	6		BKR6EK	2288	20	LPG 1
911 Carrera	993	3.8	210	96 - 96	M64.05	6		BCPR7ET	2164		BCPR7EIX
911 Carrera	993	3.8	210	96 - 96	M64.06	6		BCPR7ET	2164		BCPR7EIX
911 Carrera 4	993	3.8	210	96 - 96	M64.05	6		BCPR7ET	2164		BCPR7EIX
911 Carrera RS America	993	3.8	221	95 - 96	M64.20	6		BCPR7ET	2164		BCPR7EIX

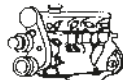

Code *ℓ* kW

Cyl.



Stock-No.



LPG/CNG

**PORSCHE  
911 SERIE 996**

911 Carrera	996	3.4	221	98 - 98	M96.01	6		BKR6EQUP	3199	30	LPG 1
911 Carrera 2	996	3.4	221	99 - 00	M96.01	6		BKR6EQUP	3199	30	LPG 1
911 Carrera 4	996	3.4	221	99 - 00	M96.02	6		BKR6EQUP	3199	30	LPG 1
911 Carrera 2	996	3.4	221	01 - 04	M96.04	6		BKR6EQUP	3199	30	LPG 1
911 Carrera 4	996	3.4	221	01 - 00	M96.04	6		BKR6EQUP	3199	30	LPG 1
911 Carrera	996	3.6	235	01 - 03	M96.03	6		BKR7EQUP	4285		
911 GT3	996	3.6	265	00 - 00	M96.76	6		BKR6EK	2288	20	
911 GT3	996	3.6	280	01 - 04	M96.76/ M 96.79	6	0,7	BKR7EIX	2667		BKR8EIX
911 Turbo	996	3.6	309	01 - 06	M96.70	6		BCPR7ET	2164		BCPR7EIX
911 GT2	996	3.6	340	01 - 04	M96.70S	6		BKR7EKC	7354		

**911 SERIE 997**

911 Carrera	997	3.6	239	04 -	M96.05	6		BKR7EQUP	4285		
911 Carrera S (997)	997	3.8	261	04 -	M97.01	6		BKR7EQUP	4285		

**968**

968		3.0	176	08.91 - 11.95	M 44.43/44	4	0,8	BPR6ES	7822	2	LPG 2
968 Turbo S		3.0	224	01.93 - 11.95		4	0,8	BKR6ES	3783	28	LPG 1

**BOXSTER SERIE 986**

Boxster 2.5	986	2.5	150	09.96 - 08.99	M 96.20	6		BKR6EK	2288	20	LPG 1
Boxster 2.7	986	2.7	162	09.99 - 07.02	M 96.22	6		BKR6EQUP	3199	30	LPG 1
Boxster 2.7	986	2.7	168	07.02 -	M 96.23	6		BKR6EQUP	3199	30	LPG 1
Boxster S 3.2	986	3.2	185	09.99 - 07.02	M 96.21	6		BKR6EQUP	3199	30	LPG 1
Boxster S 3.2	986	3.2	191	07.02 -	M 96.24	6		BKR6EQUP	3199	30	LPG 1

**BOXSTER SERIE 987**

Boxster 2.7	987	2.7	176	12.04 -	M 96.25	6		BKR7EQUP	4285		
Boxster 2.7	987	2.7	180	07.06 -	M 97.20	6		BKR7EQUP	4285		
Boxster 2.9	987	2.9	188	08 -	M 96.25 / 20	6		BKR7EQUP	4285		
Boxster S 3.2	987	3.2	206	09.04 - 08.06	M 96.26	6		BKR7EQUP	4285		
Boxster S 3.4	987	3.4	217	09.06 -	M 97.21	6		BKR7EQUP	4285		
Boxster S 3.4	987	3.4	228	08 -	M 97.26 / 21	6		BKR7EQUP	4285		
Boxster Spyder 3.4	987	3.4	236	08 -	M 97.21	6		BKR7EQUP	4285		

**CAYENNE SERIE 955**

Cayenne	955	2.5	128	04 -	BAC	5		Y-741U	6943	20	
Cayenne 3.2	955	3.2	184	10.03 -	M 02.2Y BFD	6	0,9	IZKR7B	7563		IZKR7B
Cayenne S 4.5	955	4.5	250	10.02 -	M 48.00	8		BKR6EQUP	3199	30	LPG 1
Cayenne Turbo 4.5	955	4.5	331	10.02 -	M 48.50	8		PFR7Q	7963		PFR7Q

**CAYENNE**

Cayenne 3.6		3.6	220	06.10 -	M55.02	6	0,8	ILZKR8A	94290		ILZKR8A
-------------	--	-----	-----	---------	--------	---	-----	---------	-------	--	---------

**CAYMAN SERIE 987**

Cayman 2.7	987 Cayman	2.7	180	09.06 -	M 97.20	6		BKR7EQUP	4285		
Cayman 2.9	987 Cayman	2.9	195	08 -	M 97.20	6		BKR7EQUP	4285		
Cayman S 3.4	987 Cayman	3.4	217	11.05 -	M 97.21	6		BKR7EQUP	4285		
Cayman S 3.4	987 Cayman	3.4	236	08 -	M 97.21	6		BKR7EQUP	4285		

**PROTON**

1300		1.3		- 10.92		4	0,8	BPR6ES	7822	2	LPG 2
1300		1.3		10.92 -	Multipoint	4	0,9	BPR5ES	7422	6	LPG 2

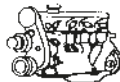
Code *l* kW

Cyl.



Stock-No.

VEMO

E-PROMER

LPG/CNG

**PROTON**

1500		1.5		- 10.92		4	0,8	BPR6ES	7822	2	LPG 2
1500		1.5		10.92 -	Multipoint	4	0,9	BPR5ES	7422	6	LPG 2
313		1.3	55	96 -	(Mitsubishi)	4	1,1	BPR5ES-11	4424		LPG 2
315		1.5	64	96 -	(Mitsubishi)	4	1,1	BKR6E-11	2756	14	LPG 1
318 GTI		1.9	100	09.99 -		4	1,1	BKR6E-11	2756	14	LPG 1
413		1.3	55	05.96 -	C96	4	1,1	BPR5ES-11	4424		LPG 2
415		1.5	66	03.95 -	C97	4	1,1	BPR5ES-11	4424		LPG 2
416		1.6	85	03.95 -	C98	4	1,1	BKR6E-11	2756	14	LPG 1
418		1.8	85	05.96 -	C99	4	1,1	BKR6E-11	2756	14	LPG 1
418 LRS		1.8	99	98 -		4	1,1	BKR6E-11	2756	14	LPG 1
Persona		1.3			4G13	4	0,8	BPR6ES	7822	2	LPG 2
Persona		1.5		11.93 -	4G15	4	0,9	BPR5ES	7422	6	LPG 2
Persona		1.6		11.93 -	4G92	4	1,1	BKR6E-11	2756	14	LPG 1
Persona		1.8		09.96 -	4G92	4	1,1	BKR6E-11	2756	14	LPG 1
Satria		1.3		03.00 -		4	0,9	BPR5ES	7422	6	LPG 2
Wira		1.5		03.00 -	4G15	4	1,1	BPR5ES-11	4424		LPG 2
Wira		1.6		05.00 -	4G92	4	1,1	BKR6E-11	2756	14	LPG 1
Wira		1.8		05.00 -		4	1,1	BKR6E-11	2756	14	LPG 1

**RELIANT**

Robin				09.96 -		4	0,8	BCPR5ES	6130	32	LPG 3
-------	--	--	--	---------	--	---	-----	---------	------	----	-------

**RENAULT****AVANTIME**

Avantime 2.0i 16V Turbo		2.0	121	04.02 - 05.03	F4RT 760/762	4	0,9	PFR6G-9	4377		PFR7G
Avantime 16V Turbo		2.0	121	04.02 - 05.03	F4R 760/761	4	0,8	BKR6EIX	6418		LPG 1
Avantime 2.2 dCi		2.2	110	06.02 - 05.03	G9T 712	4		Y-517J	3319	66	
Avantime 3.0 V6		3.0	154	02.02 - 05.03	L7X 720/721	6	1,1	PLFR5A-11	6240		LPG 7

**CLIO 1**

Clio		1.1	35	06.90 - 03.96	C1E 700	4	0,8	BP5ES	6511	8	LPG 2
Clio		1.2	40	06.90 - 02.98	E5F 710/716	4	0,8	BGP5ES	7496	16	LPG 3
Clio		1.2	40	06.90 - 02.98	E5F 710/716	4	0,8	BGP5ES	7496	16	LPG 3
Clio		1.2	40	06.90 - 02.98	E7F 706/700	4	0,8	BGP5ES	7496	16	LPG 3
Clio		1.2	40	11.94 - 03.96	C3G 720	4	0,8	BP5ESZ	4691		LPG 2
Clio		1.2	44	01.96 - 06.97	D7F 730	4	0,9	BK5ESZ	5675		
Clio		1.2	44	07.97 - 02.98	D7F 730	4		BKR5EK	7956	23	LPG 1
Clio		1.4	55	06.90 - 02.98	E6J 712 / 713	4	0,8	BGP5ES	7496	16	LPG 3
Clio		1.4	55	06.90 -	E7J 718 / 719	4	0,8	BGP5ES	7496	16	LPG 3
Clio		1.4	55	04.96 -	E7J 754	4	0,8	BGP5ES	7496	16	LPG 3
Clio		1.4	58	06.90 - 02.98	E7J 710 / 711	4	0,8	BGP5ES	7496	16	LPG 3
Clio		1.7	66	06.90 - 03.96	F2N 770	4	0,8	BP7ES	2412		BPR8EIX
Clio		1.8	65	06.90 - 04.96	F3P 710/714	4	0,9	BP6ESZ	7639		LPG 2
Clio		1.8	65	06.96 - 02.98	F3P 755	4	0,9	BP6ESZ	7639		LPG 2
Clio		1.8	66	06.90 - 02.98	F3P	4	0,7	BP6ESZ	7639		LPG 2
Clio RSi		1.8	79	08.94 -	F3P 758 Cat.	4	0,8	BP7ES	2412		BPR8EIX
Clio		1.8	79	08.95 -	F3P R758	4	0,7	BP6ES	7811	4	LPG 2
Clio		1.8	81	02.91 - 04.96	F3P 712	4	0,7	BP6ESZ	7639		LPG 2
Clio 16V		1.8	100	03.91 - 03.96	F7P 720/722	4		BKR6EKUB	3584		LPG 1
Clio		1.9	47	05.90 - 02.91		4		Y-908R	4585	1	
Clio		1.9	48	05.90 - 09.98	F8Q 714/730/732	4		Y-913M	3965	15	

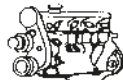
Code *l* kW

Cyl.

Stock-No.  
**VLIVE**  
10-15-17-19-20-21-22-23

LPG/CNG

**RENAULT  
CLIO 1**

Clio		1.9	48	03.91 - 08.98	F8Q 672/676/678/ 692/696	4		Y-927R	5171	19	
Clio Williams 2.0 16S		2.0	110	12.93 - 01.96	F7R 700	4		BKR6EKUB	3584		LPG 1

**CLIO 2**

Clio 2		1.2	44	03.98 -	D7F 720/722	4		BKR5EK	7956	23	LPG 1
Clio 2		1.2	44	10.99 -	D7F 726	4	0,9	BKR6EZ	4619	38	LPG 1
Clio 2		1.2	44	10.99 -	D7F 726	4	0,9	BKR6EZ	4619	38	LPG 1
Clio 2 16V		1.2	55	03.00 -	D4F 712 / 714	4	0,8	LZKAR7A	6799		
Clio 2		1.4	55	03.98 - 03.01	E7J 780	4	0,9	BKR5EZ	7642	36	LPG 1
Clio 2		1.4	55	07.00 - 03	K7J 700/701	4	0,9	BKR5EZ	7642	36	LPG 1
Clio 2		1.4	55	07.00 - 03	K7J 710	4	0,9	BKR5EZ	7642	36	LPG 1
Clio 2 16V		1.4	73	03.98 - 06.00	K4J 712/713	4	0,9	BKR6EZ	4619	38	LPG 1
Clio 2		1.6	66	03.98 - 09.99	K7M 745	4		BKR5EK	7956	23	LPG 1
Clio 2 16V		1.6	66	03.98 - 09.99	K7M 744	4		BKR5EK	7956	23	LPG 1
Clio 2		1.6	81	02.99 -	K4M 748	4	0,9	BKR6EZ	4619	38	LPG 1
Clio 2		1.9	48	03.98 - 12.03	F8Q 630/ 662 BBOEOF	4		Y-506R	4409	7	
Clio 2		1.9	48	03.99 - 12.03	F8Q 632	4		Y-516J	6416	12	
Clio 2 Dti		1.9	59	01.99 - 12.03	F9Q 716	4		Y-740U	4818	22	
Clio 2 Dti		1.9	59	03.99 - 12.03	F9Q 780	4		Y-732J	5605	4	
Clio 2 Dti		1.9	59	01.99 - 06.01	F9Q 782	4		Y-740U	4818	22	
Clio 2 16V RS		2.0	126	01.00 -	F4R 730	4	1,0	PFR6E-10	3688		

**CLIO 2 PHASE 2**

Clio 2 Phase 2		1.2	44	06.01 -	D7FGPL	4		BKR5EVX	2546		LPG 1
Clio 2 Phase 2 8S		1.2	44	06.01 -	D7F 726	4	0,9	BKR5EZ	7642	36	LPG 1
Clio 2 Phase 2 16S		1.2	55	01.02 -	D4F-712	4	0,8	LZKAR7A	6799		
Clio 2 Phase 2 16S		1.4	72	06.01 -	K4J 710/711	4	0,9	BKR6EZ	4619	38	LPG 1
Clio 2 Phase 2 1.5 Dci		1.5	48	06.01 -	K9K 700/704/710	4		Y-732J	5605	4	
Clio 2 Phase 2 1.5 Dci		1.5	50	08.04 -	K9K 714	4		Y-732J	5605	4	
Clio 2 Phase 2 1.5 Dci		1.5	59	11.01 -	K9K 702	4		Y-732J	5605	4	
Clio 2 Phase 2 1.5 Dci		1.5	60	11.03 - 04.05	K9K 702/710/716	4		Y-732J	5605	4	
Clio 2 Phase 2 1.5 Dci		1.5	74	04 -	K9K 712	4		Y-732J	5605	4	
Clio 2 Phase 2 16S		1.6	81	06.01 -	K4M 744/745	4	0,9	BKR6EZ	4619	38	LPG 1
Clio 2 Phase 2 16V RS		2.0	126	06.01 -	F4R 730	4	1,0	PFR6E-10	3688		
Clio 3 1.2 16V		1.2	55	06.05 - 05.07	D4F 740/764	4	0,8	LZKAR7A	6799		

**CLIO 3**

Clio 3 1.2 16V		1.2	55	05.07 -	D4F 722/740/772	4	0,9	LZKAR7B	5942		
Clio 3 1.2 16V Hi-Flex		1.2	55	07.08 -	D4F 740/742	4	0,9	LZKAR7B	5942		
Clio 3 TCe 100		1.2	74	05.07 -	D4F 780 / 784	4	0,7	ILKAR7A7	91432		ILKAR7A7
Clio 3 16V		1.4	70	06.05 -	K4J 780	4	0,9	BKR6EZ	4619	38	LPG 1
Clio 3 1.5 Dci		1.5	47	06.05 -	K9K 752	4		Y-732J	5605	4	
Clio 3 1.5 Dci		1.5	48	05.05 - 10.06	K9K 752	4		Y-732J	5605	4	
Clio 3 1.5 Dci		1.5	50	06.05 -	K9K 768	4		Y-732J	5605	4	
Clio 3 1.5 Dci		1.5	55	08.10 -	K9K 770	4		Y1035AS	94103	77	
Clio 3 1.5 Dci		1.5	60	11.07 -	K9K 750	4		Y-732J	5605	4	
Clio 3 1.5 Dci		1.5	63	06.05 -	K9K 766	4		Y-732J	5605	4	
Clio 3 1.5 Dci		1.5	65	08.10 -	K9K 770	4		Y1035AS	94103	77	
Clio 3 1.5 Dci		1.5	76	06.05 -	K9K 772	4		Y-732J	5605	4	
Clio 3 1.5 Dci		1.5	78	06.05 -	K9K 764	4		Y-732J	5605	4	
Clio 3 16V		1.6	81	06.05 -	K4M 800/801/804	4	0,9	BKR6EZ	4619	38	LPG 1
Clio 3 1.6 16V		1.6	94	11.07 -	K4M 862	4	0,9	PFR7Z-TG	5768		

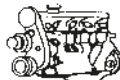
Code *l* kW

Cyl.



Stock-No.

V6/V8

E5-FORMERZ

LPG/CNG

**RENAULT****CLIO 3**

Clio 3 2.0 16V		2.0	103	04.06 -	M4R Nissan	4	1,1	PLZKAR6A-11	5118		PLZKAR6A-11
Clio 3 2.0 16V RS		2.0	145	02.06 -	F4R 830 / 832	4	0,9	PFR7Z-TG	5768		
Clio 3 2.0 16V RS		2.0	148	09.08 -	F4R 830	4	0,9	PFR7Z-TG	5768		

**CLIO 4**

Clio 4 1.2		1.2	54	10.12 -	D4F 740	4	0,7	ILKAR7A7	91432		ILKAR7A7
Clio 4 1.5 dCi 75		1.5	55	10.12 -	K9K 612	4		Y1035AS	94103	77	
Clio 4 1.5 dCi 90		1.5	66	10.12 -	K9K 608	4		Y1035AS	94103	77	

**ESPACE 2**

Espace 2		2.0		04.91 - 10.96	J7R 768 Cat	4	0,8	BP6EFS	3812	5	LPG 5
Espace 2		2.2	81	04.91 - 10.96	J7T 772 CAT	4	0,7	BP7EFS	3526		BP7EFVX
Espace 2		2.2	85	91 - 10.96	G8T 714/716/760	4		Y-740U	4818	22	
Espace 2		2.8	113	04.91 - 10.96	Z7W 712/ 717 Cat	6	0,7	BP7EFS	3526		BP7EFVX

**ESPACE 3**

Espace 3		2.0	103	09.00 -	F5R	4	1,1	LFR4AP-11	5613		
Espace 3 Dci		1.9	74	02.99 - 12.02	F9Q 722	4		Y-732J	5605	4	
Espace 3 Dti		1.9	74	02.99 - 12.02	F9Q 716/730/734	4		Y-740U	4818	22	
Grand Espace Dti		1.9	74	01.00 -	F9Q 730/734	4		Y-740U	4818	22	
Espace 3		2.0	85	11.96 - 09.00	F3R 728 /729 /768 /769	4	0,9	BPR5ES	7422	6	LPG 2
Espace 3		2.0	103	10.98 - 10.02	F4R 700 /701	4	0,9	BKR6EZ	4619	38	LPG 1
Espace 3 DT		2.2	81	10.96 - 08.00	G8T 714/716	4		Y-730U	6704	17	
Grand Espace DT		2.2	81	01.98 - 08.00	G8T 714/716	4		Y-730U	6704	17	
Espace 3 Dci		2.2	85	06.00 - 12.02	G9T 710	4		Y-517J	3319	66	
Grand Espace Dci 16S		2.2	85	06.00 - 09.02	G9T 710	4		Y-517J	3319	66	
Grand Espace 3 Dci 16S		2.2	95	06.00 - 09.02	G9T 710	4		Y-517J	3319	66	
Espace 3 Dci		2.2	96	06.00 - 12.02		4		Y-517J	3319	66	
Grand Espace Dci 16S		2.2	96	06.00 - 09.02		4		Y-517J	3319	66	
Espace 3 V6		3.0	121	11.96 - 09.98	Z7X 775	6		BKR6EKUB	3584		LPG 1
Espace 3 V6 24 V		3.0	140	10.98 -	L7X 727	6	1,0	PFR6E-10	3688		

**ESPACE 4**

Espace 4 Dci		1.9	86	10.02 -	F9Q	4		Y-732J	5605	4	
Grand Espace 4 Dci		1.9	86	10.02 -	F9Q	4		Y-732J	5605	4	
Espace 4		2.0	103	10.02 -	F4Rt	4		BKR6EK	2288	20	LPG 1
Espace 4 Turbo		2.0	121	10.02 -	F4R 760	4	0,9	PFR6G-9	4377		PFR7G
Grand Espace 4		2.0	121	03 -	F4R	4	0,9	PFR6G-9	4377		PFR7G
Grand Espace Turbo		2.0	121	03 -	F4R 760/762	4	0,9	PFR6G-9	4377		PFR7G
Espace 4 Turbo		2.0	125	03.05 -	F4R 794/795/796/ 797/896/897	4	0,9	PFR6G-9	4377		PFR7G
Grand Espace 4 Dci		2.2	110	10.02 -		4		Y-517J	3319	66	
Espace 4 Dci		2.2	110	03 -	G9T	4		Y-517J	3319	66	
Grand Espace Dci		2.2	110	03 -	G9T	4		Y-517J	3319	66	
Espace 4		3.5	180	10.02 -	V4Y 711	6	1,1	PLFR5A-11	6240		LPG 7
Grand Espace 4		3.5	180	10.02 -	V4Y 711	6	1,1	PLFR5A-11	6240		LPG 7

**EXPRESS 1**

Express		1.6	40	07.86 - 03.98	F8M 720/730/736/760	4		Y-913M	3965	15	
Express		1.9	48	09.91 - 03.98	F8Q 684/722/724/ 774/776	4		Y-913M	3965	15	
Express		1.9	48	09.94 - 12.95	F8Q 640/644/646/648	4		Y-927R	5171	19	
Express		1.9	48	01.96 - 03.98	F8Q 640/680/682	4		Y-927R	5171	19	
Express		1.0		03.86 - 08.91	C1C 706/700	4	0,8	BP5ES	6511	8	LPG 2
Express		1.1	35	06.87 - 10.97	C1E	4	0,8	BP5ES	6511	8	LPG 2

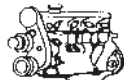
Code *l* kW

Cyl.



Stock-No.

VLINE  
10-15-20-25-30-35-40-45-50-55-60-65-70-75-80-85-90-95-100-105-110-115-120-125-130-135-140-145-150-155-160-165-170-175-180-185-190-195-200-205-210-215-220-225-230-235-240-245-250-255-260-265-270-275-280-285-290-295-300-305-310-315-320-325-330-335-340-345-350-355-360-365-370-375-380-385-390-395-400-405-410-415-420-425-430-435-440-445-450-455-460-465-470-475-480-485-490-495-500-505-510-515-520-525-530-535-540-545-550-555-560-565-570-575-580-585-590-595-600-605-610-615-620-625-630-635-640-645-650-655-660-665-670-675-680-685-690-695-700-705-710-715-720-725-730-735-740-745-750-755-760-765-770-775-780-785-790-795-800-805-810-815-820-825-830-835-840-845-850-855-860-865-870-875-880-885-890-895-900-905-910-915-920-925-930-935-940-945-950-955-960-965-970-975-980-985-990-995-1000

LPG/CNG

**RENAULT EXPRESS 1**

Express		1.4	44	03.86 - 09.91	C1J / C2J	4	0,8	BP5ES	6511	8	LPG 2
---------	--	-----	----	---------------	-----------	---	-----	-------	------	---	-------

**EXPRESS 2**

Express		1.0		10.91 -	C1C	4	0,8	BP5ES	6511	8	LPG 2
Express		1.2	40	10.91 -	C3G 710 Cat.	4	0,9	BP5ESZ	4691		LPG 2
Express		1.2		10.91 - 10.97	C1G	4	0,8	BP5ES	6511	8	LPG 2
Express		1.4	59	10.91 -	E7J Cat.	4	0,8	BGP5ES	7496	16	LPG 3
Express		1.4		10.91 -	E6J	4	0,8	BGP5ES	7496	16	LPG 3
Express		1.4		08.92 -	C3J 760 Cat.	4	0,9	BPR5ES	7422	6	LPG 2

**FLUENCE**

Fluence 1.5 dCi		1.5	63	02.10 -	K9K 830	4	<input checked="" type="checkbox"/>	Y1035AS	94103	77	
Fluence 1.5 dCi		1.5	66	02.10 -	K9K 834	4	<input checked="" type="checkbox"/>	Y1035AS	94103	77	
Fluence 1.5 dCi		1.5	78	02.10 -	K9K 832	4	<input checked="" type="checkbox"/>	Y1035AS	94103	77	
Fluence 1.5 dCi		1.5	81	02.10 -	K9K 836	4	<input checked="" type="checkbox"/>	Y1035AS	94103	77	
Fluence 1.6 16V		1.6	81	02.10 -	K4M 838/839	4	0,9	BKR6EZ	4619	38	LPG 1
Fluence 2.0 16V		2.0	103	02.10 -	M4R 714/751	4	1,1	PLZKAR6A-11	5118		PLZKAR6A-11

**KANGOO**

Kangoo (XCOA)		1.2	44	08.97 - 05.00	D7F 710/720/722/ 726/744/746	4		BKR5EK	7956	23	LPG 1
Kangoo		1.2	44	05.00 -	D7F 710/720/722/ 726 / 744 Euro2000	4	0,9	BKR6EZ	4619	38	LPG 1
Kangoo		1.2	44	05.00 -	D7F 726	4	0,9	BKR6EZ	4619	38	LPG 1
Kangoo		1.2	44	05.00 -	D7FGPL	4		BKR5EVX	2546		LPG 1
Kangoo 16V		1.2	55	07.00 -	D4F 712/714	4	0,8	LZKAR7A	6799		
Kangoo 16V		1.2	55	07 -	D4F 722/740/772	4	0,9	LZKAR7B	5942		
Kangoo (XCOC)		1.4	55	10.97 - 03.99	E7J 634/635/780	4	0,9	BKR6EZ	4619	38	LPG 1
Kangoo		1.4	55	07.00 -	K7J 700/701	4	0,9	BKR5EZ	7642	36	LPG 1
Kangoo 1.5 Dci		1.5	42	12.02 -	K9K 704	4	<input checked="" type="checkbox"/>	Y-732J	5605	4	
Kangoo 1.5 Dci		1.5	48	06.01 -	K9K 700/704	4	<input checked="" type="checkbox"/>	Y-732J	5605	4	
Kangoo 1.5 Dci		1.5	50	06.05 -	K9K 714	4	<input checked="" type="checkbox"/>	Y-732J	5605	4	
Kangoo 1.5 Dci		1.5	50	02.08 -	K9K 840	4	<input checked="" type="checkbox"/>	Y-732J	5605	4	
Kangoo 1.5 Dci		1.5	60	07.02 -	K9K 702/710	4	<input checked="" type="checkbox"/>	Y-732J	5605	4	
Kangoo 1.5 Dci		1.5	62	06.05 -	K9K 718	4	<input checked="" type="checkbox"/>	Y-732J	5605	4	
Kangoo 1.5 Dci		1.5	63	02.08 -	K9K 800/802	4	<input checked="" type="checkbox"/>	Y-732J	5605	4	
Kangoo		1.6	70	07.01 -	K7M 746	4		BKR5EK	7956	23	LPG 1
Kangoo 16V		1.6	70	07.01 -	K4M 708/750/752	4	0,9	BKR6EZ	4619	38	LPG 1
Kangoo 2 4X4		1.6	70	03 -	K4M	4	0,9	BKR6EZ	4619	38	LPG 1
Kangoo Express D		1.9	40	03.98 -	F8Q 662	4	<input checked="" type="checkbox"/>	Y-506R	4409	7	
Kangoo Express D		1.9	48	03.98 -	F8Q 630	4	<input checked="" type="checkbox"/>	Y-506R	4409	7	
Kangoo Express D		1.9	48	03.99 -	F8Q 632	4	<input checked="" type="checkbox"/>	Y-516J	6416	12	
Kangoo Dti		1.9	59	03.98 -	F9Q 780	4	<input checked="" type="checkbox"/>	Y-732J	5605	4	
Kangoo Dci 4X4		1.9	59	11.01 -		4	<input checked="" type="checkbox"/>	Y-732J	5605	4	
Kangoo Express Dci		1.5	48	07.03 -	K9K	4	<input checked="" type="checkbox"/>	Y-732J	5605	4	
Kangoo Express Dci		1.5	59	04 -	K9K	4	<input checked="" type="checkbox"/>	Y-732J	5605	4	
Kangoo Express Dci		1.9	62	04 -	F9Q	4	<input checked="" type="checkbox"/>	Y-732J	5605	4	

**KOLEOS**

Koleos 2.5		2.5	125	06.08 -	2TR700/702/703	4	1,1	DILKAR6A11	9029		DILKAR6A11
------------	--	-----	-----	---------	----------------	---	-----	------------	------	--	------------



Code *l* kW

Cyl.

Stock-No.  
**VFINE**  
BY-PROMOTER

LPG/CNG

**RENAULT****LAGUNA 1**

Laguna / Nevada		1.8	66	01.94 - 12.00	F3P 670/674/676/678	4	0,9	BP6ESZ	7639		LPG 2
Laguna / Nevada		1.8	70	01.94 - 12.00	F3P 720/724	4	0,9	BP6ESZ	7639		LPG 2
Laguna / Nevada		1.9	103	03.94 - 12.00	N7Q 700	4		BKR5EK	7956	23	LPG 1
Laguna / Nevada		2.0	83	01.94 - 03.01	F3R 722/723	4	0,9	BP6ESZ	7639		LPG 2
Laguna / Nevada D		2.2	62	09.94 -	G8T	4	█	Y-730U	6704	17	
Laguna / Nevada DT		2.2	85	03.96 -	G8T Turbo	4	█	Y-730U	6704	17	
Laguna 2		2.2	110	01.02 -	G9T 702	4	█	Y-517J	3319	66	
Laguna / Nevada		3.0	123	04.94 - 05.96	Z7X 760/765/767	6		BKR6EKUB	3584		LPG 1
Laguna / Nevada		3.0	143	06.96 - 04.98	L7X 700/701 (980511—>)	6	1,0	PFR6E-10	3688		
Laguna / Nevada		3.0		09.96 - 04.98	L7X 700/701 (—>980511)	6		BKR6EKC	2848	26	LPG 1

**LAGUNA 1 PHASE 2**

Laguna / Nevada Phase 2		1.6	81	04.98 - 12.00	K4M 720/724	4		BKR5EK	7956	23	LPG 1
Laguna / Nevada Phase 2		1.8	88	09.98 - 12.00	F4P 760	4	0,8	BKR6ES	3783	28	LPG 1
Laguna / Nevada Phase2 Dti		1.9	74	10.97 -	F9Q 716/730/734	4	█	Y-740U	4818	22	
Laguna / Nevada Phase 2		1.9	75	10.97 - 02.01	F9Q 716	4	█	Y-740U	4818	22	
Laguna / Nevada Phase 2		1.9	75	02.99 - 02.01	F9Q 710	4	█	Y-732J	5605	4	
Laguna / Nevada Phase 2		2.0	85	04.98 - 08.98	F3R	4	0,8	BPR6ES	7822	2	LPG 2
Laguna / Nevada Phase 2		2.0	103	02.99 - 12.00	F4R 780	4	0,8	BKR6ES	3783	28	LPG 1
Laguna / Nevada Phase2 DT		2.2	80	04.98 -	G8T Turbo	4	█	Y-730U	6704	17	
Laguna / Nevada Phase 2		3.0	143	05.98 - 12.00	L7X 700/701	6	1,0	PFR6E-10	3688		

**LAGUNA 2**

Laguna 2 1.6 16V		1.6	81	01.01 -	K4M 720	4	0,9	BKR6EZ	4619	38	LPG 1
Laguna 2 1.8 16V		1.8	87	01.01 -	K4M 720	4	0,8	BKR6ES	3783	28	LPG 1
Laguna 2 1.8 16V		1.8	87	01.01 -	F4P 760	4	0,8	BKR6ES	3783	28	LPG 1
Laguna 2 1.9 Dci		1.9	68	10.03 - 05.05	F9Q 664	4	█	Y-732J	5605	4	
Laguna 2 1.9 Dci		1.9	74	03.99 -	F9Q 710/717/718	4	█	Y-732J	5605	4	
Laguna 2 1.9 Dci		1.9	77	06.01 - 05.05	F9Q 752	4	█	Y-732J	5605	4	
Laguna 2 1.9 Dci		1.9	81	03.01 -		4	█	Y-732J	5605	4	
Laguna 2 1.9 Dci		1.9	81	01.05 - 08.07	F9Q 758/674	4	█	Y-732J	5605	4	
Laguna 2 1.9 Dci		1.9	88	01.01 -	F9QC 750	4	█	Y-732J	5605	4	
Laguna 2 1.9 Dci		1.9	96	03.05 - 12.07	F9Q 758/759	4	█	Y-732J	5605	4	
Laguna 2 2.0 16 V		2.0	100	04 -	F4R atmo	4	0,9	BKR6EZ	4619	38	LPG 1
Laguna 2 2.0 16V IDE		2.0	103	09.01 -	F5R 700	4	1,1	LFR4AP-11	5613		
Laguna 2 2.0 Turbo		2.0	120	01.03 - 03.05	F4R 764 / 765	4	0,9	PFR6G-9	4377		PFR7G
Laguna 2 2.0 Turbo		2.0	121	03 -	F4RT 762	4	0,9	PFR6G-9	4377		PFR7G
Laguna 2 2.0 Turbo		2.0	125	03.05 - 12.07	F4R 784	4	0,9	PFR7Z-TG	5768		
Laguna 2 2.0 Turbo		2.0	125	03.05 - 12.07	F4R 786 / 787	4	0,9	PFR6G-9	4377		PFR7G
Laguna 2 2.0 Turbo		2.0	150	03.05 - 08.07	F4R 886	4	0,9	PFR6G-9	4377		PFR7G
Laguna 2 2.0 Turbo		2.0	150	03.05 - 08.07	F4R 887	4	0,9	PFR7Z-TG	5768		
Laguna 2 2.2 dCi 115		2.2	85	04.04 - 10.05	G9T 600	4	█	Y-517J	3319	66	
Laguna 2 2.2 dCi 140		2.2	102	04.04 -	G9T 706 / 707	4	█	Y-517J	3319	66	
Laguna 2 2.2 dCi 150		2.2	110	01.02 -	G9T 710	4	█	Y-517J	3319	66	
Laguna 2 3.0 V6 24V		3.0	152	01.01 - 12.07	L7X 731	6	1,1	PLFR5A-11	6240		LPG 7
Laguna 2 3.0 V6 24V		3.0	155	01.01 - 12.07	L7X	6	1,1	PLFR5A-11	6240		LPG 7

**LAGUNA 3**

Laguna 3 1.5 Dci		1.5	80	10.07 -	K9K 780	4	█	Y-732J	5605	4	
Laguna 3 1.6 16V		1.6	85	02.07 -	K4M	4	0,9	BKR6EZ	4619	38	LPG 1
Laguna 3 2.0 16V		2.0	100	02.07 -	F4R	4	0,9	BKR6EZ	4619	38	LPG 1

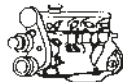
Code *l* kW

Cyl.



Stock-No.



LPG/CNG

**RENAULT  
LAGUNA 3**

Laguna 3 2.0 16V		2.0	103	02.07 -	M4R 704 / 726	4	1,1	PLZKAR6A-11	5118		PLZKAR6A-11
Laguna 3 2.0 Turbo		2.0	121	02.07 -	F4R 762	4	0,9	PFR6G-9	4377		PFR7G
Laguna 3 2.0 Turbo		2.0	125	09.07 -	F4R 811 / 813	4	0,9	PFR6G-9	4377		PFR7G
Laguna 3 2.0 GT Turbo		2.0	150	03.08 -	F4R 800	4	0,9	PFR7Z-TG	5768		

**LOGAN**

Logan (X90)		1.4	55	05 -	K7J	4	0,9	BKR6E	6962	28	LPG 1
Logan (X90)		1.6	66	05 -	K7M	4	0,9	BKR6E	6962	28	LPG 1

**MASTER**

Master T28 , T33 , T35				07.98 -		4	<input checked="" type="checkbox"/>	Y-502R	3852		
Master Dci		1.9	59	06.00 -	F9Q 770	4	<input checked="" type="checkbox"/>	Y-732J	5605	4	
Master D T30		2.1	45	11.81 - 96	852	4	<input checked="" type="checkbox"/>	Y-908R	4585	1	
Master Dci 16S		2.2	66	05.01 -	G9T 720 / 722 / 750	4	<input checked="" type="checkbox"/>	Y-517J	3319	66	
Master Dci		2.2	85	00 -	G9T 710	4	<input checked="" type="checkbox"/>	Y-517J	3319	66	
Master D T 30		2.4	52	06.82 - 96	8140 / S8U	4	<input checked="" type="checkbox"/>	Y-908R	4585	1	
Master Turbo D T35		2.5	55	06.82 - 96	S9U	4	<input checked="" type="checkbox"/>	Y-908R	4585	1	
Master D		2.5	59	07.98 -	S8U 770/772	4	<input checked="" type="checkbox"/>	Y-502R	3852		
Master D		2.5	69	09.97 -	S8V 748	4	<input checked="" type="checkbox"/>	Y-910J	3617	3	
Master 2.5 dCi 100 T28, T33, T35		2.5	73	10.03 -	G9U 754	4	<input checked="" type="checkbox"/>	Y-517J	3319	66	
Master 2.5 dCi 100 T28, T33, T35		2.5	74	08.06 -	G9U 754	4	<input checked="" type="checkbox"/>	Y-517J	3319	66	
Master 2.5 Dci 115 T28, T35, T39		2.5	84	10.01 -	G9U 720 / 750	4	<input checked="" type="checkbox"/>	Y-517J	3319	66	
Master 2.5 Dci 120 T28, T35, T39		2.5	88	08.06 -	G9U 650	4	<input checked="" type="checkbox"/>	Y-517J	3319	66	
Master 2.5 Dci 150 T28, T35, T39		2.5	107	08.06 -	G9U 632	4	<input checked="" type="checkbox"/>	Y-517J	3319	66	
Master Dti		2.8	85	09.97 -	S9W 700/702	4	<input checked="" type="checkbox"/>	Y-502R	3852		
Master Dci		3.0	96	01.07 -	ZD30CDTi	4	<input checked="" type="checkbox"/>	Y-522J	5939		

**MEGANE 1**

Megane		1.8	88	10.00 - 09.03	F4P-720 / 722	4	1,1	BKR6E-11	2756	14	LPG 1
Mégane / Classic		1.4	51	10.95 - 03.99	E7J 624	4	0,8	BCP5ES	7496	16	LPG 3
Mégane / Classic		1.4	55	10.95 - 03.99	E7J 764	4	0,8	BCP5ES	7496	16	LPG 3
Mégane / Classic		1.6	66	10.95 - 10.98	K7M 702/703/720	4	0,8	BCPR5ES	6130	32	LPG 3
Mégane Coupé / cabrio		1.6	66	10.95 - 10.98	K7M 702/703	4	0,8	BCPR5ES	6130	32	LPG 3
Mégane / Classic GPL		1.6	66	07.97 - 04.99	K7M 702	4	0,6	BKR5EIX	6341		LPG 1
Mégane / Classic		1.6	66	10.98 - 04.99	K7M 702/703/720	4	0,9	BKR5EZ	7642	36	LPG 1
Mégane Coupé / cabrio		1.6	66	10.98 - 03.99	K7M 702/703	4	0,9	BKR5EZ	7642	36	LPG 1
Mégane / Classic D		1.9	48	01.96 -	F8Q 620/624	4	<input checked="" type="checkbox"/>	Y-927R	5171	19	
Mégane / Classic D		1.9	48	03.98 -	F8Q 788	4	<input checked="" type="checkbox"/>	Y-506R	4409	7	
Mégane / Classic D		1.9	48	03.99 - 02.01	F8Q 622	4	<input checked="" type="checkbox"/>	Y-516J	6416	12	
Mégane 1.9 Dti		1.9	59	02.01 -	F9Q 744	4	<input checked="" type="checkbox"/>	Y-732J	5605	4	
Mégane / Classic Di		1.9	66	01.96 - 08.99	F9Q 730/734	4	<input checked="" type="checkbox"/>	Y-740U	4818	22	
Mégane / Classic DT		1.9	66	01.96 -	F8Q 784/786	4	<input checked="" type="checkbox"/>	Y-933J	7947	25	
Mégane / Classic Dti		1.9	74	01.96 -	F9Q 716/730/734	4	<input checked="" type="checkbox"/>	Y-740U	4818	22	
Mégane / Classic Dci		1.9	77	03.99 -	F9Q 731/732/736/740	4	<input checked="" type="checkbox"/>	Y-732J	5605	4	
Mégane / Classic		2.0	85	10.95 - 03.99	F3R 750/751/791, 796, 797, 798	4	0,9	BPR5ES	7422	6	LPG 2
Mégane Coupé / cabrio		2.0	85	10.95 - 03.99	F3R 750/751/791, 796, 797, 798	4	0,9	BPR5ES	7422	6	LPG 2
Mégane / Classic		2.0	110	10.95 - 03.99	F7R 710/714	4		BKR6EKUB	3584		LPG 1
Mégane Coupé / cabrio		2.0	110	10.95 - 03.99	F7R 710/714	4		BKR6EKUB	3584		LPG 1

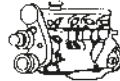
Code *l* kW

Cyl.

Stock-No.  
**VEFINE**  
BY-PROMOTER

LPG/CNG

**RENAULT  
MEGANE 1 PHASE 2**

Mégane / Classic Phase 2		1.4	55	04.99 -	E7J 626	4	0,8	BKR6ES	3783	28	LPG 1
Mégane / Classic Phase 2		1.4	70	09.99 -	K4J 750	4	0,9	BKR6EZ	4619	38	LPG 1
Mégane Coupé / cab. phase 2		1.4	70	09.99 -	K4J 750	4	0,9	BKR6EZ	4619	38	LPG 1
Mégane / Classic Phase 2		1.6	66	04.99 -	K7M 704	4		BKR5EK	7956	23	LPG 1
Mégane / Classic Phase 2		1.6	81	04.99 -	K4M 700/701/ 704, 706	4	0,9	BKR6EZ	4619	38	LPG 1
Mégane Coupé / cab. phase 2		1.6	81	04.99 -	K4M 700/701	4	0,9	BKR6EZ	4619	38	LPG 1
Mégane Coupé / cab. phase 2		1.8	87	05.01 -	F4P 760	4	0,8	BKR6ES	3783	28	LPG 1
Mégane Phase 2 D		1.9	48	09.99 -	F8Q 620/624	4	▣	Y-927R	5171	19	
Mégane Phase 2 D		1.9	48	03.99 -	F8Q 622/790	4	▣	Y-516J	6416	12	
Mégane Phase 2 Dti		1.9	59	04.01 -	F9QT 770	4	▣	Y-732J	5605	4	
Mégane Phase 2 Dti		1.9	74	01.96 -	F9Q 716/730/734	4	▣	Y-740U	4818	22	
Mégane Phase 2 Dci		1.9	77	03.99 -	F9Q 718/722/731/ 736/780	4	▣	Y-732J	5605	4	
Mégane IDE Coupé Cab. Phase 2 2.0 16V Ide		2.0	103	11.99 -	F5R 740	4	1,1	LFR4AP-11	5412		

**MEGANE 2**

Mégane 2		1.4	70	03 -	K4J 730	4	0,9	BKR6EZ	4619	38	LPG 1
Mégane 2 Coupé / cab 16 V		1.4	72	03 -	K4J	4	0,9	BKR6EZ	4619	38	LPG 1
Mégane 2 1.5 Dci		1.5	59	09.02 -	K9K 722	4	▣	Y-732J	5605	4	
Mégane 2 1.5 Dci Berline		1.5	59	09.03 -	K9K 722	4	▣	Y-732J	5605	4	
Mégane 2 1.5 Dci Break		1.5	59	09.03 -	K9K 722	4	▣	Y-732J	5605	4	
Mégane 2 1.5 Dci		1.5	63	05.05 - 02.08	K9K 724	4	▣	Y-732J	5605	4	
Mégane 2 Coupé		1.5	74	04 -	K9K	4	▣	Y-732J	5605	4	
Mégane 2 1.5 Dci		1.5	76	05.05 - 07.09	K9K 728	4	▣	Y-732J	5605	4	
Mégane 2 1.5 Dci		1.5	78	05.05 - 07.09	K9K 732/734	4	▣	Y-732J	5605	4	
Mégane 2 1.6 Flex Fuel		1.6	77	02.08 - 07.09	K4M	4	1,0	BKR6EZ	4619	38	LPG 1
Mégane 2		1.6	85	03 -	K4M 760	4	0,9	BKR6EZ	4619	38	LPG 1
Mégane 2 Coupé / cab 16V		1.6	85	03 -	K4M	4	0,9	BKR6EZ	4619	38	LPG 1
Mégane 2 1.9 Dci		1.9	81	05.05 -	F9Q 803/804/818	4	▣	Y-732J	5605	4	
Mégane 2 1.9 Dci		1.9	85	11.02 - 03.09	F9Q 804/816/818	4	▣	Y-732J	5605	4	
Mégane 2 Coupe Dci		1.9	88	09.02 -	F9Q 800	4	▣	Y-732J	5605	4	
Mégane 2 1.9 Dci		1.9	96	05.05 -	F9Q 803/816	4	▣	Y-732J	5605	4	
Mégane 2		2.0	100	03 -	F4R	4	0,9	BKR6EZ	4619	38	LPG 1
Mégane 2 Coupé / cab		2.0	100	03 -	F4R	4	0,9	BKR6EZ	4619	38	LPG 1
Mégane 2		2.0	121	05 -	F4R 762/776	4	0,9	PFR6G-9	4377		PFR7G
Mégane 2 2.0 Renault Sport		2.0	165	05.04 - 10.09	F4R 774	4	0,9	PFR7Z-TG	5768		
Mégane 2 2.0 Renault Sport		2.0	169	08.06 - 02.08	F4R 774	4	0,9	PFR7Z-TG	5768		
Megane 2 RS		2.0	147	06 -	F4R 830	4		PFR7Z-TG	5768		
Megane 2 RS		2.0	165	03.04 - 07	F4RT 774	4	0,9	PFR7G-9	4371		
Megane 2 RS		2.0	169	07 -	F4RT 774	4		PFR7Z-TG	5768		

**MEGANE 3**

Mégane 3 1.4 TCe 130		1.4	96	06.09 -	H4J 700	4	0,7	ILKAR7A7	91432		ILKAR7A7
Mégane 3 1.5 dCi		1.5	63	12.09 -	K9K 830	4	▣	Y1035AS	94103	77	
Mégane 3 1.5 dCi		1.5	66	11.08 -	K9K 834	4	▣	Y1035AS	94103	77	
Mégane 3 1.5 dCi		1.5	78	02.09 -	K9K 832	4	▣	Y1035AS	94103	77	
Mégane 3 1.5 dCi		1.5	81	02.09 -	K9K 836	4	▣	Y1035AS	94103	77	
Mégane 3 1.6 16V		1.6	74	11.08 -	K4M 812 / 848	4	0,9	BKR6EZ	4619	38	LPG 1
Mégane 3 1.6 16V		1.6	81	11.08 -	K4M 858	4	0,9	BKR6EZ	4619	38	LPG 1

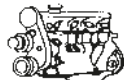
Code *l* kW

Cyl.



Stock-No.



LPG/CNG

**RENAULT  
MEGANE 3**

Mégane 3 1.9 dCi		1.9	96	06.08 -	F9Q 870 / 872	4	<input checked="" type="checkbox"/>	Y1036AS	96062		
Mégane 3 2.0 CVT		2.0	103	02.09 -	M4R 711 / 713	4	1,1	PLZKAR6A-11	5118		PLZKAR6A-11
Mégane 3 2.0 Tce 180		2.0	132	11.08 -	F4R 870 / 872	4	0,9	PFR6G-9	4377		PFR7G

**MEGANE SCENIC**

Mégane Scenic		1.9	48	10.96 - 08.99	F8Q 620/624	4	<input checked="" type="checkbox"/>	Y-927R	5171	19	
Mégane Scenic		1.9	48	03.98 -	F8Q 788	4	<input checked="" type="checkbox"/>	Y-506R	4409	7	
Mégane Scenic		1.9	48	03.99 -	F8Q 622/790	4	<input checked="" type="checkbox"/>	Y-516J	6416	12	
Mégane Scenic		1.9	66	01.96 -	F8Q 784/786	4	<input checked="" type="checkbox"/>	Y-933J	7947	25	
Mégane Scenic Di		1.9	66	10.96 - 08.99	F9Q 716/730/734	4	<input checked="" type="checkbox"/>	Y-740U	4818	22	
Mégane Scenic Dti		1.9	74	01.96 -	F9Q 716/730/734	4	<input checked="" type="checkbox"/>	Y-740U	4818	22	

**MODUS**

Modus 16 V		1.2	55	09.04 - 05.07	D4F	4	0,8	LZKAR7A	6799		
Modus		1.2	55	06.07 -	D4F 722/740/772	4	0,9	LZKAR7B	5942		
Modus TCe 100		1.2	74	05.07 -	D4F 780/784	4	0,7	ILKAR7A7	91432		ILKAR7A7
Modus 16 V		1.4	72	09.04 -	K4M	4	0,9	BKR6EZ	4619	38	LPG 1
Modus 1.5 Dci		1.5	48	09.04 -	K9K	4	<input checked="" type="checkbox"/>	Y-732J	5605	4	
Modus 1.5 Dci		1.5	50	12.04 -	K9K 768	4	<input checked="" type="checkbox"/>	Y-732J	5605	4	
Modus 1.5 Dci 75		1.5	55	10.10 -	K9K 770	4	<input checked="" type="checkbox"/>	Y1035AS	94103	77	
Modus 1.5 Dci		1.5	60	09.04 -	K9K 750	4	<input checked="" type="checkbox"/>	Y-732J	5605	4	
Modus 1.5 Dci		1.5	63	12.04 -	K9K 766	4	<input checked="" type="checkbox"/>	Y-732J	5605	4	
Modus 1.5 Dci 90		1.5	65	10.10 -	K9K 770	4	<input checked="" type="checkbox"/>	Y1035AS	94103	77	
Modus 1.5 Dci		1.5	76	05.07 -	K9K 772	4	<input checked="" type="checkbox"/>	Y-732J	5605	4	
Modus 1.5 Dci		1.5	78	05.05 -	K9K 764	4	<input checked="" type="checkbox"/>	Y-732J	5605	4	
Modus 1.6		1.6	65	12.04 -	K4M 792/794	4	0,9	BKR6EZ	4619	38	LPG 1
Modus 1.6		1.6	82	09.04 -	K4J	4	0,9	BKR6EZ	4619	38	LPG 1

**R 5**

R 5		1.0	30	10.84 - 12.96	C1C-700	4	0,7	BP6ES	7811	4	LPG 2
R 5		1.2	40	10.86 - 12.96	C1G 720/722	4	0,7	BP6ES	7811	4	LPG 2
R 5		1.4	43	10.84 - 12.96	C1J 768	4	0,7	BP6ES	7811	4	LPG 2
R 5		1.4	44	10.84 - 12.96	C3J 700/702/760	4	0,9	BPR5ES	7422	6	LPG 2
R 5		1.4	44	06.87 - 12.96	C2J 784	4	0,7	BP6ES	7811	4	LPG 2
R 5		1.4	49	10.84 - 12.96	C2J 780/781/782	4	0,7	BP6ES	7811	4	LPG 2
R 5		1.4	49	10.84 - 12.96	C2J 788/789/798	4	0,7	BP6ES	7811	4	LPG 2
R 5		1.4	50	06.87 - 12.96	C2J 700	4	0,7	BP6ES	7811	4	LPG 2
R 5 Turbo		1.4	77	10.84 - 12.96	C1J 782/784	4	0,7	B8EVX	7051		BR9EIX
R 5		1.7	55	10.86 - 12.96	F3N 716/717	4	0,8	BPR6ES	7822	2	LPG 2
R 5		1.7	66	06.87 - 12.96	F2N 740/742	4	0,7	BP6ES	7811	4	LPG 2
R 5		1.7	69	10.86 - 12.96	F3N 702	4	0,8	BP7ES	2412		BPR8EIX

**R 19**

R 19		1.2	40	09.88 - 30.92	C1G 730	4	0,9	BP5ESZ	4691		LPG 2
R 19		1.4	43	09.88 - 03.92	C1J 742, C2J 772	4	0,9	BP5ESZ	4691		LPG 2
R 19		1.4	50	09.88 - 03.96	C2J 776	4	0,8	BP5ES	6511	8	LPG 2
R 19		1.4	59	09.88 - 03.92	E6J...,E7J.... Cat.	4	0,8	BCP5ES	7496	16	LPG 3
R 19		1.7	54	03.86 -	F3N-740/741	4	0,8	BPR6ES	7822	2	LPG 2
R 19		1.7	55	09.88 - 03.96	F2N-724	4	0,8	BP7ES	2412		BPR8EIX
R 19		1.7	66	09.88 - 03.92	F3N 746	4	0,8	BPR6ES	7822	2	LPG 2
R 19		1.7	66	09.88 - 03.92	F3N-742/743 Cat	4	0,8	BP7ES	2412		BPR8EIX
R 19		1.7	68	09.88 - 03.96	F2N 720/721	4	0,8	BP7ES	2412		BPR8EIX

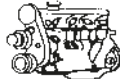
Code *l* kW

Cyl.



Stock-No.

V-TIME

LPG/CNG

**RENAULT****R 19**

R 19		1.8	54	94 -	F3N 740 / 741	4	0,8	BPR6ES	7822	2	LPG 2
R 19		1.8	81	06.89 - 03.92	F7P 700 Cat.	4		BKR6EKUB	3584		LPG 1
R 19 16V		1.8		06.89 - 03.96	F7P 704 Cat.	4	0,7	BCP6ES	4930	17	LPG 3
R 19 D		1.9	48	06.88 - 02.91	F8Q	4	█	Y-908R	4585	1	
R 19 D		1.9	48	03.91 - 12.95	F8Q 706/742/764	4	█	Y-913M	3965	15	
R 19 TD		1.9	66	09.90 - 06.96	F8Q 610/740/744/768	4	█	Y-933J	7947	25	

**R 19 PHASE 2**

R 19 Phase 2		1.2	40	04.92 - 12.95	C1G 730	4	0,8	BP5ESZ	4691		LPG 2
R 19 Phase 2		1.2	45	04.92 - 12.95	E7F 730 Cat	4	0,8	BCP5ES	7496	16	LPG 3
R 19 Phase 2		1.4	44	04.92 - 12.95	C3J 710 Cat.	4	0,9	BPR5ES	7422	6	LPG 2
R 19 Phase 2		1.4	55	04.92 - 12.95	E7J 706	4	0,8	BCP5ES	7496	16	LPG 3
R 19 Phase 2		1.4	55	04.92 - 12.95	E7J 745	4	0,8	BCP5ES	7496	16	LPG 3
R 19 Phase 2		1.4		04.92 - 12.95	C1J	4	0,8	BP5ESZ	4691		LPG 2
R 19 Phase 2		1.4		04.92 - 12.95	E6J...,E7J.... Cat.	4	0,8	BCP5ES	7496	16	LPG 3
R 19 Phase 2		1.8	70	04.92 - 12.95	F3P 704/706 Cat.	4	0,7	BP6ES	7811	4	LPG 2
R 19 Phase 2		1.8	99	04.92 - 12.95	F7P 704 Cat.	4		BKR6EKUB	3584		LPG 1
R 19 Phase 2		1.8		04.92 - 12.95	F3P 705	4	0,7	BP6ES	7811	4	LPG 2
R 19 Phase 2		1.8		04.92 - 12.95	F3P 707	4	0,7	BP6ES	7811	4	LPG 2
R 19 Phase 2		1.8		04.92 - 12.95	F7P 700 Cat.	4	0,9	BP6ESZ	7639		LPG 2

**R 21**

R 21		1.4	51	09.89 - 10.93	C2J	4	0,7	BP6ES	7811	4	LPG 2
R 21 Nevada		1.7	65	03.86 - 12.95	F2N 711	4	0,8	BP7ES	2412		BPR8EIX
R 21 Nevada		1.7	65	02.88 - 12.95	F2N 754	4	0,8	BP7ES	2412		BPR8EIX
R 21		1.7		09.89 - 12.95	F3N 726	4	0,8	BPR6ES	7822	2	LPG 2
R 21 Nevada		1.7		09.89 - 12.95	F3N 722/723	4	0,8	BP7ES	2412		BPR8EIX
R 21 D / Nevada		1.9	48	09.89 - 02.91	F8Q	4	█	Y-908R	4585	1	
R 21 D / Nevada		1.9	48	03.91 - 95	F8Q 710	4	█	Y-908R	4585	1	
R 21		2.0	66	08.86 - 12.95	F2R 702	4	0,8	BP7ES	2412		BPR8EIX
R 21		2.0	76	03.86 - 12.95	J6R	4	0,8	BP6EFS	3812	5	LPG 5
R 21 Nevada		2.0	98	05.89 - 12.95	J7R 754	4		BCP6ET	4563		LPG 3
R 21		2.0	99	06.90 - 12.93	J7R 746/747	4	0,8	BP6EFS	3812	5	LPG 5
R 21 Nevada		2.0	110	09.89 - 12.95	J7R 740	4		BCP6ET	4563		LPG 3
R 21 Nevada Turbo		2.0	119	08.89 - 10.93	J7R 752	4	0,8	BP7EFVX	3344		
R 21 Nevada Turbo		2.0	119	01.93 -	J7R 756	4	0,8	BP7EFVX	3344		
R 21 D / Nevada		2.1	53	09.89 - 12.93	J8S	4	█	Y-908R	4585	1	
R 21 TD / Nevada		2.1	65	03.86 - 12.93	J8S	4	█	Y-908R	4585	1	
R 21 Nevada		2.2	79	01.93 -	J7T 754/755	4	0,9	BP7EFS	3526		BP7EFVX

**R 25**

R 25		2.0	74	01.84 - 12.92	J6R 706/707	4	0,8	BP6EFS	3812	5	LPG 5
R 25		2.0	74	01.84 - 12.92	J6R 762/763	4	0,8	BP6EFS	3812	5	LPG 5
R 25		2.0	88	06.87 - 12.92	J7R 722/723	4	0,9	BP7EFS	3526		BP7EFVX
R 25		2.0	103	10.88 - 12.92	J7R 720/721/726	4		BCP6ET	4563		LPG 3
R 25 D		2.1	47	01.84 - 12.92	J8S 736	4	█	Y-908R	4585	1	
R 25 TD		2.1	63	01.84 - 12.92	J8S 708/738	4	█	Y-908R	4585	1	
R 25		2.2	79	10.86 - 12.92	J7T706/707/730/ 731/732/733	4	0,9	BP7EFS	3526		BP7EFVX
R 25 V6 Turbo		2.5	147	05.89 - 12.92	Z7U700 Cat.	6	0,8	BP7EFVX	3344		
R 25 V6		2.8	110	06.87 - 12.92	Z7W 700/701	6	0,9	BP7EFS	3526		BP7EFVX
R 25 V6		2.8	110	06.87 - 12.92	Z7W 706/707 Cat.	6	0,9	BP7EFS	3526		BP7EFVX

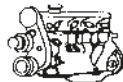

Code *l* kW

Cyl.



Stock-No.



LPG/CNG

**RENAULT  
RAPID**

Rapid 1,4		1.4		91 -		4	0,8	BCP5ES	7496	16	LPG 3
Rapid Express		1.9	34	09.94 -	F8Q 640	4		Y-927R	5171	19	

**SAFRANE**

Safrane		1.9			N7Q 716	4		BKR6EKUB	3584		LPG 1
Safrane		1.9		06.92 - 09.96	N7Q 710/ 711	4		BKR6EKUB	3584		LPG 1
Safrane		2.0	77	06.92 - 09.96	J7R 723/733	4	0,8	BP6EFS	3812	5	LPG 5
Safrane		2.0	97	04.92 - 09.96	J7R 734/735/738/739	4		BCP6ET	4563		LPG 3
Safrane DT		2.1	65	06.92 - 09.96	J8S 760	4		Y-908R	4585	1	
Safrane		2.2	103	06.92 - 09.96	J7T 760/761	4		BCP6ET	4563		LPG 3
Safrane		2.2		06.92 - 09.96	J7T 762	4	0,8	BP6EFS	3812	5	LPG 5
Safrane DT		2.5	83	03.93 - 09.96	S8U 762/763	4		Y-914U	2643	1	
Safrane V6		3.0	123	10.96 -	Z7X W755	6		BKR6EK	2288	20	LPG 1
Safrane V6		3.0	125	06.92 - 09.96	Z7X 721/722/723/ 753/755	6		BKR6EKUB	3584		LPG 1
Safrane Biturbo		3.0	194	94 - 09.96	Z7X 726	6		BKUR7ET	7873		PFR7Q

**SAFRANE PHASE 2**

Safrane Phase 2		1.9	100	10.96 - 12.00	N7Q 710/711	4		BKR5EK	7956	23	LPG 1
Safrane Phase 2 DT		2.2	85	10.96 - 11.00	G8T 740	4		Y-730U	6704	17	
Safrane Phase 2		2.5	121	10.96 - 12.00	N7U 700/701	6	0,8	BCPR6ES	2330	12	LPG 3
Safrane Phase 2 V6		3.0	125	10.96 - 03.99	Z7X 721/722/723/ 753/755	6		BKR6EKUB	3584		LPG 1
Safrane Phase 2 V6		3.0	143	04.99 - 12.00	L7X 713	6	1,0	PFR6E-10	3688		

**SCENIC 1**

Scenic		1.4	55	10.95 - 03.99	E7J 764	4	0,8	BCP5ES	7496	16	LPG 3
Scenic		1.6	66	10.95 - 09.98	K7M 702,703,720	4	0,8	BCPR5ES	6130	32	LPG 3
Scenic GPL		1.6	66	07.97 - 03.99	K7M 702	4		BKR5EK	7956	23	LPG 1
Scenic		1.6	66	10.98 - 03.99	K7M 702,703,720	4	0,9	BKR5EZ	7642	36	LPG 1
Scenic D		1.9	48	10.96 - 08.99	F8Q 620/624	4		Y-927R	5171	19	
Scenic D		1.9	48	03.98 -	F8Q 788	4		Y-506R	4409	7	
Scenic D		1.9	48	03.99 -	F8Q 622/790	4		Y-516J	6416	12	
Scenic Di		1.9	66	10.96 - 08.99	F9Q 716/730/734	4		Y-740U	4818	22	
Scenic Dti		1.9	74	01.96 -	F9Q 716/730/734	4		Y-740U	4818	22	
Scenic		2.0	85	10.95 - 03.99	F3R 750/751/791, 796,797,798	4	0,9	BPR5ES	7422	6	LPG 2
Scenic DT		1.9	66	01.96 -	F8Q 784/786	4		Y-933J	7947	25	
Scenic dci RX4		1.9	75	99 -		4		Y-732J	5605	4	

**SCENIC 1 PHASE 2**

Scenic Phase 2		1.4	70	09.99 -	K4J 750	4	0,9	BKR6EZ	4619	38	LPG 1
Scenic Phase 2		1.6	81	09.99 -	K4M 708/709	4	0,9	BKR6EZ	4619	38	LPG 1
Scenic Phase 2		1.8	87	07.00 -	F4P 760	4	0,8	BKR6ES	3783	28	LPG 1
Scenic Phase 2 D		1.9	48	09.99 -		4		Y-927R	5171	19	
Scenic Phase 2 Dti		1.9	59	06.01 -	F9Q T770	4		Y-732J	5605	4	
Scenic Phase 2 Dti		1.9	74	09.99 -	F9Q 730/734/744	4		Y-740U	4818	22	
Scenic Phase 2 Dci		1.9	77	03.99 -	F9Q 718/731/736/740	4		Y-732J	5605	4	
Scenic Phase 2 Dci RX4		1.9	77	09.00 -	F9Q 740	4		Y-732J	5605	4	
Scenic Phase 2		2.0	103	08.99 -	F4R 740/741	4	0,8	BKR6ES	3783	28	LPG 1
Scenic Phase 2		2.0	103	03.00 -	F4R 744	4	0,8	BKR6ES	3783	28	LPG 1
Scenic Phase 2		2.0	120	03.04 - 11.08	F4R 776	4	0,9	PFR6G-9	4377		PFR7G

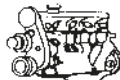
Code *l* kW

Cyl.



Stock-No.



LPG/CNG

**RENAULT****SCENIC 2**

Scenic 2 1.4		1.4	72	03 -	K4J	4	0,9	BKR6EZ	4619	38	LPG 1
Scénic 2 1.5 Dci		1.5	59	03 -	K9K	4	▣	Y-732J	5605	4	
Scénic 2 1.5 Dci		1.5	63	05.05 - 11.08	K9K 722/724	4	▣	Y-732J	5605	4	
Scénic 2 1.5 Dci		1.5	74	04.04 -	K9K 728/729	4	▣	Y-732J	5605	4	
Scenic 2 1.6		1.6	85	03 -	K4M	4	0,9	BKR6EZ	4619	38	LPG 1
Scénic 2 1.9 Dci		1.9	81	05.05 -	F9Q 803/812	4	▣	Y-732J	5605	4	
Scénic 2 1.9 Dci		1.9	88	04.04 -	F9Q 812	4	▣	Y-732J	5605	4	
Scénic 2 1.9 Dci		1.9	96	05.05 - 02.08	F9Q 803/804/816/818	4	▣	Y-732J	5605	4	
Scenic 2 2.0		2.0	100	03 -	F4R	4	0,9	BKR6EZ	4619	38	LPG 1

**SCENIC 3**

Scenic 3 TCe 130		1.4	96	02.09 -	H4J 700	4	0,7	ILKAR7A7	91432		ILKAR7A7
Scenic 3 1.5 dCi		1.5	63	04.09 -	K9K 830	4	▣	Y1035AS	94103	77	
Scenic 3 1.5 dCi		1.5	70	11.10 -	K9K 846	4	▣	Y1035AS	94103	77	
Scenic 3 1.5 dCi		1.5	78	02.09 -	K9K 832	4	▣	Y1035AS	94103	77	
Scenic 3 1.5 dCi		1.5	81	04.09 -	K9K 836	4	▣	Y1035AS	94103	77	
Scenic 3 1.9 dCi		1.9	96	12.08 -	F9Q 870	4	▣	Y1036AS	96062		
Scenic 3 2.0 16V		2.0	103	02.09 -	M4R 710 / 711	4	1,1	PLZKAR6A-11	5118		PLZKAR6A-11

**SPORT SPIDER**

Spider					F7R 710/712/720	4		BKR6EKUB	3584		LPG 1
Sport Spider		2.0	110	03.95 -	F7R 710/712/720	4		BKR6EKUB	3584		LPG 1

**THALIA / SYMBOL**

Thalia / Symbol 1.2 16V (LB0/1/2)		1.2	55	04.02 -	D4F 712	4	0,8	LZKAR7A	6799		
Thalia / Symbol 1.4 (LB0/1/2)		1.4	55	08.00 - 10.05	K7J 700	4	0,9	BKR5EZ	7642	36	LPG 1
Thalia / Symbol 1.4 16V (LB0/1/2)		1.4	72	08.00 -	K4J 712	4	0,9	BKR6EZ	4619	38	LPG 1
Thalia / Symbol 1.5 dCi (LB0/1/2)		1.5	47	06.05 -	K9K 740	4	▣	Y-732J	5605	4	
Thalia / Symbol 1.5 dCi (LB0/1/2)		1.5	48	04.02 - 10.05	K9K 700	4	▣	Y-732J	5605	4	
Thalia / Symbol 1.5 dCi (LB0/1/2)		1.5	50	02.03 -		4	▣	Y-732J	5605	4	
Thalia / Symbol 1.5 dCi (LB0/1/2)		1.5	60	06.01 -	K9K 702	4	▣	Y-732J	5605	4	
Thalia / Symbol 1.6 16V (LB0/1/2)		1.6	79	04.02 - 10.05	K4M 734/740/745	4	0,9	BKR6EZ	4619	38	LPG 1
Thalia / Symbol 1.9 D (LB0/1/2)		1.9	48	02.98 - 05.01	F8Q 630	4	▣	Y-506R	4409	7	
Thalia / Symbol II 1.2 16V		1.2	55	09.08 -	D4F 712	4	0,8	LZKAR7A	6799		
Thalia / Symbol II 1.5 dCi		1.5	47	09.08 -	K9K 740	4	▣	Y-732J	5605	4	
Thalia / Symbol II 1.5 dCi		1.5	62	09.08 -	K9K 718	4	▣	Y-732J	5605	4	
Thalia / Symbol II 1.6 16V		1.6	77	09.08 -	K4M 745	4		BKR6EZ	4619	38	LPG 1

**TRAFIC**

Trafic D T 1000		1.9	45	11.97 -	F8Q 600/606	4	▣	Y-506R	4409	7	
Trafic Dci		1.9	60	05.01 -	F9Q 762	4	▣	Y-732J	5605	4	
Trafic 1.9 Dci		1.9	74	05.01 -	F9Q 760	4	▣	Y-732J	5605	4	
Trafic T1100 / P1400 / T1400 / V1000		2.0	59	09.89 - 12.97	J5R- 829	4	0,7	BP6ES	7811	4	LPG 2
Trafic 2.0 16V		2.0	86	08.06 -	F4R 820	4	0,9	PFR6G-9	4377		PFR7G
Trafic 2.0		2.0	88	03.01 -	F4R 720 / 722	4	0,9	PFR6G-9	4377		PFR7G
Trafic D P1000, P1200, 4x4		2.1	43	11.81 - 10.97	852/720/750	4	▣	Y-908R	4585	1	
Trafic D T 1000		2.1	56	11.97 -	S8U 758/780/782	4	▣	Y-910J	3617	3	
Trafic D		2.5	52	10.82 - 10.97	S8U	4	▣	Y-208T	1250		
Trafic D		2.5	55	03.90 - 10.97	Sofim 8140	4	▣	Y-908R	4585	1	
Trafic 2.5 dCi 115		2.5	84	08.07 -	G9U 630	4	▣	Y-517J	3319	66	
Trafic 2.5 dCi 135		2.5	99	03.03 -	G9U 730	4	▣	Y-517J	3319	66	
Trafic 2.5 dCi 150		2.5	107	08.06 -	G9U 630	4	▣	Y-517J	3319	66	

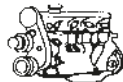
Code *l* kW

Cyl.



Stock-No.



LPG/CNG

**RENAULT  
TWINGO 1**

Twingo		1.2	40	03.93 - 06.97	C3G 700	4	0,9	BP5ESZ	4691		LPG 2
Twingo easy		1.2	40	09.94 - 96	C3G 702	4	0,9	BP5ESZ	4691		LPG 2
Twingo		1.2	44	04.94 - 06.97	D7F 730	4	0,8	BK5ESZ	5675		
Twingo		1.2	44	07.97 - 07.98	D7F 700/701/702 / 703 / 704 / 706	4		BKR5EK	7956	23	LPG 1
Twingo		1.2	44	04.00 -	D7F GPL	4		BKR5EVX	2546		LPG 1

**TWINGO 2**

Twingo 2		1.2	44	08.98 -	D7F 702/703	4		BKR5EK	7956	23	LPG 1
Twingo 2 Euro2000		1.2	44	04.00 -	D7F 726	4	0,9	BKR6EZ	4619	38	LPG 1
Twingo 2		1.2	44	06.07 -	D4F 764	4	0,9	LZKAR7B	5942		
Twingo 2		1.2	44	08 -	D7F 800	4	0,9	BKR6EZ	4619	38	LPG 1
Twingo 2 16V		1.2	55	11.00 -	D4F 702/703/704/740	4	0,8	LZKAR7A	6799		
Twingo 2		1.2	55	06.07 -	D4F 722/740/772	4	0,9	LZKAR7B	5942		
Twingo 2 Tce 100		1.2	74	06.07 -	D4F 780 / 782	4	0,7	ILKAR7A7	91432		ILKAR7A7
Twingo 2 1.5 DCI		1.5	47	06.07 -	K9K 740	4		Y-732J	5605	4	
Twingo 2 1.5 DCI 75		1.5	55	10.10 -	K9K 820	4		Y1035AS	94103	77	
Twingo 2 1.5 DCI		1.5	62	04.08 -	K9K 718	4		Y-732J	5605	4	
Twingo 2 1.5 DCI 90		1.5	63	10.10 -	K9K 820	4		Y1035AS	94103	77	
Twingo 2 1.6 RS		1.6	98	05.08 -	K4M 854/862	4	0,9	PFR7Z-TG	5768		

**VEL SATIS**

Vel Satis 16V Turbo		2.0	108	04.05 - 08.09	F4R 867	4	0,9	PFR6G-9	4377		PFR7G
Vel Satis 16V Turbo		2.0	120	03.02 - 08.09	F4R 760/762/763	4	0,9	PFR6G-9	4377		PFR7G
Vel Satis 16V Turbo		2.0	125	04.04 - 08.09	F4R 766 / 767	4	0,9	PFR6G-9	4377		PFR7G
Vel Satis		2.0	147	06 -	F4R 830	4		PFR7Z-TG	5768		
Vel Satis 2.2 Dci		2.2	85	03.02 -		4		Y-517J	3319	66	
Vel Satis 2.2 Dci		2.2	85	03.02 - 12.03	G9T	4		Y-517J	3319	66	
Vel Satis 2.2 Dci		2.2	110	03.02 - 12.03	G9T 702	4		Y-517J	3319	66	
Vel Satis 3.0 V6 24V		3.5	180	02.02 -	V4Y 701	6	1,1	PLFR5A-11	6240		LPG 7

**WIND**

Wind 1.2 TCe 100		1.2	74	07.10 -	D4F 782	4	0,7	ILKAR7A7	91432		ILKAR7A7
Wind 1.2 TCe 100		1.2	75	02.11 -	D4F 780	4	0,7	ILKAR7A7	91432		ILKAR7A7
Wind 1.6 16V 130		1.6	98	07.10 -	K4M 854	4	0,9	PFR7Z-TG	5768		

**ROLLS ROYCE**

Corniche 71—>02		6.75		01.89 - 06.93		8	0,9	BPR4EVX	3436		
Corniche 71—>02		6.75		07.93 - 08.95		8	0,9	BKR4EVX	4870		
Corniche 71—>02		6.75		09.95 -		8		BKR5EVX	2546		LPG 1
Flying Spur		6.75		08.94 - 07.95		8		BKR5EVX	2546		LPG 1
Park Ward		5.4		10.00 -	V12 BMW	12		BKR6EQUP	3199	30	LPG 1
Park Ward		6.8		02.97 - 09.00		8	0,9	BKR4EVX	4870		
Silver Dawn		6.75		94 - 98		8		BKR5EVX	2546		LPG 1
Silver Seraph		5.4	240	98 - 07.99	BMW M73B54	12		BKR6EK	2288	20	LPG 1
Silver Seraph		5.4	240	08.99 -	BMW M73B54	12		BKR6EQUP	3199	30	LPG 1
Silver Spirit/ Spur		6.75		01.89 - 06.93		8	0,9	BPR4EVX	3436		
Silver Spirit/ Spur		6.75		07.93 -		8	0,9	BKR4EVX	4870		

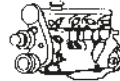
Code *l* kW

Cyl.

Stock-No.  
**VEFINE**  
BY-PROMOTER

LPG/CNG

**ROVER****25**

25 1.1		1.1	44	11.99 -	K Series	4	1,1	PFR6N-11	3546		LPG 1
25 1.1 16V		1.1	55	01.04 -	K Series	4	1,1	PFR6N-11	3546		LPG 1
25 1.4 16V		1.4	62	11.99 -	K Series	4	1,1	PFR6N-11	3546		LPG 1
25 1.6 16V		1.6	80	11.99 -	K Series	4	1,1	PFR6N-11	3546		LPG 1
25 1.8 16V		1.8	85	99 -	K Series with VVC	4	1,1	PFR6N-11	3546		LPG 1
25 Steptronic		1.8	86	05.01 -		4	1,1	PFR6N-11	3546		LPG 1
25 1.8 16V		1.8	107	02.00 -	K Series	4	1,1	PFR6N-11	3546		LPG 1
25 2.0 iDT		2.0	74	11.99 -		4	█	Y-730U	6704	17	

**45**

45 1.4		1.4	76	11.99 -	K Series	4	1,1	PFR6N-11	3546		LPG 1
45 1.6		1.6	80	11.99 -	K Series	4	1,1	PFR6N-11	3546		LPG 1
45 1.8		1.8	86	99 -	K Series	4	1,1	PFR6N-11	3546		LPG 1
45 2.0 TD		2.0	73	11.99 -		4	█	Y-730U	6704	17	
45 2.0 V6		2.0	110	99 -	KV6	6	1,1	PFR6N-11	3546		LPG 1

**75**

75 1.8		1.8	87	02.99 -	K Series	4	1,1	PFR6N-11	3546		LPG 1
75 1.8 Turbo		1.8		07.02 -	K Series	4	1,1	PFR6N-11	3546		LPG 1
75 2.0 CDT		2.0	85	99 -	M47R (BMW)	4	█	Y-507J	2691	32	
75 2.0 V6		2.0	109	02.99 -	K V6	6	1,1	PFR6N-11	3546		LPG 1
75 2.5 V6		2.5	128	02.99 -	K V6	6	1,1	PFR6N-11	3546		LPG 1

**SERIE 100**

111		1.1	44	91 -	K8 8 VALVE	4	0,9	BKR6E	6962	28	LPG 1
114		1.4	55	91 -	K8	4	0,9	BKR6E	6962	28	LPG 1
114		1.4		91 -	K16	4	0,9	BKR6E	6962	28	LPG 1
115 SD/CSD		1.5	57	01.95 - 98	TUD 5	4	█	Y-503J	1009	10	

**SERIE 200**

211		1.1	43	01.98 - 04.99	K Series 8 V	4	0,8	BKR6ES	3783	28	LPG 1
214 Mk.2		1.4		10.89 -	K Series	4	0,9	BKR6E	6962	28	LPG 1
214 Mk.3		1.4		11.95 -		4	0,9	BKR6E	6962	28	LPG 1
216 Mk.2		1.6		10.89 -	SOHC	4	1,1	BCPR6E-11	3132	11	LPG 3
216 Mk.2		1.6		09.90 -	DOHC	4	1,1	BCPR6E-11	3132	11	LPG 3
216 Mk.3		1.6		11.95 -		4	0,9	BKR6E	6962	28	LPG 1
217 SD, 218 SD/SLD		1.9	49	09.91 -	XUD 9	4	█	Y-924J	7906	1	
218 TD		1.8	65	09.91 -	XUD 7 TE	4	█	Y-924J	7906	1	
218 Mk.3		1.8	107	01.96 -	K Series with VVC	4	1,1	PFR6N-11	3546		LPG 1
218 D		1.9	49	09.91 -	XUD 9	4	█	Y-924J	7906	1	
220 SDi		2.0	63	10.95 -	20 T2R	4	█	Y-730U	6704	17	
220 SDi		2.0	77	10.95 -	20T2N (Intercooled)	4	█	Y-730U	6704	17	
220 Mk.2		2.0		06.91 -	T16 TURBO	4	0,9	BKR6E	6962	28	LPG 1

**SERIE 400**

400 D				01.87 -			█	Y-924J	7906	1	
414 Mk.1		1.4		03.90 - 07.95		4	0,9	BKR6E	6962	28	LPG 1
414 Mk.2		1.4		05.95 -		4	0,9	BKR6E	6962	28	LPG 1
Tourer 1.6		1.6	80	03.96 - 04.99	K Series	4	0,8	BKR6ES	3783	28	LPG 1
416 Mk.1		1.6		03.90 - 12.91	DOHC	4	1,1	BCPR6E-11	3132	11	LPG 3
416 Mk.1		1.6		03.90 -	SOHC	4	1,1	BCPR6E-11	3132	11	LPG 3
416 Mk.2		1.6		05.95 -	Automatik	4	1,1	BKR6E-11	2756	14	LPG 1
416 Mk.2		1.6		05.95 -	Schaltgetriebe	4	0,9	BKR6E	6962	28	LPG 1
418 SLD/GSD TD		1.8	65	09.91 - 03.96	XUD 7 T	4	█	Y-924J	7906	1	

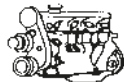
Code *ℓ* kW

Cyl.



Stock-No.



LPG/CNG

**ROVER  
SERIE 400**

418		1.8	105	03.96 - 10.97	K Series	4	1,1	PFR6N-11	3546		LPG 1
420 Mk.1		2.0		10.91 - 11.94		4	0,9	BKR6E	6962	28	LPG 1
420 Turbo		2.0		92 -	T16 TURBO	4	0,9	BKR6E	6962	28	LPG 1
420 Mk.2		2.0		12.95 -		4	0,7	BCP6ES	4930	17	LPG 3
420 SDi, SLDi TD		2.0		10.95 - 99	20 T2R, 20T2N (Intercooled)	4	█	Y-730U	6704	17	
420 D / SD		2.0	63	07.95 -		4	█	Y-730U	6704	17	
420 Di / Sdi		2.0	77	07.95 -		4	█	Y-730U	6704	17	

**SERIE 600**

618		1.8		02.96 -	Honda	4	1,1	ZFR6F-11	4291		LPG 6
620		2.0	85	04.93 -	HONDA	4	1,1	ZFR6F-11	4291		LPG 6
620 Turbo		2.0		94 -	T Series	4	0,9	BKR6E	6962	28	LPG 1
620 SDi, SLDi TD		2.0		10.95 - 99	20 T2R, 20T2N (Intercooled)	4	█	Y-730U	6704	17	
623		2.3	116	04.94 -	HONDA	4	1,1	ZFR6F-11	4291		LPG 6

**SERIE 800**

820 Turbo		2.0	132	10.92 -	20T4 TURBO MPI	4	0,9	BKR6E	6962	28	LPG 1
820		2.0		07.86 - 10.91	M16 Inj.	4	0,9	BKR6E	6962	28	LPG 1
820		2.0		03.91 - 10.91	M16 Turbo Inj.	4	0,9	BKR6E	6962	28	LPG 1
820		2.0		11.91 -	T16 / Turbo/ Inj.	4	0,9	BKR6E	6962	28	LPG 1
820 i		2.0		91 -	20T4 MPI	4	0,9	BKR6E	6962	28	LPG 1
825 SD TD		2.5	87	01.93 -	VM HR-492/ VM 425 SLIRR	4	█	Y-923U	3380	1	
825 D/SD/SLD		2.5		90 - 03.96	VM	4	█	Y-924J	7906	1	
825		2.5		03.96 - 10.99	VM	4	█	Y-741U	6943	20	
825 i		2.5		01.96 -	KV6	6	0,9	BKR6E	6962	28	LPG 1
827		2.7		02.88 - 01.96	C27A V6	6	1,1	BCPR6E-11	3132	11	LPG 3

**CITY ROVER**

City Rover 1.4		1.4		10.03 -	K Series	4	0,8	BK6E	3536		LPG 1
----------------	--	-----	--	---------	----------	---	-----	------	------	--	-------

**MAESTRO**

Maestro		1.3	51	03.89 - 12.94		4	0,8	BPR6ES	7822	2	LPG 2
Maestro		1.6	63	07.89 - 04.92	S Series	4	0,8	BCPR6ES	2330	12	LPG 3
Maestro Van TD		2.0	60	01.86 -		4	█	Y-924J	7906	1	
Maestro TD		2.0	60	07.89 -	Perkins-Prima 80 T	4	█	Y-924J	7906	1	

**METRO**

Metro		1.1		05.90 - 12.94	K8	4	0,9	BKR6E	6962	28	LPG 1
Metro D		1.4	39	01.92 - 01.95	Peugeot TUD 3	4	█	Y-910J	3617	3	
Metro /16V/16V GTI		1.4		05.90 - 01.95	K8/K16/K16	4	0,9	BKR6E	6962	28	LPG 1

**RV 8**

MG RV8		3.9	140	94 -	V8i	8	0,8	BPR6ES	7822	2	LPG 2
--------	--	-----	-----	------	-----	---	-----	--------	------	---	-------

**MINI**

Mini		1.0		10.89 - 04.92		4	0,8	BPR6ES	7822	2	LPG 2
Mini Cooper i		1.3	46	91 -	12A2EF77/SPI	4	0,8	BPR6ES	7822	2	LPG 2
Mini		1.3		10.89 -	not Turbo	4	0,8	BPR6ES	7822	2	LPG 2

**MONTEGO**

Montego 1.4		1.4		12.94 -		4	0,7	BCP6ES	4930	17	LPG 3
Montego 1.6		1.6		04.89 - 01.93		4	0,8	BCPR6ES	2330	12	LPG 3
Montego 2.0 TD		2.0	60	09.88 -	Perkins-Prima 80 T	4	█	Y-924J	7906	1	



Code *l* kW

Cyl.

Stock-No.  
**VEFINE**  
BY-PROMOTER

LPG/CNG

**ROVER****MONTEGO**

Montego 2.0		2.0	04.89 - 12.94		4	0,8	BPR6ES	7822	2	LPG 2
-------------	--	-----	---------------	--	---	-----	--------	------	---	-------

**STREETWISE**

Streetwise 1.4		1.4	07.03 -	K Series	4	1,1	PFR6N-11	3546		LPG 1
Streetwise 1.4		1.4	07.03 -	K Series	4	1,1	PFR6N-11	3546		LPG 1
Streetwise 1.6		1.6	07.03 -	K Series	4	1,1	PFR6N-11	3546		LPG 1
Streetwise 1.8		1.8	07.03 -	K Series	4	1,1	PFR6N-11	3546		LPG 1
Streetwise 2.0 TD		2.0	07.03 -		4		Y-730U	6704	17	

**SAAB****900**

900		2.0	74	- 93	B201C	4	0,7	BP6ES	7811	4	LPG 2
900		2.0	96	08.94 - 02.98	B204i	4	0,7	BCP5EVX	5664		LPG 3
900		2.0	136	10.93 -	B204L	4	1,1	BCPR7ES-11	1095		BCPR7EIX
900		2.0		- 93	B202	4	0,7	BCP5EVX	5664		LPG 3
900		2.0		- 93	B212	4	0,7	BCP5EVX	5664		LPG 3
900 S/Cabrio.		2.0		- 93	B202S	4	0,6	BCP7EVX	7681		BCPR7EIX
900 Turbo 16V		2.0		- 93	B202	4	0,8	BCP7EVX	7681		BCPR7EIX
900 Turbo 16V/S/SE/Cabrio.		2.0			B202L	4	0,6	BCP7EVX	7681		BCPR7EIX
900 Turbo		2.0		83 - 93	B201 mit / with APC	4	0,8	BP7EVX	7270		BPR8EIX
900		2.3	110	10.93 -	B234I	4	0,7	BCP6EVX	6323		LPG 3
900		2.5	125	94 -	B258 Motronic	6		BKR5EK	7956	23	LPG 1
900		2.5		10.93 -	B258i, B308i	6		BKR6EK	2288	20	LPG 1

**9000**

9000		2.0	87	09.84 - 12.98	B202L	4	1,1	BCPR7ES-11	1095		BCPR7EIX
9000		2.0	96	94 - 98	B204i	4	1,1	BCPR6ES-11	7121	11	LPG 3
9000		2.0	110	94 - 98	B204 E	4	1,1	BCPR7ES-11	1095		BCPR7EIX
9000		2.0		- 93	B202i ohne Di	4	0,7	BCP5EVX	5664		LPG 3
9000		2.0		94 - 96	B202 mit Di	4	0,8	BCPR7ES	3330		BCPR7EIX
9000		2.0		94 - 96	B202S mit Di	4	0,8	BCPR7ES	3330		BCPR7EIX
9000		2.3	96	94 - 96	B234I	4	0,7	BCP6EVX	6323		LPG 3
9000 CS 2.3-16		2.3	107	09.91 - 12.98	B234I Cat.	4	1,1	BCPR6ES-11	7121	11	LPG 3
9000		2.3	125	94 - 98	B234 E	4	1,1	BCPR7ES-11	1095		BCPR7EIX
9000		2.3	147	92 - 98	B234L	4	1,1	BCPR7ES-11	1095		BCPR7EIX
9000 Aero		2.3	165	93 - 98	B234R	4	1,1	BCPR7ES-11	1095		
9000 V6		3.0	155	11.94 - 12.98	B308 V6	6		BKR5EK	7956	23	LPG 1

**9-3 1**

9-3 2.0i	YS3D	2.0	96	02.98 - 08.03	B204i	4	0,7	BCP5EVX	5664		LPG 3
9-3 2.0 Turbo	YS3D	2.0	110	03.99 - 08.03	B205E	4	0,7	BCP5EVX	5664		LPG 3
9-3 2.0 Turbo	YS3D	2.0	113	10.98 - 08.03	B204E	4	1,1	BCPR7ES-11	1095		BCPR7EIX
9-3 2.0 Turbo	YS3D	2.0	136	02.98 - 07.03	B204L	4	1,1	BCPR7ES-11	1095		BCPR7EIX
9-3 2.0 Turbo	YS3D	2.0	136	02.98 - 07.03	B205L	4	1,0	PFR6H-10	6290		PFR7H-10
9-3 2.0 SE Turbo	YS3D	2.0	147	02.98 - 08.03	B204R	4	1,1	BCPR7ES-11	1095		BCPR7EIX
9-3 2.0 Turbo	YS3D	2.0	151	09.99 - 08.03	B205R	4	1,0	PFR6H-10	6290		PFR7H-10
9-3 2.2 TiD	YS3D	2.2	85	02.98 - 11.00	D223L / X22DTH Opel	4		Y-748U	6649	14	
9-3 2.2 TiD	YS3D	2.2	92	11.00 - 09.02	D223L	4		Y-523J	6298	37	
9-3 2.3i	YS3D	2.3	110	02.98 - 08.03	B234I	4	1,0	PFR6H-10	6290		PFR7H-10
9-3 2.3 Turbo	YS3D	2.3	165	10.98 - 03.03	B235R	4	1,0	PFR6H-10	6290		PFR7H-10
9-3 2.3	YS3D	2.3	169	09.99 - 12.02	B235R	4	1,0	PFR6H-10	6290		PFR7H-10

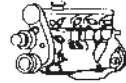
Code *l* kW

Cyl.

Stock-No.  
**VALUE**  
10-15-10-15-10-15-10-15

LPG/CNG

**SAAB****9-3 2**

9-3 1.8i	YS3F	1.8	90	11.03 - 03.09	Z18XE	4		BKR5EQUA	3566		
9-3 1.8t	YS3F	2.0	110	09.02 - 12.07	B207E	4	1,0	PFR6T-10G	5542		PFR6T-10G
9-3 1.8t	YS3F	2.0	110	01.08 - 07.12	B207E	4	1,0	PFR6D10G	1632		PFR6D10G
9-3 1.8t BioPower	YS3F	2.0	110	01.07 - 12.07	B207E	4	1,1	BKR7ESC-11	6313		
9-3 1.8t BioPower	YS3F	2.0	110	01.08 - 07.12	B207E	4	1,0	PFR6D10G	1632		PFR6D10G
9-3 1.8t BioPower from engine-no. 11765306	YS3F	2.0	129	01.10 - 07.12	B207L	4	1,0	PFR6D10G	1632		PFR6D10G
9-3 1.8t BioPower to engine-no. 11765305	YS3F	2.0	129	01.07 - 12.09	B207L	4	1,1	BKR7ESC-11	6313		
9-3 1.9 TiD	YS3F	1.9	88	03.05 - 07.12	Z19DT Fiat	4	█	Y-534J	3413	36	
9-3 1.9 TTiD	YS3F	1.9	96	12.07 - 07.12	A19DTR	4	v	Y9003AS	94251	78	
9-3 1.9 TiD	YS3F	1.9	110	03.05 - 07.12	Z19DTH	4	█	YE07	6092		
9-3 1.9 TTiD	YS3F	1.9	118	12.07 - 07.12	A19DTR	4	█	Y9003AS	94251	78	
9-3 2.0t	YS3F	2.0	110	03.05 - 12.07	B207E	4	1,0	PFR6T-10G	5542		PFR6T-10G
9-3 2.0t	YS3F	2.0	110	01.08 - 07.12	B207E	4	1,0	PFR6D10G	1632		PFR6D10G
9-3 2.0t	YS3F	2.0	120	01.07 - 12.07	B207R	4	1,0	PFR6T-10G	5542		PFR6T-10G
9-3 2.0t	YS3F	2.0	120	01.08 - 07.12	B207R	4	1,0	PFR6D10G	1632		PFR6D10G
9-3 2.0t BioPower	YS3F	2.0	120	01.07 - 12.07	B207R	4	1,1	BKR7ESC-11	6313		
9-3 2.0t BioPower	YS3F	2.0	120	01.08 - 07.12	B207R	4	1,0	PFR6D10G	1632		
9-3 2.0t	YS3F	2.0	129	09.02 - 12.07	B207L	4	1,0	PFR6T-10G	5542		PFR6T-10G
9-3 2.0t	YS3F	2.0	129	01.08 - 07.12	B207L	4	1,0	PFR6D10G	1632		PFR6D10G
9-3 2.0t BioPower	YS3F	2.0	129	01.07 - 12.07	B207L	4	1,1	BKR7ESC-11	6313		
9-3 2.0t BioPower	YS3F	2.0	129	01.08 - 07.12	B207L	4	1,0	PFR6D10G	1632		
9-3 2.0t BioPower to engine-no. 11765305	YS3F	2.0	145	06.07 - 12.07	B207R	4	1,1	BKR7ESC-11	6313		
9-3 2.0t BioPower from engine-no. 11765306	YS3F	2.0	145	01.08 - 07.12	B207R	4	1,0	PFR6D10G	1632		
9-3 2.0t	YS3F	2.0	147	06.07 - 12.07	B207R	4	1,0	PFR6T-10G	5542		PFR6T-10G
9-3 2.0t	YS3F	2.0	147	01.08 - 07.12	B207R	4	1,0	PFR6D10G	1632		PFR6D10G
9-3 2.0t BioPower to engine-no. 11765305	YS3F	2.0	147	06.07 - 12.07	B207R	4	1,1	BKR7ESC-11	6313		
9-3 2.0t BioPower from engine-no. 11765306	YS3F	2.0	147	01.08 - 07.12	B207R	4	1,0	PFR6D10G	1632		
9-3 2.0 T	YS3F	2.0	154	09.02 - 12.07	B207R	4	1,0	PFR6T-10G	5542		PFR6T-10G
9-3 2.0 T	YS3F	2.0	154	01.08 - 07.12	B207R	4	1,0	PFR6D10G	1632		PFR6D10G
9-3 2.0 T BioPower	YS3F	2.0	154	09.02 - 12.07	B207R	4	1,1	BKR7ESC-11	6313		
9-3 2.0 T BioPower	YS3F	2.0	154	01.08 - 07.12	B207R	4	1,0	PFR6D10G	1632		
9-3 2.0 T	YS3F	2.0	162	01.11 - 07.12	B207R / A20NFT	4	1,0	PFR6D10G	1632		PFR6D10G
9-3 2.0 T BioPower	YS3F	2.0	162	01.11 - 07.12	B207R / A20NFT	4	1,0	PFR6D10G	1632		
9-3 2.0 T Aero	YS3F	2.0	177	05.09 - 07.12	B207R	4	1,0	PFR6D10G	1632		PFR6D10G
9-3 2.2 TiD	YS3F	2.2	92	09.02 - 07.12	D223L	4	█	Y-523J	6298	37	
9-3 2.8 Turbo Aero	YS3F	2.8	169	04.05 - 07.12	B284E HFV6	6	1,0	PLFR6C-10G	1959		PLFR6C-10G
9-3 2.8 Turbo V6	YS3F	2.8	184	03.05 - 12.07	B284E / B284L	6	1,0	PLFR6C-10G	1959		PLFR6C-10G
9-3 2.8 Turbo V6	YS3F	2.8	184	01.08 - 07.12	B284E / B284L	6	1,0	DILFR7B10G	97218		DILFR7B10G
9-3 2.8 Turbo V6	YS3F	2.8	188	09.07 - 12.07	B284L	6	1,0	PLFR6C-10G	1959		PLFR6C-10G
9-3 2.8 Turbo V6	YS3F	2.8	188	01.08 - 07.12	B284L	6	1,0	DILFR7B10G	97218		DILFR7B10G
9-3 2.8 Turbo V6	YS3F	2.8	203	02.09 - 07.12	B284R	6	1,0	DILFR7B10G	97218		DILFR7B10G
9-3 2.8 Turbo V6	YS3F	2.8	206	09.07 - 12.07	B284R	6	1,0	PLFR6C-10G	1959		PLFR6C-10G
9-3 2.8 Turbo V6	YS3F	2.8	206	01.08 - 07.12	B284R	6	1,0	DILFR7B10G	97218		DILFR7B10G

Code *l* kW

Cyl.



Stock-No.



LPG/CNG

**SAAB****9-3 X**

9-3X 1.9 TiID	YS3F	1.9	132	02.09 - 07.12	Z19DTR	4		Y9003AS	94251	78	
9-3X 2.0 T XWD	YS3F	2.0	154	02.09 - 07.12	B207R	4	1,0	PFR6T-10G	5542		PFR6T-10G
9-3X 2.0 T BioPower XWD	YS3F	2.0	154	02.09 - 07.12	B207R	4	1,1	BKR7ESC-11	6313		
9-3X 2.0 T BioPower XWD	YS3F	2.0	162	01.11 - 07.12	B207R	4	1,0	PFR6D10G	1632		PFR6D10G

**9-5 1**

9-5 1.9 TiD	YS3E	1.9	110	01.06 - 05.10	Z19DTH	4		YE07	6092		
9-5 2.0t	YS3E	2.0	110	09.97 - 05.10	B205E	4	1,1	BCPR7ES-11	1095		BCPR7EIX
9-5 2.0t Bio Power	YS3E	2.0	132	07.07 - 05.10	A20NHL	4	1,1	BKR7ESC-11	6313		
9-5 2.0t SE	YS3E	2.0	136	07.00 - 07.01	B205L	4	1,0	PFR6H-10	6290		PFR7H-10
9-5 2.0t	YS3E	2.0	140	09.97 - 07.00	B205E Trim Kit	4	1,0	PFR6H-10	6290		PFR7H-10
9-5 2.2 TiD	YS3E	2.2	88	01.02 - 08.05	D223L	4		Y-748U	6649	14	
9-5 2.3t	YS3E	2.3	125	09.97 - 07.01	B235E	4	1,1	BCPR6ES-11	7121	11	LPG 3
9-5 2.3t	YS3E	2.3	136	09.99 - 05.10	B235E	4	1,1	BCPR6ES-11	7121	11	LPG 3
9-5 2.3t Bio Power	YS3E	2.3	155	09.06 - 05.10		4	1,1	BCPR7ES-11	1095		BCPR7EIX
9-5 2.3 Turbo	YS3E	2.3	162	07.03 - 05.10	B235L	4	1,0	PFR6H-10	6290		PFR7H-10
9-5 2.3 Turbo	YS3E	2.3	165	07.98 - 05.10	B235R	4	1,0	PFR6H-10	6290		PFR7H-10
9-5 2.3 Turbo	YS3E	2.3	169	10.99 - 09.01	B235R	4	1,0	PFR6H-10	6290		PFR7H-10
9-5 2.3 Turbo	YS3E	2.3	184	10.99 - 05.10	B235R	4	1,0	PFR6H-10	6290		PFR7H-10
9-5 2.3 Turbo	YS3E	2.3	191	11.05 - 05.10	B235R	4	1,0	PFR6H-10	6290		PFR7H-10
9-5 3.0 V6	YS3E	3.0	147	09.97 - 08.05	B308E	6	1,1	BKR7ES-11	2387		BKR8EIX

**9-5 2**

9-5 1.6T	YS3G	1.6	132	05.10 - 07.12	A16LET	4	0,9	ZFR6BP-G	1748		ZFR6BP-G
9-5 2.0T Bio Power	YS3G	2.0	162	05.10 - 07.12	A20NFT	4	0,9	ILTR5D	5476		
9-5 2.0T	YS3G	2.0	162	05.10 - 07.12	A20NHT	4	0,9	ILTR5D	5476		
9-5 2.8 T V6 XWD	YS3G	2.8	221	05.10 - 07.12	A28NER	6	1,0	DILFR7B10G	97218		DILFR7B10G

**SEAT****ALHAMBRA 1**

Alhambra 1.8 T	7V8 / 7V9	1.8	110	05.98 - 02.00	AJH	4		BKR6ETA-10	7998		
Alhambra 1.9 TDI	7V8 / 7V9	1.9	66	04.95 - 07.96	1Z	4		Y-732J	5605	4	
Alhambra 1.9 TDI	7V8 / 7V9	1.9	66	07.96 - 02.00	AHU	4		Y-732J	5605	4	
Alhambra 1.9 TDI	7V8 / 7V9	1.9	81	09.97 - 02.00	AFN	4		Y-732J	5605	4	
Alhambra 2.0	7V8 / 7V9	2.0	85	03.96 - 02.00	ADY	4		BKUR6ET	6437	27	LPG 1
Alhambra 2.8 V6	7V8 / 7V9	2.8	128	06.96 -	AAA	6		BKR5EKUP	2890		
Alhambra 1.8 T	7V8 / 7V9	1.8	110	06.00 -	AWC	4	0,8	PFR6Q	6458	37	LPG 1
Alhambra 1.9 TDI	7V8 / 7V9	1.9	66	06.00 -	ANU	4		Y-732J	5605	4	
Alhambra 1.9 TDI	7V8 / 7V9	1.9	85	06.00 -	AUY	4		Y-732J	5605	4	
Alhambra 2.0 TDI	7V8 / 7V9	1.9	96	06.05 - 05.06	ASZ	4		Y-741U	6943	20	
Alhambra 2.0	7V8 / 7V9	2.0	85	06.00 -	ATM	4		BKUR6ET-10	2397	24	LPG 1
Alhambra 2.0 TDI	7V8 / 7V9	2.0	103	11.05 -	BRT	4		CZ104	9826	52	
Alhambra 2.8 V6	7V8 / 7V9	2.8	150	06.00 - 04.02	AUE	6	1,1	PZFR5D-11	7968	34	LPG 6
Alhambra 2.8 V6	7V8 / 7V9	2.8	150	06.00 -	AYL	6	1,1	PZFR5D-11	7968	34	LPG 6

**ALHAMBRA 2**

Alhambra 1.4 TSI	710	1.4	110	06.10 -	CAVA	4	0,8	PZFR6R8EG	96498		PZFR6R8EG
Alhambra 1.4 TSI	710	1.4	110	06.10 -	CNWB	4	0,8	PZFR6R8EG	96498		PZFR6R8EG
Alhambra 1.4 TSI	710	1.4	110	06.10 -	CTHA	4	0,8	PZFR6R8EG	96498		PZFR6R8EG
Alhambra 2.0 TDI	710	2.0	85	06.11 -	CFFE	4		Y1002AS	8888	57	
Alhambra 2.0 TDI	710	2.0	100	06.10 -	CFFA	4		Y1002AS	8888	57	

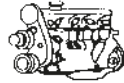
Code *l* kW

Cyl.

Stock-No.  
**VELINE**  
10-14-17-19-20-21-22-23-24-25-26-27-28-29-30-31-32-33-34-35-36-37-38-39-40-41-42-43-44-45-46-47-48-49-50-51-52-53-54-55-56-57-58-59-60-61-62-63-64-65-66-67-68-69-70-71-72-73-74-75-76-77-78-79-80-81-82-83-84-85-86-87-88-89-90-91-92-93-94-95-96-97-98-99-100-101-102-103-104-105-106-107-108-109-110-111-112-113-114-115-116-117-118-119-120-121-122-123-124-125-126-127-128-129-130-131-132-133-134-135-136-137-138-139-140-141-142-143-144-145-146-147-148-149-150-151-152-153-154-155-156-157-158-159-160-161-162-163-164-165-166-167-168-169-170-171-172-173-174-175-176-177-178-179-180-181-182-183-184-185-186-187-188-189-190-191-192-193-194-195-196-197-198-199-200-201-202-203-204-205-206-207-208-209-210-211-212-213-214-215-216-217-218-219-220-221-222-223-224-225-226-227-228-229-230-231-232-233-234-235-236-237-238-239-240-241-242-243-244-245-246-247-248-249-250-251-252-253-254-255-256-257-258-259-260-261-262-263-264-265-266-267-268-269-270-271-272-273-274-275-276-277-278-279-280-281-282-283-284-285-286-287-288-289-290-291-292-293-294-295-296-297-298-299-300-301-302-303-304-305-306-307-308-309-310-311-312-313-314-315-316-317-318-319-320-321-322-323-324-325-326-327-328-329-330-331-332-333-334-335-336-337-338-339-340-341-342-343-344-345-346-347-348-349-350-351-352-353-354-355-356-357-358-359-360-361-362-363-364-365-366-367-368-369-370-371-372-373-374-375-376-377-378-379-380-381-382-383-384-385-386-387-388-389-390-391-392-393-394-395-396-397-398-399-400-401-402-403-404-405-406-407-408-409-410-411-412-413-414-415-416-417-418-419-420-421-422-423-424-425-426-427-428-429-430-431-432-433-434-435-436-437-438-439-440-441-442-443-444-445-446-447-448-449-450-451-452-453-454-455-456-457-458-459-460-461-462-463-464-465-466-467-468-469-470-471-472-473-474-475-476-477-478-479-480-481-482-483-484-485-486-487-488-489-490-491-492-493-494-495-496-497-498-499-500-501-502-503-504-505-506-507-508-509-510-511-512-513-514-515-516-517-518-519-520-521-522-523-524-525-526-527-528-529-530-531-532-533-534-535-536-537-538-539-540-541-542-543-544-545-546-547-548-549-550-551-552-553-554-555-556-557-558-559-560-561-562-563-564-565-566-567-568-569-570-571-572-573-574-575-576-577-578-579-580-581-582-583-584-585-586-587-588-589-590-591-592-593-594-595-596-597-598-599-600-601-602-603-604-605-606-607-608-609-610-611-612-613-614-615-616-617-618-619-620-621-622-623-624-625-626-627-628-629-630-631-632-633-634-635-636-637-638-639-640-641-642-643-644-645-646-647-648-649-650-651-652-653-654-655-656-657-658-659-660-661-662-663-664-665-666-667-668-669-670-671-672-673-674-675-676-677-678-679-680-681-682-683-684-685-686-687-688-689-690-691-692-693-694-695-696-697-698-699-700-701-702-703-704-705-706-707-708-709-710-711-712-713-714-715-716-717-718-719-720-721-722-723-724-725-726-727-728-729-730-731-732-733-734-735-736-737-738-739-740-741-742-743-744-745-746-747-748-749-750-751-752-753-754-755-756-757-758-759-760-761-762-763-764-765-766-767-768-769-770-771-772-773-774-775-776-777-778-779-780-781-782-783-784-785-786-787-788-789-790-791-792-793-794-795-796-797-798-799-800-801-802-803-804-805-806-807-808-809-810-811-812-813-814-815-816-817-818-819-820-821-822-823-824-825-826-827-828-829-830-831-832-833-834-835-836-837-838-839-840-841-842-843-844-845-846-847-848-849-850-851-852-853-854-855-856-857-858-859-860-861-862-863-864-865-866-867-868-869-870-871-872-873-874-875-876-877-878-879-880-881-882-883-884-885-886-887-888-889-890-891-892-893-894-895-896-897-898-899-900-901-902-903-904-905-906-907-908-909-910-911-912-913-914-915-916-917-918-919-920-921-922-923-924-925-926-927-928-929-930-931-932-933-934-935-936-937-938-939-940-941-942-943-944-945-946-947-948-949-950-951-952-953-954-955-956-957-958-959-960-961-962-963-964-965-966-967-968-969-970-971-972-973-974-975-976-977-978-979-980-981-982-983-984-985-986-987-988-989-990-991-992-993-994-995-996-997-998-999-1000

LPG/CNG

**SEAT  
ALHAMBRA 2**

Alhambra 2.0 TDI	710	2.0	103	06.10 -	CFFB	4		Y1002AS	8888	57	
Alhambra 2.0 TDI	710	2.0	125	06.10 -	CFGB	4		Y1002AS	8888	57	
Alhambra 2.0 TSI	710	2.0	147	11.10 -	CCZA	4	0,8	PFR7S8EG	1675		PFR8S8EG

**ALTEA**

Altea 1.2 TSI	5P1	1.2	77	04.10 -	CBZB	4	0,7	IZFR6P7	97153		IZFR6P7
Altea 1.4	5P1	1.4	63	05.06 -	BXW	4	1,1	ZFR6T-11G	5960		ZFR6T-11G
Altea 1.4	5P1	1.4	63	05.10 -	CGGB	4	1,1	ZFR6T-11G	5960		ZFR6T-11G
Altea 1.4 FSI	5P1	1.4	92	11.07 -	CAXC	4	0,9	PZFR6R	5758		PZFR6R
Altea 1.6	5P1	1.6	75	03.04 - 05.05	BGU	4		BKUR6ET-10	2397	24	LPG 1
Altea 1.6	5P1	1.6	75	05.05 -	BSE	4		BKUR6ET-10	2397	24	LPG 1
Altea 1.6	5P1	1.6	75	05.05 - 09	BSF	4		BKUR6ET-10	2397	24	LPG 1
Altea 1.6	5P1	1.6	75	12.07 -	CCSA	4		BKUR6ET-10	2397	24	LPG 1
Altea 1.6 LPG	5P1	1.6	75	09.09 -	CHGA	4		BKUR6ET-10	2397	24	LPG 1
Altea 1.6 TDI	5P1	1.6	77	10.09 -	CAYC	4		Y1002AS	8888	57	
Altea 1.8 TFSI	5P1	1.8	118	01.07 - 06.07	BYT	4	0,8	PFR7S8EG	1675		PFR8S8EG
Altea 1.8 TFSI	5P1	1.8	118	06.07 - 03.09	BZB	4	0,8	PFR7S8EG	1675		PFR8S8EG
Altea 1.8 TFSI	5P1	1.8	118	03.09 -	CDA	4	0,8	PFR7S8EG	1675		PFR8S8EG
Altea 1.9 TDI	5P1	1.9	66	08.09 -	BXF	4		Y-607AS	7560	50	
Altea 1.9 TDI	5P1	1.9	77	04.04 - 09.05	BJB	4		Y-607AS	7560	50	
Altea 1.9 TDI	5P1	1.9	77	04.04 - 05.06	BKC	4		Y-607AS	7560	50	
Altea 1.9 TDI	5P1	1.9	77	10.05 -	BLS	4		CZ104	9826	52	
Altea 1.9 TDI	5P1	1.9	77	02.06 -	BXE	4		Y-607AS	7560	50	
Altea 2.0 TDI 16V	5P1	2.0	100	04.04 - 05.09	AZV	4		YE14	7768	48	
Altea 2.0 TDI 16V	5P1	2.0	103	03.04 -	BKD	4		YE14	7768	48	
Altea 2.0 TDI	5P1	2.0	103	11.05 -	BMM	4		Y-607AS	7560	50	
Altea 2.0 FSI	5P1	2.0	110	05.04 - 11.05	BLR	4		PZFR5N-11T	7742		PZFR5N-11T
Altea 2.0 FSI	5P1	2.0	110	11.04 - 11.05	BLY	4	0,9	BKR6E	6962	28	LPG 1
Altea 2.0 FSI	5P1	2.0	110	11.05 -	BVY	4		PZFR5N-11T	7742		PZFR5N-11T
Altea 2.0 FSI	5P1	2.0	110	11.05 -	BVZ	4	0,9	BKR6E	6962	28	LPG 1
Altea 2.0 TDI	5P1	2.0	125	02.06 -	BMN	4		CZ304	9864	55	
Altea 2.0 TDI	5P1	2.0	125	03.09 - 09.10	CEGA	4		Y-609AS	5849	49	
Altea 2.0 TFSI	5P1	2.0	147	02.06 - 05.09	BWA	4	0,8	PFR7S8EG	1675		PFR8S8EG
Altea XL 1.6 LPG	5P5	1.6	75	09.09 -	CHGA	4		BKUR6ET-10	2397	24	LPG 1
Altea XL 1.6 TDI	5P5	1.6	77	10.09 -	CAYC	4		Y1002AS	8888	57	
Altea XL 2.0 TFSI 4x4	5P5	2.0	155	05.09 -	CCZB	4	0,8	PFR7S8EG	1675		PFR8S8EG

**AROSA**

Arosa 1.0	6H	1.0	37	02.97 - 09.99	AER	4		BUR6ET	3172	1	LPG 2
Arosa 1.0	6H	1.0	37	08.97 - 06.99	ALL	4		BUR6ET	3172	1	LPG 2
Arosa 1.0	6H	1.0	37	11.98 - 02.00	AHT	4		BKR6ETA-10	7998		
Arosa 1.0	6H	1.0	37	07.99 - 07.00	ALD	4	1,1	PZFR5D-11	7968	34	LPG 6
Arosa 1.0	6H	1.0	37	07.99 - 07.00	ANV	4	1,1	PZFR5D-11	7968	34	LPG 6
Arosa 1.0	6H	1.0	37	07.00 - 06.04	AUC	4	1,1	PZFR5D-11	7968	34	LPG 6
Arosa 1.4	6H	1.4	44	02.97 - 11.97	AEX	4		BUR6ET	3172	1	LPG 2
Arosa 1.4	6H	1.4	44	05.97 - 09.99	AKV	4		BUR6ET	3172	1	LPG 2
Arosa 1.4	6H	1.4	44	12.97 - 08.99	APQ	4		BUR6ET	3172	1	LPG 2
Arosa 1.4	6H	1.4	44	07.99 - 10.00	AKK	4	1,1	PZFR5D-11	7968	34	LPG 6
Arosa 1.4	6H	1.4	44	07.99 - 10.00	ANW	4	1,1	PZFR5D-11	7968	34	LPG 6
Arosa 1.4	6H	1.4	44	09.00 - 06.04	AUD	4	1,1	PZFR5D-11	7968	34	LPG 6
Arosa 1.4	6H	1.4	55	01.98 -	AHW	4		BKUR6ET-10	2397	24	LPG 1
Arosa 1.4 TDI Fgst >6H-2-009 700	6H	1.4	55	09.99 - 06.04	AMF	3		Y-732J	5605	4	
Arosa 1.4 TDI Fgst 6H-2-009 701>	6H	1.4	55	09.99 - 06.04	AMF	3		Y-741U	6943	20	

Fgst = Chassis No.

Code *l* kW

Cyl.

Stock-No.  
**VERNE**  
BY-PROMOTER

LPG/CNG

**SEAT****AROSA**

Arosa 1.4 16V	6H	1.4	74	01.99 - 09.00	AFK	4		BKUR6ET-10	2397	24	LPG 1
Arosa 1.4 16V	6H	1.4	74	01.99 -	ANM	4		BKUR6ET-10	2397	24	LPG 1
Arosa 1.4 16V	6H	1.4	74	10.99 - 09.00	AQQ	4		BKUR6ET-10	2397	24	LPG 1
Arosa 1.4 16V	6H	1.4	74	09.00 - 06.04	AUB	4		BKUR6ET-10	2397	24	LPG 1
Arosa 1.7 SDI	6H	1.7	44	08.97 - 10.03	AKU	4		Y-732J	5605	4	

**CORDOBA**

Cordoba / Vario		1.0	37	09.96 -	AER	4		BUR6ET	3172	1	LPG 2
Cordoba / Vario		1.0	37	08.99 - 08.02	ALD	4	1,1	PZFR5D-11	7968	34	LPG 6
Cordoba / Vario		1.0	37	08.99 - 07.00	ANV	4	1,1	PZFR5D-11	7968	34	LPG 6
Cordoba		1.0	37	07.00 -	AUC	4	1,1	PZFR5D-11	7968	34	LPG 6
Cordoba		1.0	51	05.00 -	AVZ	4		BKUR6ETB-10	5742		
Cordoba 12V		1.2	47	05.05 - 06.06	BME	3	0,9	ZFR5P-G	6893		LPG 6
Cordoba		1.3	40	02.93 - 08.94	2G	4		BUR6ET	3172	1	LPG 2
Cordoba		1.3	40	02.93 - 08.94	AAV	4		BP5ET	2287		LPG 2
Cordoba		1.4	40	01.98 -	ANX	4		BUR6ET	3172	1	LPG 2
Cordoba		1.4	44	09.93 - 12.95	ABD	4		BP5ET	2287		LPG 2
Cordoba / Vario		1.4	44	09.95 - 12.97	AEX	4		BUR6ET	3172	1	LPG 2
Cordoba / Vario		1.4	44	09.97 -	AKV	4		BUR6ET	3172	1	LPG 2
Cordoba / Vario		1.4	44	12.97 - 05.98	APQ	4		BUR6ET	3172	1	LPG 2
Cordoba / Vario		1.4	44	08.99 - 08.02	AKK	4	1,1	PZFR5D-11	7968	34	LPG 6
Cordoba / Vario		1.4	44	05.99 - 08.00	ANW	4	1,1	PZFR5D-11	7968	34	LPG 6
Cordoba / Vario		1.4	44	06.00 -	AUD	4	1,1	PZFR5D-11	7968	34	LPG 6
Cordoba TDI		1.4	51	05.05 -	BNM	3		Y-741U	6943	20	
Cordoba 16V		1.4	55	05.99 - 06.00	APE	4		BKUR6ET-10	2397	24	LPG 1
Cordoba 16V		1.4	55	06.00 -	AUA	4		BKUR6ET-10	2397	24	LPG 1
Cordoba 16 V Automatic		1.4	55	09.02 - 04.04	BBY	4	1,1	PZFR5D-11	7968	34	LPG 6
Cordoba TDI		1.4	55	10.02 - 04.04	AMF	3		Y-741U	6943	20	
Cordoba 16 V		1.4	55	05.04 -	BKY	4		BKUR6ET-10	2397	24	LPG 1
Cordoba 16 V Automatic		1.4	55	05.04 -	BKY	4	1,1	PZFR5D-11	7968	34	LPG 6
Cordoba TDI		1.4	58	05.05 -	BNV	3		Y-741U	6943	20	
Cordoba TDI PD		1.4	59	06.06 - 12.06	BMS	3		CZ104	9826	52	
Cordoba		1.4	63	05.06 -	BXW	4	1,1	ZFR6T-11G	5960		ZFR6T-11G
Cordoba / Vario 16V		1.4	74	06.97 -	AFH	4		BKUR6ET	6437	27	LPG 1
Cordoba / Vario 16V		1.4	74	09.99 - 07.00	AQQ	4		BKUR6ET-10	2397	24	LPG 1
Cordoba / Vario 16V		1.4	74	07.00 -	AUB	4		BKUR6ET-10	2397	24	LPG 1
Cordoba 16 V		1.4	74	05.05 -	BBZ	4		BKUR6ET-10	2397	24	LPG 1
Cordoba		1.6	52	11.93 -	ABM	4		BUR5ET	3377	22	LPG 2
Cordoba		1.6	55	02.93 - 07.94	ABU	4		BUR6ET	3172	1	LPG 2
Cordoba / Vario		1.6	55	09.94 - 09.97	1F	4		BUR5ET	3377	22	LPG 2
Cordoba / Vario		1.6	55	05.97 - 12.98	AEE	4		BUR6ET	3172	1	LPG 2
Cordoba / Vario		1.6	55	09.97 - 08.02	ALM	4		BUR6ET	3172	1	LPG 2
Cordoba		1.6	74			4		BUR5ET	3377	22	LPG 2
Cordoba / Vario		1.6	74	09.95 - 05.98	AFT	4		BKUR6ET-10	2397	24	LPG 1
Cordoba		1.6	74	01.96 -	AEK	4		BKUR5ET	2789	29	LPG 1
Cordoba		1.6	74	05.99 - 08.02	AKL	4		BKUR6ET-10	2397	24	LPG 1
Cordoba / Vario		1.6	74	05.99 - 08.02	AEH	4		BKUR6ET-10	2397	24	LPG 1
Cordoba / Vario		1.6	74	03.00 - 10.00	APF	4		BKUR6ET-10	2397	24	LPG 1
Cordoba / Vario		1.6	74	05.00 -	AUR	4		BKUR6ET-10	2397	24	LPG 1
Cordoba		1.6	77	11.06 -	BTS	4	1,1	ZFR6T-11G	5960		ZFR6T-11G
Cordoba		1.8	55	08.91 -	AAM	4		BUR5ET	3377	22	LPG 2
Cordoba		1.8	66	02.93 - 08.94	ABS	4		BUR6ET	3172	1	LPG 2

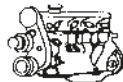

Code *l* kW

Cyl.



Stock-No.



LPG/CNG

**SEAT  
CORDOBA**

Cordoba / Vario		1.8	66	07.94 -	ADZ	4		BUR6ET	3172	1	LPG 2
Cordoba		1.8	66	07.96 -	ACC	4		BUR6ET	3172	1	LPG 2
Cordoba		1.8	95	02.94 - 06.96	ADL	4		BKUR7ET	7873		PFR7Q
Cordoba 16 V		1.8	100			4		BUR6ET	3172	1	LPG 2
Cordoba 20V		1.8	115	12.99 -	AQX	4		BKUR6ET-10	2397	24	LPG 1
Cordoba		1.8	115	09.00 -	AYP	4		BKUR6ET-10	2397	24	LPG 1
Cordoba / Vario D		1.9	47	02.93 -	1Y	4	☑	Y-918J	6285	2	
Cordoba / Vario SDI		1.9	47	07.96 -	AEY	4	☑	Y-732J	5605	4	
Cordoba SDI		1.9	47	09.02 - 04.04	ASY	4	☑	Y-732J	5605	4	
Cordoba SDI		1.9	50	04.99 - 08.02	AGP	4	☑	Y-732J	5605	4	
Cordoba SDI		1.9	50	06.99 - 08.02	AQM	4	☑	Y-732J	5605	4	
Cordoba / Vario TD		1.9	55	02.93 - 08.97	AAZ	4	☑	Y-918J	6285	2	
Cordoba / Vario TDI		1.9	66	07.95 - 12.96	1Z	4	☑	Y-732J	5605	4	
Cordoba / Vario TDI		1.9	66	12.96 -	AHU	4	☑	Y-732J	5605	4	
Cordoba TDI		1.9	66	04.99 - 08.02	AGR	4	☑	Y-732J	5605	4	
Cordoba TDI		1.9	66	10.99 - 05.01	ALH	4	☑	Y-732J	5605	4	
Cordoba TDI		1.9	74	09.02 - 04.04	ATD	4	☑	Y-741U	6943	20	
Cordoba TDI		1.9	74	05.05 -	AXR	4	☑	Y-741U	6943	20	
Cordoba TDI		1.9	74	09.06 - 12.06	BMT	4	☑	CZ104	9826	52	
Cordoba / Vario TDI		1.9	81	03.97 -	AFN	4	☑	Y-732J	5605	4	
Cordoba TDI		1.9	81	03.99 - 08.02	ASV	4	☑	Y-732J	5605	4	
Cordoba TDI		1.9	96	10.02 - 04.04	ASZ	4	☑	Y-741U	6943	20	
Cordoba TDI		1.9	96	05.05 -	BLT	4	☑	Y-741U	6943	20	
Cordoba		2.0	85	02.93 - 06.96	2E	4		BUR6ET	3172	1	LPG 2
Cordoba / Vario		2.0	85	04.96 -	AGG	4		BUR6ET	3172	1	LPG 2
Cordoba		2.0	85	09.02 -	AZL	4		BKUR6ET-10	2397	24	LPG 1
Cordoba		2.0	85	04.03 -	BBX	4		BKUR6ET-10	2397	24	LPG 1
Cordoba 16V		2.0	110	07.96 -	ABF	4		BKUR6ET-10	2397	24	LPG 1

**EXEO**

Exeo 1.6	3R2 / 3R5	1.6	75	03.09 - 09.10	ALZ	4		BKUR6ET-10	2397	24	LPG 1
Exeo 1.8 TSI	3R2 / 3R5	1.8	88	09.10 - 05.13	CDHA	4	0,8	PFR7S8EG	1675		PFR8S8EG
Exeo 1.8 T	3R2 / 3R5	1.8	110	12.08 - 05.10	CFMA	4		BKUR6ET-10	2397	24	LPG 1
Exeo 1.8 TSI	3R2 / 3R5	1.8	118	05.10 - 05.13	CDHB	4	0,8	PFR7S8EG	1675		PFR8S8EG
Exeo 2.0 TDI	3R2 / 3R5	2.0	88	12.08 - 05.13	CAGC	4	☑	Y1002AS	8888	57	
Exeo 2.0 TDI	3R2 / 3R5	2.0	88	12.08 - 05.13	CJCC	4	☑	Y1002AS	8888	57	
Exeo 2.0 TDI	3R2 / 3R5	2.0	105	12.08 - 05.13	CAGA	4	☑	Y1002AS	8888	57	
Exeo 2.0 TDI	3R2 / 3R5	2.0	105	12.08 - 05.13	CJGA	4	☑	Y1002AS	8888	57	
Exeo 2.0 TDI	3R2 / 3R5	2.0	125	02.09 - 05.13	CAHA	4	☑	Y1002AS	8888	57	
Exeo 2.0 TDI	3R2 / 3R5	2.0	125	02.09 - 05.13	CGLB	4	☑	Y1002AS	8888	57	
Exeo 2.0 TFSI	3R2 / 3R5	2.0	147	03.09 - 05.13	BWE	4	0,8	PFR7S8EG	1675		PFR8S8EG
Exeo 2.0 TFSI	3R2 / 3R5	2.0	155	05.10 - 05.13	CDND	4	0,8	PFR7S8EG	1675		PFR8S8EG

**IBIZA 1**

Ibiza 1 0.9	021A	0.9	29	06.84 - 09.93	NCA	4	0,8	BPR6ES	7822	2	LPG 2
Ibiza 1 1,2i	021A	1.2	52	08.89 - 03.93	021-C-1000 Cat.	4	0,9	BCP7ES	5030		BCPR7EIX
Ibiza 1 1,5	021A	1.5	65	04.89 - 08.91	021-D-2000	4	0,9	BCP7ES	5030		BCPR7EIX
Ibiza 1 1,5i	021A	1.5	66	09.87 - 09.93	021-C-2000 Cat.	4	0,9	BCP7ES	5030		BCPR7EIX
Ibiza 1 1,5i SXi	021A	1.5	74	06.88 - 08.91	021-B-2000	4	0,9	BCP7ES	5030		BCPR7EIX
Ibiza 1 1.7 D	021A	1.7	40	09.87 - 05.93	022A5000	4	☑	Y-902R	2237		
Ibiza 1 1.7	021A	1.7	72	02.92 - 05.93	021A3000	4	0,9	BCP7ES	5030		BCPR7EIX

Code *l* kW

Cyl.

Stock-No.  
**VERNE**  
BY-PROMOTER

LPG/CNG

**SEAT****IBIZA 2**

Ibiza 2 1.0	6K1	1.0	33	03.93 - 09.96	AAU	4		BP5ET	2287		LPG 2
Ibiza 2 1.0	6K1	1.0	37	09.96 - 08.99	AER	4		BUR6ET	3172	1	LPG 2
Ibiza 2 1.3	6K1	1.3	40	02.93 - 08.94	2G	4		BP6ET	1263		LPG 2
Ibiza 2 1.3	6K1	1.3	40	02.93 - 08.99	AAV	4		BP5ET	2287		LPG 2
Ibiza 2 1.4	6K1	1.4	44	09.93 - 12.95	ABD	4		BP5ET	2287		LPG 2
Ibiza 2 1.4	6K1	1.4	44	09.95 - 12.97	AEX	4		BUR6ET	3172	1	LPG 2
Ibiza 2 1.4	6K1	1.4	44	09.97 - 08.99	AKV	4		BUR6ET	3172	1	LPG 2
Ibiza 2 1.4	6K1	1.4	44	12.97 - 05.98	APQ	4		BUR6ET	3172	1	LPG 2
Ibiza 2 1.4 16V	6K1	1.4	74	06.97 - 08.99	AFH	4		BKUR6ET	6437	27	LPG 1
Ibiza 2 1.6	6K1	1.6	55	02.93 - 07.94	ABU	4		BUR6ET	3172	1	LPG 2
Ibiza 2 1.6	6K1	1.6	55	09.94 - 09.97	1F	4		BUR5ET	3377	22	LPG 2
Ibiza 2 1.6	6K1	1.6	55	05.97 - 12.98	AEE	4		BUR6ET	3172	1	LPG 2
Ibiza 2 1.6	6K1	1.6	55	09.97 - 05.02	ALM	4		BUR6ET	3172	1	LPG 2
Ibiza 2 1.6	6K1	1.6	74	09.95 - 05.98	AFT	4		BKUR6ET-10	2397	24	LPG 1
Ibiza 2 1.8	6K1	1.8	66	02.93 - 08.94	ABS	4		BUR6ET	3172	1	LPG 2
Ibiza 2 1.8	6K1	1.8	66	07.94 - 08.99	ADZ	4		BUR6ET	3172	1	LPG 2
Ibiza 2 1.8 16V	6K1	1.8	95	02.94 - 06.96	ADL	4		BKUR7ET	7873		PFR7Q
Ibiza 2 1.9 D	6K1	1.9	47	02.93 - 08.96	1Y	4	▣	Y-918J	6285	2	
Ibiza 2 1.9 SDI	6K1	1.9	47	07.96 - 08.99	AEY	4	▣	Y-732J	5605	4	
Ibiza 2 1.9 TD	6K1	1.9	55	02.93 - 08.97	AAZ	4	▣	Y-918J	6285	2	
Ibiza 2 1.9 TDI	6K1	1.9	66	07.96 - 12.96	1Z	4	▣	Y-732J	5605	4	
Ibiza 2 1.9 TDI	6K1	1.9	66	12.96 - 08.99	AHU	4	▣	Y-732J	5605	4	
Ibiza 2 1.9 TDI	6K1	1.9	81	03.97 - 08.99	AFN	4	▣	Y-732J	5605	4	
Ibiza 2 2.0	6K1	2.0	85	02.93 - 06.96	2E	4		BUR6ET	3172	1	LPG 2
Ibiza 2 2.0	6K1	2.0	85	04.96 - 08.99	AGG	4		BUR6ET	3172	1	LPG 2
Ibiza 2 2.0 16V	6K1	2.0	110	07.96 - 08.99	ABF	4		BKUR6ET-10	2397	24	LPG 1

**IBIZA 3**

Ibiza 3 1.0	6K1	1.0	37	08.99 - 05.02	ALD	4	1,1	PZFR5D-11	7968	34	LPG 6
Ibiza 3 1.0	6K1	1.0	37	08.99 - 07.00	ANV	4	1,1	PZFR5D-11	7968	34	LPG 6
Ibiza 3 1.0	6K1	1.0	37	07.00 - 05.02	AUC	4	1,1	PZFR5D-11	7968	34	LPG 6
Ibiza 3 1.4	6K1	1.4	44	08.99 - 05.02	AKK	4	1,1	PZFR5D-11	7968	34	LPG 6
Ibiza 3 1.4	6K1	1.4	44	05.99 - 08.00	ANW	4	1,1	PZFR5D-11	7968	34	LPG 6
Ibiza 3 1.4	6K1	1.4	44	06.00 - 05.02	AUD	4	1,1	PZFR5D-11	7968	34	LPG 6
Ibiza 3 1.4 16V	6K1	1.4	55	09.99 - 06.00	APE	4		BKUR6ET-10	2397	24	LPG 1
Ibiza 3 1.4 16V	6K1	1.4	55	06.00 - 05.02	AUA	4		BKUR6ET-10	2397	24	LPG 1
Ibiza 3 1.4 16V	6K1	1.4	74	09.99 - 07.00	AQQ	4		BKUR6ET-10	2397	24	LPG 1
Ibiza 3 1.4 16V	6K1	1.4	74	07.00 - 05.02	AUB	4		BKUR6ET-10	2397	24	LPG 1
Ibiza 3 1.6	6K1	1.6	74	05.99 - 05.02	AEH	4		BKUR6ET-10	2397	24	LPG 1
Ibiza 3 1.6	6K1	1.6	74	06.99 - 05.02	AKL	4		BKUR6ET-10	2397	24	LPG 1
Ibiza 3 1.6	6K1	1.6	74	03.00 - 02.02	APF	4		BKUR6ET-10	2397	24	LPG 1
Ibiza 3 1.6	6K1	1.6	74	05.00 - 05.02	AUR	4		BKUR6ET-10	2397	24	LPG 1
Ibiza 3 1.8T 20V Cupra	6K1	1.8	115	12.99 - 02.02	AQX	5		BKUR6ET-10	2397	24	LPG 1
Ibiza 3 1.8T 20V Cupra	6K1	1.8	115	05.00 - 05.02	AYP	5		BKUR6ET-10	2397	24	LPG 1
Ibiza 3 1.9 SDI	6K1	1.9	50	04.99 - 05.02	AGP	4	▣	Y-732J	5605	4	
Ibiza 3 1.9 SDI	6K1	1.9	50	05.99 - 05.02	AQM	4	▣	Y-732J	5605	4	
Ibiza 3 1.9 TDI	6K1	1.9	66	04.99 - 05.02	AGR	4	▣	Y-732J	5605	4	
Ibiza 3 1.9 TDI	6K1	1.9	66	05.99 - 05.02	ALH	4	▣	Y-732J	5605	4	
Ibiza 3 1.9 TDI	6K1	1.9	81	03.99 - 05.02	ASV	4	▣	Y-732J	5605	4	

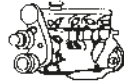
Code *l* kW

Cyl.

Stock-No.  
**VLIVE**  
10-14-15-16-17-18-19-20-21

LPG/CNG

**SEAT  
IBIZA 4**

Ibiza 4 1.2	6L1	1.2	44	06.07 - 05.08	BBM	3	0,9	ZFR5P-G	6893		LPG 6
Ibiza 4 1.2	6L1	1.2	47	01.02 - 06.06	AZQ	3	0,9	ZFR5P-G	6893		LPG 6
Ibiza 4 1.2	6L1	1.2	47	05.05 - 06.06	BME	3	0,9	ZFR5P-G	6893		LPG 6
Ibiza 4 1.2 12V	6L1	1.2	51	05.06 - 11.09	BXV	3	0,9	ZFR5P-G	6893		LPG 6
Ibiza 4 1.4 12V	6L1	1.4	55	01.02 - 04.04	BBY	4		BKUR6ET-10	2397	24	LPG 1
Ibiza 4 1.4 12V	6L1	1.4	55	05.04 - 06.06	BKY	4		BKUR6ET-10	2397	24	LPG 1
Ibiza 4 1.4 12V Automatic	6L1	1.4	55	01.02 - 04.04	BBY	4	1,1	PZFR5D-11	7968	34	LPG 6
Ibiza 4 1.4 12V Automatic	6L1	1.4	55	05.04 - 06.06	BKY	4	1,1	PZFR5D-11	7968	34	LPG 6
Ibiza 4 1.4 TDI	6L1	1.4	51	05.05 - 11.09	BNM	3	☑	Y-741U	6943	20	
Ibiza 4 1.4 TDI	6L1	1.4	55	05.05 - 12.05	AMF	3	☑	Y-741U	6943	20	
Ibiza 4 1.4 TDI	6L1	1.4	59	05.05 - 11.09	BNV	3	☑	Y-741U	6943	20	
Ibiza 4 1.4 16V	6L1	1.4	74	04.02 - 11.09	BBZ	4		BKUR6ET-10	2397	24	LPG 1
Ibiza 4 1.6	6L1	1.6	74	01.07 - 11.09	BAH	4	1,1	PZFR5D-11	7968	34	LPG 6
Ibiza 4 1.8T FR	6L1	1.8	110	12.03 - 05.08	BJX	4	0,8	PFR6Q	6458	37	LPG 1
Ibiza 4 1.8T FR	6L1	1.8	110	12.03 - 05.08	BKV	4	0,8	PFR6Q	6458	37	LPG 1
Ibiza 4 1.8T Cupra R	6L1	1.8	132	05.04 - 02.08	BBU	4	0,8	PFR6Q	6458	37	LPG 1
Ibiza 4 1.9 SDI	6L1	1.9	47	05.05 - 12.05	ASY	4	☑	Y-732J	5605	4	
Ibiza 4 1.9 TDI	6L1	1.9	74	09.06 - 11.09	BMT	4	☑	CZ104	9826	52	
Ibiza 4 1.9 TDI	6L1	1.9	74	05.05 - 11.09	AXR	4	☑	Y-741U	6943	20	
Ibiza 4 1.9 TDI	6L1	1.9	96	05.05 - 11.09	BLT	4	☑	Y-741U	6943	20	
Ibiza 4 1.9 TDI Fgst 6L-2-001 501>	6L1	1.9	74	05.05 - 05.05	ATD	4	☑	Y-741U	6943	20	
Ibiza 4 1.9 TDI Fgst 6L-2-001 501>	6L1	1.9	96	05.05 - 09.05	ASZ	4	☑	Y-741U	6943	20	
Ibiza 4 1.9 TDI Cupra R	6L1	1.9	118	03.04 - 02.08	BPX	4	☑	Y-741U	6943	20	
Ibiza 4 1.9 TDI Cupra R	6L1	1.9	118	11.05 - 02.08	BUK	4	☑	Y-741U	6943	20	
Ibiza 4 2.0	6L1	2.0	85	07.02 - 04.04	AZL	4		BKUR6ET-10	2397	24	LPG 1
Ibiza 4 2.0	6L1	2.0	85	04.03 - 11.09	BBX	4		BKUR6ET-10	2397	24	LPG 1

**IBIZA 5**

Ibiza 5 1.2	6J5	1.2	44	07.09 -	CGPB	3	1,1	ZFR6T-11G	5960		ZFR6T-11G
Ibiza 5 1.2	6J5	1.2	51	03.08 -	BZG	3	0,9	ZFR5P-G	6893		LPG 6
Ibiza 5 1.2	6J5	1.2	51	05.09 -	CGPA	3	0,9	ZFR6T-11G	5960		ZFR6T-11G
Ibiza 5 1.2 TDI	6J5	1.2	55	05.10 -	CFWA	3	☑	Y1002AS	8888	57	
Ibiza 5 1.2 TSI	6J5	1.2	77	09.10 -	CBZB	4	0,7	IZFR6P7	97153		IZFR6P7
Ibiza 5 1.4	6J5	1.4	63	05.06 -	BXW	4	1,1	ZFR6T-11G	5960		ZFR6T-11G
Ibiza 5 1.4	6J5	1.4	63	07.08 -	CGGB	4	1,1	ZFR6T-11G	5960		ZFR6T-11G
Ibiza 5 1.4 TDI	6J5	1.4	59	07.08 - 06.10	BMS	3	☑	CZ104	9826	52	
Ibiza 5 1.4 TSI	6J5	1.4	110	06.09 -	CAVF	4	0,8	PZFR6R8EG	96498		PZFR6R8EG
Ibiza 5 1.4 TSI	6J5	1.4	132	05.09 -	CAVE	4	0,8	PZFR6R8EG	96498		PZFR6R8EG
Ibiza 5 1.6	6J5	1.6	77	11.06 -	BTS	4	1,1	ZFR6T-11G	5960		ZFR6T-11G
Ibiza 5 1.6 TDI	6J5	1.6	66	05.09 -	CAYB	4	☑	Y1002AS	8888	57	
Ibiza 5 1.6 TDI	6J5	1.6	77	05.09 -	CAYC / CLNA	4	☑	Y1002AS	8888	57	
Ibiza 5 1.9 TDI	6J5	1.9	66	06.08 - 06.10	BXJ	4	☑	Y-607AS	7560	50	
Ibiza 5 1.9 TDI	6J5	1.9	77	02.08 - 06.10	BLS	4	☑	Y-607AS	7560	50	
Ibiza 5 2.0 TDI	6J5	2.0	105	01.10 -	CFHD	4	☑	Y1002AS	8888	57	

**INCA**

Inca	6K9	1.4	44	11.95 - 12.97	AEX	4		BUR6ET	3172	1	LPG 2
Inca	6K9	1.4	44	12.97 - 09.00	AKV	4		BUR6ET	3172	1	LPG 2
Inca	6K9	1.4	44	12.97 - 06.03	APQ	4		BUR6ET	3172	1	LPG 2
Inca	6K9	1.4	44	09.00 - 06.03	AUD	4	1,1	PZFR5D-11	7968	34	LPG 6
Inca 16V	6K9	1.4	55	09.00 - 06.03	AUA	4		BKUR6ET-10	2397	24	LPG 1

Fgst = Chassis No.

Code *l* kW

Cyl.

Stock-No.  
**VERNE**  
BY-PROMOTER

LPG/CNG

**SEAT****INCA**

Inca	6K9	1.6	55	11.95 - 05.97	1F	4		BUR5ET	3377	22	LPG 2
Inca	6K9	1.6	55	06.97 - 09.00	AEE	4		BUR6ET	3172	1	LPG 2
Inca D	6K9	1.7	42	07.96 - 09.00	AHB	4	▣	Y-918J	6285	2	
Inca D	6K9	1.9	47	11.95 - 06.03	1Y	4	▣	Y-918J	6285	2	
Inca SDI	6K9	1.9	47	11.95 - 09.00	AEY	4	▣	Y-732J	5605	4	
Inca SDI	6K9	1.9	47	09.00 - 06.03	AYQ	4	▣	Y-732J	5605	4	

**LEÓN 1**

León 1 1.4 16V	1M1	1.4	55	11.99 - 05.00	APE	4		BKUR6ET-10	2397	24	LPG 1
León 1 1.4 16V	1M1	1.4	55	01.00 - 05.02	AHW	4		BKUR6ET-10	2397	24	LPG 1
León 1 1.4 16V	1M1	1.4	55	06.00 - 02.02	AXP	4		BKUR6ET-10	2397	24	LPG 1
León 1 1.4 16V	1M1	1.4	55	02.02 - 10.05	BCA	4		BKUR6ET-10	2397	24	LPG 1
León 1 1.6	1M1	1.6	74	11.98 - 10.05	AEH	4		BKUR6ET-10	2397	24	LPG 1
León 1 1.6	1M1	1.6	74	10.98 - 10.05	AKL	4		BKUR6ET-10	2397	24	LPG 1
León 1 1.6	1M1	1.6	75	10.05 -	BFQ	4		BKUR6ET-10	2397	24	LPG 1
León 1 1.6 16V	1M1	1.6	77	11.99 -	ATN	4		BKUR6ET-10	2397	24	LPG 1
León 1 1.6 16V	1M1	1.6	77	06.00 - 04.01	AUS	4		BKUR6ET-10	2397	24	LPG 1
León 1 1.6 16V	1M1	1.6	77	05.01 - 04.02	AZD	4	1,1	PZFR6J-11	3586		LPG 6
León 1 1.6 16V	1M1	1.6	77	04.02 - 06.06	BCB	4	1,1	PZFR6J-11	3586		LPG 6
León 1 1.8 20V	1M1	1.8	92	10.98 - 12.03	AGN	4		BKUR6ET-10	2397	24	LPG 1
León 1 1.8 20V	1M1	1.8	92	06.00 - 10.05	APG	4		BKUR6ET-10	2397	24	LPG 1
León 1 1.8 20V T	1M1	1.8	132	11.99 -	APP	4	0,8	PFR6Q	6458	37	LPG 1
León 1 1.8 20V T	1M1	1.8	132	09.00 - 10.05	AUQ	4	0,8	PFR6Q	6458	37	LPG 1
León 1 1.8 20V T	1M1	1.8	132	05.01 - 10.05	AUQ	4	0,8	PFR6Q	6458	37	LPG 1
León 1 1.8 20V T4	1M1	1.8	132	04.00 -	AJQ	4	0,8	PFR6Q	6458	37	LPG 1
León 1 1.8 20V T4	1M1	1.8	132	09.00 - 04.04	ARY	4	0,8	PFR6Q	6458	37	LPG 1
León 1 1.8T Cupra R	1M1	1.8	154	05.02 - 05.03	AMK	4	0,8	PFR6Q	6458	37	LPG 1
León 1 1.8T Cupra R	1M1	1.8	165	05.03 -	BAM	4	0,8	PFR6Q	6458	37	LPG 1
León 1 1.9 SDI	1M1	1.9	50	03.00 - 10.03	AQM	4	▣	Y-732J	5605	4	
León 1 1.9 TDI	1M1	1.9	66	04.99 - 09.02	AGR	4	▣	Y-732J	5605	4	
León 1 1.9 TDI	1M1	1.9	66	03.99 - 10.05	ALH	4	▣	Y-732J	5605	4	
León 1 1.9 TDI	1M1	1.9	81	10.98 - 09.02	AHF	4	▣	Y-732J	5605	4	
León 1 1.9 TDI	1M1	1.9	81	11.99 - 10.05	ASV	4	▣	Y-732J	5605	4	
León 1 1.9 TDI	1M1	1.9	96	05.03 - 06.06	ASZ	4	▣	Y-741U	6943	20	
León 1 1.9 TDI Fgst >1M-2-062000	1M1	1.9	110	09.00 -	ARL	4	▣	Y-732J	5605	4	
León 1 1.9 TDI Fgst 1M-2-062001 >	1M1	1.9	110	09.00 - 12.05	ARL	4	▣	Y-741U	6943	20	
León 1 2.8 Cupra 4	1M1	2.8	150	05.01 - 07.01	AUE	6	1,1	PZFR5D-11	7968	34	LPG 6

**LEÓN 2**

León 2 1.2 TSI	1P1	1.2	77	02.10 -	CBZB	4	0,7	IZFR6P7	97153		IZFR6P7
León 2 1.4 16V	1P1	1.4	63	06.06 -	BXW	4	1,1	ZFR6T-11G	5960		ZFR6T-11G
León 2 1.4 16V	1P1	1.4	63	05.10 -	CGGB	4	0,8	PZFR6R8EG	96498		PZFR6R8EG
León 2 1.4 TFSI	1P1	1.4	92	11.07 -	CAXC	4	0,9	PZFR6R	5758		PZFR6R
León 2 1.6	1P1	1.6	75	07.05 -	BSE	4		BKUR6ET-10	2397	24	LPG 1
León 2 1.6	1P1	1.6	75	07.05 -	BSF	4		BKUR6ET-10	2397	24	LPG 1
León 2 1.6	1P1	1.6	75	10.09 -	CCSA	4		BKUR6ET-10	2397	24	LPG 1
León 2 1.6 LPG	1P1	1.6	75	12.09 -	CHGA	4		BKUR6ET-10	2397	24	LPG 1
León 2 1.6 TDI	1P1	1.6	77	02.10 -	CAYC	4	▣	Y1002AS	8888	57	
León 2 1.8 TFSI	1P1	1.8	118	05.07 - 03.09	BZB	4	0,8	PFR7S8EG	1675		PFR7S8EG
León 2 1.8 TFSI	1P1	1.8	118	03.09 -	CDAA	4	0,8	PFR7S8EG	1675		PFR7S8EG
León 2 1.9 TDI	1P1	1.9	66	06.07 -	BXF	4	▣	Y-607AS	7560	50	
León 2 1.9 TDI	1P1	1.9	77	07.05 - 02.06	BKC	4	▣	Y-607AS	7560	50	

Fgst = Chassis No.

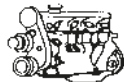
Code *l* kW

Cyl.



Stock-No.



10-15-17-19-20-21-22-23-24-25-26-27-28-29-30-31-32-33-34-35-36-37-38-39-40-41-42-43-44-45-46-47-48-49-50-51-52-53-54-55-56-57-58-59-60-61-62-63-64-65-66-67-68-69-70-71-72-73-74-75-76-77-78-79-80-81-82-83-84-85-86-87-88-89-90-91-92-93-94-95-96-97-98-99-100-101-102-103-104-105-106-107-108-109-110-111-112-113-114-115-116-117-118-119-120-121-122-123-124-125-126-127-128-129-130-131-132-133-134-135-136-137-138-139-140-141-142-143-144-145-146-147-148-149-150-151-152-153-154-155-156-157-158-159-160-161-162-163-164-165-166-167-168-169-170-171-172-173-174-175-176-177-178-179-180-181-182-183-184-185-186-187-188-189-190-191-192-193-194-195-196-197-198-199-200-201-202-203-204-205-206-207-208-209-210-211-212-213-214-215-216-217-218-219-220-221-222-223-224-225-226-227-228-229-230-231-232-233-234-235-236-237-238-239-240-241-242-243-244-245-246-247-248-249-250-251-252-253-254-255-256-257-258-259-260-261-262-263-264-265-266-267-268-269-270-271-272-273-274-275-276-277-278-279-280-281-282-283-284-285-286-287-288-289-290-291-292-293-294-295-296-297-298-299-300-301-302-303-304-305-306-307-308-309-310-311-312-313-314-315-316-317-318-319-320-321-322-323-324-325-326-327-328-329-330-331-332-333-334-335-336-337-338-339-340-341-342-343-344-345-346-347-348-349-350-351-352-353-354-355-356-357-358-359-360-361-362-363-364-365-366-367-368-369-370-371-372-373-374-375-376-377-378-379-380-381-382-383-384-385-386-387-388-389-390-391-392-393-394-395-396-397-398-399-400-401-402-403-404-405-406-407-408-409-410-411-412-413-414-415-416-417-418-419-420-421-422-423-424-425-426-427-428-429-430-431-432-433-434-435-436-437-438-439-440-441-442-443-444-445-446-447-448-449-450-451-452-453-454-455-456-457-458-459-460-461-462-463-464-465-466-467-468-469-470-471-472-473-474-475-476-477-478-479-480-481-482-483-484-485-486-487-488-489-490-491-492-493-494-495-496-497-498-499-500-501-502-503-504-505-506-507-508-509-510-511-512-513-514-515-516-517-518-519-520-521-522-523-524-525-526-527-528-529-530-531-532-533-534-535-536-537-538-539-540-541-542-543-544-545-546-547-548-549-550-551-552-553-554-555-556-557-558-559-560-561-562-563-564-565-566-567-568-569-570-571-572-573-574-575-576-577-578-579-580-581-582-583-584-585-586-587-588-589-590-591-592-593-594-595-596-597-598-599-600-601-602-603-604-605-606-607-608-609-610-611-612-613-614-615-616-617-618-619-620-621-622-623-624-625-626-627-628-629-630-631-632-633-634-635-636-637-638-639-640-641-642-643-644-645-646-647-648-649-650-651-652-653-654-655-656-657-658-659-660-661-662-663-664-665-666-667-668-669-670-671-672-673-674-675-676-677-678-679-680-681-682-683-684-685-686-687-688-689-690-691-692-693-694-695-696-697-698-699-700-701-702-703-704-705-706-707-708-709-710-711-712-713-714-715-716-717-718-719-720-721-722-723-724-725-726-727-728-729-730-731-732-733-734-735-736-737-738-739-740-741-742-743-744-745-746-747-748-749-750-751-752-753-754-755-756-757-758-759-760-761-762-763-764-765-766-767-768-769-770-771-772-773-774-775-776-777-778-779-780-781-782-783-784-785-786-787-788-789-790-791-792-793-794-795-796-797-798-799-800-801-802-803-804-805-806-807-808-809-810-811-812-813-814-815-816-817-818-819-820-821-822-823-824-825-826-827-828-829-830-831-832-833-834-835-836-837-838-839-840-841-842-843-844-845-846-847-848-849-850-851-852-853-854-855-856-857-858-859-860-861-862-863-864-865-866-867-868-869-870-871-872-873-874-875-876-877-878-879-880-881-882-883-884-885-886-887-888-889-890-891-892-893-894-895-896-897-898-899-900-901-902-903-904-905-906-907-908-909-910-911-912-913-914-915-916-917-918-919-920-921-922-923-924-925-926-927-928-929-930-931-932-933-934-935-936-937-938-939-940-941-942-943-944-945-946-947-948-949-950-951-952-953-954-955-956-957-958-959-960-961-962-963-964-965-966-967-968-969-970-971-972-973-974-975-976-977-978-979-980-981-982-983-984-985-986-987-988-989-990-991-992-993-994-995-996-997-998-999-1000

LPG/CNG

**SEAT  
LEÓN 2**

León 2 1.9 TDI	1P1	1.9	77	11.05 -	BLS	4	☑	CZ104	9826	52	
León 2 1.9 TDI	1P1	1.9	77	02.06 -	BXE	4	☑	Y-607AS	7560	50	
León 2 2.0 FSI	1P1	2.0	110	07.05 - 11.05	BLR	4		PZFR5N-11T	7742		PZFR5N-11T
León 2 2.0 FSI	1P1	2.0	110	07.05 - 11.05	BLY	4		PZFR5N-11T	7742		PZFR5N-11T
León 2 2.0 FSI	1P1	2.0	110	11.05 - 03.09	BVY	4		PZFR5N-11T	7742		PZFR5N-11T
León 2 2.0 FSI	1P1	2.0	110	11.05 -	BVZ	4		PZFR5N-11T	7742		PZFR5N-11T
León 2 2.0 TDI	1P1	2.0	100	07.05 - 03.09	AZV	4	☑	YE14	7768	48	
León 2 2.0 TDI	1P1	2.0	103	10.05 -	BMM	4	☑	Y-607AS	7560	50	
León 2 2.0 TDI	1P1	2.0	125	05.06 - 03.09	BMN	4	☑	CZ304	9864	55	
León 2 2.0 TDI	1P1	2.0	125	03.09 - 09.10	CEGA	4	☑	Y-609AS	5849	49	
León 2 2.0 TDI 16V	1P1	2.0	103	07.05 -	BKD	4	☑	YE14	7768	48	
León 2 2.0 TFSI	1P1	2.0	136	10.05 - 05.06	BWA1	4	0,8	PFR7S8EG	1675		PFR8S8EG
León 2 2.0 TFSI	1P1	2.0	147	05.05 - 03.09	BWA	4	0,8	PFR7S8EG	1675		PFR8S8EG
León 2 2.0 TFSI	1P1	2.0	155	06.09 -	CCZB	4	0,8	PFR7S8EG	1675		PFR8S8EG
León 2 2.0 TFSI	1P1	2.0	177	11.06 - 05.09	BWJ	4	0,8	PFR7S8EG	1675		PFR8S8EG
León 2 2.0 TFSI	1P1	2.0	177	06.09 -	CDLD	4	0,8	PFR7S8EG	1675		PFR8S8EG
León 2 2.0 TFSI Cupra R	1P1	2.0	195	09.09 -	CDLA	4	0,8	PFR7S8EG	1675		PFR8S8EG

**LEÓN 3**

León 3 1.6 TDI	5F1	1.6	66	11.12 -	CLHB	4	☑	Y1002AS	8888	57	
ohne Drucksensor Euro V											
León 3 1.6 TDI	5F1	1.6	77	09.12 -	CLHA	4	☑	Y1002AS	8888	57	
ohne Drucksensor Euro V											
León 3 2.0 TDI	5F1	2.0	110	10.12 -	CKFC	4	☑	Y1002AS	8888	57	
ohne Drucksensor Euro V											
León 3 2.0 TDI	5F1	2.0	110	10.12 -	CRMB	4	☑	Y1002AS	8888	57	
ohne Drucksensor Euro V											
León 3 2.0 TDI	5F1	2.0	135	09.12 -	CUPA	4	☑	Y1002AS	8888	57	
ohne Drucksensor Euro V											

**MARBELLA**

Marbella 0,9		0,9	30	92 - 05.98	09NCB Cat.	4	0,9	BPR5ES	7422	6	LPG 2
--------------	--	-----	----	------------	------------	---	-----	--------	------	---	-------

**TERRA**

Terra 0,9		0,9	29	08.91 - 05.98	09NCB Cat.	4	0,9	BPR5ES	7422	6	LPG 2
Terra D		1.4	35	01.90 -		4	☑	Y-918J	6285	2	
Terra D		1.4	35	10.90 -		4	☑	Y-918J	6285	2	
Terra Kombi D		1.4		10.91 -	1W	4	☑	Y-918J	6285	2	

**TOLEDO 1**

Toledo 1 1.6	1L	1.6	52	11.93 - 10.99	ABN	4		BUR5ET	3377	22	LPG 2
Toledo 1 1.6	1L	1.6	54	08.91 - 10.99	EZ	4		BUR5ET-10	7264	21	LPG 2
Toledo 1 1.6	1L	1.6	55	11.93 - 03.99	1F	4		BUR5ET	3377	22	LPG 2
Toledo 1 1.6	1L	1.6	55	03.93 -	ABU	4		BUR6ET	3172	1	LPG 2
Toledo 1 1.6	1L	1.6	74	04.96 - 03.99	AFT	4		BKUR6ET-10	2397	24	LPG 1
Toledo 1 1.8	1L	1.8	66	05.91 - 07.94	ABS	4		BUR6ET	3172	1	LPG 2
Toledo 1 1.8	1L	1.8	66	08.91 - 12.92	RP	4		BUR6ET	3172	1	LPG 2
Toledo 1 1.8	1L	1.8	66	11.94 - 05.99	ADZ	4		BUR6ET	3172	1	LPG 2
Toledo 1 1.8	1L	1.8	66	01.95 -	ACC	4		BUR6ET	3172	1	LPG 2
Toledo 1 1.8 16V	1L	1.8	92	08.91 - 05.94	PL	4		BKUR7ET	7873		PFR7Q
Toledo 1 1.8 16V	1L	1.8	98	08.91 -	KR	4		BCPR7ET	2164		BCPR7EIX
Toledo 1 1.9 D	1L	1.9	47	03.91 - 03.99	1Y	4	☑	Y-918J	6285	2	
Toledo 1 1.9 TD	1L	1.9	55	03.91 - 04.97	AAZ	4	☑	Y-918J	6285	2	



Code *l* kW

Cyl.

Stock-No.  
**VERNE**  
BY-PROMOTER

LPG/CNG

**SEAT****TOLEDO 1**

Toledo 1 1.9 TDI	1L	1.9	66	08.93 - 12.96	1Z	4		Y-732J	5605	4	
Toledo 1 1.9 TDI	1L	1.9	81	12.96 - 03.99	AFN	4		Y-732J	5605	4	
Toledo 1 2.0	1L	2.0	85	05.91 -	2E	4		BUR6ET	3172	1	LPG 2
Toledo 1 2.0	1L	2.0	85	07.95 - 03.99	AGG	4		BUR6ET	3172	1	LPG 2
Toledo 1 2.0 16V	1L	2.0	100		9A	4		BKUR7ET	7873		PFR7Q
Toledo 1 2.0 16V	1L	2.0	110	05.94 - 03.99	ABF	4		BKUR6ET-10	2397	24	LPG 1

**TOLEDO 2**

Toledo 2 1.4 16V	1M2	1.4	55	11.99 -	APE	4		BKUR6ET-10	2397	24	LPG 1
Toledo 2 1.4 16V	1M2	1.4	55	01.00 - 05.02	AHW	4		BKUR6ET-10	2397	24	LPG 1
Toledo 2 1.4 16V	1M2	1.4	55	06.00 -	AXP	4		BKUR6ET-10	2397	24	LPG 1
Toledo 2 1.4 16V	1M2	1.4	55	02.02 - 10.05	BCA	4		BKUR6ET-10	2397	24	LPG 1
Toledo 2 1.6	1M2	1.6	74	01.96 - 03	AEK	4		BKUR5ET	2789	29	LPG 1
Toledo 2 1.6	1M2	1.6	74	11.98 - 10.05	AEH	4		BKUR6ET-10	2397	24	LPG 1
Toledo 2 1.6	1M2	1.6	74	02.99 - 10.05	AKL	4		BKUR6ET-10	2397	24	LPG 1
Toledo 2 1.6	1M2	1.6	74	09.99 -	APF	4		BKUR6ET-10	2397	24	LPG 1
Toledo 2 1.6	1M2	1.6	75	10.05 -	BFQ	4		BKUR6ET-10	2397	24	LPG 1
Toledo 2 1.6	1M2	1.6	77	11.99 -	ATN	4		BKUR6ET-10	2397	24	LPG 1
Toledo 2 1.6 16V	1M2	1.6	77	06.00 -	AUS	4		BKUR6ET-10	2397	24	LPG 1
Toledo 2 1.6 16V	1M2	1.6	77	09.00 - 04.02	AZD	4		BKUR6ET-10	2397	24	LPG 1
Toledo 2 1.6 16V	1M2	1.6	77	04.02 - 05.06	BCB	4	1,1	PZFR6J-11	3586		LPG 6
Toledo 2 1.8 20V	1M2	1.8	92	10.98 - 12.03	AGN	4		BKUR6ET-10	2397	24	LPG 1
Toledo 2 1.8 20V	1M2	1.8	92	09.00 - 10.05	APG	4		BKUR6ET-10	2397	24	LPG 1
Toledo 2 1.8 20V Cupra R	1M2	1.8	154	05.02 - 05.03	AMK	4	0,8	PFR6Q	6458	37	LPG 1
Toledo 2 1.8 20V Cupra R	1M2	1.8	165	05.03 -	BAM	4	0,8	PFR6Q	6458	37	LPG 1
Toledo 2 1.8 20V T	1M2	1.8	132	11.99 -	APP	4	0,8	PFR6Q	6458	37	LPG 1
Toledo 2 1.8 20V T	1M2	1.8	132	03.00 - 01.01	AJQ	4	0,8	PFR6Q	6458	37	LPG 1
Toledo 2 1.8 20V T	1M2	1.8	132	05.01 - 04.04	ARY	4	0,8	PFR6Q	6458	37	LPG 1
Toledo 2 1.8 20V T	1M2	1.8	132	05.01 - 10.05	AUQ	4	0,8	PFR6Q	6458	37	LPG 1
Toledo 2 1.9 SDI	1M2	1.9	50	05.01 - 10.03	AQM	4		Y-732J	5605	4	
Toledo 2 1.9 TDI	1M2	1.9	66	05.99 - 09.02	AGR	4		Y-732J	5605	4	
Toledo 2 1.9 TDI	1M2	1.9	66	03.99 - 10.05	ALH	4		Y-732J	5605	4	
Toledo 2 1.9 TDI	1M2	1.9	81	05.99 - 09.02	AHF	4		Y-732J	5605	4	
Toledo 2 1.9 TDI	1M2	1.9	81	10.99 - 10.05	ASV	4		Y-732J	5605	4	
Toledo 2 1.9 TDI	1M2	1.9	110	10.00 - 12.05	ARL	4		Y-732J	5605	4	
Toledo 2 2.0	1M2	2.0	85	06.99 -	AQY	4		BKUR6ET-10	2397	24	LPG 1
Toledo 2 2.3 V5	1M2	2.3	110	10.98 - 11.00	AGZ	5		BKR5EKUP	2890		
Toledo 2 2.3 V5 20V	1M2	2.3	125	09.00 - 11.03	AQN	5	1,1	PZFR5D-11	7968	34	LPG 6
Toledo 2 2.8 V6	1M2	2.8	150	05.01 -	AUE	6	1,1	PZFR5D-11	7968	34	LPG 6
Toledo 2 2.8 V6	1M2	2.8	150	05.02 - 04.04	BDE	6	1,1	PZFR5D-11	7968	34	LPG 6

**TOLEDO 3**

Toledo 3 1.4 TFSI	5P2	1.4	92	11.07 - 05.09	CAXC	4	0,9	PZFR6R	5758		PZFR6R
Toledo 3 1.6	5P2	1.6	75	09.04 - 05.05	BGU	4		BKUR6ET-10	2397	24	LPG 1
Toledo 3 1.6	5P2	1.6	75	05.05 -	BSE	4		BKUR6ET-10	2397	24	LPG 1
Toledo 3 1.6	5P2	1.6	75	05.05 - 05.07	BSF	4		BKUR6ET-10	2397	24	LPG 1
Toledo 3 1.6	5P2	1.6	75	12.07 -	CCSA	4		BKUR6ET-10	2397	24	LPG 1
Toledo 3 1.8 TFSI	5P2	1.8	118	01.07 - 06.07	BYT	4	0,8	PFR7S8EG	1675		PFR8S8EG
Toledo 3 1.8 TFSI	5P2	1.8	118	06.07 - 03.09	BZB	4	0,8	PFR7S8EG	1675		PFR8S8EG
Toledo 3 1.8 TFSI	5P2	1.8	118	03.09 - 05.09	CDAA	4	0,8	PFR7S8EG	1675		PFR8S8EG
Toledo 3 1.9 TDI	5P2	1.9	77	09.04 - 09.05	BJB	4		Y-607AS	7560	50	

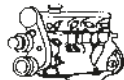
Code *ℓ* kW

Cyl.

Stock-No.  
**VELINE**  
10-17-19-20-21-22-23-24-25-26-27-28-29-30-31-32-33-34-35-36-37-38-39-40-41-42-43-44-45-46-47-48-49-50-51-52-53-54-55-56-57-58-59-60-61-62-63-64-65-66-67-68-69-70-71-72-73-74-75-76-77-78-79-80-81-82-83-84-85-86-87-88-89-90-91-92-93-94-95-96-97-98-99-100-101-102-103-104-105-106-107-108-109-110-111-112-113-114-115-116-117-118-119-120-121-122-123-124-125-126-127-128-129-130-131-132-133-134-135-136-137-138-139-140-141-142-143-144-145-146-147-148-149-150-151-152-153-154-155-156-157-158-159-160-161-162-163-164-165-166-167-168-169-170-171-172-173-174-175-176-177-178-179-180-181-182-183-184-185-186-187-188-189-190-191-192-193-194-195-196-197-198-199-200-201-202-203-204-205-206-207-208-209-210-211-212-213-214-215-216-217-218-219-220-221-222-223-224-225-226-227-228-229-230-231-232-233-234-235-236-237-238-239-240-241-242-243-244-245-246-247-248-249-250-251-252-253-254-255-256-257-258-259-260-261-262-263-264-265-266-267-268-269-270-271-272-273-274-275-276-277-278-279-280-281-282-283-284-285-286-287-288-289-290-291-292-293-294-295-296-297-298-299-300-301-302-303-304-305-306-307-308-309-310-311-312-313-314-315-316-317-318-319-320-321-322-323-324-325-326-327-328-329-330-331-332-333-334-335-336-337-338-339-340-341-342-343-344-345-346-347-348-349-350-351-352-353-354-355-356-357-358-359-360-361-362-363-364-365-366-367-368-369-370-371-372-373-374-375-376-377-378-379-380-381-382-383-384-385-386-387-388-389-390-391-392-393-394-395-396-397-398-399-400-401-402-403-404-405-406-407-408-409-410-411-412-413-414-415-416-417-418-419-420-421-422-423-424-425-426-427-428-429-430-431-432-433-434-435-436-437-438-439-440-441-442-443-444-445-446-447-448-449-450-451-452-453-454-455-456-457-458-459-460-461-462-463-464-465-466-467-468-469-470-471-472-473-474-475-476-477-478-479-480-481-482-483-484-485-486-487-488-489-490-491-492-493-494-495-496-497-498-499-500-501-502-503-504-505-506-507-508-509-510-511-512-513-514-515-516-517-518-519-520-521-522-523-524-525-526-527-528-529-530-531-532-533-534-535-536-537-538-539-540-541-542-543-544-545-546-547-548-549-550-551-552-553-554-555-556-557-558-559-560-561-562-563-564-565-566-567-568-569-570-571-572-573-574-575-576-577-578-579-580-581-582-583-584-585-586-587-588-589-590-591-592-593-594-595-596-597-598-599-600-601-602-603-604-605-606-607-608-609-610-611-612-613-614-615-616-617-618-619-620-621-622-623-624-625-626-627-628-629-630-631-632-633-634-635-636-637-638-639-640-641-642-643-644-645-646-647-648-649-650-651-652-653-654-655-656-657-658-659-660-661-662-663-664-665-666-667-668-669-670-671-672-673-674-675-676-677-678-679-680-681-682-683-684-685-686-687-688-689-690-691-692-693-694-695-696-697-698-699-700-701-702-703-704-705-706-707-708-709-710-711-712-713-714-715-716-717-718-719-720-721-722-723-724-725-726-727-728-729-730-731-732-733-734-735-736-737-738-739-740-741-742-743-744-745-746-747-748-749-750-751-752-753-754-755-756-757-758-759-760-761-762-763-764-765-766-767-768-769-770-771-772-773-774-775-776-777-778-779-780-781-782-783-784-785-786-787-788-789-790-791-792-793-794-795-796-797-798-799-800-801-802-803-804-805-806-807-808-809-810-811-812-813-814-815-816-817-818-819-820-821-822-823-824-825-826-827-828-829-830-831-832-833-834-835-836-837-838-839-840-841-842-843-844-845-846-847-848-849-850-851-852-853-854-855-856-857-858-859-860-861-862-863-864-865-866-867-868-869-870-871-872-873-874-875-876-877-878-879-880-881-882-883-884-885-886-887-888-889-890-891-892-893-894-895-896-897-898-899-900-901-902-903-904-905-906-907-908-909-910-911-912-913-914-915-916-917-918-919-920-921-922-923-924-925-926-927-928-929-930-931-932-933-934-935-936-937-938-939-940-941-942-943-944-945-946-947-948-949-950-951-952-953-954-955-956-957-958-959-960-961-962-963-964-965-966-967-968-969-970-971-972-973-974-975-976-977-978-979-980-981-982-983-984-985-986-987-988-989-990-991-992-993-994-995-996-997-998-999-1000

LPG/CNG

**SEAT  
TOLEDO 3**

Toledo 3 1.9 TDI	5P2	1.9	77	09.04 - 02.06	BKC	4	☑	Y-607AS	7560	50	
Toledo 3 1.9 TDI	5P2	1.9	77	10.05 - 05.09	BLS	4	☑	CZ104	9826	52	
Toledo 3 1.9 TDI	5P2	1.9	77	02.06 - 05.09	BXE	4	☑	Y-607AS	7560	50	
Toledo 3 2.0 FSI	5P2	2.0	110	09.04 - 11.05	BLR	4		PZFR5N-11T	7742		PZFR5N-11T
Toledo 3 2.0 FSI	5P2	2.0	110	11.04 - 11.05	BLY	4	0,9	BKR6E	6962	28	LPG 1
Toledo 3 2.0 FSI	5P2	2.0	110	11.05 - 03.09	BVY	4		PZFR5N-11T	7742		PZFR5N-11T
Toledo 3 2.0 FSI	5P2	2.0	110	11.05 - 03.09	BVZ	4	0,9	BKR6E	6962	28	LPG 1
Toledo 3 2.0 TDI	5P2	2.0	100	09.04 - 05.09	AZV	4	☑	YE14	7768	48	
Toledo 3 2.0 TDI	5P2	2.0	103	11.05 - 05.09	BMM	4	☑	Y-607AS	7560	50	
Toledo 3 2.0 TDI	5P2	2.0	125	01.06 - 05.09	BMN	4	☑	CZ304	9864	55	
Toledo 3 2.0 TDI	5P2	2.0	125	03.09 - 05.09	CEGA	4	☑	Y-609AS	5849	49	
Toledo 3 2.0 TDI 16V	5P2	2.0	103	04.04 - 05.09	BKD	4	☑	YE14	7768	48	
Toledo 3 2.0 TFSI	5P2	2.0	147	11.05 - 05.09	BWA	4	0,8	PFR7S8EG	1675		PFR8S8EG

**TOLEDO 4**

Toledo 4 1.2	KG3	1.2	55	10.12 -	CGPC	3	0,9	ZFR6T-11G	5960		ZFR6T-11G
Toledo 4 1.2 TSI	KG3	1.2	63	10.12 -	CBZA	4	0,7	IZFR6P7	97153		IZFR6P7
Toledo 4 1.2 TSI	KG3	1.2	77	10.12 -	CBZB	4	0,7	IZFR6P7	97153		IZFR6P7
Toledo 4 1.4 TSI	KG3	1.4	90	10.12 -	CAXA	4	0,9	PZFR6R	5758		PZFR6R
Toledo 4 1.6 TDI	KG3	1.6	77	10.12 -	CAYC	4	☑	Y1002AS	8888	57	
Toledo 4 1.6 TDI	KG3	1.6	77	10.12 -	CLNA	4	☑	Y1002AS	8888	57	

**SKODA****FAVORIT / FORMAN**

135 LE / LSE		1.3		08.89 - 08.92		4	0,8	BKR6ES	3783	28	LPG 1
135 LX / GLX		1.3		01.93 - 96		4	0,8	BKR6ES	3783	28	LPG 1
135 Favorit L / LS		1.3		04.88 - 95		4	0,8	BCPR5ES	6130	32	LPG 3
135 Favorit LE / LSE		1.3		08.89 - 95		4	0,8	BKR6ES	3783	28	LPG 1
135 Favorit LX / GLX		1.3		01.93 - 95		4	0,8	BKR6ES	3783	28	LPG 1
135 Forman L / LS		1.3		08.90 - 95		4	0,8	BCPR5ES	6130	32	LPG 3
135 Forman LE / LSE		1.3		02.91 - 95		4	0,8	BKR6ES	3783	28	LPG 1
135 Forman LX / GLX		1.3		01.93 - 95		4	0,8	BKR6ES	3783	28	LPG 1
136 Favorit				90 - 92		4	0,8	BCPR6E	1269	12	LPG 3
136 Favorit				93 - 95	mit Catalysator	4		BCPR6ET	2197		LPG 3
136 Favorit				93 - 95		4	0,9	BKR6E	6962	28	LPG 1

**FABIA 1**

Fabia 1 1.0	6Y2	1.0	37	10.00 - 08.02	AQV	4		BKR6ETA-10	7998		
Fabia 1 1.0	6Y2	1.0	37	10.00 - 08.02	ARV	4		BKR6ETA-10	7998		
Fabia 1 1.2	6Y2 / 6Y5	1.2	40	07.01 - 05.04	AWY	3	0,9	ZFR5P-G	6893		LPG 6
Fabia 1 1.2 Fgst —> 6Y-8B451106*	6Y2 / 6Y5	1.2	40	05.04 - 12.07	BMD	3	0,9	ZFR5P-G	6893		LPG 6
Fgst —> 6Y-84035536*											
Fabia 1 1.2 Fgst 6Y-8B451107—>*	6Y2 / 6Y5	1.2	40	05.04 - 12.07	BMD	3	1,1	ZFR6T-11G	5960		ZFR6T-11G
Fgst 6Y-84035537—>*											
Fabia 1 1.2 Fgst —> 6Y-8B451106*	6Y2 / 6Y5	1.2	47	11.04 - 12.07	BME	3	0,9	ZFR5P-G	6893		LPG 6
Fgst —> 6Y-84035536*											
Fabia 1 1.2 Fgst 6Y-8B451107—>*	6Y2 / 6Y5	1.2	47	11.04 - 12.07	BME	3	1,1	ZFR6T-11G	5960		ZFR6T-11G
Fgst 6Y-84035537—>*											
Fabia 1 1.2	6Y2 / 6Y5	1.2	47	01.03 - 12.04	AZQ	3	0,9	ZFR5P-G	6893		LPG 6
Fabia 1 1.4	6Y2 / 6Y5	1.4	44	04.00 - 03.03	AZE	4	0,8	PFR6Q	6458	37	LPG 1
Fabia 1 1.4	6Y2 / 6Y5	1.4	44	04.00 - 03.03	AZF	4	0,8	PFR6Q	6458	37	LPG 1
Fabia 1 1.4	6Y2 / 6Y5	1.4	50	08.99 - 05.03	AME	4		BKUR5ET-10	7553		LPG 1

Fgst = Chassis No.

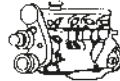
Code *l* kW

Cyl.

Stock-No.  
**VEFINE**  
BY-PROMOTER

LPG/CNG

**SKODA****FABIA 1**

Fabia 1 1.4	6Y2 / 6Y5	1.4	50	08.99 - 01.01	ATZ	4		BKUR5ET-10	7553		LPG 1
Fabia 1 1.4	6Y2 / 6Y5	1.4	50	08.00 - 05.03	AQW	4		BKUR5ET-10	7553		LPG 1
Fabia 1 1.4 16V	6Y2 / 6Y5	1.4	55	10.99 - 08.03	AUA	4		BKUR6ET-10	2397	24	LPG 1
Fabia 1 1.4 16V Automatic	6Y2 / 6Y5	1.4	55	10.99 - 08.03	AUA	4	1,1	PZFR5D-11	7968	34	LPG 6
Fabia 1 1.4 16V Automatic	6Y2 / 6Y5	1.4	55	04.02 - 05.04	BBY	4	1,1	PZFR5D-11	7968	34	LPG 6
Fabia 1 1.4 16V Schaltgetriebe	6Y2 / 6Y5	1.4	55	04.02 - 05.04	BBY	4		BKUR6ET-10	2397	24	LPG 1
Fabia 1 1.4 TDI	6Y2 / 6Y5	1.4	55	04.03 - 10.05	AMF	3	☑	Y-741U	6943	20	
Fabia 1 1.4 16V	6Y2 / 6Y5	1.4	55	05.04 - 12.07	BKY	4	0,9	ZFR5P-G	6893		LPG 6
Fabia 1 1.4	6Y2 / 6Y5	1.4	59	05.06 - 12.07	BUD	4	1,1	ZFR6T-11G	5960		ZFR6T-11G
Fabia 1 1.4 16V	6Y2 / 6Y5	1.4	74	10.99 - 08.03	AUB	4		BKUR6ET-10	2397	24	LPG 1
Fabia 1 1.4 16V	6Y2 / 6Y5	1.4	74	05.02 - 12.07	BBZ	4		BKUR6ET-10	2397	24	LPG 1
Fabia 1 1.9 SDI	6Y2 / 6Y5	1.9	47	11.99 - 03.08	ASY	4	☑	Y-732J	5605	4	
Fabia 1 1.9 TDI	6Y2 / 6Y5	1.9	74	01.00 - 10.05	ATD →6Y-2-451087	4	☑	Y-732J	5605	4	
Fabia 1 1.9 TDI	6Y2 / 6Y5	1.9	74	01.00 - 10.05	ATD 6Y-2-451088 →	4	☑	Y-741U	6943	20	
Fabia 1 1.9 TDI	6Y2 / 6Y5	1.9	74	10.05 - 12.07	AXR	4	☑	Y-741U	6943	20	
Fabia 1 1.9 TDI RS	6Y2 / 6Y5	1.9	96	06.03 - 10.05	ASZ	4	☑	Y-741U	6943	20	
Fabia 1 1.9 TDI RS	6Y2 / 6Y5	1.9	96	10.05 - 04.07	BLT	4	☑	Y-741U	6943	20	
Fabia 1 2.0	6Y2 / 6Y5	2.0	85	12.99 - 12.07	AZL	4		BKUR6ET-10	2397	24	LPG 1

**FABIA 2**

Fabia 2 1.2	542 / 545	1.2	44	12.06 - 03.09	BBM	3	0,9	ZFR5P-G	6893		LPG 6
Fabia 2 1.2	542 / 545	1.2	44	03.09 - 11.11	CHFA	3	1,1	ZFR6T-11G	5960		ZFR6T-11G
Fabia 2 1.2	542 / 545	1.2	44	11.11 -	CGPB	3	1,1	ZFR6T-11G	5960		ZFR6T-11G
Fabia 2 1.2	542 / 545	1.2	51	03.09 - 03.10	CGPA	3	1,1	ZFR6T-11G	5960		ZFR6T-11G
Fabia 2 1.2 Fgst → 5J-8B501225* Fgst → 5J-83074394*	542 / 545	1.2	52	01.07 - 05.09	BZG	3	0,9	ZFR5P-G	6893		LPG 6
Fabia 2 1.2 Fgst 5J-8B501226 →* Fgst 5J-83074395 →*	542 / 545	1.2	52	01.07 - 05.09	BZG	3	1,1	ZFR6T-11G	5960		ZFR6T-11G
Fabia 2 1.2 Fgst 5J-8B501226 →* Fgst 5J-83074395 →*	542 / 545	1.2	52	01.08 - 09.10	CEVA	3	1,1	ZFR6T-11G	5960		ZFR6T-11G
Fabia 2 1.2 TDI	542 / 545	1.2	55	03.10 -	CFWA	3	☑	Y1002AS	8888	57	
Fabia 2 1.2 TSI	542 / 545	1.2	63	03.10 -	CBZA	4	0,7	IZFR6P7	97153		IZFR6P7
Fabia 2 1.2 TSI	542 / 545	1.2	77	03.10 -	CBZB	4	0,7	IZFR6P7	97153		IZFR6P7
Fabia 2 1.4 TDI	542 / 545	1.4	51	10.05 - 03.10	BNM	3	☑	Y-741U	6943	20	
Fabia 2 1.4 TDI	542 / 545	1.4	59	10.05 - 03.10	BNV	3	☑	Y-741U	6943	20	
Fabia 2 1.4 TDI	542 / 545	1.4	59	01.07 - 03.10	BMS	3	☑	CZ104	9826	52	
Fabia 2 1.4	542 / 545	1.4	63	03.10 -	CGGB	4	1,1	ZFR6T-11G	5960		ZFR6T-11G
Fabia 2 1.4	542 / 545	1.4	63	01.07 - 03.10	BXW	4	1,1	ZFR6T-11G	5960		ZFR6T-11G
Fabia 2 1.4 TSI RS	542 / 545	1.4	132	05.10 - 02.11	CAVE	4	0,8	PZFR6R8EG	96498		PZFR6R8EG
Fabia 2 1.4 TSI RS	542 / 545	1.4	132	05.10 -	CTHE	4	0,8	PZFR6R8EG	96498		PZFR6R8EG
Fabia 2 1.6 TDI	542 / 545	1.6	55	04.10 -	CAYA	4	☑	Y1002AS	8888	57	
Fabia 2 1.6 TDI	542 / 545	1.6	66	03.10 -	CAYB	4	☑	Y1002AS	8888	57	
Fabia 2 1.6	542 / 545	1.6	77	04.07 -	BTS	4	1,1	ZFR6T-11G	5960		ZFR6T-11G
Fabia 2 1.6	542 / 545	1.6	77	06.10 -	CFNA	4	1,1	ZFR6T-11G	5960		ZFR6T-11G
Fabia 2 1.6 TDI	542 / 545	1.6	77	03.10 -	CAYC	4	☑	Y1002AS	8888	57	
Fabia 2 1.9 TDI	542 / 545	1.9	77	04.07 - 03.10	BLS	4	☑	CZ104	9826	52	
Fabia 2 1.9 TDI	542 / 545	1.9	77	04.07 - 03.10	BSW	4	☑	Y-741U	6943	20	

**FELICIA**

Felicia		1.0	37	08.99 -	AHT	4		BKR6ETA-10	7998		
Felicia 135i		1.3	40	10.94 - 07.96	MPI	4		BKUR5ET-10	7553		LPG 1
Felicia		1.3	40	08.96 - 08.01	AMG	4		BKUR5ET-10	7553		LPG 1

Fgst = Chassis No.

Code *ℓ* kW

Cyl.



Stock-No.



LPG/CNG

**SKODA FELICIA**

Felicia		1.3	43	10.94 - 07.96		4	0,8	BCPR5ES	6130	32	LPG 3
Felicia 135i		1.3	43	08.96 -	AMJ	4	0,8	BCPR5ES	6130	32	LPG 3
Felicia 136i		1.3	50	10.94 - 07.96	136B	4	0,8	BCPR6ES	2330	12	LPG 3
Felicia 136i		1.3	50	10.94 - 07.96	136M	4	0,8	BKR6ES	3783	28	LPG 1
Felicia		1.3	50	08.96 - 08.01	AMH	4		BKUR5ET-10	7553		LPG 1
Felicia		1.4	74	99 -		4		BKUR6ET-10	2397	24	LPG 1
Felicia		1.6	55	05.95 - 08.01	AEE	4		BUR6ET	3172	1	LPG 2
Felicia D		1.9	47	10.95 - 08.01	AEF	4	☑	Y-918J	6285	2	
Felicia D		1.9	47	97 -	AEY	4	☑	Y-732J	5605	4	

**OCTAVIA 1**

Octavia 1 1.4	1U2 / 1U5	1.4	44	02.99 - 03.01	AMD	4		BKUR6ET-10	2397	24	LPG 1
Octavia 1 1.4 16V	1U2 / 1U5	1.4	55	01.02 - 12.10	BCA	4		BKUR6ET-10	2397	24	LPG 1
Octavia 1 1.4 16V Automatik	1U2 / 1U5	1.4	55	08.00 - 01.02	AXP	4	1,1	PZFR5D-11	7968	34	LPG 6
Octavia 1 1.4 16V Schaltgetriebe	1U2 / 1U5	1.4	55	08.00 - 01.02	AXP	4		BKUR6ET-10	2397	24	LPG 1
Octavia 1 1.6	1U2 / 1U5	1.6	55	10.96 - 09.04	AEE	4		BUR6ET	3172	1	LPG 2
Octavia 1 1.6	1U2 / 1U5	1.6	74	02.97 - 12.07	AEH	4		BKUR6ET-10	2397	24	LPG 1
Octavia 1 1.6	1U2 / 1U5	1.6	74	08.98 - 12.07	AKL	4		BKUR6ET-10	2397	24	LPG 1
Octavia 1 1.6	1U2 / 1U5	1.6	75	08.00 - 04.02	AVU	4		BKUR6ET-10	2397	24	LPG 1
Octavia 1 1.6	1U2 / 1U5	1.6	75	04.02 - 12.10	BFQ	4		BKUR6ET-10	2397	24	LPG 1
Octavia 1 1.8 20V	1U2 / 1U5	1.8	92	10.96 - 07.00	AGN	4		BKUR6ET-10	2397	24	LPG 1
Octavia 1 1.8 T	1U2 / 1U5	1.8	110	05.98 - 12.10	AGU	4	0,8	PFR6Q	6458	37	LPG 1
Octavia 1 1.8 T	1U2 / 1U5	1.8	110	08.00 - 05.06	ARX	4	0,8	PFR6Q	6458	37	LPG 1
Octavia 1 1.8 T	1U2 / 1U5	1.8	110	01.00 - 07.00	ARZ	4	0,8	PFR6Q	6458	37	LPG 1
Octavia 1 1.8 T	1U2 / 1U5	1.8	110	08.00 - 12.10	AUM	4	0,8	PFR6Q	6458	37	LPG 1
Octavia 1 1.8 T RS	1U2 / 1U5	1.8	132	12.00 - 01.06	AUQ	4	0,8	PFR6Q	6458	37	LPG 1
Octavia 1 1.9 SDI	1U2 / 1U5	1.9	50	05.97 - 12.03	AGP	4	☑	Y-732J	5605	4	
Octavia 1 1.9 SDI	1U2 / 1U5	1.9	50	08.00 - 12.03	AQM	4	☑	Y-732J	5605	4	
Octavia 1 1.9 TDI	1U2 / 1U5	1.9	66	10.96 - 03.10	AGR	4	☑	Y-732J	5605	4	
Octavia 1 1.9 TDI	1U2 / 1U5	1.9	66	08.00 - 03.10	ALH	4	☑	Y-732J	5605	4	
Octavia 1 1.9 TDI	1U2 / 1U5	1.9	81	08.97 - 01.06	AHF	4	☑	Y-732J	5605	4	
Octavia 1 1.9 TDI	1U2 / 1U5	1.9	81	10.00 - 01.06	ASV	4	☑	Y-732J	5605	4	
Octavia 1 1.9 TDI	1U2 / 1U5	1.9	96	09.02 - 09.04	ASZ	4	☑	Y-741U	6943	20	
Octavia 1 1.9 TDI 4x4	1U5	1.9	74	08.00 - 01.06	ATD	4	☑	Y-732J	5605	4	
Octavia 1 1.9 TDI Fgst → 1U-22598796 Fgst → 1U-28558122	1U2 / 1U5	1.9	74	10.05 - 12.10	AXR	4	☑	Y-732J	5605	4	
Octavia 1 1.9 TDI Fgst 1U-22598797→ Fgst 1U-28558123→	1U2 / 1U5	1.9	74	10.05 - 12.10	AXR	4	☑	Y-741U	6943	20	
Octavia 1 2.0	1U2 / 1U5	2.0	85	05.99 - 05.07	APK	4		BKUR6ET-10	2397	24	LPG 1
Octavia 1 2.0	1U2 / 1U5	2.0	85	05.99 - 03.02	AQY	4		BKUR6ET-10	2397	24	LPG 1
Octavia 1 2.0	1U2 / 1U5	2.0	85	11.99 - 09.04	AZH	4		BKUR6ET-10	2397	24	LPG 1
Octavia 1 2.0	1U2 / 1U5	2.0	85	09.00 - 01.05	AEG	4		BKUR6ET-10	2397	24	LPG 1
Octavia 1 2.0 4x4	1U5	2.0	85	03.02 - 01.06	AZJ	4	1,1	PZFR5D-11	7968	34	LPG 6
Octavia 1 2.0 4x4	1U5	2.0	88	11.99 - 04.01	ATF	4	1,1	PZFR5D-11	7968	34	LPG 6

**OCTAVIA 2**

Octavia 2 1.2 TSI	1Z3 / 1Z5	1.2	77	02.10 -	CBZB	4	0,7	IZFR6P7	97153		IZFR6P7
Octavia 2 1.4	1Z3 / 1Z5	1.4	55	05.04 - 05.06	BCA	4		BKUR6ET-10	2397	24	LPG 1
Octavia 2 1.4	1Z3 / 1Z5	1.4	59	05.06 -	BUD	4	1,1	ZFR6T-11G	5960		ZFR6T-11G
Octavia 2 1.4 TSI	1Z3 / 1Z5	1.4	90	11.08 -	CAXA	4	0,9	PZFR6R	5758		PZFR6R
Octavia 2 1.6	1Z3 / 1Z5	1.6	75	05.04 - 05.05	BGU	4		BKUR6ET-10	2397	24	LPG 1
Octavia 2 1.6	1Z3 / 1Z5	1.6	75	05.05 -	BSE	4		BKUR6ET-10	2397	24	LPG 1
Octavia 2 1.6	1Z3 / 1Z5	1.6	75	05.05 -	BSF	4		BKUR6ET-10	2397	24	LPG 1

Fgst = Chassis No.

Code *l* kW

Cyl.



Stock-No.

LPG/CNG

**SKODA****OCTAVIA 2**

Octavia 2 1.6	1Z3 / 1Z5	1.6	75	11.07 - 05.10	CCSA	4		BKUR6ET-10	2397	24	LPG 1
Octavia 2 1.6	1Z3 / 1Z5	1.6	75	05.10 -	CMXA	4		BKUR6ET-10	2397	24	LPG 1
Octavia 2 1.6 FSI	1Z3 / 1Z5	1.6	85	02.04 - 10.08	BLF	4		ZFR6S-Q	6449		ZFR6S-Q
Octavia 2 1.6 LPG	1Z3 / 1Z5	1.6	75	08.09 -	CHGA	4		BKUR6ET-10	2397	24	LPG 1
Octavia 2 1.6 TDI	1Z3 / 1Z5	1.6	77	06.09 -	CAYC	4	☑	Y1002AS	8888	57	
Octavia 2 1.8 TSI	1Z3 / 1Z5	1.8	118	06.07 - 10.08	BZB	4	0,8	PFR7S8EG	1675		PFR8S8EG
Octavia 2 1.8 TSI	1Z3 / 1Z5	1.8	118	11.08 -	CDAA	4	0,8	PFR7S8EG	1675		PFR8S8EG
Octavia 2 1.9 TDI	1Z3 / 1Z5	1.9	77	05.04 - 12.10	BJB	4	☑	Y-607AS	7560	50	
Octavia 2 1.9 TDI	1Z3 / 1Z5	1.9	77	05.04 - 02.06	BKC	4	☑	Y-607AS	7560	50	
Octavia 2 1.9 TDI	1Z3 / 1Z5	1.9	77	05.06 - 12.10	BLS	4	☑	Y-607AS	7560	50	
Octavia 2 1.9 TDI	1Z3 / 1Z5	1.9	77	03.06 - 12.10	BXE	4	☑	Y-607AS	7560	50	
Octavia 2 2.0 TDI	1Z3 / 1Z5	2.0	81	03.10 - 06.13	CFHF	4	☑	Y1002AS	8888	57	
Octavia 2 2.0 TDI	1Z3 / 1Z5	2.0	81	03.10 - 06.13	CLCA	4	☑	Y1002AS	8888	57	
Octavia 2 2.0 TDI	1Z3 / 1Z5	2.0	100	05.04 - 10.08	AZV	4	☑	YE14	7768	48	
Octavia 2 2.0 TDI 16V	1Z3 / 1Z5	2.0	100	05.04 -	BKD	4	☑	YE14	7768	48	
Octavia 2 2.0 TDI	1Z3 / 1Z5	2.0	103	11.05 - 05.10	BMM	4	☑	Y-607AS	7560	50	
Octavia 2 2.0 TDI 16V	1Z3 / 1Z5	2.0	103	03.10 -	CFHC	4	☑	Y1002AS	8888	57	
Octavia 2 2.0 TDI 16V	1Z3 / 1Z5	2.0	103	02.10 -	CLCB	4	☑	Y1002AS	8888	57	
Octavia 2 2.0 FSI	1Z3 / 1Z5	2.0	110	11.04 - 11.05	BLR	4		PZFR5N-11T	7742		PZFR5N-11T
Octavia 2 2.0 FSI	1Z3 / 1Z5	2.0	110	11.04 - 11.05	BLY	4	0,9	BKR6E	6962	28	LPG 1
Octavia 2 2.0 FSI	1Z3 / 1Z5	2.0	110	11.05 - 10.08	BVY	4		PZFR5N-11T	7742		PZFR5N-11T
Octavia 2 2.0 FSI	1Z3 / 1Z5	2.0	110	11.05 - 10.08	BVZ	4	0,9	BKR6E	6962	28	LPG 1
Octavia 2 2.0 FSI 4x4	1Z5	2.0	110	11.04 - 11.05	BLX	4		PZFR5N-11T	7742		PZFR5N-11T
Octavia 2 2.0 FSI 4x4	1Z5	2.0	110	11.05 - 10.08	BVX	4		PZFR5N-11T	7742		PZFR5N-11T
Octavia 2 2.0 TDI RS	1Z3 / 1Z5	2.0	125	04.06 - 05.08	BMN	4	☑	CZ304	9864	55	
Octavia 2 2.0 TDI RS	1Z3 / 1Z5	2.0	125	06.08 -	BMN	4	☑	Y1002AS	8888	57	
Octavia 2 2.0 TDI RS	1Z3 / 1Z5	2.0	125	04.06 -	CEGA	4	☑	Y1002AS	8888	57	
Octavia 2 2.0 TSI RS	1Z3 / 1Z5	2.0	147	10.05 - 10.08	BWA	4	0,8	PFR7S8EG	1675		PFR8S8EG
Octavia 2 2.0 TSI RS	1Z3 / 1Z5	2.0	147	11.08 -	CCZA	4	0,8	PFR7S8EG	1675		PFR8S8EG

**OCTAVIA 3**

Octavia 3 1.6 TDI	5E3/5E5	1.6	77	11.12 -	CLHA	4	☑	Y1002AS	8888	57	
für Fzg. ohne Drucksensor											
Octavia 3 2.0 TDI	5E3/5E5	2.0	110	11.12 -	CKFC	4	☑	Y1002AS	8888	57	
für Fzg. ohne Drucksensor											

**PICKUP**

Pickup 135 L		1.3		06.90 - 96	u.Cat.	4	0,8	BCPR5ES	6130	32	LPG 3
Pickup 135 LE		1.3		10.91 - 96		4	0,8	BKR6ES	3783	28	LPG 1
Pickup 135 LX		1.3		01.93 - 96		4	0,8	BKR6ES	3783	28	LPG 1
Pickup		1.9	47	97 -	AEY	4	☑	Y-732J	5605	4	
Pick-up 135i		1.3	40	96 -	135M	4		BKUR5ET-10	7553		LPG 1
Pick-up 136i		1.3	50	96 -	136M	4		BKUR5ET-10	7553		LPG 1

**RAPID**

Rapid 1.2	NH3	1.2	55	07.12 -	CGPC	3	1,1	ZFR6T-11G	5960		ZFR6T-11G
Rapid 1.2 TSI	NH3	1.2	63	07.12 -	CBZA	4	0,7	IZFR6P7	97153		IZFR6P7
Rapid 1.2 TSI	NH3	1.2	77	07.12 -	CBZB	4	0,7	IZFR6P7	97153		IZFR6P7
Rapid 1.4 TSI	NH3	1.4	90	07.12 -	CAXA	4	0,9	PZFR6R	5758		PZFR6R
Rapid 1.6 TDI	NH3	1.6	77	07.12 -	CAYC	4	☑	Y1002AS	8888	57	

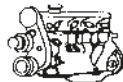

Code *l* kW

Cyl.



Stock-No.



LPG/CNG

**SKODA ROOMSTER**

Roomster 1.2 Fgst → 5J-8B600480* Fgst → 5J-85036340*	5J	1.2	47	05.06 - 01.07	BME	3	0,9	ZFR5P-G	6893		LPG 6
Roomster 1.2 Fgst 5J-8B600481 →>* Fgst 5J-85036341 →*	5J	1.2	47	05.06 - 01.07	BME	3	1,1	ZFR6T-11G	5960		ZFR6T-11G
Roomster 1.2	5J	1.2	51	03.09 -	CGPA	3	1,1	ZFR6T-11G	5960		ZFR6T-11G
Roomster 1.2 Fgst → 5J-8B600480* Fgst → 5J-85036340*	5J	1.2	52	01.07 - 03.09	BZG	3	0,9	ZFR5P-G	6893		LPG 6
Roomster 1.2 Fgst 5J-8B600481 →>* Fgst 5J-85036341 →*	5J	1.2	52	01.07 - 03.09	BZG	3	1,1	ZFR6T-11G	5960		ZFR6T-11G
Roomster 1.2 TDI	5J	1.2	55	03.10 -	CFWA	3	█	Y1002AS	8888	57	
Roomster 1.2 TSI	5J	1.2	63	03.10 -	CBZA	4	0,7	IZFR6P7	97153		IZFR6P7
Roomster 1.2 TSI	5J	1.2	77	03.10 -	CBZB	4	0,7	IZFR6P7	97153		IZFR6P7
Roomster 1.4 TDI	5J	1.4	51	07.06 -	BNM	3	█	Y-741U	6943	20	
Roomster 1.4 TDI	5J	1.4	59	07.06 -	BMS	3	█	CZ104	9826	52	
Roomster 1.4 TDI	5J	1.4	59	05.06 -	BNV	3	█	Y-741U	6943	20	
Roomster 1.4	5J	1.4	63	05.06 -	BXW	4	1,1	ZFR6T-11G	5960		ZFR6T-11G
Roomster 1.4	5J	1.4	63	03.10 -	CGGB	4	1,1	ZFR6T-11G	5960		ZFR6T-11G
Roomster 1.6 TDI	5J	1.6	66	03.10 -	CAYB	4	█	Y1002AS	8888	57	
Roomster 1.6	5J	1.6	77	05.06 -	BTS	4	1,1	ZFR6T-11G	5960		ZFR6T-11G
Roomster 1.6	5J	1.6	77	06.10 -	CFNA	4	1,1	ZFR6T-11G	5960		ZFR6T-11G
Roomster 1.6 TDI	5J	1.6	77	03.10 -	CAYC	4	█	Y1002AS	8888	57	
Roomster 1.9 TDI	5J	1.9	74	03.06 - 05.06	AXR	4	█	Y-741U	6943	20	
Roomster 1.9 TDI	5J	1.9	77	11.06 -	BLS	4	█	CZ104	9826	52	
Roomster 1.9 TDI	5J	1.9	77	05.06 -	BSW	4	█	Y-741U	6943	20	

**SUPERB 1**

Superb 1 1.8 Turbo	3U4	1.8	110	10.01 - 03.08	AWT	4	0,8	PFR6Q	6458	37	LPG 1
Superb 1 1.9 TDI	3U4	1.9	74	06.02 - 10.05	AVB	4	█	Y-741U	6943	20	
Superb 1 1.9 TDI	3U4	1.9	77	10.05 - 05.07	BSV	4	█	CZ104	9826	52	
Superb 1 1.9 TDI	3U4	1.9	85	01.07 - 03.08	BPZ	4	█	CZ104	9826	52	
Superb 1 1.9 TDI	3U4	1.9	96	10.01 - 03.08	AWX	4	█	Y-741U	6943	20	
Superb 1 1.9 TDI	3U4	1.9	96	01.04 - 03.08	AVF	4	█	Y-741U	6943	20	
Superb 1 2.0	3U4	2.0	85	12.01 - 03.08	AZM	4		BKUR6ET-10	2397	24	LPG 1
Superb 1 2.0 TDI	3U4	2.0	103	10.05 - 03.08	BSS	4	█	CZ104	9826	52	
Superb 1 2.5 V6 TDI	3U4	2.5	114	12.01 - 08.03	AYM	6	█	Y-501U	3786	31	
Superb 1 2.5 V6 TDI	3U4	2.5	120	06.03 - 03.08	BDG	6	█	Y-501U	3786	31	
Superb 1 2.8 V6	3U4	2.8	140	05.02 - 03.08	BBG	6		BKR6EKUB	3584		LPG 1
Superb 1 2.8 V6	3U4	2.8	142	12.01 - 03.08	AMX	6		BKR6EKUB	3584		LPG 1

**SUPERB 2**

Superb 2 1.4 TSI	3T4 / 3T5	1.4	92	08.08 -	CAXC	4	0,9	PZFR6R	5758		PZFR6R
Superb 2 1.6 TDI	3T4 / 3T5	1.6	77	09.10 -	CAYC	4	█	Y1002AS	8888	57	
Superb 2 1.8 TSI	3T4 / 3T5	1.8	118	03.08 - 05.09	BZB	4	0,8	PFR7S8EG	1675		PFR8S8EG
Superb 2 1.8 TSI	3T4 / 3T5	1.8	118	09.08 -	CDA A	4	0,8	PFR7S8EG	1675		PFR8S8EG
Superb 2 1.9 TDI	3T4 / 3T5	1.9	77	07.08 -	BLS	4	█	Y-607AS	7560	50	
Superb 2 1.9 TDI	3T4 / 3T5	1.9	77	03.08 -	BXE	4	█	Y-607AS	7560	50	
Superb 2 2.0 TDI	3T4 / 3T5	2.0	100	01.09 -	BKD	4	█	YE14	7768	48	
Superb 2 2.0 TDI	3T4 / 3T5	2.0	103	03.08 - 03.10	BMP	4	█	CZ104	9826	52	
Superb 2 2.0 TDI	3T4 / 3T5	2.0	103	03.10 -	CFFB	4	█	Y1002AS	8888	57	
Superb 2 2.0 TDI	3T4 / 3T5	2.0	103	02.10 -	CLJA	4	█	Y1002AS	8888	57	
Superb 2 2.0 TDI	3T4 / 3T5	2.0	125	06.08 - 05.10	CBBB	4	█	Y1002AS	8888	57	

Fgst = Chassis No.

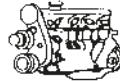
Code *l* kW

Cyl.



Stock-No.

VEMO  
E-POWER  
LPG/CNG**SKODA****SUPERB 2**

Superb 2 2.0 TDI	3T4 / 3T5	2.0	125	05.10 -	CFGB	4	█	Y1002AS	8888	57	
Superb 2 2.0 TSI	3T4 / 3T5	2.0	147	05.10 -	CCZA	4	0,8	PFR7S8EG	1675		PFR8S8EG
Superb 2 3.6 V6 4x4	3T4 / 3T5	3.6	191	09.08 -	CDVA	6	0,8	ILZKR8A	94290		ILZKR8A

**YETI**

Yeti 1.2 TSI	5L	1.2	77	09.09 -	CBZB	4	0,7	IZFR6P7	97153		IZFR6P7
Yeti 1.4 TSI	5L	1.4	90	06.10 -	CAXA	4	0,9	PZFR6R	5758		PZFR6R
Yeti 1.6 TDI	5L	1.6	77	11.10 -	CAYC	4	█	Y1002AS	8888	57	
Yeti 1.8 TSI 4x4	5L	1.8	112	11.09 -	CDAB	4	0,8	PFR7S8EG	1675		PFR8S8EG
Yeti 1.8 TSI 4x4	5L	1.8	118	05.09 -	CDA A	4	0,8	PFR7S8EG	1675		PFR8S8EG
Yeti 2.0 TDI	5L	2.0	81	11.09 -	CFHA	4	█	Y1002AS	8888	57	
Yeti 2.0 TDI	5L	2.0	81	11.09 -	CFHA	4	█	Y1002AS	8888	57	
Yeti 2.0 TDI	5L	2.0	81	11.09 -	CFHF	4	█	Y1002AS	8888	57	
Yeti 2.0 TDI	5L	2.0	103	05.09 - 11.09	CBDB	4	█	Y1002AS	8888	57	
Yeti 2.0 TDI	5L	2.0	103	11.09 -	CFHC	4	█	Y1002AS	8888	57	
Yeti 2.0 TDI 4x4	5L	2.0	125	11.09 - 05.10	CEGA	4	█	Y1002AS	8888	57	
Yeti 2.0 TDI 4x4	5L	2.0	125	11.09 -	CFJA	4	█	Y1002AS	8888	57	

**SMART****CITY-COUPÉ**

Smart	MC01	0.6	33	10.98 - 01.04	M 160 ... Twin Spark	3		BKR6EKE	5649		
Smart	MC01	0.6	40	10.98 - 01.04	M 160 ... Twin Spark	3		BKR6EKE	5649		
Smart	MC01	0.7	37	10.02 - 01.04	M 160/1 Twin Spark	3		LKR8A	5214		LKR8A
Smart	MC01	0.7	60	10.02 - 01.04	M 160/1 Twin Spark	3		LKR8A	5214		LKR8A
Smart CDI	MC01	0.8	29	07.98 - 01.04	OM 660 DE 08 LA	3	█	Y-543J	5618	46	

**CROSSBLADE**

Smart Crossblade		0.6	52	10.02 - 01.04	M 160 ... Twin Spark	3		BKR6EKE	5649		
------------------	--	-----	----	---------------	----------------------	---	--	---------	------	--	--

**FORTWO 1**

Smart fortwo	450	0.7	37	01.04 -	M 160/1 Twin Spark	3		LKR8A	5214		LKR8A
Smart fortwo	450	0.7	45	01.04 -	M 160/1 Twin Spark	3		LKR8A	5214		LKR8A
Smart fortwo Cdi	450	0.8	30	01.04 -	OM 660	3	█	Y-543J	5618	46	

**FORTWO 2**

Smart fortwo 2	451	1.0	45	03.07 -	M 132.910	3	0,9	LKR7B-9	5847		LKR7B-9
Smart fortwo 2	451	1.0	52	03.07 -	M 132.910	3	0,9	LKR7B-9	5847		LKR7B-9
Smart fortwo 2 Turbo	451	1.0	62	03.07 -	M 132.930	3	0,9	LKR7B-9	5847		LKR7B-9
Smart fortwo Brabus	451	1.0	72	01.08 -	M 132.930	3	0,9	LKR7B-9	5847		LKR7B-9

**ROADSTER / COUPÉ**

Smart Roadster	452	0.7	45	10.02 - 11.05	M 160/1 Twin Spark	3		LKR8A	5214		LKR8A
Smart Roadster	452	0.7	60	06.03 - 11.05	M 160/1 Twin Spark	3		LKR8A	5214		LKR8A
Smart Roadster Brabus	452	0.7	74	12.03 -	M 160/1 Twin Spark	3		LKR8A	5214		LKR8A

**FORFOUR**

Smart forfour	454	1.1	55	01.04 - 06	M 134.910	3	1,1	LFR6C-11	5788		
Smart forfour	454	1.3	70	01.04 - 06	M 135.930	4	1,1	LFR6C-11	5788		
Smart forfour Cdi	454	1.5	50	09.04 -	OM 639.939	3	█	YE13	8643		
Smart forfour Cdi	454	1.5	70	09.04 -	OM 639.939	3	█	YE13	8643		
Smart forfour	454	1.5	80	01.04 - 06	M 135.950	4	1,1	LFR6C-11	5788		
Smart forfour Brabus	454	1.5	130	05.05 -	M 122.950	4	0,8	ILZFR6C-K	6645		ILZFR6C-K

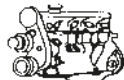
Code *l* kW

Cyl.

Stock-No.  
**VELINE**  
10-11-12-13-14-15-16-17-18-19-20-21-22-23-24-25-26-27-28-29-30-31-32-33-34-35-36-37-38-39-40-41-42-43-44-45-46-47-48-49-50-51-52-53-54-55-56-57-58-59-60-61-62-63-64-65-66-67-68-69-70-71-72-73-74-75-76-77-78-79-80-81-82-83-84-85-86-87-88-89-90-91-92-93-94-95-96-97-98-99-100

LPG/CNG

**SSANGYONG  
ACTYON**

Actyon 200 Xdi		2.0	100	07.07 -	D20DT	4		Y-536J	95061	81	
Actyon Sports 200 Xdi		2.0	104	10.06 -	D20DT	4		Y-536J	95061	81	

**KORANDO**

Korando		2.0	100	07.96 -	M161E20 M111.940	4	0,8	BCP5ES	7496	16	LPG 3
Korando D		2.2	51	01.93 -	DC 23	4		Y-710J	7880		
Korando D		2.3	55	03.97 -	OM 601 DM	4		Y-916J	5906	6	
Korando TD		2.3	73	03.99 - 03.00		4		Y-916J	5906	6	
Korando		2.3	110	09.96 - 02.99	M161E23 M111.970	4	0,8	BCP5ES	7496	16	LPG 3
Korando D		2.9	73	12.96 -	MB-OM 602	5		Y-916J	5906	6	
Korando TD		2.9	88	03.99 - 03.00		5		Y-916J	5906	6	
Korando		3.2	162	09.96 - 03.00	M162E32 M104...	6	0,8	BCP5ES	7496	16	LPG 3
Korando LPG		3.2	162	07.97 - 03.00		6	0,8	BKR5EIX	6341		LPG 1

**KYRON**

Kyron 2.0 Xdi		2.0	100	01.10 -	D20DT	4		Y-536J	95061	81	
Kyron 2.0 Xdi		2.0	104	05.05 -	D20DT	4		Y-536J	95061	81	
Kyron 2.7 Xdi		2.7	120	03.06 -	D27DT	5		Y-536J	95061	81	
Kyron 2.7 Xdi		2.7	121	05.05 -	D27DT	5		Y-536J	95061	81	
Kyron 3.2		3.2	162	03.08 -	G32D	6	0,8	BCP5ES	7496	16	LPG 3

**MUSSO**

Musso		2.0	100	05.96 -	M161E20 M111.940	4	0,8	BCP5ES	7496	16	LPG 3
Musso 601 D		2.3	58	07.93 - 01.00	MB-OM 601	4		Y-916J	5906	6	
Musso TD		2.3	73	03.99 - 03.00		4		Y-916J	5906	6	
Musso		2.3	110	05.96 - 02.99	M161E23 M111.970	4	0,8	BCP5ES	7496	16	LPG 3
Musso 602 D		2.9	73	07.93 - 01.00	MB-OM 602	5		Y-916J	5906	6	
Musso TD		2.9	88	03.99 -		5		Y-916J	5906	6	
Musso Sports 290S TD		2.9	88	03.04 -		5		Y-916J	5906	6	
Musso E32		3.2	162	01.96 -	M162E32 M104...	6	0,8	BCP5ES	7496	16	LPG 3

**REXTON**

Rexton RX 230 4x4		2.3	110	05.02 - 08.06	G23D	4	0,8	BCP5ES	7496	16	LPG 3
Rexton 2.7 Xdi 4x4		2.7	118	03.11 -	D27DT	5		Y-536J	95061	81	
Rexton 2.7 Xdi		2.7	120	07.04 -	D27DT	5		Y-536J	95061	81	
Rexton 2.7 Xdi		2.7	121	03.05 - 08.06		5		Y-537AS	9994		
Rexton 2.7 Xdi Turbo 4x4		2.7	132	03.11 -	D27DTP	5		Y-536J	95061	81	
Rexton 2.7 D 4x4		2.7	137	05.06 -		5		Y-537AS	9994		
Rexton RX 290s		2.9	88			5		Y-916J	5906	6	
Rexton RX 320s		3.2	162	04.02 - 08.06	G32D	6	0,8	BCP5ES	7496	16	LPG 3

**RODIUS**

Rodius 2.7 Xdi		2.7	120	05.05 -	D27DT	5		Y-536J	95061	81	
Rodius 2.7 Xdi		2.7	121	05.05 -	D27DT	5		Y-536J	95061	81	
Rodius 3.2		3.2	162	07.07 -	G32D	6	0,8	BCP5ES	7496	16	LPG 3

**STEYR**

Puch 290 GD		2.9	72	08.93 -	OM602	5		Y-916J	5906	6	
Puch 300 GD		3.0	83	09.89 -	OM617/603	6		Y-916J	5906	6	
Puch 350 GTD		3.5	100	09.91 -	OM617/603	6		Y-916J	5906	6	

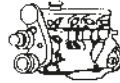
Code *l* kW

Cyl.



Stock-No.

**SUBARU****FORESTER**

Forester		2.0	90	09.97 - 02	EJ20J	4	1,1	BCPR6ES-11	7121	11	LPG 3
Forester		2.0	92	09.97 -	EJ20	4	1,1	BKR6E-11	2756	14	LPG 1
Forester		2.0	110	01.08 -	EJ204	4	1,1	SILFR6A11	5468		SILFR6A11
Forester		2.0	116	09.05 - 02.08	EJ20	4	0,8	ILFR6B	6481		ILFR6B
Forester		2.0	116	03.08 -	EJ20	4	0,8	ILFR6B	6481		ILFR6B
Forester 2.0 Turbo		2.0	130	03.99 - 02	EJ20	4	0,9	PFR6B	3500		PFR7B
Forester 2.5 Turbo		2.5	155	05 -	EJ25	4	0,8	PFR6G	4793		PFR7G
Forester		2.5	169	06 - 02.08	EJ25	4	0,8	ILFR6B	6481		ILFR6B
Forester		2.5	169	06.08 -	EJ255	4	0,8	ILFR6B	6481		ILFR6B

**IMPREZA**

Impreza 1.5R		1.5	79	09.07 -	EJ15	4	0,8	ILFR6B	6481		ILFR6B
Impreza 1,6		1.6	66	93 - 00	EJ16	4	1,1	BKR6E-11	2756	14	LPG 1
Impreza		1.6	70	12.00 - 03	EJ16	4	1,1	BKR6E-11	2756	14	LPG 1
Impreza		1.6	70	03 - 06	EJ16	4	0,8	PFR6G	4793		PFR7G
Impreza 1,8		1.8	76	93 - 00	EJ18	4	1,1	BKR6E-11	2756	14	LPG 1
Impreza		2.0	92	12.00 -	EJ20	4	1,1	BKR6E-11	2756	14	LPG 1
Impreza 2.0 RS		2.0	92	11.04 -	EJ20	4	1,1	BKR6E-11	2756	14	LPG 1
Impreza 2.0		2.0	110	01.08 - 02.10	EJ204	4	1,1	SILFR6A11	5468		SILFR6A11
Impreza 2.0		2.0	110	03.10 -	EJ204	4	1,1	SILFR6C11	7505		SILFR6C11
Impreza 2.0R		2.0	110	09.07 -	EK20	4	0,8	ILFR6B	6481		ILFR6B
Impreza R		2.0	118	06 -	EJ20	4	0,8	ILFR6B	6481		ILFR6B
Impreza Turbo		2.0	155	05.94 - 07.96	EJ20	4	0,8	PFR6G	4793		PFR7G
Impreza Turbo		2.0	160	03.94 - 00	EJ20	4	0,9	PFR6B	3500		PFR7B
Impreza WRX Turbo		2.0	160	12.00 -	EJ20	4	0,9	PFR6B	3500		PFR7B
Impreza WRX Turbo		2.0	165	11.02 -	EJ20	4	0,9	PFR6B	3500		PFR7B
Impreza WRX Turbo		2.0	169	06 -	EJ25	4	0,8	ILFR6B	6481		ILFR6B
Impreza WRX Sti		2.0	195	03 -	EJ20	4	0,8	PFR6G	4793		PFR7G
Impreza WRX Sti		2.0	236	02.04 -		4	0,8	PFR6G	4793		PFR7G
Impreza WRX		2.5	169	09.05 -	EJ25	4	0,8	ILFR6B	6481		ILFR6B
Impreza 2.5		2.5	169	08 -	N/A	4	0,8	ILFR6B	6481		ILFR6B
Impreza WRX Sti St1		2.5	206	09.05 -	EJ25	4	0,8	ILFR6B	6481		ILFR6B
Impreza WRX Sti		2.5	206	06 -	EJ25	4	0,8	ILFR6B	6481		ILFR6B
Impreza WRX Sti (GRF)		2.5	221	01.08 -	EJ25	4		SILFR6A	7913		

**JUSTY**

Justy 1.0		1.0	52	07 -	1KR-FE Daihatsu engine	3	1,1	ILFR6T11	4904		ILFR6T11
Justy 1000		1.0		85 - 03	EF10 Cat.	4	1,1	BPR6ES-11	4824	13	LPG 2
Justy 1200		1.2	55	87 - 03	EF12/EF12 Cat.	4	1,1	BPR6ES-11	4824	13	LPG 2
Justy 1300		1.3	50	10.95 - 03	G13BA	4	0,8	BPR6ES	7822	2	LPG 2
Justy		1.3	63	- 03	G13BB	4	1,1	BKR6E-11	2756	14	LPG 1
Justy G3X		1.3	69	09.03 -	M13A DOHC	4	1,1	BKR6E-11	2756	14	LPG 1
Justy G3X		1.5	73	09.03 -	M15A DOHC	4	1,1	IFR6J11	7658		IFR6J11

**LEGACY**

Legacy 1,8 Sedan		1.8	76	90 - 91	EJ18/4	4	1,1	BKR6E-11	2756	14	LPG 1
Legacy 1,8 Station		1.8	76	90 - 91	EJ18/4	4	1,1	BKR6E-11	2756	14	LPG 1
Legacy 1,8 Super Station		1.8	76	90 - 91	EJ18/4	4	1,1	BKR6E-11	2756	14	LPG 1
Legacy 2,0 Sedan		2.0	84	92 - 95	EJ20/4	4	1,1	BKR6E-11	2756	14	LPG 1
Legacy 2,0 Super Station		2.0	84	92 - 95	EJ20	4	1,1	BKR6E-11	2756	14	LPG 1
Legacy 2.0		2.0	85	05.94 -	EJ20	4	1,1	BKR6E-11	2756	14	LPG 1
Legacy 2,0		2.0	92	12.98 - 03	EJ20	4	1,1	BKR6E-11	2756	14	LPG 1
Legacy 2.0	B13BL	2.0	101	09.03 - 10.05	EJ20	4	1,1	BKR6E-11	2756	14	LPG 1
Legacy 2.0	B13BL	2.0	110	06.03 - 04.09	EJ204	4	0,8	ILFR6B	6481		ILFR6B

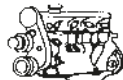
Code *l* kW

Cyl.

Stock-No.  
**VELINE**  
10-15-17-19-21-23-25

LPG/CNG

**SUBARU  
LEGACY**

Legacy 2.0	B14BM	2.0	110	04.09 -	EJ204	4	1,1	SILFR6C11	7505		SILFR6C11
Legacy 2.0	B13BL	2.0	121	06.05 - 04.09	EJ20X	4	0,8	ILFR6B	6481		ILFR6B
Legacy 2,0 Turbo Sedan		2.0	147	92 - 93	EJ20	4	0,8	PFR6B	3500		LPG 1
Legacy 2,0 Turbo Sup.Stat.		2.0	147	92 - 93	EJ20	4	0,8	PFR6B	3500		LPG 1
Legacy 2,0 Turbo		2.0	147	93 - 96	EJ20	4	0,8	PFR6G	4793		PFR7G
Legacy		2.2	94	05.94 - 02	EJ22	4	1,1	BKR6E-11	2756	14	LPG 1
Legacy 2,2 Station		2.2	96	94 - 02	EJ22	4	1,1	BKR6E-11	2756	14	LPG 1
Legacy 2,2 Sedan		2.2	100	90 - 93	EJ22	4	1,1	BKR6E-11	2756	14	LPG 1
Legacy 2,2 Super Station		2.2	100	90 - 94	EJ22/4	4	1,1	BKR6E-11	2756	14	LPG 1
Legacy Outback		2.5	110	96 - 02	EJ25	4	1,1	PFR6B-11	4014		PFR7B
Legacy 2,5 Outback		2.5	115	12.98 - 03	EJ25	4	1,1	BKR6E-11	2756	14	LPG 1
Legacy 2.5	B13BL	2.5	121	09.03 - 04.09	EJ25	4	1,1	PFR5B-11	2300		PFR6B
Legacy H6-3.0		3.0	154	01 - 03		6	1,1	PLFR6A-11	7654		LPG 7
Legacy Outback H6-3.0		3.0	154	01 - 03		6	1,1	PLFR6A-11	7654		LPG 7
Legacy 3.0 R	B13BL	3.0	180	09.03 - 06.09	EZ30	6	0,8	ILFR6B	6481		ILFR6B
Legacy 3.6		3.6	188	04.09 -	EZ5 H6	6	1,1	SILFR6C11	7505		SILFR6C11

**LIBERO**

Libero 1200		1.2	38	87 - 00	EF12	4	1,1	BPR6ES-11	4824	13	LPG 2
-------------	--	-----	----	---------	------	---	-----	-----------	------	----	-------

**M80**

M80 Mini Jumbo		0.8			M80	4	0,9	BKR6E	6962	28	LPG 1
----------------	--	-----	--	--	-----	---	-----	-------	------	----	-------

**OUTBACK**

Outback 2.5	BL / BP	2.5	121	09.03 -	EJ25	4	1,1	PFR5B-11	2300		PFR6B
Outback 3.0 R	BL / BP	3.0	180	11.03 -	EZ30	6	0,8	ILFR6B	6481		ILFR6B
Outback 3.6 R	BM / BR	3.6	191	09.09 -	EZ36D	6	1,1	SILFR6C11	7505		SILFR6C11

**PLEO**

Pleo	RA1 / RA2	0.66		10.01 - 01.04	EN07	4		KR8BI	4347		KR8BI
------	-----------	------	--	---------------	------	---	--	-------	------	--	-------

**R1**

R1	RJ1 / RJ2	0.66		06 -	EN07	4		KR8BI	4347		KR8BI
----	-----------	------	--	------	------	---	--	-------	------	--	-------

**R2**

R2	RC1 / RC2	0.66		12.03 -	EN07	4		KR8BI	4347		KR8BI
----	-----------	------	--	---------	------	---	--	-------	------	--	-------

**SVX**

SVX	CX	3.3	162	92 - 12.97	EG33	6	1,1	PFR6G-11	5555		PFR7G
-----	----	-----	-----	------------	------	---	-----	----------	------	--	-------

**TRIBECA**

Tribeca 3.0	B9	3.0	184	06 -	EZ30	6	0,8	ILFR6B	6481		ILFR6B
Tribeca 3.6	B9	3.6	190	09.07 -	EZ36D	6		SILFR6A	7913		SILFR6A

**VIVIO**

Vivio		0.7		03.92 -	MFI	4	1,1	BKR6E-11	2756	14	LPG 1
Vivio		0.7		03.92 -	Vergaser/Carb	4	1,1	BKR5E-11	6953	33	LPG 1

**SUZUKI****ALTO**

Alto (HA24V)		0.6		01.05 -	K6A	3		KR7AI	7789		KR7AI
Alto (SB308)		0.8	29	86 - 92	F8B	3	0,9	BPR5ES	7422	6	LPG 2
Alto (SH410)		1.0	39	94 - 00	G10B	4	0,8	BPR5EY	2828	9	LPG 2
Alto (AMF310)		1.0	50	04.09 -	K10B	3	1,1	IKR6G11	7980		IKR6G11
Alto (SH410)		1.0	53	94 - 12.00	G10B	4	0,8	BPR5EY	2828	9	LPG 2
Alto		1.0		01.01 -	G10B	4	0,9	BKR6E	6962	28	LPG 1
Alto (FF)		1.1	46	06.02 -	K10A / F10D DOHC 16V	4	0,8	DCPR7E	3932		LPG 8

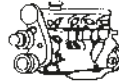

Code *l* kW

Cyl.



Stock-No.

**SUZUKI****ALTO**

Alto Lapin HE21S		1.6		01.02 -	K6A...	4	0,8	DCPR7E	3932		LPG 8
------------------	--	-----	--	---------	--------	---	-----	--------	------	--	-------

**BALENO**

Baleno (SY413)		1.3	63	04.95 -	G13BB	4	0,9	BKR6E	6962	28	LPG 1
Baleno (SY416)		1.6	72	04.95 -	G16B	4	0,9	BKR6E	6962	28	LPG 1
Baleno		1.6		95 -	G16A (16V)	4	0,9	BKR6E	6962	28	LPG 1
Baleno (SY418)		1.8	89	03.96 - 12.00	J18A	4	1,1	BKR6E-11	2756	14	LPG 1
Baleno (SY418)		1.8	89	11.00 -	16V	4	1,1	IFR6J11	7658		IFR6J11
Baleno D		1.9	46	98 -		4	█	Y-923U	3380	1	
Baleno TD		1.9	55	98 -		4	█	Y-923U	3380	1	

**CAPPUCCINO**

Cappuccino 660 12V Turbo		0.66	47	09.91 -	F6A DOHC Cat.	3	0,8	DCPR7EVX	1179		LPG 8
Cappuccino 660 12V Turbo		0.66	47	05.95 -	K6A DOHC Cat.	3	0,8	DCPR7EVX	1179		LPG 8

**CARRY**

Carry (DA51T/B,DB51T)		0.66		03.90 - 09.91	F6A 4Valve	3	0,8	DCPR7E	3932		LPG 8
Carry (DC51T/B,DD51T)		0.66		09.91 - 01.99	F6A 4Valve	3	0,8	DCPR7E	3932		LPG 8
Carry (DE51V,DF51V)		0.66		09.91 - 01.99	F6A 2Valve Turbo	3	0,9	BPR5E	7281	6	LPG 2
Carry (DE51V,DF51V)		0.66		09.91 - 01.99	F6A 4Valve	3	0,8	DCPR7E	3932		LPG 8
Carry (DC51T,DD51T)		0.66		04.97 - 01.99	F6A 2Valve Turbo	3	0,7	PGR5A	3987		PGR6A
Carry (DA52T,DB52T)		0.66		01.99 - 05.00	F6A 2Valve Turbo	3	0,9	BPR5E	7281	6	LPG 2
Carry (DA52T,DB52T)		0.66		01.99 - 09.01	F6A 4Valve	3	0,8	DCPR7E	3932		LPG 8
Carry (DA62T)		0.66		09.01 - 05.02	K6A 4Valve DOHC	3	0,8	DCPR7E	3932		LPG 8
Carry (DA63T)		0.66		05.02 -	K6A 4Valve DOHC	3	0,8	DCPR7E	3932		LPG 8
Carry (DA63T)		0.66		05.02 -	K6A 4Valve DOHC	3		KR7AI	7789		KR7AI
Carry		1.3		06.99 -	G13BB	4	0,9	BKR6E	6962	28	LPG 1
Carry Super (SK410)		1.0	31	92 - 99	F10A Cat.	4	0,9	BPR5ES	7422	6	LPG 2
Carry Super (SK410)		1.0	33	87 - 99	F10A u.Cat.	4	0,9	BPR5ES	7422	6	LPG 2
Carry Van		1.3		99 -	G13BB	4	0,9	BKR6E	6962	28	LPG 1

**ESCUDO**

Escudo		1.6	71	08.90 - 11.97	G16A	4	0,9	BKR6E	6962	28	LPG 1
Escudo		1.6	71	12.97 - 04.00	G16A	4	1,1	BKR6E-11	2756	14	LPG 1
Escudo		1.6	71	05.00 -	G16A	4	1,1	IFR6E11	6741		IFR6E11
Escudo		2.0		12.94 - 10.96	H20A	4	0,9	BKR6E	6962	28	LPG 1
Escudo		2.0		10.96 - 11.97	J20A	4	0,9	BKR6E	6962	28	LPG 1
Escudo		2.0		11.97 - 04.00	J20A	4	1,1	BKR6E-11	2756	14	LPG 1
Escudo		2.0		04.00 -	H25A	6	1,1	IFR5J11	7418		IFR6J11
Escudo		2.0		04.00 - 04.05	J20A	4	1,1	IFR5J11	7418		IFR6J11
Escudo (TD54W)		2.0		05.05 -	J20A	4	1,1	IFR6J11	7658		IFR6J11
Escudo		2.5		10.96 - 11.97	H25A	6	0,9	BKR6E	6962	28	LPG 1
Escudo		2.5		03.98 - 04.00	H25A	6	1,1	BKR6E-11	2756	14	LPG 1
Escudo (TD94W)		2.7		06.05 -	H27A	4	1,1	IFR6J11	7658		IFR6J11

**GRAND VITARA**

Grand Vitara	FT / GT	1.6	69	03.98 -	G16A / G16B	4	1,1	BKR6E-11	2756	14	LPG 1
Grand Vitara (only D)	FT / GT	1.6	69	01 -	G16A / G16B	4	1,1	IFR6J11	7658		IFR6J11
Grand Vitara TDiC (SQ420D)	FT / GT	2.0	64	05.00 -	RF	4	█	Y-701J	1566	39	
Grand Vitara Tdi II (SQ420D)	FT / GT	2.0	80	03.01 -	RHZ	4	█	Y-504J	1441	24	
Grand Vitara TD XL7(JA420D)	FT / GT	2.0	80	04 -	RHW	4	█	Y-504J	1441	24	
Grand Vitara 2.0 HDI	FT / GT	2.0	80	04.01 -	Hdi PSA	4	█	Y-504J	1441	24	
Grand Vitara	FT / GT	2.0	94	01.98 - 09.00	J20A	4	1,1	IFR6J11	7658		IFR6J11

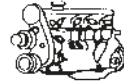
Code *l* kW

Cyl.



Stock-No.



LPG/CNG

## SUZUKI GRAND VITARA

Grand Vitara	FT / GT	2.0		10.00 -	J20	4	1,1	IFR5J11	7418		IFR6J11
Grand Vitara V6 ( SV620)	FT / GT	2.5	106	04.98 - 09.00	H25	6	1,1	BKR6E-11	2756	14	LPG 1
Grand Vitara V6 (SV620)	FT / GT	2.5	125	01.98 -	H25A	6	1,1	BKR6E-11	2756	14	LPG 1
Grand Vitara	FT / GT	2.5		10.00 -	H25	6	1,1	IFR5J11	7418		IFR6J11
Grand Vitara V6	FT / GT	2.7	127	09.01 -	H27A	6	1,1	IFR5J11	7418		IFR6J11
Grand Vitara XL7 (UBD) JB627W	FT / GT	2.7	135	04.03 - 08.08	H27A	6	1,1	IFR6J11	7658		IFR6J11
Grand Vitara (JB416)	JT	1.6	78	04.05 -	M16A VVT	4	1,1	IFR6J11	7658		IFR6J11
Grand Vitara 1.9 DDIS (JB419D)	JT	1.9	95	10.05 -	F9Q	4	█	Y-732J	5605	4	
Grand Vitara 1.9 DDIS Euro V	JT	1.9	95	03.06 - 08.08	F9QB	4	█	Y1036AS	96062		
Grand Vitara (JB420)	JT	2.0	103	09.05 -	J20A	4	1,1	IFR5J11	7418		IFR6J11
Grand Vitara (JB420)	JT	2.0	103	09.05 -	M20A	4	1,1	IFR5E11	7994		IFR6E11
Grand Vitara 2.4 (JB424)	JT	2.4	124	06.08 -	J24B	4	1,1	SILFR6A11	5468		

## IGNIS

Ignis II 1.3 DDiS	RM413D	1.3	51	09.03 -	Z13DT	4	█	Y8003J	97256	62	
Ignis 1.3	RG413	1.3	61	10.00 -	M13A	4	1,1	IFR6J11	7658		IFR6J11
Ignis II 1.3	RM413	1.3	69	10.03 -	M13A mit V V T	4	1,1	IFR6J11	7658		IFR6J11
Ignis II 1.5	RM415	1.5	73	08.03 -	M15A mit V V T	4	1,1	IFR6J11	7658		IFR6J11
Ignis II 1.5I Sport	RG415	1.5	80	08.03 -	M15A	4	1,1	IFR6J11	7658		IFR6J11

## JIMNY

Jimny Cabrio	FJ	1.3	59	10.98 -	G13BB	4	0,9	BKR6E	6962	28	LPG 1
Jimny	FJ	1.3	60	05.01 - 07.04	M13A	4	1,1	IFR6J11	7658		IFR6J11
Jimny	FJ	1.3	63	08.05 -	M13A	4	1,1	IFR6J11	7658		IFR6J11
Jimny DDiS (SN415D)	FJ	1.5	48	12.03 -	K9K	4	█	Y-732J	5605	4	
Jimny DDiS (SN415D)	FJ	1.5	63	08.05 -	K9K 266	4	█	Y-732J	5605	4	

## KIZASHI

Kizashi 2.4	FR	2.4	131	10.10 -	J24B	4	1,1	SILFR6A11	5468		
-------------	----	-----	-----	---------	------	---	-----	-----------	------	--	--

## LIANA

Liana	ER	1.3	66	03.01 - 01.04	M13A	4	1,1	BKR6E-11	2756	14	LPG 1
Liana	ER	1.3	66	02.04 -	M13A	4	1,1	IFR6J11	7658		IFR6J11
Liana DDiS (RH414D)	ER	1.4	66	07.04 -	DV4 8HY	4	█	YE04	1684	40	
Liana	ER	1.6	78	03.01 - 01.04		4	1,1	BKR6E-11	2756	14	LPG 1
Liana	ER	1.6	78	02.04 -	M16A	4	1,1	IFR6J11	7658		IFR6J11

## SAMURAI

Samurai		1.0	33	90 -	F10A	4	0,9	BPR5ES	7422	6	LPG 2
Samurai (SJ413)		1.3	51	90 -	G13BA Cat.	4	0,9	BPR5ES	7422	6	LPG 2
Samurai		1.3	51	92 -	G13BA	4	0,9	BPR5ES	7422	6	LPG 2
Samurai Pick-up		1.3	51	10.99 - 10.00	G13BA	4	0,9	BPR5ES	7422	6	LPG 2
Samurai TD		1.9	46	09.98 -	XUD9	4	█	Y-923U	3380	1	

## SUPER CARRY

SK 410 Super Carry		1.0	31	85 -	F10A	4	0,9	BPR5ES	7422	6	LPG 2
--------------------	--	-----	----	------	------	---	-----	--------	------	---	-------

## SPLASH

Splash 1.0 (A5B310)		1.0	48	01.08 - 07.11	K10B	3	1,1	IKR6G11	7980		IKR6G11
Splash 1.2 (A5B412)		1.2	63	01.08 -	K12B	4	1,1	IKR6G11	7980		IKR6G11
Splash 1.2 VVT (A5B412)		1.2	69	09.10 -	K12B	4	1,1	IKR6G11	7980		IKR6G11
Splash 1.3 DDiS (A5B413D)		1.3	55	01.08 -	D13A	4	█	Y8003J	97256	62	

## SWIFT

Swift II 1.0	SF310	1.0	37	03.89 - 05.01	G10A	3	0,8	BPR6ES	7822	2	LPG 2
Swift II 1.0	SF310	1.0	39	09.91 - 05.01	G10A	3	0,8	BPR6ES	7822	2	LPG 2
Swift II 1.0	SF310	1.0	40	03.89 - 12.91	G10A	3	0,8	BPR6ES	7822	2	LPG 2

Code *l* kW

Cyl.

Stock-No.  
**V-TUNE**  
E-POWER

LPG/CNG

**SUZUKI****SWIFT**

Swift II 1.3	SF413	1.3	50	03.89 - 05.01	G13A	4	0,8	BPR6ES	7822	2	LPG 2
Swift II 1.3 4WD	SF413	1.3	50	03.89 - 05.01	G13A	4	0,8	BPR6ES	7822	2	LPG 2
Swift II 1.3	SF413	1.3	52	03.89 - 12.91	G13A	4	0,8	BPR6ES	7822	2	LPG 2
Swift II 1.3 Gti	SF413	1.3	74	03.89 - 05.01	G13B	4	0,8	BPR6ES	7822	2	LPG 2
Swift II 1.6	SF416	1.6	68	01.90 - 05.01	G16B	4	0,9	BKR6E	6962	28	LPG 1
Swift II 1.6	SF416	1.6	70	11.89 - 12.91	G16B	4	0,9	BKR6E	6962	28	LPG 1
Swift III 1.3 DDiS	RS413D	1.3	52	08.05 -	Z13DT	4	█	Y8003J	97256	62	
Swift III 1.3 DDiS	RS413D	1.3	55	10.07 -	D13A / Z13DTJ	4	█	Y8003J	97256	62	
Swift III 1.3 4X4	RS413	1.3	66	01.06 -	M13A	4	1,1	IFR6J11	7658		IFR6J11
Swift III 1.3	RS413	1.3	68	02.05 -	M13A	4	1,1	IFR6J11	7658		IFR6J11
Swift III 1.5	RS415	1.5	75	02.05 -	M15A	4	1,1	IFR6J11	7658		IFR6J11
Swift III 1.6 Sport	RS416	1.6	92	05.06 -	M16A	4	1,1	IFR6J11	7658		IFR6J11
Swift IV 1.2	AZG41	1.2	66	10.10 -	K12B	4	1,1	IKR6G11	7980		IKR6G11
Swift IV 1.2	AZG41	1.2	69	10.10 -	K12B	4	1,1	IKR6G11	7980		IKR6G11

**SX4**

SX4 1.5	RW415	1.5	73	06.06 -	M15A	4	1,1	IFR6J11	7658		IFR6J11
SX4 1.5 VVT	RW415	1.5	82	07.09 -	M15A VVT	4	1,1	IFR6J11	7658		IFR6J11
SX4 1.6 VVT	RW416	1.6	79	06.06 -	M16A VVT	4	1,1	IFR6J11	7658		IFR6J11
SX4 1.6 VVT	RW416	1.6	88	07.09 -	M16A VVT	4	1,1	IFR6J11	7658		IFR6J11
SX4 1.9 DDiS	RW419D	1.9	88	06.06 -	D19AA	4	█	Y1030J	90828	70	
SX4 2.0 DDiS	RW420D	2.0	99	07.09 -	D20AA	4	█	Y9003AS	94251	78	

**VITARA**

Vitara (SE416) Typ 2		1.6	59	- 98	G16A SOHC	4	0,9	BPR5ES	7422	6	LPG 2
Vitara		1.6	59	91 - 98	G16B Cat.	4	0,8	BPR6ES	7822	2	LPG 2
Vitara (SE416) Typ 1		1.6	60	88 - 98	G16A SOHC Cat.	4	0,9	BPR5ES	7422	6	LPG 2
Vitara		1.6	60	91 - 98	G16A	4	0,9	BPR5ES	7422	6	LPG 2
Vitara Long		1.6	71	91 - 98	G16B SOHC Cat.	4	0,9	BKR6E	6962	28	LPG 1
Vitara 16V		1.6	71	04.95 - 98	G16A	4	0,9	BKR6E	6962	28	LPG 1
Vitara		1.6		10.00 -	G16A	4	1,1	IFR6E11	6741		IFR6E11
Vitara TD		1.9	50	04.96 - 03.98	XUD9A	4	█	Y-938R	5267	1	
Vitara TD		1.9	55	97 - 98		4	█	Y-923U	3380	1	
Vitara TD		1.9	66	05.00 -	XUD... PSA Group	4	█	Y-923U	3380	1	
Vitara D		2.0	52	12.94 - 03.98	RFL-4	4	█	Y-701J	1566	39	
Vitara (SV620)		2.0	100	06.95 -	H20A	6	0,9	BKR6E	6962	28	LPG 1
Vitara		2.0			J20A	6	0,9	BKR6E	6962	28	LPG 1
Vitara V6 (SV620)		2.5	125	05.98 -	H25A	6	1,1	BKR6E-11	2756	14	LPG 1
Vitara		1.6	70	09.93 - 98	G16B	4	0,9	BKR6E	6962	28	LPG 1

**WAGON R+**

Wagon R+ 12V		1.0	44	03.05 -	Z10XEP	3	1,1	ZFR5F-11	2262		LPG 6
Wagon R+ (SR410)		1.0	48	97 -	K10A	4	0,8	DCPR7E	3932		LPG 8
Wagon R+		1.0	55	02.04 -	G10	4	1,1	BPR6ES-11	4824	13	LPG 2
Wagon R+		1.2	51	98 -	K12A	4	0,8	DCPR7E	3932		LPG 8
Wagon R+ 16V		1.2	59	03.05 -	Z12XEP	4	1,1	ZFR5F-11	2262		LPG 6
Wagon R+ DDiS (RB413D)		1.3	51	09.03 -	Z13DT	4	█	Y8003J	97256	62	
Wagon R GL		1.3	56	04.00 -	G13BB	4	1,1	BKR6E-11	2756	14	LPG 1
Wagon R+		1.3	68	02.04 -	M13A mit VVT	4	1,1	IFR6J11	7658		IFR6J11
Wagon R+		1.3	69		G13BB	4	1,1	BKR6E-11	2756	14	LPG 1

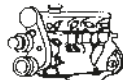
Code *l* kW

Cyl.



Stock-No.



LPG/CNG

**SUZUKI****X-90**

X-90	EL	1.6	71	10.95 -	G16A	4	0,9	BKR6E	6962	28	LPG 1
X-90	EL	1.6	71	03.96 -	G16B/G16W	4	0,9	BKR6E	6962	28	LPG 1

**TOFAS**

124 Serce		1.3	48	09.83 -		4	0,7	BP6ES	7811	4	LPG 2
131 Dogan		1.6	55	03.81 -		4	0,7	BP6ES	7811	4	LPG 2
131 Dogan S/SX/SLX		1.6	55	06.92 -		4	0,8	BPR6ES	7822	2	LPG 2
131 Kartal L		1.6	55	03.81 - 06.92		4	0,7	BP6ES	7811	4	LPG 2
131 Kartal SL / SLX		1.6	55	06.92 -		4	0,8	BPR6ES	7822	2	LPG 2
Sahin		1.6	55	02.82 -		4	0,7	BP6ES	7811	4	LPG 2
Tempra		1.6	63	11.90 -		4	0,8	BPR6ES	7822	2	LPG 2
Tempra i.e.		2.0	88	07.92 -		4	0,8	BPR6ES	7822	2	LPG 2

**TOFAS / FIAT**

Brava 16V		1.2		11.98 - 09.01	16V	4	0,9	DCPR8E-N	5692		LPG 8
Brava 1.4 12V		1.4		10.95 - 10.98	12V	4		BKR6EKC	2848	26	LPG 1
Bravo 16V		1.2		11.98 - 09.01	16V	4	0,9	DCPR8E-N	5692		LPG 8
Bravo 1.4 12V		1.4		10.95 - 10.98	12V	4		BKR6EKC	2848	26	LPG 1
Doblo 16V		1.3		11.01 -	MPI 16V	4	0,9	DCPR8E-N	5692		LPG 8
Marea 1.4 12V		1.4		10.96 - 02.99	12V	4		BKR6EKC	2848	26	LPG 1
Marea 2.0 20V		2.0		10.96 - 02.99	20V	4		BKR6EKC	2848	26	LPG 1
Palio 1.2 i.e.		1.2		10.01 -	16V	4	0,9	DCPR8E-N	5692		LPG 8
Palio Weekend 1.2 i.e.		1.2		10.01 -	16V	4	0,9	DCPR8E-N	5692		LPG 8
Palio 16V		1.3		03.00 -	MPI 16V	4	0,9	DCPR8E-N	5692		LPG 8
Palio Weekend 16V		1.3		03.00 -	MPI 16V	4	0,9	DCPR8E-N	5692		LPG 8
Palio 1.4 i.e.		1.4		03.98 - 09.01		4		BKR5EK	7956	23	LPG 1
Palio Weekend 1.4 i.e.		1.4		09.98 - 06.01		4		BKR5EK	7956	23	LPG 1
Siena 16V		1.3		03.00 -	MPI 16V	4	0,9	DCPR8E-N	5692		LPG 8
Siena 1.4 i.e.		1.4		05.98 - 06.01		4		BKR5EK	7956	23	LPG 1
Stilo 16V		1.2		10.01 -	16V	4	0,9	DCPR8E-N	5692		LPG 8
Stilo 1.6 16V		1.6		10.01 -	16V	4	0,9	BKR5EZ	7642	36	LPG 1
Stilo S.W. 1.6 16V		1.6		01.03 -	16V	4	0,9	BKR5EZ	7642	36	LPG 1
Stilo 1.8 16V		1.8		10.01 -	16V	4	0,9	BKR6EZ	4619	38	LPG 1
Stilo S.W. 1.8 16V		1.8		01.03 -	16V	4	0,9	BKR6EZ	4619	38	LPG 1

**TOYOTA****4 RUNNER**

4 Runner		2.4	82	89 - 95	22R/22RE Cat.	4	0,8	BPR5EY	2828	9	LPG 2
4 Runner D		2.4			2L	4	█	Y-118R	2187		
4 Runner TD		2.4		01.90 - 12.96	2L-T	4	█	Y-715R	5376		
4 Runner D		2.5		01.93 -	2L-T	4	█	Y-715R	5376		
4 Runner (RZN185)		2.7	112	98 - 12.99	3RZ-FE	6	0,8	BKR5EYA	2087		LPG 1
4 Runner (VZN185)		2.7	112	98 - 12.99	3RZ-FE	6	0,8	BKR5EYA	2087		LPG 1
4 Runner (RZN180,185,VZN180 185)		2.7		01.00 -	3RZ-FE	6	0,8	BKR5EYA	2087		LPG 1
4 Runner		2.8			2L	4	█	Y-168R	2162		
4 Runner		2.8		93 - 96	3L	4	█	Y-715R	5376		
4 Runner D		2.8		01.93 - 96	3L	4	█	Y-715R	5376		
4 Runner (.../KZN185)		3.0	92	10.93 - 03.96	1KZ-T	4	█	Y1013J	94470	63	
4 Runner		3.0	105	89 - 96	3VZ-E Cat.	6	0,8	BKR5EYA	2087		LPG 1
4 Runner (RZN185)		3.4	136	98 - 12.99	5VZ-FE	6		BKR5EKB-11	3967		

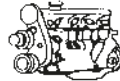
Code *l* kW

Cyl.

Stock-No.  
**VEFINE**  
BY-PROMOTER

LPG/CNG

**TOYOTA****4 RUNNER**

4 Runner (VZN185)		3.4	136	98 - 12.99	5VZ-FE	6		BKR5EKB-11	3967		
4 Runner (RZN180,185,VZN180,185)		3.4		01.00 -	5VZ-FE	6		BKR5EKB-11	3967		
4 Runner (GRN210,215)		4.0		01.04 -	1GR-FE	6	1,1	LFR6C-11	5788		

**AURIS**

Auris 1.33 VVT-i (NRE150)		1.33	73	01.10 -	1NR-FE	4	1,1	ILKAR7B11	4912		ILKAR7B11
Auris 1.33 VVT-i (NRE150)		1.33	74	11.08 - 01.10	1NR-FE	4	1,1	ILKAR7B11	4912		ILKAR7B11
Auris 1.4 D-4D (ADE150,157)(NDE150,151)		1.4	66	03.07 -	1ND-TV	4	█	Y-542J	5513	45	
Auris 1.4 VVT-i (ZRE151)		1.4	71	10.06 -	4ZZ-FE	4	1,1	BKR5EYA-11	2526	39	LPG 1
Auris 1.6 VVT-i (ZRE151)		1.6	91	10.06 -	1ZR-FE	4	1,1	ILKAR7B11	4912		ILKAR7B11
Auris 1.6 (ZRE151)		1.6	97	12.08 -	1ZR-FAE	4	1,1	ILKAR7B11	4912		ILKAR7B11
Auris 1.8 Hybrid (ZWE 150)		1.8	73	09.10 -	2ZR-FXE	4	1,1	ILKAR7B11	4912		ILKAR7B11
Auris 1.8 (ZZE150)(ZRE151,152)		1.8	100	10.06 -	2ZR-FE	4	1,1	ILKAR7B11	4912		ILKAR7B11
Auris 1.8 (ZRE152H)		1.8	108	10.09 -	2ZR-FAE	4	1,1	ILKAR7B11	4912		ILKAR7B11
Auris 2.2 D-CAT (NDE150)(ADE150,157)		2.2	130	03.07 -	2ADFHV	4	█	Y1012J	92083	65	

**AVALON**

Avalon (MCX20)		3.0		01.01 - 12.01	1MZ-FE	6		BKR6EKB-11	3583		
Avalon (MCX20)		3.0		01.02 -	1MZ-FE	6		BKR6EKP-11	3452		

**AVENSIS**

Avensis (AT220,221,ST220)		1.6	81	04.98 -	4A-FE	4	1,1	BKR6EYA-11	4073		LPG 1
Avensis (AZT220)		1.6		01.02 -	3ZZ-FE	4	1,1	BKR5EYA-11	2526	39	LPG 1
Avensis (ST220)		1.6		01.02 -	3ZZ-FE	4	1,1	BKR5EYA-11	2526	39	LPG 1
Avensis (ZZT220, 221)		1.6		01.02 -	3ZZ-FE	4	1,1	BKR5EYA-11	2526	39	LPG 1
Avensis (ZZT250,251)(AZT250)		1.6		09.03 -	3ZZ-FE	4	1,1	BKR5EYA-11	2526	39	LPG 1
Avensis (AT220,221,ST220)		1.8	81	01.98 -	7A-FE	4	1,3	BKR6EP-13	2550		
Avensis (ST220)		1.8	95	01.02 -	1ZZ-FE	4	1,1	BKR5EYA-11	2526	39	LPG 1
Avensis (ZZT220, 221)		1.8	95	01.02 -	1ZZ-FE	4	1,1	BKR5EYA-11	2526	39	LPG 1
Avensis (AZT220)		1.8		01.02 -	1ZZ-FE	4	1,1	BKR5EYA-11	2526	39	LPG 1
Avensis (ZZT250,251)(AZT250)		1.8		09.03 -	1ZZ-FE	4	1,1	BKR5EYA-11	2526	39	LPG 1
Avensis (CT220)		2.0	66	01.98 -	2C-T	4	█	Y-532J	7782		
Avensis (CT220)		2.0	66	01.98 -	2C-TE	4	█	Y-532J	7782		
Avensis (AT220,221,ST220)		2.0	94	01.98 -	3S-FE	4		BKR6EKP-11	3452		
Avensis (AZT220)		2.0	110	07.00 - 02.03	1AZ-FSE	4	1,1	HB6BIX-11P	5705		HB6BIX-11P
Avensis (AZT220)		2.0		01.02 -	3S-FE	4		BKR6EKB-11	3583		
Avensis (ST220)		2.0		01.02 -	3S-FE	4		BKR6EKB-11	3583		
Avensis (ZZT220, 221)		2.0		01.02 -	3S-FE	4		BKR6EKB-11	3583		
Avensis (1AZ-FE)		2.0		01.03 -	1AZ-FE with 3way cat	4	1,1	IFR6T11	4589		IFR6T11
Avensis (1AZ-FE)		2.0		01.03 -	1AZ-FE without cat	4	1,1	BKR6EYA-11	4073		LPG 1
Avensis (AZT250 / W)		2.0	108	03.03 - 10.08	1AZ-FSE	4	1,1	HB6BIX-11P	5705		HB6BIX-11P
Avensis 2.2D-Cat (ADT251)		2.2	130	06.05 - 10.08	2ADFHV	4	█	Y1012J	92083	65	
Avensis (AZT251/ W)		2.4	120	09.05 -	2AZ-FSE	4	1,1	HB6BIX-11P	5705		HB6BIX-11P
Avensis 2 (ZZT250;251)(AZT250)		1.6	81	03.03 - 09	3ZZ-FE	4	1,1	BKR5EYA-11	2526	39	LPG 1
Avensis 2 (ZZT250;251)(AZT250)		1.8	95	03.03 - 09	1ZZ-FE	4	1,1	BKR5EYA-11	2526	39	LPG 1
Avensis 2 (CDT250) D- Cat		2.0	85	03.03 - 04.06	1CD-FTV	4	█	Y-531J	5467	44	
Avensis 2 (ATZ250)		2.0	110	01.03 - 09	1AZ-FE V V T-i	4	1,1	IFR6T11	4589		IFR6T11
Avensis 3 (ZRT270)		1.6	81	04.08 -	1ZRFAE	4	1,1	ILKAR7B11	4912		ILKAR7B11
Avensis 3 (ZRT270)		1.6	97	11.08 -	1ZRFAE	4	1,1	ILKAR7B11	4912		ILKAR7B11
Avensis 3 (ZRT271)		1.8	108	11.08 -	2ZRFAE	4	1,1	ILKAR7B11	4912		ILKAR7B11
Avensis 3 (ZRT272)		2.0	112	11.08 -	3ZRFAE	4	1,1	ILKAR7B11	4912		ILKAR7B11
Avensis 3 D-CAT (ADT271)		2.2	130	02.09 -	2ADFHV	4	█	Y1012J	92083	65	

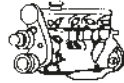

Code *l* kW

Cyl.



Stock-No.



LPG/CNG

**TOYOTA  
AVENSIS VERSO**

Avensis Verso (ACM20)		2.0	110	05.01 -	1AZ-FE	4	1,1	IFR6T11	4589		IFR6T11
Avensis Verso (ACM20)		2.4		01.04 -	2AZ-FE	4	1,1	BKR6EYA-11	4073		LPG 1

**AYGO**

Aygo	B10	1.0	50	05.05 -	1KR-FE	3	1,1	LFR6C-11	5788		
Aygo	B10	1.4	52	06.05 -		4		YE05	91322	73	

**CAMRY**

Camry		2.0	62	90 - 91	2C-T	4		Y-703R	3782		
Camry (SV20,21,25,VZV21)		2.0	89	86 -	3S-FE Cat.	4	1,1	BCPR6EY-11	3720		LPG 3
Camry (SV20,21,25,VZV21)		2.0	94	87 -	3S-FE	4	1,1	BCPR6EY-11	3720		LPG 3
Camry		2.0		- 92	1-CT	4		Y-146R	7492		
Camry (ACV30,31)		2.0		08.01 -	1AZ-FE	4	1,1	IFR6T11	4589		IFR6T11
Camry (MCV30)		2.0		08.01 -	1AZ-FE	4	1,1	IFR6T11	4589		IFR6T11
Camry (SXV10,VCV10)		2.2	100	92 -	5S-FE	4	1,1	BKR6EYA-11	4073		LPG 1
Camry MCV20		2.2	100	08.96 - 12.99	5S-FE with 3way cat	4		BKR6EKP-11	3452		
Camry MCV20		2.2	100	08.96 - 12.99	5S-FE without 3way cat	4		BKR6EKB-11	3583		
Camry SXV20		2.2	100	08.96 - 12.99	5S-FE with 3way cat	4		BKR6EKP-11	3452		
Camry SXV20		2.2	100	08.96 - 12.99	5S-FE without 3way cat	4		BKR6EKB-11	3583		
Camry (MCV20)		2.2		98 - 12.99	5S-FE	4		BKR6EKP-11	3452		
Camry (SVX20)		2.2		98 - 12.99	5S-FE	4		BKR6EKP-11	3452		
Camry (SVX20, MCV20)		2.2		01.00 -	5S-FE	4		BKR6EKB-11	3583		
Camry (ACV30,31)		2.4	112	08.01 -	2AZ-FE	4	1,1	IFR6T11	4589		IFR6T11
Camry (MCV30)		2.4	112	08.01 -	2AZ-FE	4	1,1	IFR6T11	4589		IFR6T11
Camry (ACV 40)		2.4	116	01.06 -	2AZ-FE	4	1,1	IFR6T11	4589		IFR6T11
Camry (SV21,25,VZV21)		2.5	118	88 - 92	2VZ-FE Cat.	6	1,1	BCPR6EP-11	3350		LPG 3
Camry (SVX20, MCV20)		3.0	137	01.00 -	1MZ-FE V6	6		BKR6EKP-11	3452		
Camry (SXV10,VCV10)		3.0	138	92 -	3VZ-FE	6	1,1	BCPR6EP-11	3350		LPG 3
Camry MCV20		3.0	138	08.96 - 12.99	1MZ-FE with 3way cat	6		BKR6EKP-11	3452		
Camry MCV20		3.0	138	08.96 - 12.99	1MZ-FE without 3way cat	6		BKR6EKB-11	3583		
Camry SXV20		3.0	138	08.96 - 12.99	1MZ-FE with 3way cat	6		BKR6EKP-11	3452		
Camry SXV20		3.0	138	08.96 - 12.99	1MZ-FE without 3way cat	6		BKR6EKB-11	3583		
Camry (ACV30,31)		3.0		08.01 -	1MZ-FE	6	1,1	IFR6T11	4589		IFR6T11
Camry (MCV30)		3.0		08.01 -	1MZ-FE	6	1,1	IFR6T11	4589		IFR6T11

**CARINA E**

Carina E (AT190,191,ST191)		1.6	77	93 - 97	4A-FE Lean Burn engine	4	1,3	BKR6EP-13	2550		
Carina E (AT190,191,ST191)		1.6		93 - 97	4A-FE Standard engine	4	0,8	BKR6EYA	2249		LPG 1
Carina E (AT190,191,ST191)		1.8	79	95 -	7A-FE	4	1,3	BKR6EP-13	2550		
Carina E (AT190,191,ST191)		2.0	98	93 - 97	3S-FE Cat.	4	1,1	BKR6EYA-11	4073		LPG 1
Carina E (AT190,191,ST191)		2.0	116	93 -	3S-GE Cat.	4	0,8	BKR6EP-8	2215		LPG 1
Carina E		2.0		02.92 -	2C	4		Y-703R	3782		
Carina E (DK)		1.6		92 -	4A-FE Cat.	4	0,8	BKR6EYA	2249		LPG 1
Carina E (DK)		1.6		92 -	4A-FE Cat. Lean Burn	4	1,3	BKR6EP-13	2550		
Carina E (DK)		1.8		92 -	7A-FE Cat. Lean Burn	4	1,3	BKR6EP-13	2550		
Carina E (DK)		2.0		92 -	3S-FE Cat.	4	1,1	BKR6EYA-11	4073		LPG 1
Carina E (DK)		2.0		92 -	3S-FE Cat. Lean Burn	4	1,1	BKR6EP-11	2978		LPG 1

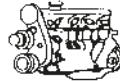
Code *l* kW

Cyl.



Stock-No.

**TOYOTA****CARINA II**

Carina II (AT171,177,ST171)		1.6	66	87 - 92	4A-F Cat.	4	0,8	BCRE527Y	2074		
Carina II (AT171,177,ST171)		1.6	72	90 - 92	4A-FE	4	0,8	BCPR5EY	1266		LPG 3
Carina II (AT171,177,ST171)		1.6	72	90 - 92	4A-FE Cat.	4	1,1	BCPR6EIX-11	4919		LPG 3
Carina II (AT171,177,ST171)		1.6	72	90 - 92	4A-FE with EGR	4	0,8	BCPR5EY	1266		LPG 3
Carina II (AT171,177,ST171)		1.6	72	90 - 92	4A-FE without EGR	4	1,1	BCPR6EIX-11	4919		LPG 3
Carina II (AT171,177,ST171)		2.0	89	88 - 92	3S-F	4	1,1	BCPR6EY-11	3720		LPG 3
Carina II (AT171,177,ST171)		2.0	98	88 - 92	3S-FE Cat.	4	1,1	BCPR6EY-11	3720		LPG 3
Carina II		2.0		- 92	2C	4		Y-146R	7492		
Carina II		2.0		93 -	2C	4		Y-703R	3782		

**CELICA**

Celica (AT180,ST182,184,185)		1.6	77	90 - 94	4A-FE	4	0,8	BCPR5EY	1266		LPG 3
Celica (AT200,ST202,204,205)		1.8	85	03.94 -	7A-FE	4	0,8	BKR6EYA	2249		LPG 1
Celica S (ZZT230)		1.8	105	08.99 -	1ZZ-FE	4	1,1	BKR5EYA-11	2526	39	LPG 1
Celica (ZZT230,231)		1.8		08.99 -	1ZZ-FE	4	1,1	BKR5EYA-11	2526	39	LPG 1
Celica (ZZT230,231)		1.8		08.99 -	2ZZ-GE	4	1,1	IFR6T11	4589		IFR6T11
Celica (AT200,ST202,204,205)		2.0	95	94 -	3S-FE	4	1,1	BKR6EYA-11	4073		LPG 1
Celica (AT180,200,ST182,184,185, 202,204,205)		2.0	115	90 -	3S-GE Cat.	4	0,8	BKR6EP-8	2215		LPG 1
Celica (AT180,200,ST182,184,185, 202,204,205)		2.0	129	03.94 -	3S-GE	4	0,8	BKR6EP-8	2215		LPG 1
Celica		2.0		90 - 99	3S-GTE	4	0,8	BKR6EP-8	2215		LPG 1
Celica (AT200)		2.0		98 -	3S-GE	4	0,8	BKR6EP-8	2215		LPG 1
Celica (ST202,204,205)		2.0		98 -	3S-GE	4	0,8	BKR6EP-8	2215		LPG 1
Celica (AT180,ST182,184,185)		2.2	100	91 -	5S-FE Cat.	4	1,1	BKR6EP-11	2978		LPG 1
Celica (AT200)		2.2		98 -	5S-FE	4	1,1	BKR6EP-11	2978		LPG 1
Celica (ST202,204,205)		2.2		98 -	5S-FE	4	1,1	BKR6EP-11	2978		LPG 1
Celica Supra		3.0			7M-GE	6	0,9	BCPR6EY	1146		LPG 3
Celica Turbo (AT200,ST202,204,205)		2.0	150	90 -	3S-GTE	4	0,8	BKR6EP-8	2215		LPG 1

**COROLLA**

Corolla		1.2			3K	4	0,9	BPR5ES	7422	6	LPG 2
Corolla (EE80,90,97,100,105,AE82, 92,95,101)		1.3	55	86 - 92	2E	4	1,1	BPR6EY-11	4228	10	LPG 2
Corolla (EE90,97,AE92,95)		1.3	55	90 - 92	2E-E	4	0,8	BPR5EY	2828	9	LPG 2
Corolla (EE105)		1.3	63	07.97 - 07	2E	4	0,8	BPR6EY	6427		LPG 2
Corolla 1.33 (NRE150)		1.33	74	10.08 -	1NR-FE	4	1,1	ILKAR7B11	4912		ILKAR7B11
Corolla		1.3		- 00	2A (8V SOHC)	4	0,8	BPR5EY	2828	9	LPG 2
Corolla (EE100,101,105,AE101,102)		1.3		92 - 97	4E-FE	4	0,8	BKR5EYA	2087		LPG 1
Corolla (EE100,101,105,AE101,102)		1.3		93 - 97	2E	4	0,8	BPR6EY	6427		LPG 2
Corolla (EE100,101,105,AE101,102)		1.3		94 - 07	2E	4	0,8	BPR6EY	6427		LPG 2
Corolla (EE100,101,105,AE101,102)		1.3		95 - 12.99	2E o.Cat.	4	1,1	BPR5EY-11	3028		LPG 2
Corolla		1.3		07.97 - 12.99	4E-FE	4	1,1	BKR5EYA-11	2526	39	LPG 1
Corolla (AE110,111,112,115)		1.3		98 - 12.99	2E	4	0,8	BPR6EY	6427		LPG 2
Corolla (AE110,111,112,115)		1.3		98 - 12.99	4E-FE	4		BKR5EKB-11	3967		
Corolla (EE110,111)		1.3		98 - 12.99	2E	4	0,8	BPR6EY	6427		LPG 2
Corolla (EE110,111)		1.3		98 - 12.99	4E-FE (16V DOHC)	4		BKR5EKB-11	3967		
Corolla (EE110,111,AE110-112,115, ZZE111,112)		1.3		01.00 - 07	2E	4	0,8	BPR6EY	6427		LPG 2
Corolla (EE110,111,AE110-112,115, ZZE111,112)		1.3		01.00 - 07	4E-FE	4		BKR5EKB-11	3967		
Corolla (NZE120,121)		1.3		10.01 - 07	2NZ-FE	4	1,1	BKR5EYA-11	2526	39	LPG 1

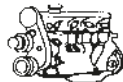
Code *l* kW

Cyl.



Stock-No.



LPG/CNG

**TOYOTA  
COROLLA**

Corolla (ZZE120,121,122,123)	1.3		10.01 - 07	2NZ-FE	4	1,1	BKR5EYA-11	2526	39	LPG 1
Corolla (EE100,101,105,AE101,102)	1.4	65	92 - 94	4E-FE	4	0,8	BKR6EYA	2249		LPG 1
Corolla Luna D-4D	1.4	66	04 - 07	1ND-TV	4		Y-542J	5513	45	
Corolla (EE110,111,AE110-112,115, ZZE111,112)	1.4	71	01.00 - 07	4ZZ-FE	4	1,1	BKR5EYA-11	2526	39	LPG 1
Corolla (NZE120,121 ZZE120,121,122,123)	1.4	71	01.02 - 07	4ZZ-FE	4	1,1	BKR5EYA-11	2526	39	LPG 1
Corolla	1.4		- 91		4	0,9	BPR5ES	7422	6	LPG 2
Corolla EE110,111,AE110,111,112,115	1.4		01.98 - 07	4E-FE	4		BKR5EKB-11	3967		
Corolla (NZE120,121)	1.4		10.01 - 07	4ZZ-FE	4	1,1	BKR5EYA-11	2526	39	LPG 1
Corolla (ZZE120,121,122,123)	1.4		10.01 - 07	4ZZ-FE	4	1,1	BKR5EYA-11	2526	39	LPG 1
Corolla	1.5			1N,1NT	4		Y-118R	2187		
Corolla (AE110,111,112,115)	1.5		98 - 12.99	5A-FE	4	1,1	BKR5EYA-11	2526	39	LPG 1
Corolla (EE110,111)	1.5		98 - 12.99	5A-FE	4	1,1	BKR5EYA-11	2526	39	LPG 1
Corolla (EE110,111,AE110-112,115, ZZE111,112)	1.5		01.00 - 07	5A-FE	4	1,1	BKR5EYA-11	2526	39	LPG 1
Corolla (NZE120,121)	1.5		10.01 - 07	1NZ-FE	4	1,1	BKR5EYA-11	2526	39	LPG 1
Corolla (ZZE120,121,122,123)	1.5		10.01 - 07	1NZ-FE	4	1,1	BKR5EYA-11	2526	39	LPG 1
Corolla	1.6	55		2T	4	0,8	BPR5EA-L	5823		LPG 2
Corolla (EE90,97,100,101,105,AE92, 95,101,102)	1.6	66	87 - 12.99	4A-F	4	0,8	BCRE527Y	2074		
Corolla (EE90,97,AE92,95)	1.6	77	89 - 91	4A-FE Cat.	4	0,8	BCPR5EY	1266		LPG 3
Corolla	1.6	81	07.97 - 07	4A-FE	4	1,1	BKR5EYA-11	2526	39	LPG 1
Corolla (EE110,111,AE110-112,115, ZZE111,112)	1.6	81	01.00 - 07	3ZZ-FE	4	1,1	BKR5EYA-11	2526	39	LPG 1
Corolla (NZE120,121)	1.6	81	10.01 - 07	3ZZ-FE	4	1,1	BKR5EYA-11	2526	39	LPG 1
Corolla (ZZE120,121,122,123)	1.6	81	10.01 - 07	3ZZ-FE	4	1,1	BKR5EYA-11	2526	39	LPG 1
Corolla (ZZE121)	1.6	81	11.01 - 07	3ZZ-FE	4	1,1	BKR5EYA-11	2526	39	LPG 1
Corolla (EE100,101,105,AE101,102)	1.6	84	92 - 94	4A-FE	4	0,8	BKR6EYA	2249		LPG 1
Corolla (EE90,97,AE92,95)	1.6	85	90 -	4A-GE Cat.	4	0,8	BKR6EP-8	2215		LPG 1
Corolla	1.6	85	93 -	4A-GE Cat.	4	0,8	BKR6EYA	2249		LPG 1
Corolla 1.6 (ZRE151)	1.6	91	11.06 - 12.08	1ZR-FE	4	1,1	ILKAR7B11	4912		ILKAR7B11
Corolla 1.6 (ZRE151)	1.6	97	01.09 -	1ZR-FAE / 1ZR-FE	4	1,1	ILKAR7B11	4912		ILKAR7B11
Corolla (EE100,101,105,AE101,102)	1.6		95 - 12.99	4A-FE	4	0,8	BKR6EYA	2249		LPG 1
Corolla (AE110,111,112,115)	1.6		98 - 12.99	4A-F	4	0,8	BCRE527Y	2074		
Corolla (AE110,111,112,115)	1.6		98 - 12.99	4A-FE	4	0,8	BKR6EYA	2249		LPG 1
Corolla (EE110,111)	1.6		98 - 12.99	4A-F	4	0,8	BCRE527Y	2074		
Corolla (EE110,111)	1.6		98 - 12.99	4A-FE	4	0,8	BKR6EYA	2249		LPG 1
Corolla (EE110,111,AE110-112,115, ZZE111,112)	1.6		01.00 - 07	4A-F	4	0,8	BCRE527Y	2074		
Corolla (EE110,111,AE110-112,115, ZZE111,112)	1.6		01.00 - 07	4A-FE	4	0,8	BKR6EYA	2249		LPG 1
Corolla Spacio (AE111)	1.6		01.00 - 07	4A-FE	4	0,8	BKR6EYA	2249		LPG 1
Corolla (NZE120,121)	1.8	99	10.01 - 07	1ZZ-FE	4	1,1	BKR5EYA-11	2526	39	LPG 1
Corolla (ZZE120,121,122,123)	1.8	99	10.01 - 07	1ZZ-FE	4	1,1	BKR5EYA-11	2526	39	LPG 1
Corolla (NZE120,121)	1.8	141	10.01 - 07	2ZZ-GE	4	1,1	IFR6T11	4589		IFR6T11
Corolla (ZZE120,121,122,123)	1.8	141	10.01 - 07	2ZZ-GE	4	1,1	IFR6T11	4589		IFR6T11
Corolla (ZZE123) Sport	1.8	141	02 - 07	2ZZ-GE	4	1,1	IFR6T11	4589		IFR6T11
Corolla (ZZE123) Sport	1.8	160	10.05 - 02.07	2ZZ-GE	4	1,1	IFR6T11	4589		IFR6T11
Corolla	1.8		- 92	1C	4		Y-146R	7492		
Corolla	1.8		12.92 -	1C	4		Y-703R	3782		
Corolla (EE100,101,105,AE101,102)	1.8		93 - 12.99	7A-FE	4	0,8	BKR6EYA	2249		LPG 1

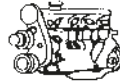
Code *l* kW

Cyl.



Stock-No.

V-TUNE  
E-POWER  
LPG/CNG**TOYOTA****COROLLA**

Corolla (AE110,111,112,115)		1.8		98 - 12.99	7A-FE	4	0,8	BKR6EYA	2249		LPG 1
Corolla (EE110,111)		1.8		98 - 12.99	7A-FE	4	0,8	BKR6EYA	2249		LPG 1
Corolla (EE110,111,AE110-112,115, ZZE111,112)		1.8		01.00 -	7A-FE	4	0,8	BKR6EYA	2249		LPG 1
Corolla 2.0 D-4D (E11,CDE110)		2.0	66	09.00 - 01.02	1CD-FTV	4	█	Y-531J	5467	44	
Corolla 2.0 D-4D (E12,CDE120)		2.0	66	01.02 - 05.04	1CD-FTV	4	█	Y-531J	5467	44	
Corolla 2.0 D-4D (E12,CDE120)		2.0	81	11.01 - 04.03	1CD-FTV	4	█	Y-531J	5467	44	
Corolla 2.0 D-4D (E12,CDE120)		2.0	85	05.03 - 05.08	1CD-FTV	4	█	Y-531J	5467	44	
Corolla 4WD		1.6	84	93 -	4A-FE	4	0,8	BCPR5EY	1266		LPG 3
Corolla 4WD		1.6		95 -	4A-FE	4	0,8	BCPR5EY	1266		LPG 3

**COROLLA VERSO**

Corolla Verso (ZZE121, 122)		1.6		09.01 - 07	3ZZ-FE	4	1,1	BKR5EYA-11	2526	39	LPG 1
Corolla Verso (ZNR10)		1.6		08.05 - 07	3ZZ-FE	4	1,1	BKR5EYA-11	2526	39	LPG 1
Corolla Verso (ZNR10)		1.8	99	08.05 - 07	1ZZ-FE	4	1,1	BKR5EYA-11	2526	39	LPG 1
Corolla Verso D-4D(E12,CDE120)		2.0	66	01.02 - 05.04	1CD-FTV	4	█	Y-531J	5467	44	
Corolla Verso D-4D(CE120,CDE120)		2.0	85	10.01 - 07	1CD-FTV	4	█	Y-531J	5467	44	
Corolla Verso D-4D(ZER,CUR10)		2.0	85	04.04 - 08.05	1CD-FTV	4	█	Y-531J	5467	44	
Corolla Verso (ZZE121, 122)		2.0		09.01 - 07	1ZZ-FE	4	1,1	BKR5EYA-11	2526	39	LPG 1
Corolla Verso (AUR10) D-Cat		2.2	130	08.05 - 03.09	2ADFHV	4	█	Y1012J	92083	65	

**CORONA**

Corona (AT171,177,ST171)		1.6	66	88 - 92	4A-F Cat.	4	0,8	BCRE527Y	2074		
Corona		1.6	70		4A-F Cat. not Europe	4	1,1	BCPR5EY-11	4120		LPG 3
Corona (AT171,177,ST171)		1.6	70		4A-F	4	0,8	BCRE527Y	2074		
Corona (AT171,177,ST171)		1.6	72	90 - 92	4A-FE	4	1,1	BCPR6EIX-11	4919		LPG 3
Corona (AT171,177,ST171)		1.6	75	90 - 92	4A-FE	4	0,8	BCPR5EY	1266		LPG 3
Corona (AT220,221,ST220)		1.6	81	04.98 -	4A-FE	4	1,3	BKR6EP-13	2550		
Corona (AT190,ST191)		1.6		93 -	4A-FE	4	1,1	BKR5EYA-11	2526	39	LPG 1
Corona (ST210, AT210)		1.6		01.00 -	4A-FE	4	0,8	BKR6EYA	2249		LPG 1
Corona (AZT220)		1.6		01.02 -	3ZZ-FE	4	1,1	BKR5EYA-11	2526	39	LPG 1
Corona (ST220)		1.6		01.02 -	3ZZ-FE	4	1,1	BKR5EYA-11	2526	39	LPG 1
Corona (ZZT220, 221)		1.6		01.02 -	3ZZ-FE	4	1,1	BKR5EYA-11	2526	39	LPG 1
Corona (AT220,221,ST220)		1.8	81	01.98 -	7A-FE	4	1,3	BKR6EP-13	2550		
Corona		1.8			1S-I	4	1,1	BRE527Y-11	6029		
Corona (AZT220)		1.8		01.02 -	1ZZ-FE	4	1,1	BKR5EYA-11	2526	39	LPG 1
Corona (ST220)		1.8		01.02 -	1ZZ-FE	4	1,1	BKR5EYA-11	2526	39	LPG 1
Corona (ZZT220, 221)		1.8		01.02 -	1ZZ-FE	4	1,1	BKR5EYA-11	2526	39	LPG 1
Corona (AT171,177,ST171)		2.0	89	- 92	3S-FE Cat.	4	1,1	BCPR6EY-11	3720		LPG 3
Corona (AT220,221,ST220)		2.0	94	01.98 -	3S-FE	4		BKR6EKP-11	3452		
Corona (AT190,191,ST191)		2.0	98	93 -	3S-FE	4	1,1	BKR6EYA-11	4073		LPG 1
Corona (AT171,177,ST171)		2.0	116	92 -	3S-GE	4	0,8	BKR6EP-8	2215		LPG 1
Corona		2.0		- 92	2C	4	█	Y-146R	7492		
Corona (AT171,177,ST171)		2.0		- 92	3S-F	4	1,1	BCPR6EY-11	3720		LPG 3
Corona		2.0		93 -	2C	4	█	Y-703R	3782		
Corona (ST210, AT210)		2.0		01.00 -	3S-FE	4		BKR6EKB-11	3583		
Corona (AZT220)		2.0		01.02 -	3S-FE	4		BKR6EKB-11	3583		
Corona (ST220)		2.0		01.02 -	3S-FE	4		BKR6EKB-11	3583		
Corona (ZZT220, 221)		2.0		01.02 -	3S-FE	4		BKR6EKB-11	3583		
Corona		2.4			2L / 2L-T	4	█	Y-118R	2187		

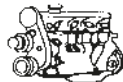
Code *l* kW

Cyl.



Stock-No.



LPG/CNG

**TOYOTA  
CROWN**

Crown			09.83 - 91	2L	4	☑	Y-118T1	2951		
Crown	2.0		93 -	1G-FE	4	0,8	BKR6EYA	2249		LPG 1
Crown (GS151)	2.0		98 -	1G-FE	4	1,1	BKR5EYA-11	2526	39	LPG 1
Crown (JZS155)	2.0		98 -	1G-FE	4	1,1	BKR5EYA-11	2526	39	LPG 1
Crown	2.5		93 -	2L	4	☑	Y-715R	5376		
Crown	2.8		86 -	5M-GE	6	0,8	BPR5EY	2828	9	LPG 2
Crown (GS151)	2.9		98 -	2JZ-GE with 3way cat.	6		BKR5EKB-11	3967		
Crown (GS151)	2.9		98 -	2JZ-GE without 3way cat.	6	0,8	BKR6EYA	2249		LPG 1
Crown (JZS155)	2.9		98 - 12.99	2JZ-GE with 3way cat.	6		BKR5EKB-11	3967		
Crown (JZS155)	2.9		98 -	2JZ-GE without 3way cat.	6	0,8	BKR6EYA	2249		LPG 1
Crown	3.0		93 - 12.99	2JZ-GE	6	0,8	BKR6EYA	2249		LPG 1
Crown (JZS155)	3.0		01.00 -	2JZ-GE	6		BKR5EKP-11	4302		

**DYNA**

Dyna (KDY220,230,250,260)	2.5	65	08.01 - 08.06	2KD-FTV	4	☑	Y-531J	5467	44	
Dyna (KDY220,230,250,260)	2.5	75	08.01 -	2KD-FTV	4	☑	Y-531J	5467	44	
Dyna 2500			93 -	2L	4	☑	Y-715R	5376		
Dyna 2800	2.8		93 -	3L	4	☑	Y-715R	5376		
Dyna 3000	3.0		90 - 91	B	4	☑	Y-178T	3030		
Dyna 3000	3.0		93 -	B / 11B	4	☑	Y-197T	2190		
Dyna 3000	3.0		93 -	B / 11B	4	☑	Y-147T	7493		
Dyna 3700			93 -	14B		☑	Y-197T	2190		
Dyna 3700			93 -	14B		☑	Y-147T	7493		

**ECHO**

Echo (SCP10,NCP10,11,12,13)	1.0		01.99 -	1SZ-FE	4	0,8	BKR5EYA	2087		LPG 1
Echo Verso (NCP20,21 ,22)	1.3	63	08.99 -	2NZ-FE	4	1,1	BKR5EYA-11	2526	39	LPG 1
Echo (NCP10,11,12,13, SCP10)	1.3		01.01 -	2NZ-FE	4	1,1	BKR5EYA-11	2526	39	LPG 1
Echo (NCP10,11,12,13, SCP10)	1.5	78	01.01 - 12.01	1NZ-FE	4	1,1	BKR5EYA-11	2526	39	LPG 1
Echo (NCP10,11,12,13, SCP10)	1.5	78	01.02 -	1NZ-FE	4	0,8	BKR5EYA	2087		LPG 1
Echo (NCP20, 21, 22)	1.5	78	01.02 -	1NZ-FE	4	0,8	BKR5EYA	2087		LPG 1
Echo NLP10	1.4	55	02 -	1ND-TV	4	☑	Y-542J	5513	45	
Echo Verso NLP20/22	1.4		02 -	1ND-TV	4	☑	Y-542J	5513	45	

**HIACE**

Hiace 3700			93 -	14B 12V		☑	Y-147T	7493		
Hiace 3700			93 -	14B 24V		☑	Y-197T	2190		
Hiace	1.8		95 -	2Y o.Cat.	4	0,8	BPR5EY	2828	9	LPG 2
Hiace (RZH102,103,104,109,112-115, 119,125)	2.0	74	90 - 98	1R-Z	4	0,8	BPR5EY	2828	9	LPG 2
Hiace (RZH102-105,112-115,125,135, 153,155)	2.0		98 -	1RZ	4	0,8	BP5EY	7327		LPG 2
Hiace (RZH102,103,104,109,112-115, 119,125)	2.4	88	90 -	2R-ZE	4	1,1	BPR5EP-11	3971		
Hiace	2.4		- 92	2L 12V	4	☑	Y-118R	2187		
Hiace	2.4		- 92	2L 24V	4	☑	Y-168R	2162		
Hiace	2.4		09.83 - 92	2L	4	☑	Y-118T1	2951		
Hiace Super Glow System	2.4		09.83 - 92	2L	4	☑	Y-118R	2187		
Hiace Super Glow System	2.4		09.83 - 92	2L	4	☑	Y-118R	2187		



Code *l* kW

Cyl.

Stock-No.  
**VEFINE**  
BY-PROMETRA

LPG/CNG

**TOYOTA****HIACE**

Hiace (RZH102,103,104,109,112-115,119,125)			2.4	90 -	2R-Z	4	0,8	BP5EY	7327		LPG 2
Hiace 2500 (LH102-104,112-115,125)			2.4	93 -	2L	4	▣	Y-715R	5376		
Hiace (RZH102-105,112-115,125,135,153,155)			2.4	98 -	2RZ	4	0,8	BP5EY	7327		LPG 2
Hiace (RZH102-105,112-115,125,135,153,155)			2.4	98 -	2RZ-E	4	1,1	BPR5EP-11	3971		
Hiace (RCH12,13,19,22,23,29)			2.4	01.00 -	2RZ-E	4	1,1	BPR5EP-11	3971		
Hiace (KLH12,KLH18,KLH22,KLH28)			2.5	65 08.01 - 08.06	2KD-FTV	4	▣	Y-531J	5467	44	
Hiace 2.5 D-4D (KLH12,KLH22)			2.5	70 09.06 -	2KD-FTV	4	▣	Y-531J	5467	44	
Hiace (KLH12,KLH18,KLH22,KLH28)			2.5	75 08.01 - 08.06	2KD-FTV	4	▣	Y-531J	5467	44	
Hiace 2.5 D-4D (KLH12,KLH22)			2.5	86 09.06 -	2KD-FTV	4	▣	Y-531J	5467	44	
Hiace (LH102-104,112-115,125)			2.5	98 -	2L	4	▣	Y-715R	5376		
Hiace (RCH12,13,19,22,23,29)			2.7	105 01.00 - 03	3RZ-FE	6	0,8	IFR5T-8N	3508		IFR5T-8N
Hiace (RCH 13,19,23,29)			2.7	01.04 -	3RZ-FE	4	1,1	IFR5T11	4996		IFR5T11
Hiace 2800			2.8	93 -	3L	4	▣	Y-715R	5376		
Hiace (LH102-104,112-115,125)			2.8	98 -	3L	4	▣	Y-715R	5376		
Hiace 3000			3.0	93 -	B / 11B 12V	4	▣	Y-147T	7493		
Hiace 3000			3.0	93 -	B / 11B 24V	4	▣	Y-197T	2190		

**HILUX**

Hilux				09.83 - 92	2L	4	▣	Y-118T1	2951		
Hilux Super Glow System				09.83 - 92	2L	4	▣	Y-118R	2187		
Hilux			1.8	61 88 - 94	2Y	4	0,8	BPR5EY	2828	9	LPG 2
Hilux			1.8		2Y-C	4	0,8	BPR5EY	2828	9	LPG 2
Hilux			1.8	95 -	2Y	4	0,8	BP5EY	7327		LPG 2
Hilux (TGN10,11,15,16,26,36)			2.0	100 07.05 -	1TR-FE	4	1,1	LFR6C-11	5788		
Hilux			2.0	88 - 94	3Y,3Y-C	4	0,8	BPR5EY	2828	9	LPG 2
Hilux			2.0	95 -	3Y	4	0,8	BP5EY	7327		LPG 2
Hilux(RZN142,144,147-149,154,168,169,173,174,193)			2.0	01.01 -	1RZ	4	0,8	BP5EY	7327		LPG 2
Hilux(RZN142,144,147-149,154,168,169,173,174,193)			2.0	01.01 -	1RZ-E	4	0,8	BPR5EY	2828	9	LPG 2
Hilux(VZN 167, 172)			2.0	01.01 -	1RZ	4	0,8	BP5EY	7327		LPG 2
Hilux			2.2	88 - 94	4Y,4Y-C	4	0,8	BPR5EY	2828	9	LPG 2
Hilux			2.2	95 -	4Y	4	0,8	BP5EY	7327		LPG 2
Hilux			2.4	84 88 -	22R-E Cat.	4	0,8	BPR5EY	2828	9	LPG 2
Hilux			2.4	- 92	2L 12V	4	▣	Y-118R	2187		
Hilux			2.4	- 92	2L 24V	4	▣	Y-168R	2162		
Hilux Super Glow System			2.4	09.83 - 92	2L	4	▣	Y-118R	2187		
Hilux			2.4	88 -	22R	4	0,8	BPR5EY	2828	9	LPG 2
Hilux 2500			2.4	93 -	2L	4	▣	Y-715R	5376		
Hilux (VZN 167, 172)			2.4	01.01 -	2RZ-FE	6	0,8	BKR5EYA	2087		LPG 1
Hilux(RZN142,144,147-149,154,168,169,173,174,193)			2.4	01.01 -	2RZ-FE	6	0,8	BKR5EYA	2087		LPG 1
Hilux 2.5 D-4D (KDN145,150,165,170,190)			2.5	65 08.01 - 08.05	2KD-FTV	4	▣	Y-531J	5467	44	
Hilux 2.5 D-4D (KUN15)			2.5	75 06.06 -	2KD-FTV	4	▣	Y-531J	5467	44	
Hilux 2.5 D-4D (KUN15)			2.5	88 06.06 -	2KD-FTV	4	▣	Y-531J	5467	44	
Hilux 2.5 D-4D (KUN25)			2.5	106 12.07 -	2KD-FTV	4	▣	Y-531J	5467	44	
Hilux (TNG10,11,15,16,26,36)			2.7	118 07.05 -	2TR-FE	4	1,1	LFR6C-11	5788		
Hilux			2.7	96 -	3RZ-FE	6	0,8	BKR5EYA	2087		LPG 1

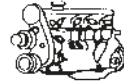
Code *l* kW

Cyl.

Stock-No.  
**V-LINE**  
10-14-19-20-21-22-23-24

LPG/CNG

**TOYOTA  
HILUX**

Hilux(RZN142,144,147-149,154,168,169,173,174,193)		2.7		01.01 -	3RZ-F	6	0,8	BKR5EYA	2087		LPG 1
Hilux(RZN142,144,147-149,154,168,169,173,174,193)		2.7		01.01 -	3RZ-FE	6	0,8	BKR5EYA	2087		LPG 1
Hilux 2800		2.8		93 -	3L	4	<input checked="" type="checkbox"/>	Y-715R	5376		
Hilux		3.0	105	89 -	3VZ-E	6	0,8	BKR5EYA	2087		LPG 1
Hilux 3.0 D-4D (KUN26)		3.0	126	08.05 -	1KD-FTV	4	<input checked="" type="checkbox"/>	Y-531J	5467	44	
Hilux		3.4		96 -	5VZ-FE	6		BKR5EKB-11	3967		
Hilux (GGN15,25)		4.0	175	07.05 -	1GR-FE	6	1,1	LFR6C-11	5788		
Hilux (GRN215W)		4.0		08.05 -	1GR-FE	6	1,1	LFR6C-11	5788		

**IQ**

iQ 1.0 VWT-i (KGJ10)		1.0	50	11.08 -	1KR-FE	3	1,1	ILFR5T11	96779		ILFR6T11
iQ 1.3 (NGJ10)		1.33	72	05.09 -	1NR-FE	4	1,1	ILKAR7B11	4912		ILKAR7B11
iQ 1.4 D-4D (NUJ10)		1.4	66	11.08 -	1ND-TV	4	<input checked="" type="checkbox"/>	Y-542J	5513	45	

**LAND CRUISER**

Land Cruiser					3B 4 Zyl., 2H 6Zyl.	6	<input checked="" type="checkbox"/>	Y-147T	7493		
Land Cruiser		2.4	77	- 12.96	22R-E	4	0,8	BPR5EY	2828	9	LPG 2
Land Cruiser (FJ62,70,73,75,RJ70)		2.4	77		22R	4	0,8	BPR5EY	2828	9	LPG 2
Land Cruiser		2.4			2L 2.4L	4	<input checked="" type="checkbox"/>	Y-118R	2187		
Land Cruiser (HZJ70,73,75)		2.5			2L-T	4	<input checked="" type="checkbox"/>	Y-715R	5376		
Land Cruiser		2.5		90 -	2L 2.5L	4	<input checked="" type="checkbox"/>	Y-715R	5376		
Land Cruiser		2.5		93 -	2L-T	4	<input checked="" type="checkbox"/>	Y-715R	5376		
Land Cruiser (RZJ90,95, VZJ90,95)		2.7		05.96 -	3RZ-F	6	0,8	BKR5EYA	2087		LPG 1
Land Cruiser (RZJ90,95, VZJ90,95)		2.7		05.96 -	3RZ-FE	6	0,8	BKR5EYA	2087		LPG 1
Land Cruiser (RZJ120,125)(GRJ120,125)		2.7		01.03 -	3RZ-FE with 3way cat.	4	1,1	BKR5EYA-11	2526	39	LPG 1
Land Cruiser (RZJ120,125)(GRJ120,125)		2.7		01.03 -	3RZ-FE without 3way cat.	4	0,8	BKR5EYA	2087		LPG 1
Land Cruiser (TRJ120,125)(GRJ120,125)		2.7		01.05 -	2TR-FE	6	1,1	ILFR6T11	4904		ILFR6T11
Land Cruiser		2.8		93 -	3L	4	<input checked="" type="checkbox"/>	Y-715R	5376		
Land Cruiser (KZJ90,95)		2.8		98 -	3L	4	<input checked="" type="checkbox"/>	Y-715R	5376		
Land Cruiser (LJ90,95)		2.8		98 -	3L	4	<input checked="" type="checkbox"/>	Y-715R	5376		
Land Cruiser (KZJ90,95)		3.0	92	98 -	1KZ-T	4	<input checked="" type="checkbox"/>	Y1013J	94470	63	
Land Cruiser (KZJ90,95)		3.0	92	98 -	1KZ-TE	4	<input checked="" type="checkbox"/>	Y1013J	94470	63	
Land Cruiser (LJ90,95)		3.0	92	98 -	1KZ-T	4	<input checked="" type="checkbox"/>	Y1013J	94470	63	
Land Cruiser (LJ90,95)		3.0	92	98 -	1KZ-TE	4	<input checked="" type="checkbox"/>	Y1013J	94470	63	
Land Cruiser D-4D (KDJ90,KDJ95,J9)		3.0	120	10.00 - 08.02	1KD-FTV	4	<input checked="" type="checkbox"/>	Y-531J	5467	44	
Land Cruiser 3.0 D-4D (KDJ 120, KDJ125,J12)		3.0	120	09.02 - 10.06	1KD-FTV	4	<input checked="" type="checkbox"/>	Y-531J	5467	44	
Land Cruiser 3.0 D-4D (KDJ125,J12)		3.0	122	08.04 - 10.06	1KD-FTV	4	<input checked="" type="checkbox"/>	Y-531J	5467	44	
Land Cruiser 3.0 D-4D (KDJ120, KDJ125,J12)		3.0	127	01.07 -	1KD-FTV	4	<input checked="" type="checkbox"/>	Y-531J	5467	44	
Land Cruiser 3.0 D-4D (KDJ 150,J15))		3.0	127	01.10 -	1KD-FTV	4	<input checked="" type="checkbox"/>	Y-531J	5467	44	
Land Cruiser 3.0 D-4D (KDJ 150, KDJ155,J15))		3.0	140	01.10 -	1KD-FTV	4	<input checked="" type="checkbox"/>	Y-531J	5467	44	
Land Cruiser (KZJ120)		3.0		09.02 -	1KD-FTV	4	<input checked="" type="checkbox"/>	Y-531J	5467	44	
Land Cruiser (LJ120,125)		3.0		09.02 -	1KD-FTV	4	<input checked="" type="checkbox"/>	Y-531J	5467	44	
Land Cruiser (RZJ90,95, VZJ90,95)		3.4	131	05.96 -	5VZ-FE	6		BKR5EKB-11	3967		
Land Cruiser (FJ62,70,73,75,RJ70)		4.0	107	88 -	3F	6	0,8	BPR4EY	2128		LPG 2
Land Cruiser (FJ62,70,73,75,RJ70)		4.0	115	01.90 - 08.92	3F-E Cat.	6	1,1	BPR5EY-11	3028		LPG 2
Land Cruiser (RZJ120,125)(GRJ120,125)		4.0	183	02 -	1GR-FE	6	1,1	LFR6C-11	5788		

Code *l* kW

Cyl.

Stock-No.  
**VEFINE**  
BY-PROMOTER

LPG/CNG

**TOYOTA****LAND CRUISER**

Land Cruiser (20W/121W)		4.0		08.05 -	1GR-FE	6	1,1	LFR6C-11	5788		
Land Cruiser (TRJ120, 125)(GRJ120, 125)		4.0		01.05 -	1GR-FE	6	1,1	LFR6C-11	5788		
Land Cruiser 150 (J15) 4.0 V6 VVTi		4.0	183	01.10 -	1GR-FE	6	1,1	ILFR6T11	4904		ILFR6T11
Land Cruiser 150 (J15) 4.0 V6 Dual VVTi		4.0	205	01.10 -	1GR-FE	6	1,1	ILFR6T11	4904		ILFR6T11
Land Cruiser 150 (J15) 4.0 V6 VVTi		4.0	207	01.10 -	1GR-FE	6	1,1	ILFR6T11	4904		ILFR6T11
Land Cruiser (HDJ100)		4.2		98 -	1HD-T	6	█	Y-532J	7782		
Land Cruiser (HZJ105)		4.2		98 -	1HD-T	6	█	Y-532J	7782		
Land Cruiser		4.5		93 -	1FZ-FE	6	0,8	BKR5EYA	2087		LPG 1
Land Cruiser (FZJ80)		4.5		96 -	1FZ-F	6	0,8	BKR5EYA	2087		LPG 1
Land Cruiser (FZJ100,105)		4.5		98 - 12.99	1FZ-FE	6		BKR5EKB-11	3967		
Land Cruiser (FZJ70,73,75)		4.5		98 - 12.99	1FZ-F	6	0,8	BKR5EYA	2087		LPG 1
Land Cruiser (FZJ70,73,75)		4.5		98 - 12.99	1FZ-FE	6	0,8	BKR5EYA	2087		LPG 1
Land Cruiser (UZJ100)		4.5		98 - 12.99	1FZ-FE	6		BKR5EKB-11	3967		
Land Cruiser (FZJ71,74,78,79)		4.5		01.00 -	1FZ-FE	6		BKR5EKB-11	3967		
Land Cruiser (UZJ100,FZJ100,105)		4.5		01.01 -	1FZ-FE	6		BKR5EKB-11	3967		
Land Cruiser (FZJ100,105)		4.5		01.02 -	1FZ-FE	6		BKR5EKB-11	3967		
Land Cruiser (UZJ100)		4.5		01.02 -	1FZ-FE	6		BKR5EKB-11	3967		
Land Cruiser (URJ202W)		4.6		09 -	1UR-FE	8	1,1	LFR6AIX-11	6619		
Land Cruiser 4.7 V8 (FZJ100,105)		4.7	173	01.98 -	2UZ-FE	8	1,1	IFR6T11	4589		IFR6T11
Land Cruiser 4.7 V8 (UZJ100)		4.7	173	01.98 -	2UZ-FE	8	1,1	IFR6T11	4589		IFR6T11
Land Cruiser 4.7 V8 (UZJ100,FZJ100,105)		4.7		01.01 -	2UZ-FE with 3way cat.	8	1,1	IFR6T11	4589		IFR6T11
Land Cruiser 4.7 V8 (UZJ200)		4.7	212	08.07 -	2UZ-FE	8	1,1	IFR6T11	4589		IFR6T11

**LITEACE**

Liteace		1.3	42		4K,4K-C	4	0,8	BPR5EA-L	5823		LPG 2
Liteace (KR41,42)		1.5		98 -	5K	4	0,8	BPR5EY	2828	9	LPG 2
Liteace (SR40)		1.5		98 -	5K	4	0,8	BPR5EY	2828	9	LPG 2
Liteace 2000		1.8			1C	4	█	Y-146R	7492		
Liteace (KM30,36,37, YM30,35,40,41)		1.8		89 -	2Y-C	4	0,8	BP5EY	7327		LPG 2
Liteace (KM30,36,37, YM30,35)		1.8		90 -	2Y Cat.	4	0,8	BP5EY	7327		LPG 2
Liteace (KM30,36,37, YM30,35)		1.8		90 -	2Y-C Cat.	4	1,1	BPR5EP-11	3971		
Liteace (KM30,36,37, YM30,35)		1.8		90 -	2Y-CU Cat.	4	0,8	BP5EY	7327		LPG 2
Liteace (KR41,42)		1.8		98 -	7K	4	0,8	BPR5EY	2828	9	LPG 2
Liteace (SR40)		1.8		98 -	7K	4	0,8	BPR5EY	2828	9	LPG 2
Liteace (KR42,SR40)		1.8		01.00 -	7K-E	4	1,1	BPR5EY-11	3028		LPG 2
Liteace (KM30,36,37, YM30,35,40,41)		2.0			3Y-CU	4	1,1	BPR5EP-11	3971		
Liteace 2000		2.0			2C	4	█	Y-703R	3782		
Liteace (KM30,36,37, YM30,35,40,41)		2.0		93 -	3Y	4	0,8	BP5EY	7327		LPG 2
Liteace (KR41,42)		2.0		98 -	3S-FE	4		BKR6EKB-11	3583		
Liteace (SR40)		2.0		98 -	3S-FE	4		BKR6EKB-11	3583		
Liteace		2.2		93 -	4Y-E	4	1,1	BPR5EP-11	3971		

**MODEL F**

Model F (YR21,22,31)		2.0	65		3Y-C	4	0,8	BPR5EY	2828	9	LPG 2
Model F		2.0			3Y-EC	4	0,8	BPR5EY	2828	9	LPG 2
Model F		2.2		90 -	4Y-E	4	0,8	BPR5EY	2828	9	LPG 2
Model F / Tarago		2.0			2C	4	█	Y-146R	7492		

**MR 2**

MR 2		1.6			4A-GZE	4	1,1	BCPR6EP-11	3350		LPG 3
MR 2 (ZZW30)		1.8	103	12.99 -	1ZZ-FE	4	1,1	BKR5EYA-11	2526	39	LPG 1
MR 2 (SW20)		2.0	115	90 - 93	3S-GE Cat.	4	0,8	BKR6EP-8	2215		LPG 1

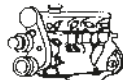
Code *l* kW

Cyl.



Stock-No.



LPG/CNG

**TOYOTA****MR 2**

MR 2 (SW20)		2.0	118	89 - 92	3S-GE	4	0,8	BKR6EYA	2249		LPG 1
MR 2 (SW20)		2.0	129	94 -	3S-GE	4	0,8	BKR6EP-8	2215		LPG 1
MR 2 (SW20)		2.0		93 -	3S-GTE	4	0,8	BKR6EP-8	2215		LPG 1
MR 2 (SW20)		2.2	89	90 -	3S-FE Cat.	4	1,1	BKR6EYA-11	4073		LPG 1
MR 2		2.2		93 -	5S-FE	4	1,1	BKR6EP-11	2978		LPG 1

**PASEO**

Paseo (EL54)		1.5	66	07.95 - 12.97	5E-FE (only Europe)	4	0,8	BKR5EYA	2087		LPG 1
Paseo (EL54)		1.5		01.98 - 07.99	5E-FE (only Europe)	4	1,1	BKR5EP-11	3440		LPG 1

**PICNIC**

Picnic (SXM10)		2.0	94	09.96 - 09.01	3S-FE	4		BKR6EKP-11	3452		
Picnic (ACM20)		2.0	110	05.01 -	1AZ-FE	4	1,1	IFR6T11	4589		IFR6T11
Picnic TD (CXM10)		2.2	66	98 -	3C-TE	4		Y1013J	94470	63	

**PREVIA**

Previa 2.0 D-4D (ACR3,CLR30)		2.0	85	03.01 - 12.05	1CD-FTV	4		Y-531J	5467	44	
Previa (TCR10,11,20,21)		2.4	97	05.90 - 00	2TZ-FE Cat.	4	1,1	BKR5EP-11	3440		LPG 1
Previa (TCR10,11,20,21)		2.4	97	05.90 -	2TZ-FE 3 way Cat.	4	0,8	BKR5EYA	2087		LPG 1
Previa (ACR30,50)		2.4	115	03.00 -	2AZ-FE	4	1,1	IFR6T11	4589		IFR6T11
Previa (TCR10,11,20,21)		2.4		96 -	2TZ-FE without Cat.	4	0,8	BKR5EYA	2087		LPG 1

**PRIUS**

Prius (Hybrid) (NHW11)		1.5	53	05.00 - 03	1NZ-FXE	4	1,1	IFR5T11	4996		IFR5T11
Prius (Hybrid) (NHW20)		1.5	57	03 - 09	1NZ-FXE	4	1,1	IFR5T11	4996		IFR5T11
Prius (ZVW30)		1.8	72	04.09 -	2ZR-FXE	4	1,1	ILKAR7B11	4912		ILKAR7B11

**PRIUS PLUS**

Prius Plus 1.8 Hybrid (ZVW40)		1.8	73	03.12 -	2ZR-FXE	4	1,1	ILKAR7B11	4912		ILKAR7B11
-------------------------------	--	-----	----	---------	---------	---	-----	-----------	------	--	-----------

**RAV 4**

RAV 4 (ZCA25,26,ACA20,21,22,23)		1.8	92	05.00 -	1ZZ-FE	4	1,1	BKR5EYA-11	2526	39	LPG 1
RAV 4 2.0 D		2.0	85	06.01 - 10.05	1CD-FTV	4		Y-531J	5467	44	
RAV 4 (SXA10,11)		2.0	95	06.94 - 09.97	3S-FE	4	1,1	BKR6EKB-11	3583		
RAV 4 (SXA10,11)		2.0	95	10.97 - 06.00	3S-FE	4		BKR6EKP-11	3452		
RAV 4 (ZSA30 / ZSA35)		2.0	116	12.08 -	3ZRFAE	4	1,1	ILKAR7B11	4912		ILKAR7B11
RAV 4 (ZCA25,26,ACA20,21,22,23)		2.0		05.00 -	1AZ-FE	4	1,1	IFR6T11	4589		IFR6T11
RAV 4 (ACA30, 33, 38)		2.0		11.05 - 01.07	1AZ-FE	4	1,1	IFR6T11	4589		IFR6T11
RAV 4 (ACA 30,31, 33,38)		2.0		01.07 -	1AZ-FE	4	1,1	IFR6T11	4589		IFR6T11
RAV 4 (ZCA25,26,ACA20,21,22,23)		2.4		01.04 -	2AZ-FE	4	1,1	IFR6T11	4589		IFR6T11
RAV 4 (ACA31, 33, 38)		2.4	125	11.05 -	2AZ-FE	4	1,1	IFR6T11	4589		IFR6T11
RAV 4 (ACA31W/36W)		2.4		11.05 -	2AZ-FE	4	1,1	IFR6T11	4589		IFR6T11
RAV 4 (ACA 30,31,33,38)		2.4		01.07 -	2AZ-FE	4	1,1	IFR6T11	4589		IFR6T11

**STARLET**

Starlet (EP70,EP71,EP76,EP80,EP81)		1.0	40	85 - 92	1E	4	0,8	BPR6EY	6427		LPG 2
Starlet (EP80,81)		1.3	53	88 - 92	2E	4	1,1	BPR5EY-11	3028		LPG 2
Starlet (EP80,81)		1.3	53	93 -	2E	4	0,8	BPR6EY	6427		LPG 2
Starlet (EP70,71,76)		1.3	55	88 -	2E-C	4	1,1	BPR6EY-11	4228	10	LPG 2
Starlet (EP80,81)		1.3	55	90 - 12.95	2E-E Cat.	4	0,8	BPR5EY	2828	9	LPG 2
Starlet		1.3	55	93 -	4A-FE	4	1,1	BKR5EYA-11	2526	39	LPG 1
Starlet (EP80,81)		1.3	55	02.96 - 03.97	4E-FE	4	0,8	BKR5EYA	2087		LPG 1
Starlet (EP90,91)		1.3	55	98 - 99	4E-FE	4	0,8	BKR5EYA	2087		LPG 1
Starlet		1.3		95 -	2E-E	4	0,8	BPR4EY	2128		LPG 2
Starlet (EP90,91)		1.3		98 -	2E	4	0,8	BPR6EY	6427		LPG 2
Starlet		1.5		90 - 92	1N	4		Y-715R	5376		

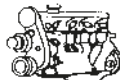
Code *l* kW

Cyl.



Stock-No.

**TOYOTA****STARLET**

Starlet		1.5		93 -	1N	4		Y-715R	5376		
---------	--	-----	--	------	----	---	--	--------	------	--	--

**SUPRA**

Supra		2.8			5M-GE	6	0,8	BPR6EY	6427		LPG 2
Supra (JZA80)		3.0	165	93 - 94	2JZ-GE	6	1,1	BKR5EP-11	3440		LPG 1
Supra Turbo (MA70)		3.0	175	87 - 92	7M-GTE	6	0,8	BCPR6EPN-8	5275		LPG 3
Supra V6 Biturbo (JZA80)		3.0	243	93 - 94	2JZ-GTE	6	1,1	BKR6EP-11	2978		LPG 1
Supra (MA70)		3.0		90 - 92	7M-GE	6	0,9	BCPR6EY	1146		LPG 3
Supra (JZA80)		3.0		95 - 95	2JZ-GE	6	1,1	BKR6EP-11	2978		LPG 1
Supra (JZA80)		3.0		95 -	2JZ-GTE	6	1,1	BKR6EP-11	2978		LPG 1
Supra (JZA80)		3.0		96 -	2JZ-GE	6	0,8	BKR6EYA	2249		LPG 1

**TARAGO**

Tarago		2.4	97	90 -	2TZ-FE	4	1,1	BKR5EP-11	3440		LPG 1
Tarago (ACR30)		2.4		03.00 -	2AZ-FE	4	1,1	IFR6T11	4589		IFR6T11

**TERCEL**

Tercel		1.3			2E	4	0,8	BPR6EY	6427		LPG 2
Tercel (EL50,53)		1.3		98 -	2E	4	0,8	BPR6EY	6427		LPG 2
Tercel (AL25)		1.5	50	88 -	3A-C Cat.	4	1,1	BPR5EY-11	3028		LPG 2
Tercel		1.5		93 -	3E-E	4	1,1	BPR5EY-11	3028		LPG 2
Tercel (EL50,53)		1.5		98 -	5E-FE	4		BKR5EKB-11	3967		

**TOWNACE**

Townace (KR41,42)		1.5		98 -	5K	4	0,8	BPR5EY	2828	9	LPG 2
Townace (SR40)		1.5		98 -	5K	4	0,8	BPR5EY	2828	9	LPG 2
Townace (KR41,42)		1.8		98 -	7K	4	0,8	BPR5EY	2828	9	LPG 2
Townace (SR40)		1.8		98 -	7K	4	0,8	BPR5EY	2828	9	LPG 2
Townace (KR42,SR40)		1.8		01.00 -	7K-E	4	1,1	BPR5EY-11	3028		LPG 2
Townace (KR41,42)		2.0		98 -	3S-FE	4		BKR6EKB-11	3583		
Townace (SR40)		2.0		98 -	3S-FE	4		BKR6EKB-11	3583		

**URBAN CRUISER**

Urban Cruiser 1.3 (NSP110)		1.33	73	04.10 -	1NR-FE	4	1,1	ILKAR7B11	4912		ILKAR7B11
Urban Cruiser 1.3 (NSP110)		1.33	74	01.09 -	1NR-FE	4	1,1	ILKAR7B11	4912		ILKAR7B11
Urban Cruiser 1.4 D-4D (NSP110)		1.4	66	01.09 -	1ND-TV	4		Y-542J	5513	45	

**VERSO**

Verso (ZGR20)		1.6	81	04.09 -	1ZRFAE	4	1,1	ILKAR7B11	4912		ILKAR7B11
Verso (ZGR20)		1.6	97	04.09 -	1ZRFAE	4	1,1	ILKAR7B11	4912		ILKAR7B11
Verso (ZGR21)		1.8	95	04.09 -	2ZRFAE	4	1,1	ILKAR7B11	4912		ILKAR7B11
Verso (ZGR21)		1.8	108	04.09 -	2ZRFAE	4	1,1	ILKAR7B11	4912		ILKAR7B11

**VERSO S**

Verso S 1.33 VVTi (NSP120)		1.33	73	11.10 -	1NR-FE	4	1,1	ILKAR7B11	4912		ILKAR7B11
----------------------------	--	------	----	---------	--------	---	-----	-----------	------	--	-----------

**YARIS**

Yaris 1.0 16V(NCP10,11,12,13)		1.0	48	01.99 -	1SZ-FE	4	0,8	BKR5EYA	2087		LPG 1
Yaris 1.0 16V(SCP10) Japan production		1.0	48	01.99 -	1SZ-FE	4	0,8	BKR5EYA	2087		LPG 1
Yaris 1.0 16V(SCP10) France production		1.0	48	01.01 -	1SZ-FE	4	1,1	BKR6EYA-11	4073		LPG 1
Yaris 1.0 (KSP90) VVTi		1.0	51	08.05 -	1KR-FE	3	1,1	LFR6C-11	5788		
Yaris 1.0 (NCP90,91) VVTi		1.0	51	08.05 -	1KR-FE	3	1,1	LFR6C-11	5788		
Yaris 1.0 (SCP90, NCP90; 91 ZSP90)		1.0		11.05 -	1KR-FE	3	1,1	LFR6C-11	5788		
Yaris 1.0 (KSP130) VVTi		1.0	51	09.11 -	1KR-FE	3	1,1	ILFR5T11	96779		ILFR6T11
Yaris 1.3 16V(NCP10,11,12,13)(SCP10		1.3	63	01.01 -	2NZ-FE	4	1,1	BKR5EYA-11	2526	39	LPG 1
Yaris 1.3 (NCP10,11,12,13)(SCP10,12)		1.3	64	04.02 -	2SZ-FE	4	0,8	BKR5EYA	2087		LPG 1

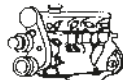

Code *l* kW

Cyl.



Stock-No.



LPG/CNG

**TOYOTA  
YARIS**

Yaris 1.3 (KSP90 )(ZSP90 ) VTI		1.3	64	08.05 - 11.06	2NZ-FE	4	1,1	BKR5EYA-11	2526	39	LPG 1
Yaris 1.3 (NCP90,91) VTI		1.3	64	08.05 - 11.06	2NZ-FE	4	1,1	BKR5EYA-11	2526	39	LPG 1
Yaris 1.3 (KSP90)(SCP90)		1.3		11.05 -	2SZ-FE	4	0,8	BKR5EYA	2087		LPG 1
Yaris 1.3 (NCP 92, 93)		1.3		01.06 -	2NZ-FE	4	1,1	BKR5EYA-11	2526	39	LPG 1
Yaris 1.3 (KSP130) VTI		1.33	73	09.11 -	1NR-FE	4	1,1	ILKAR7B11	4912		ILKAR7B11
Yaris 1.4 D-4D (NLP10)		1.4	55	12.01 -	1ND-TV	4		Y-542J	5513	45	
Yaris 1.4 (NLP90)		1.4	55	11.05 -	1ND-TV	4		Y-542J	5513	45	
Yaris 1.4 D-4D		1.4	66	02.06 -	1ND-TV	4		Y-542J	5513	45	
Yaris 1.5 (NCP10,11,12,13)(SCP10)		1.5	78	01.01 - 12.01	1NZ-FE	4	1,1	BKR5EYA-11	2526	39	LPG 1
Yaris 1.5 (NCP20, 21, 22)		1.5	78	01.02 -	1NZ-FE	4	0,8	BKR5EYA	2087		LPG 1
Yaris 1.5TS (NCP10,11,12,13)(SCP10)		1.5	78	01.02 -	1NZ-FE	4	0,8	BKR5EYA	2087		LPG 1
Yaris 1.5 (KSP90)(ZSP90)		1.5	78	08.05 - 11.06	1NZ-FE	4	0,8	BKR5EYA	2087		LPG 1
Yaris 1.5 (NCP90,91)		1.5	78	02.06 - 11.06	1NZ-FE	4	0,8	BKR5EYA	2087		LPG 1
Yaris 1.5 (NCP92, 93)		1.5		01.06 -	1NZ-FE	4	0,8	BKR5EYA	2087		LPG 1
Yaris TS (ZSP90)		1.8	97	11.06 -	2ZR-FE	4	1,1	ILKAR7B11	4912		ILKAR7B11
Yaris Verso ( NCP20,21,22 )		1.3	63	08.99 -	2NZ-FE	4	1,1	BKR5EYA-11	2526	39	LPG 1
Yaris Verso ( NCP20,21,22 )		1.5	78	01 - 12.00	1NZ-FE	4	1,1	BKR5EYA-11	2526	39	LPG 1

**TRABANT**

601		1.1	29	05.90 - 12.91	VW-Motor	4	0,7	BP6ES	7811	4	LPG 2
-----	--	-----	----	---------------	----------	---	-----	-------	------	---	-------

**TVR**

280 i		2.8				6	0,8	BPR6ES	7822	2	LPG 2
280 s		2.8				6	0,8	BPR6ES	7822	2	LPG 2
290 i		2.9				6	0,8	BPR6ES	7822	2	LPG 2
350 i		3.5				8	0,8	BPR6ES	7822	2	LPG 2
400		4.0				8	0,8	B7ECS	2528		
450		4.5				8	0,8	B7ECS	2528		
Cerbera		4.0		09.98 -	IL6 4.0L	6	0,9	DCPR8E	4339		LPG 8
Cerbera		4.2	306	95 -	AJP (TVR engine)	8		BKR5EKU	3964		
Chimaera		4.0			V8 Rover	8	0,8	B7ECS	2528		
Chimaera		4.3			V8 Rover	8	0,8	B7ECS	2528		
Chimaera		5.0			V8 Rover	8	0,8	B7ECS	2528		
Griffith		3.9				8	0,8	B7ECS	2528		
Griffith		4.3				8	0,8	B7ECS	2528		
Griffith		4.5				8	0,8	B7ECS	2528		
Griffith 500		5.0		95 -	V8 Rover	8	0,8	B7ECS	2528		
S2						6	0,8	BCPR6ES	2330	12	LPG 3
S3					non Cat.	6	0,8	BCPR6ES	2330	12	LPG 3
S3					With Cat.	6	1,0	BPR6EFS	3623	7	LPG 5
S3C		2.9				6	1,0	BPR6EFS	3623	7	LPG 5
Speed		3.9			39	8	0,8	B7ECS	2528		
Speed		4.3			43	8	0,8	B7ECS	2528		
Tamora		3.6			IL6	6	0,9	DCPR8E	4339		LPG 8
Tasmin		2.0				4	0,6	APR6FS	2922		
Tasmin		2.8				6	0,8	BCPR6ES	2330	12	LPG 3
Tuscan		3.5				8	0,9	BPR5ES	7422	6	LPG 2
Tuscan Speed Six		4.0		09.98 -		6	0,9	DCPR8E	4339		LPG 8

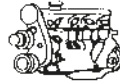
Code *l* kW

Cyl.



Stock-No.



LPG/CNG

**VOLVO****240**

240i	P242/P244/ P245	2.0	77	08.88 - 08.92		4	0,8	BPR6ES	7822	2	LPG 2
240i	P242/P244/ P245	2.0	86	08.87 - 07.92	B200E	4	0,8	BPR6ES	7822	2	LPG 2
240i	P242/P244/ P245	2.3	85	08.84 - 08.93	B230F Cat.	4	0,8	BPR6ES	7822	2	LPG 2
240i	P242/P244/ P245	2.3	96	08.87 - 07.92	B230E	4	0,8	BPR6ES	7822	2	LPG 2
240i	P242/P244/ P245	2.3		08.92 -	B230FD	4	0,8	BPR6ES	7822	2	LPG 2

**440**

440i	445	1.6	62	02.92 - 12.95	B16F Cat.	4	0,7	ZGR5B	7345		
440	445	1.7	58	09.88 - 12.96	B18K/B Cat.	4	0,8	BPR6ES	7822	2	LPG 2
440	445	1.7	58	09.89 - 12.91	B18KD Cat.	4	0,7	ZGR5B	7345		
440	445	1.7	64	09.88 - 02.92	B18KPD Cat.	4	0,7	ZGR5B	7345		
440i	445	1.7	70	09.88 - 03.92	B18F Cat.	4	0,7	ZGR5B	7345		
440i	445	1.7	75	09.89 - 12.96	B18FP Cat.	4	0,7	ZGR5B	7345		
440i	445	1.7	88	09.88 - 07.96	B18FTM/FT Cat.	4	0,8	BPR7ES	2023	19	BPR8EIX
440i	445	1.8	66	09.91 - 07.96	B18U Cat.	4	0,7	ZGR5B	7345		
440i	445	1.8	69	09.91 - 12.95	B18 u. Cat.	4	0,8	BPR6ES	7822	2	LPG 2
440 TD	445	1.9	66	01.93 - 12.96	Renault F8Q Turbo	4	█	Y-933J	7947	25	
440i	445	2.0	81	08.92 - 07.95	B20F Cat.	4	0,8	BPR7ES	2023	19	BPR8EIX
440i	445	2.0	81	09.92 -	B20U Cat.	4	0,8	BPR7ES	2023	19	BPR8EIX

**460**

460	464	1.7	64	01.90 - 09.91	B18KPD Cat.	4	0,7	ZGR5B	7345		
460 / 460i	464	1.7	66	03.90 - 12.95	B18KP/EP/ Cat	4	0,8	BPR6ES	7822	2	LPG 2
460i	464	1.7	75	01.90 - 09.92	B18FP Cat.	4	0,7	ZGR5B	7345		
460i	464	1.7	88	01.90 - 12.95	B18FT Cat.	4	0,8	BPR7ES	2023	19	BPR8EIX
460i	464	1.8	66	09.91 - 12.95	B18U Cat.	4	0,7	ZGR5B	7345		
460i	464	1.8	69	09.91 - 12.95	B18 u. Cat.	4	0,8	BPR6ES	7822	2	LPG 2
460 TD	464	1.9	66	06.94 - 08.97	D 19 T	4	█	Y-933J	7947	25	
460i	464	2.0	81	09.92 - 12.95	B20F Cat.	4	0,8	BPR7ES	2023	19	BPR8EIX

**480**

480i		1.7	75	10.89 - 09.92	B18FP Cat.	4	0,7	ZGR5B	7345		
480i		1.7	88	03.88 - 07.96	B18FT Cat.	4	0,8	BPR7ES	2023	19	BPR8EIX
480i		2.0	81	09.92 - 12.95	B20F Cat.	4	0,8	BPR7ES	2023	19	BPR8EIX

**740**

740i	744 / 745	2.0	76	08.83 - 07.91	B19E/B200E	4	0,8	BPR6ES	7822	2	LPG 2
740i 16V Italy	744 / 745	2.0	76	08.88 - 07.91	B204E	4	0,8	BPR6ES	7822	2	LPG 2
740i	744 / 745	2.0	82	08.89 - 07.91	B200F Cat.	4	0,8	BPR6ES	7822	2	LPG 2
740i Turbo	744 / 745	2.0	105	08.86 - 07.92	B200ET/FT Cat.	4	0,8	BPR6ES	7822	2	LPG 2
740i	744 / 745	2.3	85	08.87 - 07.95	B230F Cat.	4	0,8	BPR6ES	7822	2	LPG 2
740i	744 / 745	2.3	96	08.84 - 07.92	B230E/B230F Cat.	4	0,8	BPR6ES	7822	2	LPG 2
740i 16V	744 / 745	2.3	111	04.88 - 08.92	B234F Cat.	4	0,8	BPR6ES	7822	2	LPG 2
740i Turbo	744 / 745	2.3	114	08.86 - 07.91	B230FT Cat.	4	0,8	BPR6ES	7822	2	LPG 2
740 D	744 / 745	2.4	60	04.84 - 07.92	D 24	6	█	Y-918J	6285	2	
740 TD	744 / 745	2.4	80	04.87 - 07.92	D 24 T	6	█	Y-918J	6285	2	
740 TD (air condition)	744 / 745	2.4	85	08.87 - 07.92	D 24 TIC	6	█	Y-918J	6285	2	

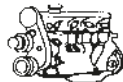
Code *l* kW

Cyl.



Stock-No.



LPG/CNG

**VOLVO****760**

760i Turbo	704/764/ 765	2.3	114	08.84 - 07.92	B230ET/FT Cat.	4	0,8	BPR6ES	7822	2	LPG 2
760 TD	704/764/ 765	2.4	85	08.87 - 07.92	D 24 TIC	6		Y-918J	6285	2	
760i	704/764/ 765	2.8	100	08.82 - 08.91	B28F/B280F Cat.	6	1,0	BPR6EFS	3623	7	LPG 5
760i / 780i	704/764/ 765	2.8	108	05.86 - 07.91	B280E	6	0,6	BP7EFS	3526		BP7EFVX

**780**

780 TD		2.4	85	08.85 -	D 24 TIC	6		Y-918J	6285	2	
780i		2.8	108	05.86 - 07.91	B280F Cat.	6	1,0	BPR6EFS	3623	7	LPG 5

**850**

850 2.0	LS / LW	2.0	93	08.94 - 12.96	B5202S	5		BKR6ETUC	3384		LPG 1
850 2.0	LS / LW	2.0	105	09.91 - 12.96	B5204F/B5204S	5		BKR6ETUC	3384		LPG 1
850 2.0 T	LS / LW	2.0	154	02.93 - 12.96	B5204T	5	0,8	BCPR6ES	2330	12	LPG 3
850 2.3 T5	LS / LW	2.3	166	04.94 - 12.96	B5234FT	5	0,6	BCP7EVX	7681		BCPR7EIX
850 2.3 T5 R	LS / LW	2.3	177	94 -	B5234T5	5	0,8	BKR7EVX	3544		BKR8EIX
850 2.3 T5 R	LS / LW	2.3	184	08.95 - 12.96	B5234T	5	0,8	BKR7EVX	3544		BKR8EIX
850 2.5 TDi	LS / LW	2.5	103		D5252 (Audi)	5		Y-732J	5605	4	
850 2.5	LS / LW	2.5	103	06.91 - 07.94	B5252	5		BKR6ETUC	3384		LPG 1
850 2.5	LS / LW	2.5	106	08.94 - 12.96	B5252S	5		BKR6ETUC	3384		LPG 1
850 2.5	LS / LW	2.5	125	09.91 - 12.96	B5254F	5		BKR6ETUC	3384		LPG 1
850 2.5 AWD	LS / LW	2.5	142	04.96 - 12.96	B5254T	5		PFR6B	3500		LPG 1

**940**

940i	944 / 945	2.0	82	09.90 - 07.94	B200E/B200F	4	0,8	BPR6ES	7822	2	LPG 2
940i Turbo	944 / 945	2.0	105	01.91 - 07.94	B200FT	4	0,8	BPR6ES	7822	2	LPG 2
940i	944 / 945	2.3	96	09.90 - 12.94	B230F	4	0,8	BPR6ES	7822	2	LPG 2
940i	944 / 945	2.3	96	08.90 - 12.94	B230FB	4	0,8	BPR6ES	7822	2	LPG 2
940	944 / 945	2.3	99	12.94 -	B230GK	4	0,8	BPR6ES	7822	2	LPG 2
940i 16V	944 / 945	2.3	114	09.90 - 07.91	B234F	4	0,8	BPR6ES	7822	2	LPG 2
940i Turbo Intercooler	944 / 945	2.3	121	08.90 - 07.94	B230FT	4	0,8	BPR6ES	7822	2	LPG 2
940i	944 / 945	2.3	126	08.94 - 10.98	B230FT / FK	4	0,8	BPR6ES	7822	2	LPG 2
940 TD	944 / 945	2.4	80	09.90 - 08.93	D 24 T	6		Y-918J	6285	2	
940 GL, GLE TD	944 / 945	2.4	85	09.90 -	D 24 TIC	6		Y-918J	6285	2	
940 TD Interc., Kombi	944 / 945	2.4	90	01.94 -	D 24 T	6		Y-918J	6285	2	

**960**

960i 16V Turbo Intercooler	964 / 965	2.0	140	09.90 -	B204FT	4	0,8	BPR6ES	7822	2	LPG 2
960i Turbo Intercooler	964 / 965	2.3	121	09.90 -	B230FT / FK	4	0,8	BPR6ES	7822	2	LPG 2
960 TD Intercooler	964 / 965	2.4	85	09.91 -	D 24 TIC	6		Y-918J	6285	2	
960	964 / 965	2.5	125	09.94 - 12.96	B6254F/G/S	6	0,8	BCPR6ES	2330	12	LPG 3
960i	964 / 965	2.8	110	09.90 - 08.91	B280F	6	1,0	BPR6EFS	3623	7	LPG 5
960i	964 / 965	2.8	125	09.90 -	B280E	6	0,6	BP7EFS	3526		BP7EFVX
960 2.9	964 / 965	2.9	150	09.90 - 07.94	B6304F	6	0,8	BCPR6ES	2330	12	LPG 3
960 2.9	964	2.9	150	07.94 - 12.96	B6304S	6		BKR6ETUC	3384		LPG 1
960	964 / 965	3.0	135	09.94 -	B6304F	6	0,8	BCPR6ES	2330	12	LPG 3
960	964 / 965	3.0	150	09.94 -	B6304F/G	6	0,8	BCPR6ES	2330	12	LPG 3

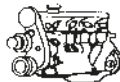
Code *l* kW

Cyl.



Stock-No.

V-TIME

E-FORWARD

LPG/CNG

**VOLVO****C 30**

C 30 1.6		1.6	74	11.06 -	B4164S3	4	1,3	TR5B-13	4559		LPG 4
C 30 1.6 D		1.6	80	11.06 -	D4164T	4	█	YE04	1684	40	
C 30 1.8		1.8	92	11.06 -	B4184S11	4	1,3	TR6AP-13	5809		LPG 5
C 30 1.8 Flexfuel		1.8	92	01.07 -	B4184S8	4	1,3	TR6AP-13	5809		LPG 5
C 30 2.0 D		2.0	100	11.06 -	D4204T	4	█	Y1005J	7957	56	
C 30 2.0		2.0	107	11.06 -	B4204S3	4	1,3	TR6AP-13	5809		LPG 5
C 30 2.0 Flexfuel		2.0	107	01.10 -	B4204S4	4	1,3	TR6AP-13	5809		LPG 5
C 30 D 5 to chassis no. 62745		2.4	120	11.06 - 07.10	D5244T9	5	█	Y8008AS	91440	74	
C 30 2.4		2.4	125	11.06 -	B5244S4	5		LFR6D	4704		LFR6D
C 30 D 5 to chassis no. 62745		2.4	132	11.06 - 07.10	D5244T8 / T13	5	█	Y8008AS	91440	74	
C 30 T 5		2.5	162	10.06 -	B5254T3	5	0,8	ILFR6B	6481		ILFR6B
C 30 T 5		2.5	169	03.07 -	B5254T7	5	0,8	ILFR6B	6481		ILFR6B

**C 70 1**

C 70 2.0 T		2.0	120	03.00 - 10.05	B5204T4	5	0,8	PFR6B	3500		LPG 1
C 70 2.0		2.0	132	03.97 - 10.05	B5204T2	5	0,8	BCPR7ES	3330		BCPR7EIX
C 70 2.0 T		2.0	166	01.97 - 10.05	B5204T3	5	0,8	BCPR7ES	3330		BCPR7EIX
C 70 2.3 T5		2.3	176	03.97 - 10.05	B5234T3	5	0,8	PFR6B	3500		LPG 1
C 70 2.3 T5		2.3	180	07.02 - 10.05	B5234T9	5	0,8	PFR6B	3500		LPG 1
C 70 2.4 T		2.4	142	08.99 - 10.05	B5244T	5	0,8	PFR6B	3500		LPG 1
C 70 2.4 T		2.4	147	07.02 - 10.05	B5244T7	5	0,8	PFR6B	3500		LPG 1
C 70 2.5		2.5	121	03.99 - 09.02	B5254S	5		BKR6ETUC	3384		LPG 1
C 70 2.5		2.5	125	11.99 - 10.05	B5244S	5		BKR6ETUC	3384		LPG 1
C 70 2.5 T		2.5	142	03.97 - 10.05	B5254T	5	0,8	PFR6B	3500		LPG 1

**C 70 2**

C 70 2.0 D		2.0	100	03.07 -	D4204T	4	█	Y1005J	7957	56	
C 70 2.4		2.4	103	03.06 -	B5244S5	5		LFR6D	4704		LFR6D
C 70 2.4		2.4	125	03.06 -	B5244S4	5		LFR6D	4704		LFR6D
C 70 D5 to chassis no. 49640		2.4	132	03.06 -	D5244T8 / T13	5	█	Y8008AS	91440	74	
C 70 T5		2.5	162	03.06 -	B5254T3	5	0,8	ILFR6B	6481		ILFR6B
C 70 T5		2.5	169	11.05 -	B5254T7	5	0,8	ILFR6B	6481		ILFR6B

**S 40 1**

S 40 1.6	VS	1.6	77	09.95 - 08.99	B4164S	4		BKR6ETUC	3384		LPG 1
S 40 1.6	VS	1.6	80	03.99 - 12.03	B4164S2	4		BKR6ETUC	3384		LPG 1
S 40 1.8	VS	1.8	85	07.95 - 08.99	B4184S	4		BKR6ETUC	3384		LPG 1
S 40 1.8 Bi-Fuel	VS	1.8	90	03.99 - 12.03	B4184S9	4		BKR6ETUC	3384		LPG 1
S 40 1.8	VS	1.8	90	03.99 - 12.03	B4184S2	4		BKR6ETUC	3384		LPG 1
S 40 1.8 GDI	VS	1.8	92	06.01 - 12.03	B4184SJ	4	0,6	IZFR6B	3116		IZFR6B
S 40 1.9D	VS	1.9	66	07.95 - 08.99	D4192T	4	█	Y-933J	7947	25	
S 40 1.9D	VS	1.9	75	07.00 - 12.03	D4192T4 / Di	4	█	Y-732J	5605	4	
S 40 1.9D	VS	1.9	85	07.00 - 12.03	D4192T3 / DI	4	█	Y-732J	5605	4	
S 40 T4	VS	1.9	147	05.97 - 07.00	B4194T / T2	4	0,8	PFR6G	4793		PFR7G
S 40 2.0	VS	2.0	100	07.95 - 12.03	B4204S/B4204S2	4		BKR6ETUC	3384		LPG 1
S 40 2.0	VS	2.0	103	07.95 - 08.99	B4204S	4		BKR6ETUC	3384		LPG 1
S 40 2.0 T	VS	2.0	120	10.97 - 12.03	B4204T3	4	0,8	PFR6B	3500		LPG 1
S 40 T4	VS	2.0	147	07.00 - 12.03	B4204T5	4	0,8	PFR6B	3500		LPG 1

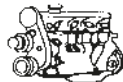
Code *l* kW

Cyl.



Stock-No.



LPG/CNG

**VOLVO****S 40 2**

S 40 II 1.6	MS	1.6	74	01.05 -	B4164S3	4	1,3	TR5B-13	4559		LPG 4
S 40 II 1.6 D to engine no. 16125	MS	1.6	81	01.05 - 12.11	D4164T	4	☑	YE04	1684	40	
S 40 II 1.6 D from engine no. 16126	MS	1.6	81	01.05 - 12.11	D4164T	4	☑	YE05	91322	73	
S 40 II 1.8	MS	1.8	92	04.04 - 09.10	B4184S11	4	1,3	TR6AP-13	5809		LPG 5
S 40 II 1.8 Flexfuel	MS	1.8	92	04.04 - 09.10	B4184S8	4	1,3	TR6AP-13	5809		LPG 5
S 40 II 2.0 D	MS	2.0	98	07.05 - 12.06	D4204T2	4	☑	Y1005J	7957	56	
S 40 II 2.0 D	MS	2.0	100	01.04 - 09.10	D4204T	4	☑	Y1005J	7957	56	
S 40 II 2.0	MS	2.0	107	10.06 -	B4204S3	4	1,3	TR6AP-13	5809		LPG 5
S 40 II 2.0 Flexfuel	MS	2.0	107	01.10 -	B4204S4	4	1,3	TR6AP-13	5809		LPG 5
S 40 II 2.4	MS	2.4	103	01.04 - 09.10	B5244S5	5		LFR6D	4704		LFR6D
S 40 II 2.4i	MS	2.4	125	01.04 - 09.10	B5244S4	5		LFR6D	4704		LFR6D
S 40 II 2.4 D5 to chassis no. 380303	MS	2.4	132	03.06 - 07.10	D5244T8	5	☑	Y8008AS	91440	74	
S 40 II T5	MS	2.5	162	01.04 - 05.08	B5254T3	5	0,8	ILFR6B	6481		ILFR6B
S 40 II T5	MS	2.5	169	03.07 -	B5254T7	5	0,8	ILFR6B	6481		ILFR6B

**S 60 1**

S 60 2.0 T		2.0	132	09.01 - 07.04	B5204T5	5	0,8	PFR6B	3500		LPG 1
S 60 2.0 T		2.0	132	08.04 - 03.10	B5204T5	5	0,8	ILFR6B	6481		ILFR6B
S 60 2.3 T		2.3	147	00 -	B5234T7	5	0,8	PFR6B	3500		LPG 1
S 60 T5		2.3	184	11.00 - 04.10	B5234T3	5	0,8	PFR6B	3500		LPG 1
S 60 2.4 D		2.4	93	09.05 - 03.10	D5244T7	5	☑	Y8008AS	91440	74	
S 60 2.4 D		2.4	96	12.01 -	D5244T2	5	☑	YE12	7794		
S 60 2.4		2.4	103	11.00 -	B5244S2	5		BKR6ETUC	3384		LPG 1
S 60 Bi-Fuel CNG (DK)		2.4	103	06.00 -	B5244SG	5		BKR6ETUC	3384		LPG 1
S 60 Bi-Fuel LPG		2.4	103	06.02 -	B5244SG2	5		BKR6ETUC	3384		LPG 1
S 60 2.4 D		2.4	120	07.01 -	D5244T	5	☑	YE12	7794		
S 60 2.4 D		2.4	120	01.07 - 03.10	D5244T5	5	☑	Y8008AS	91440	74	
S 60 2.4		2.4	125	11.00 -	B5244S	5		BKR6ETUC	3384		LPG 1
S 60 2.4 D5		2.4	136	09.05 - 03.10	D5244T4	5	☑	Y8008AS	91440	74	
S 60 2.4 T		2.4	147	11.00 -	B5244T3	5	0,8	PFR6B	3500		LPG 1
S 60 T5		2.4	191	04.04 -	B5244T5	5	0,8	ILFR6B	6481		ILFR6B
S 60		2.4		10.00 -	B5244T	5	0,8	PFR6B	3500		LPG 1
S 60 2.5T		2.5	154	02.04 - 04.10	B5254T2	5	0,8	PFR6B	3500		LPG 1
S 60 R 2.5T		2.5	220	03.03 -	B5254T4	5	0,8	ILFR6B	6481		ILFR6B

**S 60 2**

S 60 II T3		1.6	110	04.10 -	B4164T3	4	0,8	ILZTR6A8G	94769		
S 60 II T4		1.6	132	04.10 -	B4164T	4	0,8	ILZTR6A8G	94769		
S 60 II T4F Flexfuel		1.6	132	04.11 -	B4164T2	4	0,8	ILZTR6A8G	94769		
S 60 II D3		2.0	120	04.10 -	D5204T2 / T3	5	☑	Y8008AS	91440	74	
S 60 II D5		2.4	151	04.10 - 07.11	D5244T10	5	☑	Y8008AS	91440	74	
S 60 II D5		2.4	158	06.11 -	D5244T11 / T15	5	☑	Y8008AS	91440	74	

**S 70**

S 70 2.0	P80	2.0	93	01.97 - 11.00	B5202S	5		BKR6ETUC	3384		LPG 1
S 70 2.0	P80	2.0	105	01.97 - 11.00	B5204F	5		BKR6ETUC	3384		LPG 1
S 70 2.0	P80	2.0	120	01.97 - 11.00	B5204T4	5	0,8	PFR6B	3500		LPG 1
S 70 2.0	P80	2.0	132	01.97 - 11.00	B5204T2	5	0,8	BCPR7ES	3330		BCPR7EIX
S 70 2.0 Turbo	P80	2.0	154	01.97 - 11.00	B5204T	5	0,8	BCPR7ES	3330		BCPR7EIX
S 70 2.0 Turbo	P80	2.0	166	01.97 - 11.00	B5204T3	5	0,8	BCPR7ES	3330		BCPR7EIX
S 70	P80	2.3	120	99 -	B5234S	5	0,8	BKR6ES	3783	28	LPG 1



Code *l* kW

Cyl.



Stock-No.



LPG/CNG

**VOLVO****S 70**

S 70	P80	2.3	166	09.97 -	B5234T	5	0,8	BCPR7ES	3330		BCPR7EIX
S 70	P80	2.3	177	99 -	B5234T5	5	0,8	BCPR7ES	3330		BCPR7EIX
S 70	P80	2.3	177	99 -	B5234T6	5	0,8	BCPR7ES	3330		BCPR7EIX
S 70	P80	2.3	184	01.97 - 11.00	B5234T3	5	0,8	BKR7EVX	3544		BKR8EIX
S 70	P80	2.3	184	01.97 - 11.00	B5234T4	5	0,9	BKR7E	6097		BKR8EIX
S 70	P80	2.3	184	01.97 - 11.00	B5234T8	5	0,9	BKR7E	6097		BKR8EIX
S 70 2.4	P80	2.4	103	08.99 - 11.00	B5244S2	5		BKR6ETUC	3384		LPG 1
S 70 2.4 Blu-Fuel	P80	2.4	103	07.97 - 09.00	B5244S2/B5244SG	5		BKR6ETUC	3384		LPG 1
S 70 2.4	P80	2.4	125	01.97 - 11.00	B5244S	5		BKR6ETUC	3384		LPG 1
S 70 2.4 T	P80	2.4	142	01.97 - 11.00	B5244T	5	0,8	PFR6B	3500		LPG 1
S 70	P80	2.4	195	99 -	B5244T2	5	0,8	BCPR7ES	3330		BCPR7EIX
S 70 2.5 BiFuel	P80	2.5	103	07.99 - 11.00	B5244SG	5		BKR6ETUC	3384		LPG 1
S 70 2.5 TDi	P80	2.5	103	01.97 -	D5252 (Audi)	5	■	Y-732J	5605	4	
S 70 2.5 10V	P80	2.5	106	01.97 - 11.00	B5252S	5		BKR6ETUC	3384		LPG 1
S 70 2.5 BiFuel	P80	2.5	106	10.98 - 11.00	GB5252S	5		BKR6ETUC	3384		LPG 1
S 70 2.5 20V	P80	2.5	121	06.98 - 11.00	B5254S	5		BKR6ETUC	3384		LPG 1
S 70 2.5 T5	P80	2.5	142	11.96 - 04.99	B5254T	5	0,8	PFR6B	3500		LPG 1

**S 80 1**

S 80 2.0 T	TS	2.0	132	12.99 - 12.04	B5204T5	5	0,8	PFR6B	3500		LPG 1
S 80 2.0 T	TS	2.0	132	01.05 - 07.06	B5204T5	5	0,8	ILFR6B	6481		ILFR6B
S 80 2.0 T	TS	2.0	166	06.98 - 07.06	B5204T3	5	0,8	BCPR7ES	3330		BCPR7EIX
S 80 2.3 T	TS	2.3	147	99 - 07.06	B5234T7	5	0,8	PFR6B	3500		LPG 1
S 80 2.4 D	TS	2.4	96	10.01 - 07.06	D5244T2	5	■	YE12	7794		
S 80 2.4	TS	2.4	103	01.99 - 07.06	B5244S2	5		BKR6ETUC	3384		LPG 1
S 80 2.4 Bi-Fuel CNG	TS	2.4	103	09.01 - 07.06	B5244SG	5		BKR6ETUC	3384		LPG 1
S 80 2.4 Bi-Fuel LPG	TS	2.4	103	09.01 - 07.06	B5244SG2	5		BKR6ETUC	3384		LPG 1
S 80 2.4 D	TS	2.4	120	08.01 - 07.06	D5244T	5	■	YE12	7794		
S 80 2.4	TS	2.4	125	05.98 - 07.06	B5244S	5		BKR6ETUC	3384		LPG 1
S 80 2.4	TS	2.4	147	08.00 - 09.03	B5244T3	5	0,8	PFR6B	3500		LPG 1
S 80 2.4 T	TS	2.4	147	06.00 - 07.06	B5244T3	5	0,8	PFR6B	3500		LPG 1
S 80 2.5 D	TS	2.5	103	01.99 - 07.06	D5252T	5	■	Y-732J	5605	4	
S 80 2.5 T AWD	TS	2.5	154	07.03 - 07.06	B5254T2	5	0,8	PFR6B	3500		LPG 1
S 80 2.8 T6	TS	2.8	200	05.98 - 07.06	B6284T	6	0,8	PFR6B	3500		LPG 1
S 80 2.9	TS	2.9	144	06.01 - 07.06	B6294S / S2	6		BKR6ETUC	3384		LPG 1
S 80 2.9	TS	2.9	147	03.99 - 07.06	B6294S	6		BKR6ETUC	3384		LPG 1
S 80 3.0	TS	3.0	147	05.98 - 07.06	B6304S3	6		BKR6ETUC	3384		LPG 1
S 80 3.0	TS	3.0	150	06.99 - 07.06	B6304S	6	0,8	BKR6ES	3783	28	LPG 1
S 80 3.0 T6	TS	3.0	200	06.01 - 07.06	B6294T	6	0,8	PFR6B	3500		LPG 1

**S 80 2**

S 80 II T4	AS	1.6	132	10.10 -	B4164T	4	0,8	ILZTR6A8G	94769		
S 80 II T4F Flexfuel	AS	1.6	132	05.11 -	B4164T2	4	0,8	ILZTR6A8G	94769		
S 80 II 2.0 D	AS	2.0	100	11.07 -	D4204T	4	■	Y1005J	7957	56	
S 80 II 2.0	AS	2.0	107	11.07 -	B4204S3	4	1,3	TR6AP-13	5809		LPG 5
S 80 II 2.0 Flexfuel	AS	2.0	107	01.08 -	B4204S4	4	1,3	TR6AP-13	5809		LPG 5
S 80 II D3	AS	2.0	120	01.10 -	D5204T2 / T3	5	■	Y8008AS	91440	74	
S 80 II 2.4 D	AS	2.4	120	03.06 - 03.11	D5244T5 / T19	5	■	Y8008AS	91440	74	
S 80 II D5	AS	2.4	136	03.06 - 05.09	D5244T4	5	■	Y8008AS	91440	74	
S 80 II 2.5 T	AS	2.5	147	11.07 -	B5254T6 / T8	5	0,8	ILFR6K8	94040		ILFR6K8
S 80 II 2.5 T FlexFuel	AS	2.5	170	01.10 -	B5254T11	5	0,8	ILFR6K8	94040		ILFR6K8
S 80 II T6 AWD	AS	3.0	210	05.07 - 03.10	B6304T2	6	0,8	ILFR6B	6481		ILFR6B

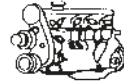
Code *l* kW

Cyl.



Stock-No.



LPG/CNG

**VOLVO****S 80 2**

S 80 II 3.2 S	AS	3.2	175	01.08 - 03.10	B6324S	6	0,8	ILFR6B	6481		ILFR6B
---------------	----	-----	-----	---------------	--------	---	-----	--------	------	--	--------

**S 90**

S 90		2.4	120	97 -	B6244F	6	0,8	BCPR6ES	2330	12	LPG 3
S 90		2.5	125	97 -	B6254F	6	0,8	BCPR6ES	2330	12	LPG 3
S 90		2.5	125	97 -	B6254G	6	0,8	BCPR6ES	2330	12	LPG 3
S 90 3.0		3.0	132	01.97 - 05.98	B6304S	6	0,8	BKR6ES	3783	28	LPG 1
S 90		3.0	150	97 -	B6304F	6	0,8	BCPR6ES	2330	12	LPG 3
S 90		3.0	150	01.97 - 05.98	B6304G	6	0,8	BCPR6ES	2330	12	LPG 3
S 90 3.0		3.0	150	01.97 -	B6304S	6	0,8	BKR6ES	3783	28	LPG 1

**V 40 1**

V 40 1.6	VW	1.6	77	12.95 - 08.99	B4164S	4		BKR6ETUC	3384		LPG 1
V 40 1.6	VW	1.6	80	03.99 - 05.04	B4164S2	4		BKR6ETUC	3384		LPG 1
V 40 1.8	VW	1.8	85	07.95 - 08.99	B4184S	4		BKR6ETUC	3384		LPG 1
V 40 1.8 Bi-Fuel	VW	1.8	90	03.99 - 06.04	B4184S9	4		BKR6ETUC	3384		LPG 1
V 40 1.8	VW	1.8	90	03.99 - 06.04	B4184S2	4		BKR6ETUC	3384		LPG 1
V 40 1.8 GDI	VW	1.8	92	08.97 - 04.04	B4184SJ	4	0,6	IZFR6B	3116		IZFR6B
V 40 1.8 i	VW	1.8	92	04.98 - 09.00	B4184SM/SJ	4	0,8	IZFR6B	3116		
V 40 1.9 D	VW	1.9	66	02.96 - 06.04	D4192T	4	☑	Y-933J	7947	25	
V 40 1.9 DI	VW	1.9	70	03.99 - 07.00	D4192T2	4	☑	Y-740U	4818	22	
V 40 1.9 D	VW	1.9	75	07.00 - 06.04	D4192T4 / DI	4	☑	Y-732J	5605	4	
V 40 1.9 D	VW	1.9	85	07.00 - 06.04	D4192T3 / DI	4	☑	Y-732J	5605	4	
V 40 T4	VW	1.9	147	05.97 - 07.00	B4194T / T2	4	0,8	PFR6G	4793		PFR7G
V 40 1.9 DCI	VW	1.9		07.00 - 06.04	dCi Renault	4	☑	Y-732J	5605	4	
V 40 2.0	VW	2.0	100	07.95 - 06.04	B4204S/B4204S2	4		BKR6ETUC	3384		LPG 1
V 40 2.0	VW	2.0	103	07.95 - 08.99	B4204S	4		BKR6ETUC	3384		LPG 1
V 40 2.0 T	VW	2.0	120	06.00 - 04.04	B4204T3	4	0,8	PFR6B	3500		LPG 1
V 40 2.0 T4	VW	2.0	147	07.00 - 06.04	B4204T5	4	0,8	PFR6B	3500		LPG 1

**V 40 2**

V 40 II T3		1.6	110	03.12 -	B4164T3	4	0,8	ILZTR6A8G	94769		
V 40 II T4		1.6	132	03.12 -	B4164T	4	0,8	ILZTR6A8G	94769		

**V 50**

V 50 1.6	MW	1.6	74	01.05 -	B4164S3	4	1,3	TR5B-13	4559		LPG 4
V 50 1.6 D to chassis no. 16125	MW	1.6	80	01.05 -	D4164T	4	☑	YE04	1684	40	
V 50 1.6 D from chassis no. 16126	MW	1.6	80	01.05 -	D4164T	4	☑	YE05	91322	73	
V 50 1.8	MW	1.8	92	04.04 -	B4184S11	4	1,3	TR6AP-13	5809		LPG 5
V 50 1.8 Flexfuel	MW	1.8	92	01.05 -	B4184S8	4	1,3	TR6AP-13	5809		LPG 5
V 50 2.0 D	MW	2.0	98	07.05 - 12.06	D4204T2	4	☑	Y1005J	7957	56	
V 50 2.0 D	MW	2.0	100	04.04 - 09.10	D4204T	4	☑	Y1005J	7957	56	
V 50 2.0	MW	2.0	107	10.06 -	B4204S3	4	1,3	TR6AP-13	5809		LPG 5
V 50 2.0 Flexfuel	MW	2.0	107	01.10 -	B4204S4	4	1,3	TR6AP-13	5809		LPG 5
V 50 2.4	MW	2.4	103	04.04 -	B5244S5	5		LFR6D	4704		LFR6D
V 50 2.4 D to chassis no. 396178	MW	2.4	120	05.07 - 09.10	D5244T9	5	☑	Y8008AS	91440	74	
V 50 2.4i	MW	2.4	125	04.04 -	B5244S4	5		LFR6D	4704		LFR6D
V 50 2.4 D5 to chassis no. 396178	MW	2.4	132	03.06 -	D5244T8 / T13	5	☑	Y8008AS	91440	74	
V 50 T5	MW	2.5	162	04.04 -	B5254T3	5	0,8	ILFR6B	6481		ILFR6B
V 50 T5	MW	2.5	169	03.07 -	B5254T7	5	0,8	ILFR6B	6481		ILFR6B

**V 60**

V 60 T3		1.6	110	09.10 -	B4164T3	4	0,8	ILZTR6A8G	94769		
V 60 T4		1.6	132	09.10 -	B4164T	4	0,8	ILZTR6A8G	94769		
V 60 T4F Flexfuel		1.6	132	04.11 -	B4164T2	4	0,8	ILZTR6A8G	94769		

Code *l* kW

Cyl.



Stock-No.

LPG/CNG

**VOLVO****V 60**

V 60 D3		2.0	120	09.10 - 08.11	D5204T2 / T3	5	☑	Y8008AS	91440	74	
V 60 D5		2.4	151	09.10 -	D5244T10	5	☑	Y8008AS	91440	74	
V 60 2.4 D5		2.4	158	06.11 -	D5244T11 / T15	5	☑	Y8008AS	91440	74	

**V 70 1**

V 70 1 2.0	P80	2.0	93	01.97 - 03.00	B5202S	5	0,8	BKR6ES	3783	28	LPG 1
V 70 1 2.0	P80	2.0	105	01.97 - 03.00	B5204S	5	0,8	BKR6ES	3783	28	LPG 1
V 70 1 2.0 T	P80	2.0	120	01.97 - 08.00	B5204T4	5	0,8	BKR6EVX	3539		LPG 1
V 70 1 2.0 T	P80	2.0	132	01.97 - 03.00	B5204T2	5	0,8	BKR6EVX	3539		LPG 1
V 70 1 2.0 T	P80	2.0	155	01.97 - 03.00	B5204T	5	0,8	BCPR7ES	3330		BCPR7EIX
V 70 1 2.0 T	P80	2.0	166	01.97 - 03.00	B5204T3	5	0,8	BCPR7ES	3330		BCPR7EIX
V 70 1 2.3 T5	P80	2.3	176	99 - 03.00	B5234T5	5	0,8	BCPR7ES	3330		BCPR7EIX
V 70 1 2.3 T5	P80	2.3	176	99 - 03.00	B5234T6	5	0,8	BCPR7ES	3330		BCPR7EIX
V 70 1 2.3 T	P80	2.3	184	04.97 - 03.00	B5234T4	5	0,8	BKR6EVX	3539		LPG 1
V 70 1 2.3 T	P80	2.3	184	01.97 - 03.00	B5234T8	5	0,8	BKR6EVX	3539		LPG 1
V 70 1 2.3 T	P80	2.3	184	01.97 - 03.00	B5234T3	5	0,8	BKR7EVX	3544		BKR8EIX
V 70 1 2.4	P80	2.4	103	08.99 - 03.00	B5244S2	5	0,8	BKR6ES	3783	28	LPG 1
V 70 1 2.4 Bi-Fuel CNG	P80	2.4	103	08.99 - 03.00	B5244SG	5		LPG 1	1496		LPG 1
V 70 1 2.4 Bi-Fuel LPG	P80	2.4	103	08.99 - 03.00	B5244SG2	5		LPG 1	1496		LPG 1
V 70 1 2.4 T	P80	2.4	142	01.97 - 03.00	B5244T	5	0,8	BKR6EVX	3539		LPG 1
V 70 1 2.4 T	P80	2.4	195	03.99 - 03.00	B5244T2	5	0,8	BCPR7ES	3330		BCPR7EIX
V 70 1 2.5 D	P80	2.5	103	01.97 - 03.00	D5252T	5	☑	Y-732J	5605	4	
V 70 1 2.5 10V	P80	2.5	106	01.97 - 03.00	B5252S	5	0,8	BKR6ES	3783	28	LPG 1
V 70 2.5 BiFuel	P80	2.5	106	10.98 - 08.99	GB5252S	5					
V 70 1 2.5 20V	P80	2.5	125	01.97 - 05.00	B5254S	5	0,8	BKR6ES	3783	28	LPG 1
V 70 1 2.5 T	P80	2.5	142	01.97 - 03.00	B5254T	5	0,8	BKR6EVX	3539		LPG 1

**V 70 2**

V 70 II 2.0	P80	2.0	107	10.07 -	B4204S3	4	1,3	TR6AP-13	5809		LPG 5
V 70 II 2.0 Flexfuel	P80	2.0	107	01.08 -	B4204S4	4	1,3	TR6AP-13	5809		LPG 5
V 70 II 2.0 T	P80	2.0	132	07.01 - 08.07	B5204T5	5	0,8	PFR6B	3500		LPG 1
V 70 II 2.3 T5	P80	2.3	184	03.00 - 08.07	B5234T3	5	0,8	PFR6B	3500		LPG 1
V 70 II 2.4 D	P80	2.4	93	05.05 - 07.07	D5244T7	5	☑	Y8008AS	91440	74	
V 70 II 2.4 D	P80	2.4	96	12.01 -	D5244T2	5	☑	YE12	7794		
V 70 II 2.4 D5	P80	2.4	120	08.01 - 07.06	D5244T	5	☑	YE12	7794		
V 70 II 2.4 D5	P80	2.4	120	08.06 - 07.07	D5244T5	5	☑	Y8008AS	91440	74	
V 70 II 2.4	P80	2.4	125	03.00 -	B5244S	5	0,8	BKR6ETUC	3384		LPG 1
V 70 II 2.4 D5	P80	2.4	136	12.05 - 07.07	D5244T4	5	☑	Y8008AS	91440	74	
V 70 II 2.4 T	P80	2.4	147	03.00 - 08.07	B5244T3	5	0,8	PFR6B	3500		LPG 1
V 70 II 2.4 T5	P80	2.4	191	04.04 - 07.07	B5244T5	5	0,8	ILFR6B	6481		ILFR6B
V 70 II 2.5 T	P80	2.5	154	04.04 - 08.07	B5254T2	5	0,8	PFR6B	3500		LPG 1
V 70 II R 2.5 T AWD	P80	2.5	220	03.03 -	B5254T4	5	0,8	ILFR6B	6481		ILFR6B

**V 70 3**

V 70 III T4		1.6	132	10.10 -	B4164T	4	0,8	ILZTR6A8G	94769		
V 70 III T4F Flexfuel		1.6	132	05.11 -	B4164T2	4	0,8	ILZTR6A8G	94769		
V 70 III 2.0 D		2.0	100	08.07 - 12.10	D4204T	4	☑	Y1005J	7957	56	
V 70 III D3		2.0	120	03.10 -	D5204T2 / T3	5	☑	Y8008AS	91440	74	
V 70 III 2.4 D		2.4	120	08.07 -	D5244T5	5	☑	Y8008AS	91440	74	
V 70 III 2.4 D		2.4	129	05.09 -	D5244T14	5	☑	Y8008AS	91440	74	
V 70 III D5		2.4	136	08.07 -	D5244T4	5	☑	Y8008AS	91440	74	
V 70 III D5		2.4	158	06.11 -	D5244T11 / T15	5	☑	Y8008AS	91440	74	
V 70 III 2.5 T		2.5	147	08.07 -	B5254T6 / T8	5	0,8	ILFR6K8	94040		ILFR6K8

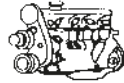
Code *l* kW

Cyl.



Stock-No.



LPG/CNG

**VOLVO****V 70 3**

V 70 III 2.5 T FlexFuel		2.5	170	10.09 -	B5254T11	5	0,8	ILFR6K8	94040		ILFR6K8
V 70 III T6 AWD		3.0	210	08.07 -	B6304T2	6	0,8	ILFR6B	6481		ILFR6B
V 70 III 3.2		3.2	175	08.07 -	B6324S	6	0,8	ILFR6B	6481		ILFR6B

**V 90**

V 90		2.4	120	97 -	B6244F	6	0,8	BCPR6ES	2330	12	LPG 3
V 90		2.5	125	97 -	B6254F	6	0,8	BCPR6ES	2330	12	LPG 3
V 90		2.5	125	97 -	B6254G	6	0,8	BCPR6ES	2330	12	LPG 3
V 90		2.9	150	97 -	B6304F	6	0,8	BCPR6ES	2330	12	LPG 3
V 90		2.9	150	97 -	B6304G	6	0,8	BCPR6ES	2330	12	LPG 3
V 90 3.0		3.0	132	01.97 -	B6304S2	6	0,8	BKR6ES	3783	28	LPG 1
V 90 3.0		3.0	150	01.97 -	B6304S	6	0,8	BKR6ES	3783	28	LPG 1

**XC60**

XC60 2.4 D only for EURO III and EURO IV		2.4	120	05.08 -	D5244T5 / T16	5		Y8008AS	91440	74	
XC60 D5 AWD only for EURO III and EURO IV		2.4	136	05.08 - 12.09	D5244T4	5		Y8008AS	91440	74	
XC60 3.0 T6 AWD		3.0	210	10.08 -	B6304T2	6	0,8	ILFR6B	6481		ILFR6B

**XC70 1**

XC70 2.4D5		2.4	120	09.02 -	D5244T5	5		YE12	7794		
XC70 2.4 D5 AWD		2.4	136	05.05 - 07.07	D5244T4	5		Y8008AS	91440	74	
XC70 2.4T		2.4	147	09.00 - 09.02	B5244T3	5	0,8	PFR6B	3500		LPG 1
XC70 2.5T		2.5	154	09.02 - 08.07	B5254T2	5	0,8	PFR6B	3500		LPG 1
XC70 3.0 T6 AWD		3.0	210	01.08 -	B6304T2	6	0,8	ILFR6B	6481		ILFR6B
XC70 3.2 AWD		3.2	175	02.07 -	B6324S	6	0,8	ILFR6B	6481		ILFR6B

**XC70 2**

XC70 II D3 AWD		2.0	120	08.11 -	D5204T2 / T3	5		Y8008AS	91440	74	
XC70 II 2.4 D AWD		2.4	120	08.07 -	D5244T5 / T16	5		Y8008AS	91440	74	
XC70 II 2.4 D		2.4	129	01.10 -	D5244T14	5		Y8008AS	91440	74	
XC70 II D5 AWD		2.4	136	08.07 -	D5244T4	5		Y8008AS	91440	74	
XC70 II D5 AWD		2.4	158	06.11 -	D5244T11 / T15	5		Y8008AS	91440	74	

**XC90**

XC90 D5		2.4	120	02.03 -	D5244T	5		YE12	7794		
XC90 2.5T		2.5	154	10.02 -	B5254T2	5	0,8	BKR6EVX	3539		LPG 1
XC90 T6 Biturbo		2.9	200	10.02 -	B6294T	6	0,8	BKR6EVX	3539		LPG 1
XC90 3.2		3.2	175	05.06 -	B6324S	6	0,8	ILFR6B	6481		ILFR6B
XC90 4.4		4.4	232	11.04 -	B8444S	8	1,1	IFR6B-11	5368		

**VW****AMAROK**

Amarok 2.0 TDI	2HA / 2HB	2.0	90	09.10 -	CDBA	4		Y1002AS	8888	57	
Amarok 2.0 TSI	2HA / 2HB	2.0	118	12.10 -	CFPA	4	0,8	PFR7S8EG	1675		PFR8S8EG
Amarok 2.0 BiTDI	2HA / 2HB	2.0	120	09.10 -	CDCA	4		Y1002AS	8888	57	
Amarok 2.0 BiTDI 4motion	2HA/2HB	2.0	132	11.11 -	CNEA	4		Y1002AS	8888	57	
Amarok 2.0 BiTDI 4motion	2HA/2HB	2.0	132	11.11 -	CSHA	4		Y1002AS	8888	57	

**BEETLE (NEW BEETLE)**

Beetle 1.4	9C1 / 1C1	1.4	55	08.01 -	BCA	4	1,1	PZFR5D-11	7968	34	LPG 6
Beetle 1.6	9C1 / 1C1	1.6	74	11.99 - 10.00	AWH	4		BKUR6ET-10	2397	24	LPG 1
Beetle 1.6	9C1 / 1C1	1.6	74	06.00 -	AYD	4		BKUR6ET-10	2397	24	LPG 1
Beetle 1.6	9C1 / 1C1	1.6	75	06.02 -	BFS	4		BKUR6ET-10	2397	24	LPG 1
Beetle 1.8 T	9C1 / 1C1	1.8	110	01.98 - 06.00	AGU	4	0,8	PFR6Q	6458	37	LPG 1

Code *l* kW

Cyl.

Stock-No.  
**VW**

LPG/CNG

**VW****BEETLE (NEW BEETLE)**

Beetle 1.8 T	9C1 / 1C1	1.8	110	01.99 - 06.00	APH	4	0,8	PFR6Q	6458	37	LPG 1
Beetle 1.8 T	9C1 / 1C1	1.8	110	07.99 - 10.00	AVC	4	0,8	PFR6Q	6458	37	LPG 1
Beetle 1.8 T	9C1 / 1C1	1.8	110	10.00 -	AWU	4	0,8	PFR6Q	6458	37	LPG 1
Beetle 1.8 T	9C1 / 1C1	1.8	110	06.00 - 06.04	AWV	4	0,8	PFR6Q	6458	37	LPG 1
Beetle 1.8 T	9C1 / 1C1	1.8	110	07.04 -	BKF	4	0,8	PFR6Q	6458	37	LPG 1
Beetle 1.8 T	9C1 / 1C1	1.8	132	06.02 - 06.04	AWP	4	0,8	PFR6Q	6458	37	LPG 1
Beetle 1.9 TDI	9C1 / 1C1	1.9	66	01.98 - 06.04	ALH	4	█	Y-732J	5605	4	
Beetle 1.9 TDI	9C1 / 1C1	1.9	74	10.00 -	ATD	4	█	Y-741U	6943	20	
Beetle 1.9 TDI	9C1 / 1C1	1.9	74	10.00 - 10.01	ATD	4	█	Y-732J	5605	4	
Beetle 1.9 TDI	9C1 / 1C1	1.9	74	06.03 -	AXR	4	█	Y-741U	6943	20	
Beetle 1.9 TDI	9C1 / 1C1	1.9	74	07.05 - 12.06	BEW	4	█	CZ104	9826	52	
Beetle 1.9 TDI	9C1 / 1C1	1.9	77	07.05 -	BSW	4	█	Y-741U	6943	20	
Beetle 2.0	9C1 / 1C1	2.0	85	01.98 - 05.01	AEG	4		BKUR6ET-10	2397	24	LPG 1
Beetle 2.0	9C1 / 1C1	2.0	85	08.98 -	AQY	4		BKUR6ET-10	2397	24	LPG 1
Beetle 2.0	9C1 / 1C1	2.0	85	03.00 -	APK	4		BKUR6ET-10	2397	24	LPG 1
Beetle 2.0	9C1 / 1C1	2.0	85	06.01 -	AZJ	4	1,1	PZFR5D-11	7968	34	LPG 6
Beetle 2.0	9C1 / 1C1	2.0	85	06.02 - 07.03	AZG	4	1,1	PZFR5D-11	7968	34	LPG 6
Beetle 2.0	9C1 / 1C1	2.0	85	01.03 -	BER	4	1,1	PZFR5D-11	7968	34	LPG 6
Beetle 2.0	9C1 / 1C1	2.0	85	07.04 -	BEV	4	1,1	PZFR5D-11	7968	34	LPG 6
Beetle 2.0	9C1 / 1C1	2.0	85	03.07 -	CBPA	4		BKUR6ET-10	2397	24	LPG 1
Beetle 2.0	9C1 / 1C1	2.0	85	07.05 -	BHP	4		BKUR6ET-10	2397	24	LPG 1
Beetle 2.3 V5	9C1 / 1C1	2.3	125	10.00 -	AQN	5	1,1	PZFR5D-11	7968	34	LPG 6
Beetle 2.5 Fgst → 1C-6-413 286*	9C1 / 1C1	2.5	110	07.05 -	BPR	5	1,1	PZFR5J-11	7743		LPG 6
Beetle 2.5 Fgst → 1C-6-413 286*	9C1 / 1C1	2.5	110	07.05 -	BPS	5	1,1	PZFR5J-11	7743		LPG 6
Beetle 3.2 RSI	9C1 / 1C1	3.2	165	10.00 - 05.01	AXJ	6	1,1	PZFR5D-11	7968	34	LPG 6

**BEETLE**

Beetle 2 1.2 TSI	5C1	1.2	77	10.11 -	CBZB	4	0,7	IZFR6P7	97153		IZFR6P7
Beetle 2 1.4 TSI	5C1	1.4	118	10.11 -	CAVD	4	0,8	PZFR6R8EG	96498		PZFR6R8EG
Beetle 2 1.4 TSI	5C1	1.4	118	10.11 -	CNWA	4	0,8	PZFR6R8EG	96498		PZFR6R8EG
Beetle 2 1.6 TDI	5C1	1.6	77	10.11 -	CAYC	4	█	Y1002AS	8888	57	
Beetle 2 2.0 TSI	5C1	2.0	147	10.11 -	CBFA	4	0,8	PFR7S8EG	1675		PFR8S8EG
Beetle 2 2.0 TSI	5C1	2.0	147	10.11 -	CCTA	4	0,8	PFR7S8EG	1675		PFR8S8EG

**BORA**

Bora 1.4	1J2 / 1J6	1.4	55	10.98 - 05.05	AHW	4		BKUR6ET-10	2397	24	LPG 1
Bora 1.4	1J2 / 1J6	1.4	55	05.00 - 10.01	AXP	4		BKUR6ET-10	2397	24	LPG 1
Bora 1.4	1J2 / 1J6	1.4	55	10.01 - 05.05	BCA	4		BKUR6ET-10	2397	24	LPG 1
Bora 1.4 16V	1J2 / 1J6	1.4	55	09.98 - 05.00	AKQ	4		BKUR6ET-10	2397	24	LPG 1
Bora 1.4 16V	1J2 / 1J6	1.4	55	05.99 - 05.00	APE	4		BKUR6ET-10	2397	24	LPG 1
Bora 1.4 Automatic	1J2 / 1J6	1.4	55	05.00 - 10.01	AXP	4	1,1	PZFR5D-11	7968	34	LPG 6
Bora 1.6 China	1J2 / 1J6	1.6	74	10.04 -	BJH	4	0,9	BKR6E	6962	28	LPG 1
Bora 1.6	1J2 / 1J6	1.6	74	09.98 - 06.02	AEH	4		BKUR6ET-10	2397	24	LPG 1
Bora 1.6	1J2 / 1J6	1.6	74	09.98 - 05.03	AKL	4		BKUR6ET-10	2397	24	LPG 1
Bora 1.6	1J2 / 1J6	1.6	74	05.99 - 09.00	APF	4		BKUR6ET-10	2397	24	LPG 1
Bora 1.6	1J2 / 1J6	1.6	74	09.00 - 04.02	AVU	4		BKUR6ET-10	2397	24	LPG 1
Bora 1.6	1J2 / 1J6	1.6	75	05.02 - 05.05	BFQ	4		BKUR6ET-10	2397	24	LPG 1
Bora 1.6 16V	1J2 / 1J6	1.6	77	11.99 - 05.00	ATN	4		BKUR6ET-10	2397	24	LPG 1
Bora 1.6 16V	1J2 / 1J6	1.6	77	05.00 - 10.00	AUS	4		BKUR6ET-10	2397	24	LPG 1
Bora 1.6 16V	1J2 / 1J6	1.6	77	11.01 - 05.05	BCB	4	1,1	PZFR6J-11	3586		LPG 6
Bora 1.6 16V	1J2 / 1J6	1.6	77	09.00 - 11.01	AZD	4	1,1	PZFR6J-11	3586		LPG 6
Bora 1.6 FSI	1J2 / 1J6	1.6	81	08.01 - 05.05	BAD	4		ZFR6S-Q	6449		ZFR6S-Q

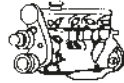

Code *l* kW

Cyl.

Stock-No.  
**V-FLINE**  
VW-POLYMER

LPG/CNG

**VW  
BORA**

Bora 1.8	1J2 / 1J6	1.8	92	09.98 - 10.00	AGN	4		BKUR6ET-10	2397	24	LPG 1
Bora 1.8 T	1J2 / 1J6	1.8	110	09.00 - 05.03	AGU	4	0,8	PFR6Q	6458	37	LPG 1
Bora 1.8 T	1J2 / 1J6	1.8	110	09.00 - 04.01	ARX	4	0,8	PFR6Q	6458	37	LPG 1
Bora 1.8 T	1J2 / 1J6	1.8	110	09.00 - 05.05	AUM	4	0,8	PFR6Q	6458	37	LPG 1
Bora 1.8 T	1J2 / 1J6	1.8	132	05.02 - 05.05	AUQ	4	0,8	PFR6Q	6458	37	LPG 1
Bora 1.9 SDI	1J2 / 1J6	1.9	50	11.98 - 05.05	AQM	4		Y-732J	5605	4	
Bora 1.9 SDI	1J2 / 1J6	1.9	50	05.00 - 04.01	AGP	4		Y-732J	5605	4	
Bora 1.9 TDI	1J2 / 1J6	1.9	66	10.98 - 09.02	AGR	4		Y-732J	5605	4	
Bora 1.9 TDI	1J2 / 1J6	1.9	66	09.98 - 05.03	ALH	4		Y-732J	5605	4	
Bora 1.9 TDI Fgst → 1J-2-600000	1J2 / 1J6	1.9	74	05.00 - 05.05	ATD	4		Y-732J	5605	4	
Bora 1.9 TDI Fgst → 1J-2-600000	1J2 / 1J6	1.9	74	05.01 - 05.05	AXR	4		Y-732J	5605	4	
Bora 1.9 TDI Fgst 1J-2-600001 →	1J2 / 1J6	1.9	74	05.00 - 05.05	ATD	4		Y-741U	6943	20	
Bora 1.9 TDI Fgst 1J-2-600001 →	1J2 / 1J6	1.9	74	05.01 - 05.05	AXR	4		Y-741U	6943	20	
Bora 1.9 TDI	1J2 / 1J6	1.9	81	09.98 - 05.05	AHF	4		Y-732J	5605	4	
Bora 1.9 TDI	1J2 / 1J6	1.9	81	05.00 - 05.05	ASV	4		Y-732J	5605	4	
Bora 1.9 TDI	1J2 / 1J6	1.9	85	11.98 - 07.01	AJM	4		Y-732J	5605	4	
Bora 1.9 TDI	1J2 / 1J6	1.9	85	05.00 - 07.01	AUY	4		Y-732J	5605	4	
Bora 1.9 TDI Fgst → 1J-2-600000	1J2 / 1J6	1.9	96	04.01 - 05.05	ASZ	4		Y-732J	5605	4	
Bora 1.9 TDI Fgst 1J-2-600001 →	1J2 / 1J6	1.9	96	04.01 - 05.05	ASZ	4		Y-741U	6943	20	
Bora 1.9 TDI Fgst → 1J-2-600000	1J2 / 1J6	1.9	110	09.00 - 05.05	ARL	4		Y-732J	5605	4	
Bora 1.9 TDI Fgst 1J-2-600001 →	1J2 / 1J6	1.9	110	09.00 - 05.05	ARL	4		Y-741U	6943	20	
Bora 2.0	1J2 / 1J6	2.0	85	11.98 - 05.05	APK	4		BKUR6ET-10	2397	24	LPG 1
Bora 2.0	1J2 / 1J6	2.0	85	09.98 - 05.05	AQY	4		BKUR6ET-10	2397	24	LPG 1
Bora 2.0	1J2 / 1J6	2.0	85	04.00 - 06.01	AZH	4		BKUR6ET-10	2397	24	LPG 1
Bora 2.0	1J2 / 1J6	2.0	85	05.01 - 05.05	AZJ	4	1,1	PZFR5D-11	7968	34	LPG 6
Bora 2.3 V5	1J2 / 1J6	2.3	110	09.98 - 02.01	AGZ	5		BKR5EKUP	2890		
Bora 2.3 V5	1J2 / 1J6	2.3	125	09.00 - 05.05	AQN	5	1,1	PZFR5D-11	7968	34	LPG 6
Bora 2.8 V6 4motion	1J2 / 1J6	2.8	150	05.01 - 05.03	BDE	6	1,1	PZFR5D-11	7968	34	LPG 6
Bora 2.8 V6 4motion	1J2 / 1J6	2.8	150	05.99 - 05.00	AQP	6	1,1	PZFR5D-11	7968	34	LPG 6
Bora 2.8 V6 4motion	1J2 / 1J6	2.8	150	05.00 - 04.01	AUE	6	1,1	PZFR5D-11	7968	34	LPG 6

**CADDY 1**

Caddy 1 1.6 D	14	1.6	40	08.90 - 07.92	ME	4		Y-918J	6285	2	
---------------	----	-----	----	---------------	----	---	--	--------	------	---	--

**CADDY 2**

Caddy 2 1.4	9K9A / 9K9B	1.4	44	11.95 - 12.97	AEX	4		BUR6ET	3172	1	LPG 2
Caddy 2 1.4	9K9A / 9K9B	1.4	44	11.97 - 09.00	AKV	4		BUR6ET	3172	1	LPG 2
Caddy 2 1.4	9K9A / 9K9B	1.4	44	12.97 - 06.03	APQ	4		BUR6ET	3172	1	LPG 2
Caddy 2 1.4	9K9A / 9K9B	1.4	44	09.00 - 06.03	AUD	4	1,1	PZFR5D-11	7968	34	LPG 6
Caddy 2 1.4	9K9A / 9K9B	1.4	55	09.00 - 06.03	AUA	4		BKUR6ET-10	2397	24	LPG 1
Caddy 2 1.6	9K9A / 9K9B	1.6	55	11.95 - 05.97	1F	4		BUR5ET	3377	22	LPG 2
Caddy 2 1.6	9K9A / 9K9B	1.6	55	06.96 - 12.00	AEE	4		BUR6ET	3172	1	LPG 2
Caddy 2 1.9 D	9K9A / 9K9B	1.9	47	11.95 - 06.03	1Y	4		Y-918J	6285	2	
Caddy 2 1.9 D	9K9A / 9K9B	1.9	47	06.96 - 12.00	AEF	4		Y-918J	6285	2	
Caddy 2 1.9 SDI	9K9A / 9K9B	1.9	47	11.95 - 09.00	AEY	4		Y-732J	5605	4	
Caddy 2 1.9 SDI	9K9A / 9K9B	1.9	47	09.00 - 06.03	AYQ	4		Y-732J	5605	4	
Caddy 2 1.9 TDI	9K9A / 9K9B	1.9	66	10.96 - 09.00	AHU	4		Y-732J	5605	4	
Caddy 2 1.9 TDI	9K9A / 9K9B	1.9	66	09.97 - 09.00	ALE	4		Y-732J	5605	4	
Caddy 2 1.9 TDI	9K9A / 9K9B	1.9	66	09.00 - 06.03	ALH	4		Y-732J	5605	4	

Fgst = Chassis No.

Code *l* kW

Cyl.

Stock-No.  
**VW**  
BY-POLWAZ

LPG/CNG

**VW****CADDY 3**

Caddy 3 1.2 TSI	2KB/2KJ/ 2KA/2KH	1.2	63	09.10 -	CBZA	4	0,7	IZFR6P7	97153		IZFR6P7
Caddy 3 1.2 TSI	2KB/2KJ/ 2KA/2KH	1.2	77	09.10 -	CBZB	4	0,7	IZFR6P7	97153		IZFR6P7
Caddy 3 1.4	2KB/2KJ/ 2KA/2KH	1.4	55	02.04 - 05.06	BCA	4		BKUR6ET-10	2397	24	LPG 1
Caddy 3 1.4	2KB/2KJ/ 2KA/2KH	1.4	59	05.06 -	BUD	4	1,1	ZFR6T-11G	5960		ZFR6T-11G
Caddy 3 1.6	2KB/2KJ/ 2KA/2KH	1.6	75	04.04 - 05.05	BGU	4		BKUR6ET-10	2397	24	LPG 1
Caddy 3 1.6	2KB/2KJ/ 2KA/2KH	1.6	75	06.05 -	BSE	4		BKUR6ET-10	2397	24	LPG 1
Caddy 3 1.6	2KB/2KJ/ 2KA/2KH	1.6	75	06.05 -	BSF	4		BKUR6ET-10	2397	24	LPG 1
Caddy 3 1.6 China	2KB/2KJ/ 2KA/2KH	1.6	74	05 -	BRY	4	0,9	BKR6E	6962	28	LPG 1
Caddy 3 1.6 TDI	2KB/2KJ/ 2KA/2KH	1.6	55	08.10 -	CAYE	4	■	Y1002AS	8888	57	
Caddy 3 1.6 TDI	2KB/2KJ/ 2KA/2KH	1.6	75	08.10 -	CAYD	4	■	Y1002AS	8888	57	
Caddy 3 1.9 TDI	2KB/2KJ/ 2KA/2KH	1.9	55	09.05 -	BSU	4	■	Y-607AS	7560	50	
Caddy 3 1.9 TDI	2KB/2KJ/ 2KA/2KH	1.9	77	02.04 -	BJB	4	■	Y-607AS	7560	50	
Caddy 3 1.9 TDI	2KB/2KJ/ 2KA/2KH	1.9	77	06.05 -	BLS	4	■	Y-607AS	7560	50	
Caddy 3 2.0 EcoFuel CNG	2KB/2KJ/ 2KA/2KH	2.0	80	04.06 -	BSX	4	0,9	BKR6E	6962	28	LPG 1
Caddy 3 2.0 SDI	2KB/2KJ/ 2KA/2KH	2.0	52	02.04 -	BDJ	4	■	Y-741U	6943	20	
Caddy 3 2.0 SDI	2KB/2KJ/ 2KA/2KH	2.0	52	06.05 -	BST	4	■	Y-741U	6943	20	
Caddy 3 2.0 TDI	2KB/2KJ/ 2KA/2KH	2.0	103	09.07 -	BMM	4	■	Y-607AS	7560	50	
Caddy 3 2.0 TDI	2KB/2KJ/2 KA/2KH	2.0	103	11.10 -	CFHC	4	■	Y1002AS	8888	57	
Caddy 3 2.0 TDI 4motion	2KB/2KJ/ 2KA/2KH	2.0	81	10.10 -	CFHF	4	■	Y1002AS	8888	57	

**CC**

CC 1.8 TSI	358	1.8	118	11.11 - 10.12	CDAA	4	0,8	PFR7S8EG	1675		PFR8S8EG
CC 2.0 TDI	358	2.0	100	11.11 -	CFFA	4	■	Y1002AS	8888	57	
CC 2.0 TDI	358	2.0	103	11.11 -	CFFB	4	■	Y1002AS	8888	57	
CC 2.0 TDI	358	2.0	125	11.11 -	CFGB	4	■	Y1002AS	8888	57	
CC 2.0 TDI	358	2.0	125	11.11 -	CLLA	4	■	Y1002AS	8888	57	
CC 2.0 TDI	358	2.0	130	12.12 -	CFGC	4	■	Y1002AS	8888	57	
CC 2.0 TSI	358	2.0	155	11.11 -	CCZB	4	0,8	PFR7S8EG	1675		PFR8S8EG
CC 3.6 FSI V6 4motion	358	3.6	220	11.11 -	BWS	6	0,8	ILZKR8A	94290		ILZKR8A

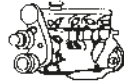
Code *ℓ* kW

Cyl.



Stock-No.



LPG/CNG

**VW  
CORRADO**

Corrado 1.8 16V	53I	1.8	98	04.89 - 07.92	KR	4		BCPR7ET	2164		BCPR7EIX
Corrado 2.0	53I	2.0	85	04.93 - 09.94	2E	4		BUR6ET	3172	1	LPG 2
Corrado 2.0	53I	2.0	85	07.94 - 07.95	ADY	4		BUR6ET	3172	1	LPG 2
Corrado 2.0 16V	53I	2.0	100	08.91 - 07.95	9A	4		BKUR7ET	7873		PFR7Q
Corrado 2.8 VR6	53I	2.8	128	08.91 - 01.96	AAA	6		BKR5EKUP	2890		
Corrado 2.8 VR6	53I	2.8	132	08.91 - 06.95	AAA	6		BKR5EKU	3964		
Corrado 2.8 VR6	53I	2.8	132	07.95 - 01.96	AAA	6		BKR5EKUP	2890		
Corrado 2.9 VR6	53I	2.9	140	08.91 - 07.95	ABV	6		BKR5EKU	3964		

**CRAFTER**

Crafter 2.5 TDI	2E/2F	2.0	80	05.11 -	CKTB	4	☑	Y1002AS	8888	57	
Crafter 2.5 TDI	2E/2F	2.0	100	05.11 -	CKTC	4	☑	Y1002AS	8888	57	
Crafter 2.5 TDI	2E/2F	2.0	105	10.11 -	CKUC	4	☑	Y1002AS	8888	57	
Crafter 2.5 TDI	2E/2F	2.0	120	07.11 -	CKUB	4	☑	Y1002AS	8888	57	
Crafter 2.5 TDI	2E/2F	2.5	65	04.06 - 07.11	BJJ	5	☑	Y-607AS	7560	50	
Crafter 2.5 TDI nur für Fzg. mit keramischer GK	2E/2F	2.5	65	04.06 - 07.11	BJJ	5	☑	CZ104	9826	52	
Crafter 2.5 TDI	2E/2F	2.5	65	05.09 - 07.11	CEBA	5	☑	Y-607AS	7560	50	
Crafter 2.5 TDI nur für Fzg. mit keramischer GK	2E/2F	2.5	65	05.09 - 07.11	CEBA	5	☑	CZ104	9826	52	
Crafter 2.5 TDI	2E/2F	2.5	80	04.06 - 07.11	BJK	5	☑	Y-607AS	7560	50	
Crafter 2.5 TDI nur für Fzg. mit keramischer GK	2E/2F	2.5	80	04.06 - 07.11	BJK	5	☑	CZ104	9826	52	
Crafter 2.5 TDI	2E/2F	2.5	80	05.09 - 07.11	CEBB	5	☑	Y-607AS	7560	50	
Crafter 2.5 TDI nur für Fzg. mit keramischer GK	2E/2F	2.5	80	05.09 - 07.11	CEBB	5	☑	CZ104	9826	52	
Crafter 2.5 TDI	2E/2F	2.5	100	04.06 -	BJL	5	☑	Y-607AS	7560	50	
Crafter 2.5 TDI nur für Fzg. mit keramischer GK	2E/2F	2.5	100	04.06 -	BJL	5	☑	CZ104	9826	52	
Crafter 2.5 TDI	2E/2F	2.5	100	05.09 -	CECA	5	☑	Y-607AS	7560	50	
Crafter 2.5 TDI nur für Fzg. mit keramischer GK	2E/2F	2.5	100	05.09 -	CECA	5	☑	CZ104	9826	52	
Crafter 2.5 TDI	2E/2F	2.5	120	04.06 - 07.11	BJM	5	☑	Y-607AS	7560	50	
Crafter 2.5 TDI nur für Fzg. mit keramischer GK	2E/2F	2.5	120	04.06 - 07.11	BJM	5	☑	CZ104	9826	52	
Crafter 2.5 TDI	2E/2F	2.5	120	05.09 - 07.11	CECB	5	☑	Y-607AS	7560	50	
Crafter 2.5 TDI nur für Fzg. mit keramischer GK	2E/2F	2.5	120	05.09 - 07.11	CECB	5	☑	CZ104	9826	52	

**EOS 1**

Eos 1.4 TSI	1F7	1.4	90	11.07 - 10.10	CAXA	4	0,9	PZFR6R	5758		PZFR6R
Eos 1.4 TSI	1F7	1.4	118	05.08 - 10.10	CAVD	4	0,9	PZFR6R	5758		PZFR6R
Eos 1.6 FSI	1F7	1.6	85	05.06 - 05.08	BLF	4		ZFR6S-Q	6449		ZFR6S-Q
Eos 2.0 FSI	1F7	2.0	110	05.06 - 05.08	BVY	4		PZFR5N-11T	7742		PZFR5N-11T
Eos 2.0 FSI	1F7	2.0	110	05.06 - 05.08	BVZ	4	0,9	BKR6E	6962	28	LPG 1
Eos 2.0 TDI	1F7	2.0	103	05.06 - 05.08	BMM	4	☑	Y-607AS	7560	50	
Eos 2.0 TDI	1F7	2.0	103	05.08 - 11.10	CBAB	4	☑	Y-609AS	5849	49	
Eos 2.0 TSI	1F7	2.0	147	05.06 - 11.10	BWA	4	0,8	PFR7S8EG	1675		PFR8S8EG
Eos 2.0 TSI	1F7	2.0	147	11.07 - 11.10	CCTA	4	0,8	PFR7S8EG	1675		PFR8S8EG
Eos 2.0 TSI	1F7	2.0	147	05.08 - 11.10	BPY	4	0,8	PFR7S8EG	1675		PFR8S8EG
Eos 2.0 TSI	1F7	2.0	147	05.08 - 11.10	CAWB	4	0,8	PFR7S8EG	1675		PFR8S8EG

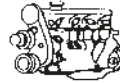
Code *l* kW

Cyl.



Stock-No.

VEMO  
LPG/CNG

VW

**EOS 1**

Eos 2.0 TSI	1F7	2.0	147	05.09 - 11.10	CCZA	4	0,8	PFR7S8EG	1675		PFR8S8EG
Eos 2.0 TSI	1F7	2.0	155	11.09 - 11.10	CCZB	4	0,8	PFR7S8EG	1675		PFR8S8EG
Eos 3.2 V6	1F7	3.2	184	05.06 - 05.09	BUB	6	0,9	IZKR7B	7563		IZKR7B
Eos 3.2 V6	1F7	3.2	184	05.06 - 05.09	CBRA	6	0,9	IZKR7B	7563		IZKR7B
Eos 3.6 V6	1F7	3.6	191	05.09 - 10.10	CDVA	6	0,9	ILZKR7A	1961		ILZKR7A

**EOS 2**

Eos 1.4 TSI	1F8	1.4	90	11.10 -	CAXA	4	0,9	PZFR6R	5758		PZFR6R
Eos 1.4 TSI	1F8	1.4	118	11.10 -	CAVD	4	0,8	PZFR6R8EG	96498		PZFR6R8EG
Eos 2.0 TDI	1F8	2.0	100	11.10 -	CFHB	4	█	Y1002AS	8888	57	
Eos 2.0 TDI	1F8	2.0	100	11.10 -	CFFA	4	█	Y1002AS	8888	57	
Eos 2.0 TDI	1F8	2.0	103	11.10 -	CFFB	4	█	Y1002AS	8888	57	
Eos 2.0 TDI	1F8	2.0	103	11.10 -	CFHC	4	█	Y1002AS	8888	57	
Eos 2.0 TSI	1F8	2.0	155	11.10 -	CCZB	4	0,8	PFR7S8EG	1675		PFR8S8EG

**FOX**

Fox 1.2	5Z1 / 5Z3	1.2	40	04.05 -	BMD	3	0,9	ZFR5P-G	6893		LPG 6
Fox 1.2	5Z1 / 5Z3	1.2	40	04.05 -	CHFB	3	1,1	ZFR6T-11G	5960		ZFR6T-11G
Fox 1.2	5Z1 / 5Z3	1.2	44	09.10 -	CHFA	3	1,1	ZFR6T-11G	5960		ZFR6T-11G
Fox 1.4	5Z1 / 5Z3	1.4	55	04.05 -	BKR	4	1,1	PZFR5D-11	7968	34	LPG 6
Fox 1.4 TDI	5Z1 / 5Z3	1.4	51	04.05 -	BNM	3	█	Y-741U	6943	20	

**GOLF 2**

Golf 2 1.0	19E / 1G1	1.0	37	08.89 - 10.91	HZ	4		BUR6ET	3172	1	LPG 2
Golf 2 1.3	19E / 1G1	1.3	40	01.89 - 07.92	2G	4		BUR6ET	3172	1	LPG 2
Golf 2 1.3	19E / 1G1	1.3	40	08.89 - 08.91	MH	4		BUR6ET	3172	1	LPG 2
Golf 2 1.3	19E / 1G1	1.3	40	08.89 - 07.92	NZ	4		BUR6ET	3172	1	LPG 2
Golf 2 1.6 D	19E / 1G1	1.6	40	01.84 - 10.91	JP	4	█	Y-918J	6285	2	
Golf 2 1.6 TD	19E / 1G1	1.6	44	08.89 - 07.92	1V	4	█	Y-918J	6285	2	
Golf 2 1.6	19E / 1G1	1.6	51	08.85 - 07.92	PN	4		BUR5ET-10	7264	21	LPG 2
Golf 2 1.6 TD	19E / 1G1	1.6	51	08.83 - 10.91	JR	4	█	Y-918J	6285	2	
Golf 2 1.6	19E / 1G1	1.6	53	07.91 - 07.92	ABX	4		BP5ET-10	5156		LPG 2
Golf 2 1.6	19E / 1G1	1.6	53	08.86 - 10.91	RF	4		BUR5ET-10	7264	21	LPG 2
Golf 2 1.6	19E / 1G1	1.6	55	08.83 - 07.92	EW	4		BUR5ET-10	7264	21	LPG 2
Golf 2 1.6	19E / 1G1	1.6	55	08.83 - 07.91	EZ	4		BUR5ET-10	7264	21	LPG 2
Golf 2 1.6	19E / 1G1	1.6	55	08.86 - 07.92	ABN	4		BUR5ET-10	7264	21	LPG 2
Golf 2 1.6 TD	19E / 1G1	1.6	59	04.89 - 10.91	RA	4	█	Y-918J	6285	2	
Golf 2 1.6 TD	19E / 1G1	1.6	59	08.89 - 10.91	SB	4	█	Y-918J	6285	2	
Golf 2 1.8	19E / 1G1	1.8	66	08.83 - 07.93	EX	4		BUR6ET	3172	1	LPG 2
Golf 2 1.8	19E / 1G1	1.8	66	08.83 - 10.91	GU	4		BUR6ET	3172	1	LPG 2
Golf 2 1.8	19E / 1G1	1.8	66	01.84 - 10.91	RP	4		BUR6ET	3172	1	LPG 2
Golf 2 1.8 Synchro	19E / 1G1	1.8	72	08.88 - 07.91	1P	4		BUR6ET	3172	1	LPG 2
Golf 2 1.8 Synchro	19E / 1G1	1.8	72	08.89 - 07.93	2H	4		BUR6ET	3172	1	LPG 2
Golf 2 1.8 GTI	19E / 1G1	1.8	77	08.87 - 10.91	RV	4		BUR6ET	3172	1	LPG 2
Golf 2 1.8 GTI	19E / 1G1	1.8	79	01.87 - 10.91	PF	4		BUR6ET	3172	1	LPG 2
Golf 2 1.8 GTI	19E / 1G1	1.8	82	01.87 - 10.91	PB	4		BUR6ET	3172	1	LPG 2
Golf 2 1.8 GTI 16V	19E / 1G1	1.8	95	02.86 - 10.91	PL	4		BKUR7ET	7873		PFR7Q
Golf 2 1.8 GTI 16V	19E / 1G1	1.8	102	02.86 - 10.91	KR	4		BCPR7ET	2164		BCPR7EIX
Golf 2 2.0 USA	19E / 1G1	2.0	100	07.89 - 07.92	9A	4		BKUR7ET	7873		PFR7Q

**GOLF 3**

Golf 3 1.4	1H1 / 1H5	1.4	44	11.91 - 07.95	ABD	4		BUR5ET	3377	22	LPG 2
Golf 3 1.4	1H1 / 1H5	1.4	44	07.95 - 12.97	AEX	4		BUR6ET	3172	1	LPG 2
Golf 3 1.6	1H1 / 1H5	1.6	55	08.92 - 09.94	ABU	4		BUR6ET	3172	1	LPG 2

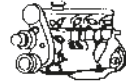
Code *ℓ* kW

Cyl.



Stock-No.



LPG/CNG

**VW  
GOLF 3**

Golf 3 1.6	1H1 / 1H5	1.6	55	10.94 - 07.95	AEA	4		BUR6ET	3172	1	LPG 2
Golf 3 1.6	1H1 / 1H5	1.6	55	07.95 - 12.97	AEE	4		BUR6ET	3172	1	LPG 2
Golf 3 1.6	1H1 / 1H5	1.6	74	10.94 - 12.95	AEK	4		BKUR5ET	2789	29	LPG 1
Golf 3 1.6	1H1 / 1H5	1.6	74	01.96 - 10.00	AFT	4		BKUR6ET-10	2397	24	LPG 1
Golf 3 1.6	1H1 / 1H5	1.6	74	04.97 - 10.00	AKS	4		BKUR5ET	2789	29	LPG 1
Golf 3 1.8	1H1 / 1H5	1.8	55	07.91 - 10.00	AAM	4		BUR5ET	3377	22	LPG 2
Golf 3 1.8	1H1 / 1H5	1.8	55	12.97 - 10.00	ANN	4		BUR5ET	3377	22	LPG 2
Golf 3 1.8	1H1 / 1H5	1.8	66	12.97 - 10.00	ANP	4		BUR6ET	3172	1	LPG 2
Golf 3 1.8	1H1 / 1H5	1.8	66	11.91 - 07.95	ABS	4		BUR6ET	3172	1	LPG 2
Golf 3 1.8	1H1 / 1H5	1.8	66	08.91 - 12.97	ACC	4		BUR6ET	3172	1	LPG 2
Golf 3 1.8	1H1 / 1H5	1.8	66	10.94 - 10.00	ADZ	4		BUR6ET	3172	1	LPG 2
Golf 3 1.8	1H1 / 1H5	1.8	66	01.98 -	ADD	4		BUR6ET	3172	1	LPG 2
Golf 3 1.9 SDI	1H1 / 1H5	1.9	47	07.95 - 02.99	AEY	4	☑	Y-732J	5605	4	
Golf 3 1.9 D	1H1 / 1H5	1.9	48	11.91 - 08.98	1Y	4	☑	Y-918J	6285	2	
Golf 3 1.9 TD	1H1 / 1H5	1.9	55	11.91 - 08.98	AAZ	4	☑	Y-918J	6285	2	
Golf 3 1.9 TDI	1H1 / 1H5	1.9	66	07.93 - 07.96	1Z	4	☑	Y-732J	5605	4	
Golf 3 1.9 TDI	1H1 / 1H5	1.9	66	07.96 - 06.00	AHU	4	☑	Y-732J	5605	4	
Golf 3 1.9 TDI	1H1 / 1H5	1.9	66	05.96 - 12.01	ALE	4	☑	Y-732J	5605	4	
Golf 3 1.9 TDI	1H1 / 1H5	1.9	81	02.96 - 08.99	AFN	4	☑	Y-732J	5605	4	
Golf 3 2.0 GUS	1H1 / 1H5	2.0	79	01.95 - 12.97	AEP	4		BUR6ET	3172	1	LPG 2
Golf 3 2.0 USA	1H1 / 1H5	2.0	85	03.92 - 07.95	ABA	4		BKR5EVX	2546		LPG 1
Golf 3 2.0	1H1 / 1H5	2.0	85	11.91 - 09.94	2E	4		BUR6ET	3172	1	LPG 2
Golf 3 2.0	1H1 / 1H5	2.0	85	10.94 - 05.96	ADY	4		BUR6ET	3172	1	LPG 2
Golf 3 2.0	1H1 / 1H5	2.0	85	07.95 - 12.01	AGG	4		BUR6ET	3172	1	LPG 2
Golf 3 2.0	1H1 / 1H5	2.0	85	04.97 - 04.00	AKR	4		BUR6ET	3172	1	LPG 2
Golf 3 2.0 USA	1H1 / 1H5	2.0	85	02.94 - 07.98	ADC	4		BKR5EVX	2546		LPG 1
Golf 3 2.0 GTI 16V	1H1 / 1H5	2.0	110	08.92 - 07.94	ABF	4		BKUR6ET-10	2397	24	LPG 1
Golf 3 2.8 VR6	1H1 / 1H5	2.8	128	01.92 - 06.95	AAA	6		BKR5EKU	3964		
Golf 3 2.8 VR6	1H1 / 1H5	2.8	128	07.95 - 12.97	AAA	6		BKR5EKUP	2890		
Golf 3 2.9 VR6 Synchro	1H1 / 1H5	2.9	140	10.94 - 12.97	ABV	6		BKR5EKU	3964		

**GOLF 4**

Golf 4 1.4	1J1 / 1J5	1.4	44	12.97 - 05.98	APQ	4		BUR6ET	3172	1	LPG 2
Golf 4 1.4	1J1 / 1J5	1.4	55	10.97 - 06.06	AHW	4		BKUR6ET-10	2397	24	LPG 1
Golf 4 1.4	1J1 / 1J5	1.4	55	10.97 - 05.00	AKQ	4		BKUR6ET-10	2397	24	LPG 1
Golf 4 1.4	1J1 / 1J5	1.4	55	05.99 - 05.00	APE	4		BKUR6ET-10	2397	24	LPG 1
Golf 4 1.4	1J1 / 1J5	1.4	55	10.01 - 06.06	BCA	4		BKUR6ET-10	2397	24	LPG 1
Golf 4 1.4 Automatic	1J1 / 1J5	1.4	55	05.00 - 10.01	AXP	4	1,1	PZFR5D-11	7968	34	LPG 6
Golf 4 1.4 Schaltgetriebe	1J1 / 1J5	1.4	55	05.00 - 10.01	AXP	4		BKUR6ET-10	2397	24	LPG 1
Golf 4 1.6 China	1J1 / 1J5	1.6	74	11.05 -	BJH	4	0,9	BKR6E	6962	28	LPG 1
Golf 4 1.6	1J1 / 1J5	1.6	74	10.97 - 05.03	AKL	4		BKUR6ET-10	2397	24	LPG 1
Golf 4 1.6	1J1 / 1J5	1.6	74	01.98 - 05.04	AEH	4		BKUR6ET-10	2397	24	LPG 1
Golf 4 1.6	1J1 / 1J5	1.6	74	05.99 - 08.00	APF	4		BKUR6ET-10	2397	24	LPG 1
Golf 4 1.6	1J1 / 1J5	1.6	74	09.00 - 04.02	AVU	4		BKUR6ET-10	2397	24	LPG 1
Golf 4 1.6	1J1 / 1J5	1.6	75	05.02 - 06.06	BFQ	4		BKUR6ET-10	2397	24	LPG 1
Golf 4 1.6	1J1 / 1J5	1.6	77	11.99 - 05.00	ATN	4		BKUR6ET-10	2397	24	LPG 1
Golf 4 1.6	1J1 / 1J5	1.6	77	05.00 - 10.00	AUS	4		BKUR6ET-10	2397	24	LPG 1
Golf 4 1.6	1J1 / 1J5	1.6	77	09.00 - 11.01	AZD	4	1,1	PZFR6J-11	3586		LPG 6
Golf 4 1.6	1J1 / 1J5	1.6	77	11.01 - 06.06	BCB	4	1,1	PZFR6J-11	3586		LPG 6
Golf 4 1.6 China	1J1 / 1J5	1.6	78	04 -	AWB	4	0,8	BKR5E	7938	35	LPG 1
Golf 4 1.6 FSI	1J1 / 1J5	1.6	81	08.01 - 06.06	BAD	4		ZFR6S-Q	6449		ZFR6S-Q



Code *l* kW

Cyl.

Stock-No.  
**VW**  
BY-PROMOTIONS

LPG/CNG

**VW****GOLF 4**

Golf 4 1.6 FSI	1J1 / 1J5	1.6	85	10.03 - 07.04	BAG	4		ZFR6S-Q	6449		ZFR6S-Q
Golf 4 1.8	1J1 / 1J5	1.8	92	07.98 - 10.00	AGN	4		BKUR6ET-10	2397	24	LPG 1
Golf 4 1.8 China	1J1 / 1J5	1.8	92	09.05 -	BAF	4		BKUR6ET-10	2397	24	LPG 1
Golf 4 1.8 T	1J1 / 1J5	1.8	110	05.99 - 04.01	ARZ	4	0,8	PFR6Q	6458	37	LPG 1
Golf 4 1.8 T	1J1 / 1J5	1.8	110	09.00 - 05.06	AUM	4	0,8	PFR6Q	6458	37	LPG 1
Golf 4 1.8 T USA	1J1 / 1J5	1.8	110	12.99 - 09.00	AWD	4	0,8	PFR6Q	6458	37	LPG 1
Golf 4 1.8 T GTI	1J1 / 1J5	1.8	110	10.97 - 05.03	AGU	4	0,8	PFR6Q	6458	37	LPG 1
Golf 4 1.8 T USA	1J1 / 1J5	1.8	110	08.00 -	AWW	4	0,8	PFR6Q	6458	37	LPG 1
Golf 4 1.8 T GTI	1J1 / 1J5	1.8	132	06.01 - 05.04	AUQ	4	0,8	PFR6Q	6458	37	LPG 1
Golf 4 1.9 SDI	1J1 / 1J5	1.9	50	10.97 - 04.01	AGP	4		Y-732J	5605	4	
Golf 4 1.9 SDI	1J1 / 1J5	1.9	50	11.98 - 05.06	AQM	4		Y-732J	5605	4	
Golf 4 1.9 TDI	1J1 / 1J5	1.9	66	10.97 - 09.02	AGR	4		Y-732J	5605	4	
Golf 4 1.9 TDI	1J1 / 1J5	1.9	66	10.97 - 05.03	ALH	4		Y-732J	5605	4	
Golf 4 1.9 TDI Fgst → 1J-2-600000	1J1 / 1J5	1.9	74	02.00 - 06.06	ATD	4		Y-732J	5605	4	
Golf 4 1.9 TDI Fgst → 1J-2-600000	1J1 / 1J5	1.9	74	05.01 - 06.06	AXR	4		Y-732J	5605	4	
Golf 4 1.9 TDI Fgst 1J-2-600001 →	1J1 / 1J5	1.9	74	02.00 - 06.06	ATD	4		Y-741U	6943	20	
Golf 4 1.9 TDI Fgst 1J-2-600001 →	1J1 / 1J5	1.9	74	05.01 - 06.06	AXR	4		Y-741U	6943	20	
Golf 4 1.9 TDI	1J1 / 1J5	1.9	81	10.97 - 05.06	AHF	4		Y-732J	5605	4	
Golf 4 1.9 TDI	1J1 / 1J5	1.9	81	08.99 - 10.00	AVG	4		Y-732J	5605	4	
Golf 4 1.9 TDI	1J1 / 1J5	1.9	81	05.00 - 05.06	ASV	4		Y-732J	5605	4	
Golf 4 1.9 TDI	1J1 / 1J5	1.9	85	05.99 - 07.01	AJM	4		Y-732J	5605	4	
Golf 4 1.9 TDI	1J1 / 1J5	1.9	85	01.00 - 07.01	AUY	4		Y-732J	5605	4	
Golf 4 1.9 TDI Fgst → 1J-2-600000	1J1 / 1J5	1.9	96	04.01 - 05.06	ASZ	4		Y-732J	5605	4	
Golf 4 1.9 TDI Fgst 1J-2-600001 →	1J1 / 1J5	1.9	96	04.01 - 05.06	ASZ	4		Y-741U	6943	20	
Golf 4 1.9 TDI Fgst → 1J-2-60 0000	1J1 / 1J5	1.9	110	09.00 - 05.06	ARL	4		Y-732J	5605	4	
Golf 4 1.9 TDI Fgst 1J-2-600001 →	1J1 / 1J5	1.9	110	09.00 - 05.06	ARL	4		Y-741U	6943	20	
Golf 4 2.0	1J1 / 1J5	2.0	85	08.98 - 05.03	APK	4		BKUR6ET-10	2397	24	LPG 1
Golf 4 2.0	1J1 / 1J5	2.0	85	08.98 - 06.06	AQY	4		BKUR6ET-10	2397	24	LPG 1
Golf 4 2.0	1J1 / 1J5	2.0	85	06.99 - 06.00	ATU	4	0,8	PFR6Q	6458	37	LPG 1
Golf 4 2.0	1J1 / 1J5	2.0	85	04.00 - 06.01	AZH	4		BKUR6ET-10	2397	24	LPG 1
Golf 4 2.0	1J1 / 1J5	2.0	85	05.01 - 04.02	AZG	4	1,1	PZFR5D-11	7968	34	LPG 6
Golf 4 2.0	1J1 / 1J5	2.0	85	05.01 - 06.06	AZJ	4	1,1	PZFR5D-11	7968	34	LPG 6
Golf 4 2.0	1J1 / 1J5	2.0	85	05.02 - 06.06	BEH	4	1,1	PZFR5D-11	7968	34	LPG 6
Golf 4 2.0 USA	1J1 / 1J5	2.0	85	06.98 -	AEG	4		BKUR6ET-10	2397	24	LPG 1
Golf 4 2.0 Cabrio	1J1 / 1J5	2.0	85	06.00 - 06.02	AWF	4	0,8	PFR6Q	6458	37	LPG 1
Golf 4 2.0 Cabrio	1J1 / 1J5	2.0	85	06.00 - 06.02	AWG	4	0,8	PFR6Q	6458	37	LPG 1
Golf 4 2.3 V5	1J1 / 1J5	2.3	110	10.97 - 02.01	AGZ	5		BKR5EKUP	2890		
Golf 4 2.3 V5	1J1 / 1J5	2.3	125	09.00 - 05.06	AQN	5	1,1	PZFR5D-11	7968	34	LPG 6
Golf 4 2.8 V6 USA	1J1 / 1J5	2.8	130	03.98 - 05.00	AFP	6		BKR5EKUP	2890		
Golf 4 2.8 V6	1J1 / 1J5	2.8	150	05.01 - 06.05	BDE	6	1,1	PZFR5D-11	7968	34	LPG 6
Golf 4 2.8 V6	1J1 / 1J5	2.8	150	05.99 - 05.00	AQP	6	1,1	PZFR5D-11	7968	34	LPG 6
Golf 4 2.8 V6	1J1 / 1J5	2.8	150	01.00 - 04.01	AUE	6	1,1	PZFR5D-11	7968	34	LPG 6
Golf 4 3.2 V6 R32	1J1 / 1J5	3.2	177	06.02 - 05.04	BFH	6	0,9	IZKR7B	7563		IZKR7B
Golf 4 3.2 V6 R32	1J1 / 1J5	3.2	177	11.03 - 06.06	BML	6	0,9	IZKR7B	7563		IZKR7B

**GOLF 5**

Golf 5 1.4	1K1 / 1K5	1.4	55	01.05 - 05.06	BCA	4		BKUR6ET-10	2397	24	LPG 1
Golf 5 1.4	1K1 / 1K5	1.4	59	05.06 - 11.08	BUD	4	1,1	ZFR6T-11G	5960		ZFR6T-11G
Golf 5 1.4 FSI	1K1 / 1K5	1.4	66	10.03 - 12.04	BKG	4		ZFR6S-Q	6449		ZFR6S-Q
Golf 5 1.4 FSI	1K1 / 1K5	1.4	66	11.04 - 07.06	BLN	4		ZFR6S-Q	6449		ZFR6S-Q
Golf 5 1.4 TSI	1K1 / 1K5	1.4	90	07.07 - 11.08	CAXA	4	0,9	PZFR6R	5758		PZFR6R

Fgst = Chassis No.

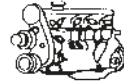
Code *ℓ* kW

Cyl.



Stock-No.



LPG/CNG

**VW  
GOLF 5**

Golf 5 1.4 TSI	1K1 / 1K5	1.4	103	05.06 - 05.07	BMV	4	0,9	PZFR6R	5758		PZFR6R
Golf 5 1.4 TSI GT	1K1 / 1K5	1.4	125	11.05 - 11.08	BLG	4	0,9	PZFR6R	5758		PZFR6R
Golf 5 1.6	1K1 / 1K5	1.6	75	01.04 - 06.05	BGU	4		BKUR6ET-10	2397	24	LPG 1
Golf 5 1.6	1K1 / 1K5	1.6	75	05.05 - 11.08	BSE	4		BKUR6ET-10	2397	24	LPG 1
Golf 5 1.6	1K1 / 1K5	1.6	75	05.05 - 11.08	BSF	4		BKUR6ET-10	2397	24	LPG 1
Golf 5 1.6	1K1 / 1K5	1.6	75	11.07 - 12.08	CCSA	4		BKUR6ET-10	2397	24	LPG 1
Golf 5 1.6 FSI	1K1 / 1K5	1.6	85	10.03 - 07.04	BAG	4		ZFR6S-Q	6449		ZFR6S-Q
Golf 5 1.6 FSI	1K1 / 1K5	1.6	85	05.04 - 07.05	BLP	4		ZFR6S-Q	6449		ZFR6S-Q
Golf 5 1.6 FSI	1K1 / 1K5	1.6	85	01.05 - 01.09	BLF	4		ZFR6S-Q	6449		ZFR6S-Q
Golf 5 1.9 TDI	1K1 / 1K5	1.9	66	05.04 - 02.06	BRU	4	▣	Y-607AS	7560	50	
Golf 5 1.9 TDI	1K1 / 1K5	1.9	66	02.06 - 01.09	BXF	4	▣	Y-607AS	7560	50	
Golf 5 1.9 TDI	1K1 / 1K5	1.9	66	05.07 - 01.09	BXJ	4	▣	Y-607AS	7560	50	
Golf 5 1.9 TDI	1K1 / 1K5	1.9	77	10.03 - 05.06	BKC	4	▣	Y-607AS	7560	50	
Golf 5 1.9 TDI	1K1 / 1K5	1.9	77	02.06 - 11.08	BXE	4	▣	Y-607AS	7560	50	
Golf 5 1.9 TDI only with DPF	1K1 / 1K5	1.9	77	06.05 - 05.07	BLS	4	▣	CZ104	9826	52	
Golf 5 1.9 TDI without DPF	1K1 / 1K5	1.9	77	06.05 - 05.07	BLS	4	▣	Y-607AS	7560	50	
Golf 5 2.0 SDI	1K1 / 1K5	2.0	55	01.04 - 05.07	BDK	4	▣	Y-607AS	7560	50	
Golf 5 2.0 TDI	1K1 / 1K5	2.0	100	10.03 - 05.07	AZV	4	▣	YE14	7768	48	
Golf 5 2.0 TDI	1K1 / 1K5	2.0	100	10.08 - 11.09	CBAA	4	▣	Y1002AS	8888	57	
Golf 5 2.0 TDI	1K1 / 1K5	2.0	100	07.08 - 11.08	CBDA	4	▣	Y1002AS	8888	57	
Golf 5 2.0 TDI	1K1 / 1K5	2.0	103	10.03 - 05.07	BKD	4	▣	YE14	7768	48	
Golf 5 2.0 TDI	1K1 / 1K5	2.0	103	12.04 - 11.08	BMM	4	▣	Y-607AS	7560	50	
Golf 5 2.0 TDI	1K1 / 1K5	2.0	103	02.08 -	CBDB	4	▣	Y1002AS	8888	57	
Golf 5 2.0 FSI	1K1 / 1K5	2.0	110	10.03 - 05.04	AXW	4		PZFR5N-11T	7742		PZFR5N-11T
Golf 5 2.0 FSI	1K1 / 1K5	2.0	110	05.04 - 07.07	BLX	4		PZFR5N-11T	7742		PZFR5N-11T
Golf 5 2.0 FSI	1K1 / 1K5	2.0	110	05.04 - 07.07	BLY	4	0,9	BKR6E	6962	28	LPG 1
Golf 5 2.0 FSI	1K1 / 1K5	2.0	110	01.05 - 07.07	BLR	4		PZFR5N-11T	7742		PZFR5N-11T
Golf 5 2.0 FSI	1K1 / 1K5	2.0	110	11.05 - 11.08	BVX	4		PZFR5N-11T	7742		PZFR5N-11T
Golf 5 2.0 FSI	1K1 / 1K5	2.0	110	05.05 - 11.08	BVY	4		PZFR5N-11T	7742		PZFR5N-11T
Golf 5 2.0 FSI	1K1 / 1K5	2.0	110	11.05 - 11.08	BVZ	4	0,9	BKR6E	6962	28	LPG 1
Golf 5 2.0 TDI	1K1 / 1K5	2.0	125	11.05 - 11.08	BMN	4	▣	CZ304	9864	55	
Golf 5 GTI	1K1 / 1K5	2.0	147	09.04 - 01.06	AXX	4	0,8	PFR7S8EG	1675		PFR8S8EG
Golf 5 GTI	1K1 / 1K5	2.0	147	11.05 - 02.09	BWA	4	0,8	PFR7S8EG	1675		PFR8S8EG
Golf 5 GTI	1K1 / 1K5	2.0	147	03.08 - 02.09	CAWB	4	0,8	PFR7S8EG	1675		PFR8S8EG
Golf 5 GTI	1K1 / 1K5	2.0	169	09.06 - 11.08	BYD	4	0,8	PFR7S8EG	1675		PFR8S8EG
Golf 5 R32	1K1 / 1K5	3.2	184	05.05 - 11.08	BUB	6	0,9	IZKR7B	7563		IZKR7B

**GOLF 6**

Golf 6 1.2 TSI	5K1 / AJ5	1.2	63	05.10 - 11.12	CBZA	4	0,7	IZFR6P7	97153		IZFR6P7
Golf 6 1.2 TSI	5K1 / AJ5	1.2	77	05.09 - 11.12	CBZB	4	0,7	IZFR6P7	97153		IZFR6P7
Golf 6 1.4	5K1 / AJ5	1.4	59	01.09 - 11.12	CGGA	4	1,1	ZFR6T-11G	5960		ZFR6T-11G
Golf 6 1.4 TSI	5K1 / AJ5	1.4	90	05.08 - 11.12	CAXA	4	0,9	PZFR6R	5758		PZFR6R
Golf 6 1.4 TSI	5K1 / AJ5	1.4	118	07.08 - 11.12	CAVD	4	0,8	PZFR6R8EG	96498		PZFR6R8EG
Golf 6 1.4 TSI	5K1 / AJ5	1.4	118	10.08 - 11.12	CNWA	4	0,8	PZFR6R8EG	96498		PZFR6R8EG
Golf 6 1.4 TSI	5K1 / AJ5	1.4	118	10.08 - 11.12	CTHD	4	0,8	PZFR6R8EG	96498		PZFR6R8EG
Golf 6 1.6	5K1 / AJ5	1.6	75	11.08 - 11.12	CCSA	4		BKUR6ET-10	2397	24	LPG 1
Golf 6 1.6 BiFuel (LPG)	5K1 / AJ5	1.6	75	03.09 - 11.12	CHGA	4		BKUR6ET-10	2397	24	LPG 1
Golf 6 1.6	5K1 / AJ5	1.6	75	05.10 - 11.12	CMXA	4		BKUR6ET-10	2397	24	LPG 1
Golf 6 1.6 TDI	5K1 / AJ5	1.6	66	12.08 - 11.12	CAYB	4	▣	Y1002AS	8888	57	
Golf 6 1.6 TDI	5K1 / AJ5	1.6	77	02.09 - 11.12	CAYC	4	▣	Y1002AS	8888	57	
Golf 6 1.8 TSI	5K1	1.8	118	06.09 - 01.11	CDA	4	0,8	PFR7S8EG	1675		PFR8S8EG

Code *l* kW

Cyl.

Stock-No.  
**VW**  
BY-POLYMER

LPG/CNG

**VW****GOLF 6**

Golf 6 2.0 TDI	5K1 / AJ5	2.0	81	10.08 - 11.12	CBDC	4	█	Y1002AS	8888	57	
Golf 6 2.0 TDI	5K1 / AJ5	2.0	100	10.08 - 11.12	CBAA	4	█	Y1002AS	8888	57	
Golf 6 2.0 TDI	5K1 / AJ5	2.0	100	10.08 - 11.12	CFFA	4	█	Y1002AS	8888	57	
Golf 6 2.0 TDI	5K1 / AJ5	2.0	103	10.08 - 11.12	CFFB	4	█	Y1002AS	8888	57	
Golf 6 2.0 TDI	5K1 / AJ5	2.0	103	10.08 - 11.12	CBAB	4	█	Y1002AS	8888	57	
Golf 6 2.0 TDI	AJ5	2.0	103	11.09 -	CFHC	4	█	Y1002AS	8888	57	
Golf 6 2.0 TDI GTD	5K1	2.0	125	04.09 - 11.09	CBBB	4	█	Y1002AS	8888	57	
Golf 6 2.0 TDI GTD	5K1	2.0	125	05.10 - 11.12	CFGB	4	█	Y1002AS	8888	57	
Golf 6 2.0 GTI	5K1	2.0	155	04.09 - 11.12	CCZB	4	0,8	PFR7S8EG	1675		PFR8S8EG
Golf 6 2.0 GTI	5K1	2.0	173	05.11 - 11.12	CDLG	4	0,8	PFR7S8EG	1675		PFR8S8EG
Golf 6 2.0 TSI R 4motion	5K1	2.0	188	11.09 - 11.12	CDLC	4	0,8	PFR7S8EG	1675		PFR8S8EG
Golf 6 2.0 TSI R 4motion	5K1	2.0	199	11.09 - 11.12	CDLF	4	0,8	PFR7S8EG	1675		PFR8S8EG

**GOLF 6 CABRIOLET**

Golf 6 Cabriolet 1.2 TSI	517	1.2	77	06.11 -	CBZB	4	0,7	IZFR6P7	97153		IZFR6P7
Golf 6 Cabriolet 1.4 TSI	517	1.4	90	06.11 -	CAXA	4	0,9	PZFR6R	5758		PZFR6R
Golf 6 Cabriolet 1.4 TSI	517	1.4	118	03.11 -	CAVD	4	0,8	PZFR6R8EG	96498		PZFR6R8EG
Golf 6 Cabriolet 1.6 TDI	517	1.6	77	06.11 -	CAYC	4	█	Y1002AS	8888	57	
Golf 6 Cabriolet 2.0 TDI	517	2.0	103	11.11 -	CFHC	4	█	Y1002AS	8888	57	
Golf 6 Cabriolet 2.0 TSI GTI	517	2.0	155	06.11 -	CCZB	4	0,8	PFR7S8EG	1675		PFR8S8EG

**GOLF 7**

Golf 7 1.6 TDI nur für Zylinder ohne Drucksensor	5G1	1.6	77	08.12 -	CLHA	4	█	Y1002AS	8888	57	
Golf 7 2.0 TDI nur für Zylinder ohne Drucksensor	5G1	2.0	110	08.12 -	CRBC	4	█	Y1002AS	8888	57	
Golf 7 2.0 TDI nur für Zylinder ohne Drucksensor	5G1	2.0	110	08.12 -	CRLB	4	█	Y1002AS	8888	57	

**GOLF PLUS**

Golf Plus 1.2 TSI	5M1	1.2	63	05.10 -	CBZA	4	0,7	IZFR6P7	97153		IZFR6P7
Golf Plus 1.2 TSI	5M1	1.2	77	11.09 -	CBZB	4	0,7	IZFR6P7	97153		IZFR6P7
Golf Plus 1.4	5M1	1.4	55	01.05 - 05.06	BCA	4		BKUR6ET-10	2397	24	LPG 1
Golf Plus 1.4	5M1	1.4	59	05.06 -	BUD	4	1,1	ZFR6T-11G	5960		ZFR6T-11G
Golf Plus 1.4	5M1	1.4	59	10.08 -	CGGA	4	1,1	ZFR6T-11G	5960		ZFR6T-11G
Golf Plus 1.4 FSI	5M1	1.4	66	11.04 - 07.06	BLN	4		ZFR6S-Q	6449		ZFR6S-Q
Golf Plus 1.4 TSI	5M1	1.4	90	07.07 -	CAXA	4	0,9	PZFR6R	5758		PZFR6R
Golf Plus 1.4 TSI	5M1	1.4	103	05.06 - 06.08	BMY	4	0,9	PZFR6R	5758		PZFR6R
Golf Plus 1.4 TSI	5M1	1.4	118	07.08 -	CAVD	4	0,9	PZFR6R	5758		PZFR6R
Golf Plus 1.4 TSI	5M1	1.4	125	05.06 - 06.08	BLG	4	0,9	PZFR6R	5758		PZFR6R
Golf Plus 1.6 TDI	5M1	1.6	66	02.09 -	CAYB	4	█	Y1002AS	8888	57	
Golf Plus 1.6	5M1	1.6	75	05.05 -	BSE	4		BKUR6ET-10	2397	24	LPG 1
Golf Plus 1.6	5M1	1.6	75	05.05 -	BSF	4		BKUR6ET-10	2397	24	LPG 1
Golf Plus 1.6	5M1	1.6	75	11.07 - 12.08	CCSA	4		BKUR6ET-10	2397	24	LPG 1
Golf Plus 1.6 BiFuel (LPG)	5M1	1.6	75	05.09 -	CHGA	4		BKUR6ET-10	2397	24	LPG 1
Golf Plus 1.6 TDI	5M1	1.6	77	02.09 -	CAYC	4	█	Y1002AS	8888	57	
Golf Plus 1.6 FSI	5M1	1.6	85	01.05 - 05.08	BLF	4		ZFR6S-Q	6449		ZFR6S-Q
Golf Plus 1.9 TDI	5M1	1.9	66	05.05 - 02.06	BRU	4	█	Y-607AS	7560	50	
Golf Plus 1.9 TDI	5M1	1.9	66	02.06 - 12.08	BXF	4	█	Y-607AS	7560	50	
Golf Plus 1.9 TDI	5M1	1.9	66	05.07 - 12.08	BXJ	4	█	Y-607AS	7560	50	
Golf Plus 1.9 TDI	5M1	1.9	77	01.05 - 05.06	BKC	4	█	Y-607AS	7560	50	



Code *l* kW

Cyl.

Stock-No.  
**VW**

LPG/CNG

**VW****JETTA 3**

Jetta 3 2.0 TDI	1K2	2.0	100	09.05 -	AZV	4	☑	YE14	7768	48	
Jetta 3 2.0 TDI	1K2	2.0	103	08.05 - 06.08	BKD	4	☑	YE14	7768	48	
Jetta 3 2.0 TDI	1K2	2.0	103	10.05 - 06.08	BMM	4	☑	Y-607AS	7560	50	
Jetta 3 2.0 TDI	1K2	2.0	125	06.06 - 06.08	BMN	4	☑	CZ304	9864	55	
Jetta 3 2.0 TSI	1K2	2.0	147	09.05 - 10.10	BPY	4	0,8	PFR7S8EG	1675		PFR8S8EG
Jetta 3 2.0 TSI	1K2	2.0	147	09.05 - 10.10	BWA	4	0,8	PFR7S8EG	1675		PFR8S8EG
Jetta 3 2.0 TSI	1K2	2.0	147	09.05 - 10.10	CAWB	4	0,8	PFR7S8EG	1675		PFR8S8EG
Jetta 3 2.0 TSI	1K2	2.0	147	09.05 - 10.10	CBFA	4	0,8	PFR7S8EG	1675		PFR8S8EG
Jetta 3 2.5	1K2	2.5	125	07.07 -	CCCA	5	1,1	ZFR6T-11G	5960		ZFR6T-11G

**JETTA 4**

Jetta 4 1.2 TSI	162	1.2	77	02.11 -	CBZB	4	0,7	IZFR6P7	97153		IZFR6P7
Jetta 4 1.4 TSI	162	1.4	90	05.11 -	CAXA	4	0,9	PZFR6R	5758		PZFR6R
Jetta 4 1.4 TSI	162	1.4	90	05.11 -	CMSB	4	0,9	PZFR6R	5758		PZFR6R
Jetta 4 1.4 TSI	162	1.4	118	02.11 -	CAVD	4	0,8	PZFR6R8EG	96498		PZFR6R8EG
Jetta 4 1.6 TDI	162	1.6	77	02.11 -	CAYC	4	☑	Y1002AS	8888	57	
Jetta 4 2.0 TDI	162	2.0	103	02.11 -	CFFB	4	☑	Y1002AS	8888	57	
Jetta 4 2.0 TDI	162	2.0	103	02.11 -	CLCB	4	☑	Y1002AS	8888	57	
Jetta 4 2.0 TSI	162	2.0	147	02.11 -	CBFA	4	0,8	PFR7S8EG	1675		PFR8S8EG
Jetta 4 2.0 TSI	162	2.0	147	02.11 -	CCTA	4	0,8	PFR7S8EG	1675		PFR8S8EG
Jetta 4 2.0 TSI	162	2.0	147	02.11 -	CCZA	4	0,8	PFR7S8EG	1675		PFR8S8EG

**KÄFER**

Käfer (MEXICO IMPORT)		1.6	34	01.93 -	ACD	4	0,8	BP5ESA	2285		
-----------------------	--	-----	----	---------	-----	---	-----	--------	------	--	--

**LT**

LT		2.3	105	05.96 - 11.01	AGL	4		BKUR5ET	2789	29	LPG 1
LT		2.4	51	08.92 - 12.95	ACT	6	☑	Y-918J	6285	2	
LT		2.4	51	08.89 - 03.96		5	☑	Y-918J	6285	2	
LT		2.4	66	08.82 - 07.92	DL	6	0,7	BP6ESZ	7639		LPG 2
LT		2.4	70	08.88 - 12.95	1E	6	0,7	BP6ESZ	7639		LPG 2
LT		2.5	65	04.06 -	BJJ	5	☑	CZ104	9826	52	
LT TD		2.4	55	12.82 - 07.92	DW	6	☑	Y-918J	6285	2	
LT TD		2.4	68	12.82 - 03.96		5	☑	Y-918J	6285	2	
LT Td		2.4	68	08.88 - 07.91	1G	6	☑	Y-918J	6285	2	
LT TD		2.4	70	08.91 - 12.95	ACL	6	☑	Y-918J	6285	2	
LT TD		2.4	75	12.82 - 07.92	DV	6	☑	Y-918J	6285	2	
LT TD 4X4		2.4	55	09.85 - 03.96		5	☑	Y-918J	6285	2	
LT TDI		2.5	61	04.01 - 07.06	BBE	5	☑	Y-732J	5605	4	
LT TDI		2.5	66	05.99 - 04.01	APA	5	☑	Y-732J	5605	4	
LT TDI		2.5	70	04.01 - 07.06	BBF	5	☑	Y-732J	5605	4	
LT TDI		2.5	75	05.96 - 05.99	AHD	5	☑	Y-732J	5605	4	
LT TDI		2.5	80	05.99 - 07.06	ANJ	5	☑	Y-732J	5605	4	
LT TDI		2.5	80	12.02 - 07.06	AVR	5	☑	Y-732J	5605	4	
LT 28 D		2.4	51	08.88 - 12.95	1S	6	☑	Y-918J	6285	2	
LT 28 SDI		2.5	55	05.96 -		5	☑	Y-732J	5605	4	
LT 28 TDi		2.8	92	05.96 -		6	☑	Y-732J	5605	4	
LT 31 D		2.4	51	08.88 - 12.95	1S	6	☑	Y-918J	6285	2	
LT 35 SDI		2.5	55	05.96 - 04.01	AGX	5	☑	Y-732J	5605	4	
LT 35 TDi		2.8	92	05.96 -		5	☑	Y-732J	5605	4	
LT 40 D		2.4	51	08.88 - 12.95	1S	6	☑	Y-918J	6285	2	
LT TDI		2.5	80	04.06 -	BJK	5	☑	CZ104	9826	52	
LT TDI		2.5	100	04.06 -	BJL	5	☑	CZ104	9826	52	

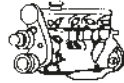

Code *l* kW

Cyl.

Stock-No.  
**V-FLINE**  
10-11-12-13-14-15-16-17-18-19-20-21-22-23-24-25-26-27-28-29-30-31-32-33-34-35-36-37-38-39-40-41-42-43-44-45-46-47-48-49-50-51-52-53-54-55-56-57-58-59-60-61-62-63-64-65-66-67-68-69-70-71-72-73-74-75-76-77-78-79-80-81-82-83-84-85-86-87-88-89-90-91-92-93-94-95-96-97-98-99-100

LPG/CNG

**VW  
LT**

LT TDI		2.5	120	04.06 -	BJM	5		CZ104	9826	52	
--------	--	-----	-----	---------	-----	---	--	-------	------	----	--

**LUPO**

Lupo 1.0	6X1 / 6E1	1.0	37	10.98 - 05.00	AHT	4		BKR6ETA-10	7998		
Lupo 1.0	6X1 / 6E1	1.0	37	10.98 - 05.00	ALL	4		BUR6ET	3172	1	LPG 2
Lupo 1.0	6X1 / 6E1	1.0	37	01.99 - 05.00	AER	4		BUR6ET	3172	1	LPG 2
Lupo 1.0	6X1 / 6E1	1.0	37	05.99 - 07.05	ALD	4	0,9	ZFR5P-G	6893		LPG 6
Lupo 1.0	6X1 / 6E1	1.0	37	05.99 - 05.00	ANV	4	0,9	ZFR5P-G	6893		LPG 6
Lupo 1.0	6X1 / 6E1	1.0	37	05.00 - 07.05	AUC	4	0,9	ZFR5P-G	6893		LPG 6
Lupo 1.2 TDI 3L	6X1 / 6E1	1.2	45	06.99 - 11.00	ANY	3		Y-732J	5605	4	
Lupo 1.2 TDI 3L >6x-2-005 000	6X1 / 6E1	1.2	45	11.00 - 07.05	AYZ	3		Y-732J	5605	4	
Lupo 1.2 TDI 3L 6x-2-005 001>	6X1 / 6E1	1.2	45	11.00 - 07.05	AYZ	3		Y-741U	6943	20	
Lupo 1.4	6X1 / 6E1	1.4	44	09.00 - 07.05	AUD	4	0,9	ZFR5P-G	6893		LPG 6
Lupo 1.4	6X1 / 6E1	1.4	55	07.98 - 05.99	AKQ	4		BKUR6ET-10	2397	24	LPG 1
Lupo 1.4	6X1 / 6E1	1.4	55	01.99 - 07.05	AHW	4		BKUR6ET-10	2397	24	LPG 1
Lupo 1.4	6X1 / 6E1	1.4	55	05.99 - 09.00	APE	4		BKUR6ET-10	2397	24	LPG 1
Lupo 1.4	6X1 / 6E1	1.4	55	05.00 - 04.02	AUA	4		BKUR6ET-10	2397	24	LPG 1
Lupo 1.4	6X1 / 6E1	1.4	55	04.02 - 07.05	BBY	4		BKUR6ET-10	2397	24	LPG 1
Lupo 1.4	6X1 / 6E1	1.4	74	05.99 - 10.00	AFK	4		BKUR6ET-10	2397	24	LPG 1
Lupo 1.4	6X1 / 6E1	1.4	74	05.99 - 05.00	ANM	4		BKUR6ET-10	2397	24	LPG 1
Lupo 1.4	6X1 / 6E1	1.4	74	05.99 - 05.00	AQQ	4		BKUR6ET-10	2397	24	LPG 1
Lupo 1.4	6X1 / 6E1	1.4	74	05.00 - 07.05	AUB	4		BKUR6ET-10	2397	24	LPG 1
Lupo 1.4 FSI	6X1 / 6E1	1.4	77	09.00 - 11.03	ARR	4		ZFR6S-Q	6449		ZFR6S-Q
Lupo 1.4 TDI Fgst >6x-2-005 000	6X1 / 6E1	1.4	55	05.99 - 07.05	AMF	3		Y-732J	5605	4	
Lupo 1.4 TDI Fgst 6x-2-005 001>	6X1 / 6E1	1.4	55	05.99 - 07.05	AMF	3		Y-741U	6943	20	
Lupo 1.6 GTI	6X1 / 6E1	1.6	92	06.00 - 07.05	AVY	4		BKUR6ET-10	2397	24	LPG 1
Lupo 1.7 SDI	6X1 / 6E1	1.7	42	10.98 - 07.05	AKU	3		Y-732J	5605	4	

**PASSAT 3**

Passat 3 1.6	35i/3A2/ 3A5	1.6	53	04.88 - 07.91	1F	4		BUR5ET-10	7264	21	LPG 2
Passat 3 1.6	35i/3A2/ 3A5	1.6	53	08.89 - 07.92	EZ	4		BUR5ET-10	7264	21	LPG 2
Passat 3 1.6	35i/3A2/ 3A5	1.6	55	08.89 - 09.91	ABN	4		BUR5ET-10	7264	21	LPG 2
Passat 3 1.6 TD	35i/3A2/ 3A5	1.6	59	08.89 - 10.93	SB	4		Y-918J	6285	2	
Passat 3 1.6	35i/3A2/ 3A5	1.6	74	10.94 - 12.95	AEK	4		BKUR5ET	2789	29	LPG 1
Passat 3 1.6	35i/3A2/ 3A5	1.6	74	12.95 - 12.96	AFT	4		BKUR6ET-10	2397	24	LPG 1
Passat 3 1.8	35i/3A2/ 3A5	1.8	55	08.90 - 12.96	AAM	4		BUR5ET	3377	22	LPG 2
Passat 3 1.8	35i/3A2/ 3A5	1.8	66	04.88 - 07.91	RP	4		BUR6ET	3172	1	LPG 2
Passat 3 1.8	35i/3A2/ 3A5	1.8	66	08.91 - 09.94	ABS	4		BUR6ET	3172	1	LPG 2
Passat 3 1.8	35i/3A2/ 3A5	1.8	66	08.94 - 12.96	ADZ	4		BUR6ET	3172	1	LPG 2
Passat 3 1.8	35i/3A2/ 3A5	1.8	79	04.88 - 07.93	PF	4		BUR6ET	3172	1	LPG 2

Fgst = Chassis No.

Code *l* kW

Cyl.

Stock-No.  
**VW**  
BY-PROMOTER

LPG/CNG

**VW****PASSAT 3**

Passat 3 1.8	35i/3A2/ 3A5	1.8	82	04.88 - 07.92	PB	4		BUR6ET	3172	1	LPG 2
Passat 3 1.8 GUS	35i/3A2/ 3A5	1.8	85	01.97 - 04.00	AFY	4		BKUR6ET-10	2397	24	LPG 1
Passat 3 1.8 16V	35i/3A2/ 3A5	1.8	100	04.88 - 07.92	KR	4		BCPR7ET	2164		BCPR7EIX
Passat 3 1.9 D	35i/3A2/ 3A5	1.9	50	05.89 - 10.93	1Y	4	■	Y-918J	6285	2	
Passat 3 1.9 TD	35i/3A2/ 3A5	1.9	55	03.91 - 12.96	AAZ	4	■	Y-918J	6285	2	
Passat 3 1.9 TDI	35i/3A2/ 3A5	1.9	66	10.93 - 12.96	1Z	4	■	Y-732J	5605	4	
Passat 3 1.9 TDI	35i/3A2/ 3A5	1.9	66	10.93 - 08.96	AHU	4	■	Y-732J	5605	4	
Passat 3 1.9 TDI	35i/3A2/ 3A5	1.9	81	03.96 - 08.96	AFN	4	■	Y-732J	5605	4	
Passat 3 2.0	35i/3A2/ 3A5	2.0	79	03.95 - 12.96	AEP	4		BUR6ET	3172	1	LPG 2
Passat 3 2.0	35i/3A2/ 3A5	2.0	85	03.90 - 09.94	2E	4		BUR6ET	3172	1	LPG 2
Passat 3 2.0	35i/3A2/ 3A5	2.0	85	10.94 - 12.95	ADY	4		BUR6ET	3172	1	LPG 2
Passat 3 2.0	35i/3A2/ 3A5	2.0	85	07.96 - 12.96	AGG	4		BUR6ET	3172	1	LPG 2
Passat 3 2.0 16V	35i/3A2/ 3A5	2.0	100	04.88 - 10.93	9A	4		BKUR7ET	7873		PFR7Q
Passat 3 2.0 16V	35i/3A2/ 3A5	2.0	110	07.94 - 12.96	ABF	4		BKUR6ET-10	2397	24	LPG 1
Passat 3 2.8 VR6	35i/3A2/ 3A5	2.8	128	06.91 - 06.95	AAA	6		BKR5EKU	3964		
Passat 3 2.8 VR6	35i/3A2/ 3A5	2.8	128	07.95 - 12.96	AAA	6		BKR5EKUP	2890		
Passat 3 2.8 VR6 USA	35i/3A2/ 3A5	2.8	142	10.94 - 12.95	AHA	6		BKR6EKUB	3584		LPG 1
Passat 3 2.9 VR6 Synchro	35i / 3A5	2.9	135	07.94 - 06.95	ABV	6		BKR5EKU	3964		
Passat 3 2.9 VR6 Synchro	35i / 3A5	2.9	135	07.95 - 12.96	ABV	6		BKR5EKUP	2890		

**PASSAT 4**

Passat 4 1.6	3B2 / 3B5	1.6	74	10.96 - 08.00	AHL	4		BKUR6ET-10	2397	24	LPG 1
Passat 4 1.6	3B2 / 3B5	1.6	74	01.97 - 10.97	ADP	4		BKUR6ET-10	2397	24	LPG 1
Passat 4 1.6	3B2 / 3B5	1.6	74	07.99 - 08.00	ANA	4		BKUR6ET-10	2397	24	LPG 1
Passat 4 1.6	3B2 / 3B5	1.6	74	01.99 - 08.00	ARM	4		BKUR6ET-10	2397	24	LPG 1
Passat 4 1.6	3B3 / 3B6	1.6	75	10.00 - 05.05	ALZ	4		BKUR6ET-10	2397	24	LPG 1
Passat 4 1.8	3B2 / 3B5	1.8	92	12.96 - 01.99	ADR	4		BKUR6ET-10	2397	24	LPG 1
Passat 4 1.8	3B2 / 3B5	1.8	92	01.99 - 08.00	APT	4		BKUR6ET-10	2397	24	LPG 1
Passat 4 1.8	3B2 / 3B5	1.8	92	02.99 - 08.00	ARG	4		BKUR6ET-10	2397	24	LPG 1
Passat 4 1.8 T	3B2 / 3B5	1.8	110	10.96 - 12.98	AEB	4	0,8	PFR6Q	6458	37	LPG 1
Passat 4 1.8 T	3B2 / 3B5	1.8	110	01.99 - 08.00	ANB	4	0,8	PFR6Q	6458	37	LPG 1
Passat 4 1.8 T	3B2 / 3B5	1.8	110	01.99 - 08.00	APU	4	0,8	PFR6Q	6458	37	LPG 1
Passat 4 1.8 T	3B3 / 3B6	1.8	110	10.00 - 05.05	AWT	4	0,8	PFR6Q	6458	37	LPG 1
Passat 4 1.8 T China	3B3 / 3B6	1.8	110	12.05 -	BGC	4	0,8	PFR6Q	6458	37	LPG 1

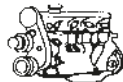
Code *ℓ* kW

Cyl.



Stock-No.



LPG/CNG

**VW  
PASSAT 4**

Passat 4 1.8 T USA	3B2 / 3B5	1.8	110	08.99 - 05.00	ATW	4	0,8	PFR6Q	6458	37	LPG 1
Passat 4 1.8 T USA	3B2 / 3B5	1.8	110	05.00 - 08.00	AUG	4	0,8	PFR6Q	6458	37	LPG 1
Passat 4 1.8 T USA	3B3 / 3B6	1.8	125	02.01 - 05.05	AWM	4	0,8	PFR6Q	6458	37	LPG 1
Passat 4 1.9 TDI	3B2 / 3B5	1.9	66	05.98 - 08.00	AHH	4		Y-732J	5605	4	
Passat 4 1.9 TDI Fgst →	3B2/3B3/	1.9	74	10.00 - 05.05	AVB	4		Y-732J	5605	4	
3B-2-350-000	3B5/3B6										
Passat 4 1.9 TDI Fgst 3B-2-350-001 →	3B2/3B3/	1.9	74	10.00 - 05.05	AVB	4		Y-741U	6943	20	
	3B5/3B6										
Passat 4 1.9 TDI	3B2 / 3B5	1.9	81	08.99 - 08.00	AVG	4		Y-732J	5605	4	
Passat 4 1.9 TDI	3B2 / 3B5	1.9	85	01.99 - 12.99	AJM	4		Y-732J	5605	4	
Passat 4 1.9 TDI	3B2 / 3B5	1.9	85	01.00 - 08.00	ATJ	4		Y-732J	5605	4	
Passat 4 1.9 TDI Fgst → 3B-2-350-000	3B3 / 3B6	1.9	96	10.00 - 05.05	AVF	4		Y-732J	5605	4	
Passat 4 1.9 TDI Fgst 3B-2-350-001 →	3B3 / 3B6	1.9	96	10.00 - 05.05	AVF	4		Y-741U	6943	20	
Passat 4 1.9 TDI Fgst → 3B-2-350-000	3B3 / 3B6	1.9	96	10.00 - 05.05	AWX	4		Y-732J	5605	4	
Passat 4 1.9 TDI Fgst 3B-2-350-001 →	3B3 / 3B6	1.9	96	10.00 - 05.05	AWX	4		Y-741U	6943	20	
Passat 4 2.0	3B3 / 3B6	2.0	85	10.00 - 05.05	AZM	4		BKUR6ET-10	2397	24	LPG 1
Passat 4 2.0	3B3 / 3B6	2.0	85	12.05 -	BFF	4	0,8	PFR6Q	6458	37	LPG 1
Passat 4 2.0 20V	3B3 / 3B6	2.0	96	11.01 - 05.05	ALT	4		BKUR5ET-10	7553		LPG 1
Passat 4 2.3 V5	3B2 / 3B5	2.3	110	10.96 - 08.00	AGZ	5		BKR5EKUP	2890		
Passat 4 2.3 V5	3B3 / 3B6	2.3	125	01.01 - 05.05	AZX	5	1,1	PZFR5D-11	7968	34	LPG 6
Passat 4 2.5 TDI V6	3B2/3B3/	2.5	110	08.98 - 08.00	AFB	6		Y-501U	3786	31	
	3B5/3B6										
Passat 4 2.5 TDI V6	3B2/3B3/	2.5	110	05.99 - 05.03	AKN	6		Y-501U	3786	31	
	3B5/3B6										
Passat 4 2.5 TDI V6	3B3 / 3B6	2.5	120	05.03 - 05.05	BDG	6		Y-501U	3786	31	
Passat 4 2.5 TDI V6 4motion	3B3 / 3B6	2.5	132	01.03 - 05.05	BAU	6		Y-501U	3786	31	
Passat 4 2.5 TDI V6 4motion	3B3 / 3B6	2.5	132	01.03 - 05.05	BDH	6		Y-501U	3786	31	
Passat 4 2.8 V6 China / GUS	3B2/3B3/	2.8	132	09.97 - 09.99	AGE	6		BKR6EKUB	3584		LPG 1
	3B5/3B6										
Passat 4 2.8 V6 China	3B2/3B3/	2.8	140	10.00 - 05.05	BBG	6		BKR6EKUB	3584		LPG 1
	3B5/3B6										
Passat 4 2.8 V6	3B2 / 3B5	2.8	142	06.97 - 12.98	ACK	6		BKR6EKUB	3584		LPG 1
Passat 4 2.8 V6 Synchro	3B2 / 3B5	2.8	142	08.97 - 12.98	ALG	6		BKR6EKUB	3584		LPG 1
Passat 4 2.8 V6	3B2 / 3B5	2.8	142	01.99 - 08.00	APR	6		BKR6EKUB	3584		LPG 1
Passat 4 2.8 V6 4motion	3B2 / 3B5	2.8	142	01.99 - 08.00	AQD	6		BKR6EKUB	3584		LPG 1
Passat 4 2.8 4motion	3B3 / 3B6	2.8	142	10.00 - 05.05	AMX	6		BKR6EKUB	3584		LPG 1
Passat 4 2.8 4motion	3B3 / 3B6	2.8	142	10.00 - 05.05	ATQ	6		BKR6EKUB	3584		LPG 1
Passat 4 4.0 W8 4motion	3B3 / 3B6	4.0	202	09.01 - 09.04	BDN	8		BKR6EKUE	7892		

**PASSAT 5**

Passat 5 1.4 TSI (Typ 3C)	3C2 / 3C5	1.4	90	05.07 -	CAXA	4	0,9	PZFR6R	5758		PZFR6R
Passat 5 1.4 TSI (Typ 3C)	3C2 / 3C5	1.4	118	11.12 -	CTHD	4	0,8	PZFR6R8EG	96498		PZFR6R8EG
Passat 5 1.6 (Typ 3C)	3C2 / 3C5	1.6	75	05.05 - 05.07	BSE	4		BKUR6ET-10	2397	24	LPG 1
Passat 5 1.6 (Typ 3C)	3C2 / 3C5	1.6	75	05.05 -	BSF	4		BKUR6ET-10	2397	24	LPG 1
Passat 5 1.6 TDI (Typ 3C)	3C2 / 3C5	1.6	77	08.09 -	CAYC	4		Y1002AS	8888	57	
Passat 5 1.6 FSI (Typ 3C)	3C2 / 3C5	1.6	85	03.05 -	BLF	4		ZFR6S-Q	6449		ZFR6S-Q
Passat 5 1.8 TSI (Typ 3C)	3C2 / 3C5	1.8	112	11.08 - 05.10	CGYA	4	0,8	PFR7S8EG	1675		PFR8S8EG
Passat 5 1.8 TSI (Typ 3C)	3C2 / 3C5	1.8	118	06.07 - 11.10	BZB	4	0,8	PFR7S8EG	1675		PFR8S8EG
Passat 5 1.8 TSI (Typ 3C)	3C2 / 3C5	1.8	118	11.09 - 10.12	CDAА	4	0,8	PFR7S8EG	1675		PFR8S8EG
Passat 5 1.9 TDI (Typ 3C)	3C2 / 3C5	1.9	77	03.05 - 02.06	BKC	4		Y-607AS	7560	50	
Passat 5 1.9 TDI (Typ 3C)	3C2 / 3C5	1.9	77	06.05 - 05.07	BLS	4		Y-607AS	7560	50	

Fgst = Chassis No.

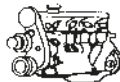
Code *l* kW

Cyl.



Stock-No.



LPG/CNG

VW

**PASSAT 5**

Passat 5 1.9 TDI (Typ 3C)	3C2 / 3C5	1.9	77	02.06 - 11.08	BXE	4	█	Y-607AS	7560	50	
Passat 5 2.0 TDI (Typ 3C)	3C2 / 3C5	2.0	81	11.08 - 11.10	CBDC	4	█	Y1002AS	8888	57	
Passat 5 2.0 TDI (Typ 3C)	3C2 / 3C5	2.0	88	11.05 - 05.07	BWV	4	█	CZ304	9864	55	
Passat 5 2.0 TDI (Typ 3C)	3C2 / 3C5	2.0	90	06.05 -	BVD	4	█	CZ104	9826	52	
Passat 5 2.0 TDI (Typ 3C)	3C2 / 3C5	2.0	90	06.05 - 02.06	BVE	4	█	CZ304	9864	55	
Passat 5 2.0 TDI (Typ 3C)	3C2 / 3C5	2.0	100	03.05 - 05.07	BMA	4	█	CZ304	9864	55	
Passat 5 2.0 TDI (Typ 3C)	3C2 / 3C5	2.0	100	06.07 - 04.09	BMA	4	█	YE14	7768	48	
Passat 5 2.0 TDI (Typ 3C)	3C2 / 3C5	2.0	100	01.08 -	CBAA	4	█	Y-609AS	5849	49	
Passat 5 2.0 TDI (Typ 3C)	3C2 / 3C5	2.0	100	11.10 -	CFFA	4	█	Y1002AS	8888	57	
Passat 5 2.0 TDI (Typ 3C)	3C2 / 3C5	2.0	103	03.05 - 05.07	BKP	4	█	CZ304	9864	55	
Passat 5 2.0 TDI (Typ 3C)	3C2 / 3C5	2.0	103	06.07 - 11.10	BKP	4	█	YE14	7768	48	
Passat 5 2.0 TDI (Typ 3C)	3C2 / 3C5	2.0	103	03.05 - 05.08	BMP	4	█	CZ104	9826	52	
Passat 5 2.0 TDI (Typ 3C)	3C2 / 3C5	2.0	103	05.07 - 11.10	CBAB	4	█	Y-609AS	5849	49	
Passat 5 2.0 TDI (Typ 3C)	3C2 / 3C5	2.0	103	08.10 -	CFFB	4	█	Y1002AS	8888	57	
Passat 5 2.0 TDI (Typ 3C)	3C2 / 3C5	2.0	105	01.09 -	CBAC	4	█	Y1002AS	8888	57	
Passat 5 2.0 FSI (Typ 3C)	3C2 / 3C5	2.0	110	03.05 - 11.05	BLR	4		PZFR5N-11T	7742		PZFR5N-11T
Passat 5 2.0 FSI (Typ 3C)	3C2 / 3C5	2.0	110	09.05 - 11.05	BLX	4		PZFR5N-11T	7742		PZFR5N-11T
Passat 5 2.0 FSI (Typ 3C)	3C2 / 3C5	2.0	110	03.05 - 11.05	BLY	4	0,9	BKR6E	6962	28	LPG 1
Passat 5 2.0 FSI (Typ 3C)	3C2 / 3C5	2.0	110	11.05 - 11.10	BVX	4		PZFR5N-11T	7742		PZFR5N-11T
Passat 5 2.0 FSI (Typ 3C)	3C2 / 3C5	2.0	110	11.05 - 11.10	BVY	4		PZFR5N-11T	7742		PZFR5N-11T
Passat 5 2.0 FSI (Typ 3C)	3C2 / 3C5	2.0	110	11.05 - 11.10	BVZ	4	0,9	BKR6E	6962	28	LPG 1
Passat 5 2.0 TDI (Typ 3C)	3C2 / 3C5	2.0	120	10.05 - 05.09	BUZ	4	█	CZ304	9864	55	
Passat 5 2.0 TDI (Typ 3C)	3C2 / 3C5	2.0	125	02.06 - 11.10	BMR	4	█	CZ304	9864	55	
Passat 5 2.0 TDI (Typ 3C)	3C2 / 3C5	2.0	125	05.08 - 11.10	CBBB	4	█	Y-609AS	5849	49	
Passat 5 2.0 TDI (Typ 3C)	3C2 / 3C5	2.0	125	08.10 -	CFGB	4	█	Y1002AS	8888	57	
Passat 5 2.0 TDI (Typ 3C)	3C2 / 3C5	2.0	125	08.10 -	CLLA	4	█	Y1002AS	8888	57	
Passat 5 2.0 TSI (Typ 3C)	3C2 / 3C5	2.0	125	12.07 - 11.10	CCTA	4	0,8	PFR7S8EG	1675		PFR8S8EG
Passat 5 2.0 TSI (Typ 3C)	3C2 / 3C5	2.0	147	07.05 - 11.05	AXX	4	0,8	PFR7S8EG	1675		PFR8S8EG
Passat 5 2.0 TSI (Typ 3C)	3C2 / 3C5	2.0	147	11.07 - 01.10	CAWB	4	0,8	PFR7S8EG	1675		PFR8S8EG
Passat 5 2.0 TSI (Typ 3C)	3C2 / 3C5	2.0	147	11.09 - 11.10	CCZA	4	0,8	PFR7S8EG	1675		PFR8S8EG
Passat 5 2.0 FSI (Typ 3C)	3C2 / 3C5	2.0	147	08.05 - 07.10	BPY	4	0,8	PFR7S8EG	1675		PFR8S8EG
Passat 5 2.0 FSI (Typ 3C)	3C2 / 3C5	2.0	147	11.05 - 12.07	BWA	4	0,8	PFR7S8EG	1675		PFR8S8EG
Passat 5 2.0 TSI (Typ 3C)	3C2 / 3C5	2.0	155	11.10 -	CCZB	4	0,8	PFR7S8EG	1675		PFR8S8EG
Passat 5 3.2 FSI 4motion (Typ 3C)	3C2 / 3C5	3.2	184	09.05 - 05.07	AXZ	6	0,9	ILZKR7A	1961		ILZKR7A
Passat 5 3.6 R36 4motion (Typ 3C)	3C2 / 3C5	3.6	220	04.07 - 11.10	BWS	6	0,8	ILZKR8A	94290		ILZKR8A

**PHAETON**

Phaeton 3.0 V6 TDI	3D2	3.0	171	09.04 - 05.07	BMK	6	█	Y-609AS	5849	49	
Phaeton 3.0 V6 TDI	3D2	3.0	172	06.07 - 10.08	CARA	6	█	Y-609AS	5849	49	
Phaeton 3.0 V6 TDI	3D2	3.0	176	05.08 - 05.10	CEXA	6	█	Y-609AS	5849	49	
Phaeton 3.2 V6	3D2	3.2	177	05.02 - 05.05	AYT	6	0,9	IZKR7B	7563		IZKR7B
Phaeton 3.2 V6	3D2	3.2	177	08.03 - 10.08	BKL	6	0,9	IZKR7B	7563		IZKR7B
Phaeton 3.6 V6	3D2	3.6	206	11.08 - 05.10	CHNA	6	0,9	ILZKR7A	1961		ILZKR7A
Phaeton 3.6 V6	3D2	3.6	206	05.10 -	CMVA	6	0,9	ILZKR7A	1961		ILZKR7A
Phaeton 4.2 V8	3D2	4.2	246	08.03 -	BGH	8		BKR6EQUA	6872		LPG 1
Phaeton 4.2 V8	3D2	4.2	246	05.03 - 07.03	BGJ	8		BKR6EQUA	6872		LPG 1
Phaeton 5.0 V10 TDI	3D2	5.0	230	12.02 - 10.06	AJS	10	█	Y-741U	6943	20	
Phaeton 6.0 W12	3D2	6.0	309	05.02 - 05.05	BAN	12	1,1	PZFR6J-11	3586		LPG 6
Phaeton 6.0 W12	3D2	6.0	309	10.03 -	BAP	12	1,1	PZFR6J-11	3586		LPG 6
Phaeton 6.0 W12	3D2	6.0	331	05.05 - 10.08	BRN	12	1,1	PZFR6J-11	3586		LPG 6
Phaeton 6.0 W12	3D2	6.0	331	05.05 - 10.08	BTT	12	1,1	PZFR6J-11	3586		LPG 6

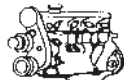
Code *ℓ* kW

Cyl.



Stock-No.



LPG/CNG

**VW  
POLO 2**

Polo 2 1.0	86C	1.0	33	08.89 - 12.92	ACM	4		BUR6ET	3172	1	LPG 2
Polo 2 1.0	86C	1.0	33	08.89 - 01.92	HZ	4		BUR6ET	3172	1	LPG 2
Polo 2 1.0	86C	1.0	33	10.90 - 07.94	AAU	4		BUR5ET	3377	22	LPG 2
Polo 2 1.3	86C	1.3	40	01.89 - 07.94	2G	4		BUR6ET	3172	1	LPG 2
Polo 2 1.3	86C	1.3	40	08.89 - 08.91	MH	4		BUR6ET	3172	1	LPG 2
Polo 2 1.3	86C	1.3	40	08.89 - 12.92	NZ	4		BUR6ET	3172	1	LPG 2
Polo 2 1.3	86C	1.3	40	01.91 - 07.94	AAV	4		BUR5ET	3377	22	LPG 2
Polo 2 1.3	86C	1.3	55	01.90 - 07.94	3F	4		BUR6ET	3172	1	LPG 2
Polo 2 1.4 D	86C	1.4	35	10.90 - 07.94	1W	4		Y-918J	6285	2	

**POLO 3**

Polo 3 1.0	6N1	1.0	33	10.94 - 06.96	AEV	4		BUR6ET	3172	1	LPG 2
Polo 3 1.0	6N1	1.0	37	07.96 - 12.99	AER	4		BUR6ET	3172	1	LPG 2
Polo 3 1.0	6N1	1.0	37	08.97 - 12.99	ALL	4		BUR6ET	3172	1	LPG 2
Polo 3 1.0	6N2	1.0	37	10.99 - 09.01	ALD	4	1,1	PZFR5D-11	7968	34	LPG 6
Polo 3 1.0	6N2	1.0	37	10.99 - 09.01	AUC	4	1,1	PZFR5D-11	7968	34	LPG 6
Polo 3 1.3	6N1	1.3	40	10.94 - 04.97	ADX	4		BUR6ET	3172	1	LPG 2
Polo 3 1.4	6N2	1.4	40	10.99 - 09.01	AKP	4	1,1	PZFR5D-11	7968	34	LPG 6
Polo 3 1.4	6N2	1.4	44	01.98 - 12.99	ANX	4		BUR6ET	3172	1	LPG 2
Polo 3 1.4	6N1	1.4	44	07.95 - 12.97	AEX	4		BUR6ET	3172	1	LPG 2
Polo 3 1.4	6N1	1.4	44	05.97 - 12.99	AKV	4		BUR6ET	3172	1	LPG 2
Polo 3 1.4	6N1	1.4	44	11.97 - 12.99	APQ	4		BUR6ET	3172	1	LPG 2
Polo 3 1.4	6N2	1.4	44	10.99 - 09.01	AKK	4	1,1	PZFR5D-11	7968	34	LPG 6
Polo 3 1.4 Variant	6KV2 / 6KV5	1.4	44	10.99 - 08.00	ANW	4	1,1	PZFR5D-11	7968	34	LPG 6
Polo 3 1.4	6N2	1.4	44	10.99 - 09.01	AUD	4	1,1	PZFR5D-11	7968	34	LPG 6
Polo 3 1.4 16V	6N2	1.4	55	10.99 - 09.01	AHW	4		BKUR6ET-10	2397	24	LPG 1
Polo 3 1.4 16V	6N2	1.4	55	10.99 - 06.00	APE	4		BKUR6ET-10	2397	24	LPG 1
Polo 3 1.4 16V	6N2	1.4	55	10.99 - 01.02	AUA	4		BKUR6ET-10	2397	24	LPG 1
Polo 3 1.4 TDI	6N2	1.4	55	10.99 - 05.05	AMF	3		Y-741U	6943	20	
Polo 3 1.4 16V	6N1	1.4	74	04.96 - 12.99	AFH	4		BKUR6ET-10	2397	24	LPG 1
Polo 3 1.4 16V	6N2	1.4	74	10.99 - 09.01	AFK	4		BKUR6ET-10	2397	24	LPG 1
Polo 3 1.4 16V	6N2	1.4	74	07.99 - 05.00	AQQ	4		BKUR6ET-10	2397	24	LPG 1
Polo 3 1.4 16V	6N2	1.4	74	05.00 - 06.02	AUB	4		BKUR6ET-10	2397	24	LPG 1
Polo 3 1.6	6N1	1.6	55	10.94 - 07.95	AEA	4		BUR6ET	3172	1	LPG 2
Polo 3 1.6	6N1	1.6	55	07.95 - 12.99	AEE	4		BUR6ET	3172	1	LPG 2
Polo 3 1.6 GTI	6N1	1.6	88	08.98 - 12.99	AJV	4		BKUR6ET-10	2397	24	LPG 1
Polo 3 1.6 GTI	6N2	1.6	92	11.99 - 09.01	ARC	4		BKUR6ET-10	2397	24	LPG 1
Polo 3 1.6 GTI	6N2	1.6	92	05.00 - 09.01	AVY	4		BKUR6ET-10	2397	24	LPG 1
Polo 3 1.7 SDI	6N1	1.7	42	04.97 - 12.99	AHG	4		Y-732J	5605	4	
Polo 3 1.7 SDI	6N1 / 6N2	1.7	44	08.97 - 09.01	AKU	3		Y-732J	5605	4	
Polo 3 1.9 D	6N1 / 6N2	1.9	47	10.94 - 12.99	AEF	4		Y-918J	6285	2	
Polo 3 1.9 SDI	6N1 / 6N2	1.9	47	07.96 - 09.01	AGD	4		Y-732J	5605	4	
Polo 3 1.9 SDI	6N2	1.9	47	10.99 - 09.01	ASX	4		Y-732J	5605	4	
Polo 3 1.9 SDI Variant	6KV2 / 6KV5	1.9	50	10.99 - 09.01	AGP	4		Y-732J	5605	4	
Polo 3 1.9 SDI Variant	6KV2 / 6KV5	1.9	50	10.99 - 09.01	AQM	4		Y-732J	5605	4	
Polo 3 1.9 TDI Variant	6KV2 / 6KV5	1.9	66	01.97 - 08.99	AHU	4		Y-732J	5605	4	
Polo 3 1.9 TDI Variant	6KV2 / 6KV5	1.9	66	11.97 - 08.99	ALE	4		Y-732J	5605	4	
Polo 3 1.9 TDI Variant	6KV2 / 6KV5	1.9	66	10.99 - 09.01	AGR	4		Y-732J	5605	4	
Polo 3 1.9 TDI Variant	6KV2 / 6KV5	1.9	66	10.99 - 09.01	ALH	4		Y-732J	5605	4	
Polo 3 1.9 TDI Variant	6KV2 / 6KV5	1.9	81	06.98 - 08.99	AFN	4		Y-732J	5605	4	
Polo 3 1.9 TDI Variant	6KV2 / 6KV5	1.9	81	10.99 - 09.01	ASV	4		Y-732J	5605	4	



Code *l* kW

Cyl.

Stock-No.  
**VW**

LPG/CNG

**VW****POLO 4**

Polo 4 1.2	9N	1.2	40	01.02 - 05.04	AWY	3	0,9	ZFR5P-G	6893		LPG 6
Polo 4 1.2	9N	1.2	40	05.04 - 05.07	BMD	3	0,9	ZFR5P-G	6893		LPG 6
Polo 4 1.2	9N	1.2	44	05.07 - 11.09	BBM	3	0,9	ZFR5P-G	6893		LPG 6
Polo 4 1.2	9N	1.2	47	11.04 - 07.07	BME	3	0,9	ZFR5P-G	6893		LPG 6
Polo 4 1.2 12V	9N	1.2	47	11.01 - 05.04	AZQ	3	0,9	ZFR5P-G	6893		LPG 6
Polo 4 1.2	9N	1.2	52	05.07 - 11.09	BZG	3	0,9	ZFR5P-G	6893		LPG 6
Polo 4 1.4 TDI	9N	1.4	51	04.05 - 11.09	BNM	3	█	Y-741U	6943	20	
Polo 4 1.4 TDI	9N	1.4	51	05.06 - 11.09	BWB	3	█	CZ104	9826	52	
Polo 4 1.4 16V	9N	1.4	55	11.01 - 05.04	BBY	4		BKUR6ET-10	2397	24	LPG 1
Polo 4 1.4 16V	9N	1.4	55	05.04 - 05.08	BKY	4	0,9	ZFR5P-G	6893		LPG 6
Polo 4 1.4 16V Automatic	9N	1.4	55	11.01 - 05.04	BBY	4	1,1	PZFR5D-11	7968	34	LPG 6
Polo 4 1.4 TDI	9N	1.4	55	11.01 - 05.05	BAY	3	█	Y-741U	6943	20	
Polo 4 1.4 16V	9N	1.4	59	05.06 - 11.09	BUD	4	1,1	ZFR6T-11G	5960		ZFR6T-11G
Polo 4 1.4 TDI	9N	1.4	59	10.05 - 11.09	BMS	3	█	CZ104	9826	52	
Polo 4 1.4 TDI	9N	1.4	59	04.05 - 11.09	BNV	3	█	Y-741U	6943	20	
Polo 4 1.4 FSI	9N	1.4	63	02.02 - 07.06	AXU	4		ZFR6S-Q	6449		ZFR6S-Q
Polo 4 1.4 16V	9N	1.4	74	05.02 - 05.08	BBZ	4		BKUR6ET-10	2397	24	LPG 1
Polo 4 1.6 16V	9N	1.6	77	05.06 - 11.09	BTS	4	1,1	ZFR6T-11G	5960		ZFR6T-11G
Polo 4 1.8 GTI	9N	1.8	110	09.05 - 11.09	BJX	4	0,8	PFR6Q	6458	37	LPG 1
Polo 4 1.8 GTI Cup Edition	9N	1.8	132	05.06 - 11.09	BBU	4	0,8	PFR6Q	6458	37	LPG 1
Polo 4 1.9 SDI	9N	1.9	47	11.01 - 11.09	ASY	4	█	Y-732J	5605	4	
Polo 4 1.9 TDI	9N	1.9	74	11.01 - 11.09	ATD	4	█	Y-741U	6943	20	
Polo 4 1.9 TDI	9N	1.9	74	11.01 - 11.09	AXR	4	█	Y-741U	6943	20	
Polo 4 1.9 TDI	9N	1.9	74	05.06 - 11.09	BMT	4	█	Y-607AS	7560	50	
Polo 4 1.9 TDI	9N	1.9	96	11.03 - 11.09	ASZ	4	█	Y-741U	6943	20	
Polo 4 1.9 TDI	9N	1.9	96	05.04 - 11.09	BLT	4	█	Y-741U	6943	20	

**POLO 5**

Polo 5 1.2	6R	1.2	44	06.09 -	CGPB	3	1,1	ZFR6T-11G	5960		ZFR6T-11G
Polo 5 1.2	6R	1.2	51	06.09 -	CGPA	3	1,1	ZFR6T-11G	5960		ZFR6T-11G
Polo 5 1.2 TDI	6R	1.2	55	10.09 -	CFWA	3	█	Y1002AS	8888	57	
Polo 5 1.2 TSI	6R	1.2	66	05.11 -	CBZC	4	0,7	IZFR6P7	97153		IZFR6P7
Polo 5 1.2 TSI	6R	1.2	77	06.09 -	CBZB	4	0,7	IZFR6P7	97153		IZFR6P7
Polo 5 1.4 BiFuel	6R	1.4	60	03.10 - 01.11	CMAA	4	1,1	ZFR6T-11G	5960		ZFR6T-11G
Polo 5 1.4	6R	1.4	63	06.09 -	CGGB	4	1,1	ZFR6T-11G	5960		ZFR6T-11G
Polo 5 1.4 TSI GTI	6R	1.4	132	05.10 -	CAVE	4	0,8	PZFR6R8EG	96498		PZFR6R8EG
Polo 5 1.6 TDI	6R	1.6	55	05.09 -	CAYA	4	█	Y1002AS	8888	57	
Polo 5 1.6 BiFuel	6R	1.6	60	01.11 -	CNKA	4	1,1	ZFR6T-11G	5960		
Polo 5 1.6 RUS	6R	1.6	63	11.10 - 04.12	CFNB	4	1,1	ZFR6T-11G	5960		
Polo 5 1.6 TDI	6R	1.6	66	06.09 -	CAYB	4	█	Y1002AS	8888	57	
Polo 5 1.6 RUS	6R	1.6	77	05.10 -	CFNA	4	1,1	ZFR6T-11G	5960		
Polo 5 1.6 TDI	6R	1.6	77	05.09 -	CAYC	4	█	Y1002AS	8888	57	
Polo 5 1.6 TDI	6R	1.6	77	05.09 -	CLNA	4	█	Y1002AS	8888	57	

**SCIROCCO 2**

Scirocco 2 1.6	53B	1.6	55	01.83 - 07.91	EW	4		BUR5ET-10	7264	21	LPG 2
Scirocco 2 1.8	53B	1.8	66	08.83 - 07.92	EX	4		BUR6ET	3172	1	LPG 2
Scirocco 2 1.8	53B	1.8	70	08.83 - 07.92	JH	4		BUR6ET	3172	1	LPG 2
Scirocco 2 1.8	53B	1.8	82	08.82 - 07.92	DX	4		BUR6ET	3172	1	LPG 2
Scirocco 2 1.8	53B	1.8	82	08.82 - 07.91	JJ	4		BUR6ET	3172	1	LPG 2
Scirocco 2 1.8	53B	1.8	82	08.83 - 07.91	KT	4		BUR6ET	3172	1	LPG 2
Scirocco 2 1.8 16V	53B	1.8	95	02.86 - 07.92	PL	4		BKUR7ET	7873		PFR7Q

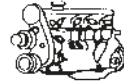
Code *ℓ* kW

Cyl.



Stock-No.



LPG/CNG

**VW  
SCIROCCO 3**

Scirocco 3 1.4 TSI	137	1.4	90	11.08 -	CAXA	4	0,9	PZFR6R	5758		PZFR6R
Scirocco 3 1.4 TSI	137	1.4	118	08.08 -	CAVD	4	0,9	PZFR6R	5758		PZFR6R
Scirocco 3 2.0 TDI	137	2.0	103	08.08 -	CBDB	4	<input checked="" type="checkbox"/>	Y1002AS	8888	57	
Scirocco 3 2.0 TDI	137	2.0	125	05.09 -	CBBB	4	<input checked="" type="checkbox"/>	Y1002AS	8888	57	
Scirocco 3 2.0 TSI	137	2.0	147	08.08 -	CAWB	4	0,8	PFR7S8EG	1675		PFR8S8EG
Scirocco 3 2.0 TSI	137	2.0	155	11.09 -	CCZB	4	0,8	PFR7S8EG	1675		PFR8S8EG
Scirocco 3 2.0 TSI R	137	2.0	188	11.09 -	CDLC	4	0,8	PFR7S8EG	1675		PFR8S8EG
Scirocco 3 2.0 TSI R	137	2.0	195	11.09 -	CDLA	4	0,8	PFR7S8EG	1675		PFR8S8EG

**SHARAN 1**

Sharan 1 1.8 T		1.8	110	11.97 - 02.00	AJH	4	0,8	PFR6Q	6458	37	LPG 1
Sharan 1 1.9 TDI		1.9	66	09.95 - 07.96	1Z	4	<input checked="" type="checkbox"/>	Y-732J	5605	4	
Sharan 1 1.9 TDI		1.9	66	08.96 - 02.00	AHU	4	<input checked="" type="checkbox"/>	Y-732J	5605	4	
Sharan 1 1.9 TDI		1.9	66	03.99 - 02.00	ANU	4	<input checked="" type="checkbox"/>	Y-741U	6943	20	
Sharan 1 1.9 TDI		1.9	81	02.96 - 07.99	AFN	4	<input checked="" type="checkbox"/>	Y-732J	5605	4	
Sharan 1 1.9 TDI		1.9	81	08.99 - 02.00	AVG	4	<input checked="" type="checkbox"/>	Y-732J	5605	4	
Sharan 1 2.0		2.0	85	09.95 - 02.00	ADY	4		BKUR6ET-10	2397	24	LPG 1
Sharan 1 2.8 VR6		2.8	128	09.95 - 03.98	AAA	6		BKR5EKUP	2890		
Sharan 1 2.8 VR6		2.8	128	04.98 - 02.00	AMY	6		BKR5EKUP	2890		

**SHARAN 2**

Sharan 2 1.8 T		1.8	110	04.00 - 05.05	AWC	4	0,8	PFR6Q	6458	37	LPG 1
Sharan 2 1.9 TDI		1.9	85	04.00 - 03.10	AUY	4	<input checked="" type="checkbox"/>	Y-741U	6943	20	
Sharan 2 1.9 TDI		1.9	85	11.05 - 03.10	BVK	4	<input checked="" type="checkbox"/>	Y-741U	6943	20	
Sharan 2 1.9 TDI		1.9	96	11.02 - 03.10	ASZ	4	<input checked="" type="checkbox"/>	Y-741U	6943	20	
Sharan 2 1.9 TDI		1.9	110	01.05 - 05.07	BTB	4	<input checked="" type="checkbox"/>	Y-741U	6943	20	
Sharan 2 2.0 LPG		2.0	85	04.00 - 03.10	ATM	4		BKUR6ET-10	2397	24	LPG 1
Sharan 2 2.0 TDI		2.0	100	11.05 - 03.10	BVH	4	<input checked="" type="checkbox"/>	CZ104	9826	52	
Sharan 2 2.0 TDI		2.0	103	11.05 - 03.10	BRT	4	<input checked="" type="checkbox"/>	CZ104	9826	52	
Sharan 2 2.8 V6		2.8	150	04.00 - 03.10	AYL	6	1,1	PZFR5D-11	7968	34	LPG 6

**SHARAN 3**

Sharan 3 1.4 TSI	7N	1.4	110	05.10 -	CAVA	4	0,9	PZFR6R	5758		PZFR6R
Sharan 3 2.0 TDI	7N	2.0	85	06.11 -	CFFE	4	<input checked="" type="checkbox"/>	Y1002AS	8888	57	
Sharan 3 2.0 TDI	7N	2.0	100	05.10 -	CFFA	4	<input checked="" type="checkbox"/>	Y1002AS	8888	57	
Sharan 3 2.0 TDI	7N	2.0	103	05.10 -	CFFB	4	<input checked="" type="checkbox"/>	Y1002AS	8888	57	
Sharan 3 2.0 TDI	7N	2.0	125	08.10 -	CFGB	4	<input checked="" type="checkbox"/>	Y1002AS	8888	57	
Sharan 3 2.0 TSI	7N	2.0	147	11.10 -	CCZA	4	0,8	PFR7S8EG	1675		PFR8S8EG

**TRANSPORTER**

T 3 1.7 D		1.7	42	10.86 - 07.92	KY	4	<input checked="" type="checkbox"/>	Y-918J	6285	2	
T 3 1.9		1.9	44	08.89 - 07.92	DF	4		BUR6ET	3172	1	LPG 2
T 3 1.9		1.9	57	08.82 - 07.92	DG	4		BUR6ET	3172	1	LPG 2
T 3 2.1		2.1	64	08.86 - 07.92	SR	4	0,7	B6ES	7310		
T 3 2.1		2.1	68	08.85 - 07.92	SS	4	0,7	B6ES	7310		
T 3 2.1		2.1	70	08.85 - 07.92	MV	4	0,7	B6ES	7310		
T 3 2.1		2.1	82	08.84 - 07.92	DJ	4		BUR6ET	3172	1	LPG 2
T 4 1.8		1.8	49	09.90 - 07.92	PD	4		BUR6ET	3172	1	LPG 2
T 4 1.9 D		1.9	44	09.90 - 12.95	1X	4	<input checked="" type="checkbox"/>	Y-918J	6285	2	
T 4 1.9 TD		1.9	50	10.92 - 04.02	ABL	4	<input checked="" type="checkbox"/>	Y-918J	6285	2	
T 4 2.0		2.0	62	09.90 - 06.03	AAC	4		BUR5ET	3377	22	LPG 2
T 4 2.4 D		2.4	55	04.97 - 06.03	AJA	5	<input checked="" type="checkbox"/>	Y-918J	6285	2	
T 4 2.5 TDI		2.5	65	05.98 - 09.03	AJT	5	<input checked="" type="checkbox"/>	Y-732J	5605	4	

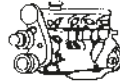
Code *l* kW

Cyl.

Stock-No.  
**V-TIME**  
BY-PROMOTER

LPG/CNG

**VW****TRANSPORTER**

T 4 2.5 TDI		2.5	65	10.01 - 09.03	AYY	5	☑	Y-732J	5605	4	
T 4 2.5 TDI		2.5	75	11.99 - 09.03	AUF	5	☑	Y-732J	5605	4	
T 4 2.5 TDI		2.5	75	04.01 - 09.03	AXL	5	☑	Y-732J	5605	4	
T 4 2.5		2.5	81	09.90 - 12.93	AAF	5		BPR5EKU	5685		LPG 2
T 4 2.5		2.5	81	08.93 - 10.96	ACU	5		BUR5ET	3377	22	LPG 2
T 4 2.5		2.5	81	05.95 - 12.95	AEN	5		BUR5ET	3377	22	LPG 2
T 4 2.5		2.5	81	08.96 - 09.03	AET	5		BUR5ET	3377	22	LPG 2
T 4 2.5 China / GUS		2.5	81	08.96 - 06.03	AEU	5		BUR5ET	3377	22	LPG 2
T 4 2.5		2.5	85	05.99 - 12.99	APL	5		BKUR5ET	2789	29	LPG 1
T 4 2.5		2.5	85	12.99 - 06.03	AVT	5		BKUR5ET	2789	29	LPG 1
T 4 2.5 TDI		2.5	111	07.99 - 09.00	AHY	5	☑	Y-732J	5605	4	
T 4 D		2.4	57	09.90 - 04.98	AAB	5	☑	Y-918J	6285	2	
T 4 TDI		2.5	75	09.95 - 06.03	ACV	5	☑	Y-732J	5605	4	
T 4 TDI		2.5	75	04.01 - 09.03	AYC	5	☑	Y-732J	5605	4	
T 4 TDI		2.5	111	09.00 - 09.03	AXG	5	☑	Y-732J	5605	4	
T 4 2.8 VR6		2.8	103	01.96 - 05.00	AES	6		BKR5EKUP	2890		
T 4 2.8 V6		2.8	150	05.00 - 09.03	AMV	6	1,1	PZFR5D-11	7968	34	LPG 6
T 4 2.8 V6 USA		2.8	150	05.00 - 06.03	AXK	6	1,1	PZFR5D-11	7968	34	LPG 6
T 5 1.9 TDI		1.9	62	01.06 -	BRR	4	☑	Y-607AS	7560	50	
T 5 1.9 TDI		1.9	63	04.03 - 05.07	AXC	4	☑	Y-741U	6943	20	
T 5 1.9 TDI		1.9	75	01.06 -	BRS	4	☑	Y-607AS	7560	50	
T 5 1.9 TDI		1.9	77	04.03 - 05.07	AXB	4	☑	Y-741U	6943	20	
T 5 2.0 TDI		2.0	62	09.09 -	CAAA	4	☑	Y1002AS	8888	57	
T 5 2.0 TDI		2.0	75	09.09 -	CAAB	4	☑	Y1002AS	8888	57	
T 5 2.0		2.0	85	11.03 - 05.07	AXA	4		BKUR6ET-10	2397	24	LPG 1
T 5 2.0 TDI		2.0	103	09.09 -	CCHA	4	☑	Y1002AS	8888	57	
T 5 2.0 TDI		2.0	103	09.09 -	CAAC	4	☑	Y1002AS	8888	57	
T 5 2.0 BiTDI		2.0	132	09.09 -	CFCA	4	☑	Y1002AS	8888	57	
T5 2.0 TSI		2.0	150	05.11 -	CJKA	4	0,8	PFR7S8EG	1675		PFR8S8EG
T 5 2.5 TDI		2.5	96	04.03 - 05.07	AXD	5	☑	Y-741U	6943	20	
T 5 2.5 TDI		2.5	96	01.06 -	BNZ	5	☑	CZ104	9826	52	
T 5 2.5 TDI		2.5	120	11.03 -	BLJ	5	☑	Y-741U	6943	20	
T 5 2.5 TDI		2.5	128	04.03 - 05.07	AXE	5	☑	Y-741U	6943	20	
T 5 2.5 TDI		2.5	128	01.06 -	BPC	5	☑	CZ104	9826	52	
T 5 3.2 V6		3.2	170	02.04 - 05.07	BDL	6	0,9	IZKR7B	7563		IZKR7B
T 5 3.2 V6		3.2	173	02.04 -	BKK	6	0,9	IZKR7B	7563		IZKR7B

**TARO**

Taro 1.8		1.8	61	02.89 - 09.94	2Y	4	1,1	BPR5EY-11	3028		LPG 2
Taro 2.2		2.2	69	06.89 - 07.94	4Y	4	1,1	BPR5EY-11	3028		LPG 2

**TIGUAN**

Tiguan 1.4 TSI	5N	1.4	90	08.10 -	CAXA	4	0,9	PZFR6R	5758		PZFR6R
Tiguan 1.4 TSI	5N	1.4	110	11.07 - 11.08	BWK	4	0,9	PZFR6R	5758		PZFR6R
Tiguan 1.4 TSI	5N	1.4	110	05.08 -	CAVA	4	0,9	PZFR6R	5758		PZFR6R
Tiguan 1.4 TSI	5N	1.4	118	05.11 -	CAVD	4	0,8	PZFR6R8EG	96498		PZFR6R8EG
Tiguan 2.0 TDI	5N	2.0	81	05.10 -	CFFD	4	☑	Y1002AS	8888	57	
Tiguan 2.0 TDI	5N	2.0	100	11.07 - 05.10	CBAA	4	☑	Y-609AS	5849	49	
Tiguan 2.0 TDI	5N	2.0	100	05.10 -	CFFA	4	☑	Y1002AS	8888	57	
Tiguan 2.0 TDI	5N	2.0	103	11.07 -	CBAB	4	☑	Y-609AS	5849	49	
Tiguan 2.0 TDI	5N	2.0	103	11.09 -	CFFB	4	☑	Y1002AS	8888	57	

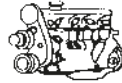
Code *ℓ* kW

Cyl.

Stock-No.  
**VLINE**  
ID-PRG/ID-PRG

LPG/CNG

**VW  
TIGUAN**

Tiguan 2.0 TDI	5N	2.0	103	11.10 -	CLJA	4	☑	Y1002AS	8888	57	
Tiguan 2.0 TDI	5N	2.0	120	02.08 - 05.10	CBBA	4	☑	Y-609AS	5849	49	
Tiguan 2.0 TDI	5N	2.0	125	02.08 - 07.09	CBBB	4	☑	Y-609AS	5849	49	
Tiguan 2.0 TDI	5N	2.0	125	05.10 -	CFGB	4	☑	Y1002AS	8888	57	
Tiguan 2.0 TSI	5N	2.0	125	11.07 -	CCTA	4	0,8	PFR7S8EG	1675		PFR8S8EG
Tiguan 2.0 TSI	5N	2.0	125	01.08 -	CAWA	4	0,8	PFR7S8EG	1675		PFR8S8EG
Tiguan 2.0 TSI	5N	2.0	125	11.09 -	CCZC	4	0,8	PFR7S8EG	1675		PFR8S8EG
Tiguan 2.0 TSI	5N	2.0	132	05.11 -	CCZD	4	0,8	PFR7S8EG	1675		PFR8S8EG
Tiguan 2.0 TSI	5N	2.0	147	11.07 - 05.10	CAWB	4	0,8	PFR7S8EG	1675		PFR8S8EG
Tiguan 2.0 TSI	5N	2.0	147	11.09 -	CCZA	4	0,8	PFR7S8EG	1675		PFR8S8EG
Tiguan 2.0 TSI	5N	2.0	155	05.11 -	CCZB	4	0,8	PFR7S8EG	1675		PFR8S8EG

**TOUAREG 1**

Touareg 2.5 TDI	7LA/7L6/ 7L7	2.5	120	07.03 - 11.06	BLK	5	☑	Y-741U	6943	20	
Touareg 2.5 TDI	7LA/7L6/ 7L7	2.5	120	01.06 - 05.10	BPD	5	☑	GZ104	9826	52	
Touareg 2.5 TDI	7LA/7L6/ 7L7	2.5	128	01.03 - 11.06	BAC	5	☑	Y-741U	6943	20	
Touareg 2.5 TDI	7LA/7L6/ 7L7	2.5	128	01.06 - 05.10	BPE	5	☑	GZ104	9826	52	
Touareg 3.0 TDI	7LA/7L6/ 7L7	3.0	155	04.06 - 11.07	BUN	6	☑	Y-609AS	5849	49	
Touareg 3.0 TDI	7LA/7L6/ 7L7	3.0	155	11.07 - 05.10	CASB	6	☑	Y-609AS	5849	49	
Touareg 3.0 TDI	7LA/7L6/ 7L7	3.0	165	11.04 - 05.08	BKS	6	☑	Y-609AS	5849	49	
Touareg 3.0 TDI	7LA/7L6/ 7L7	3.0	176	01.08 - 05.10	CASC	6	☑	Y-609AS	5849	49	
Touareg 3.0 TDI	7LA/7L6/ 7L7	3.0	177	11.07 - 05.10	CASA	6	☑	Y-609AS	5849	49	
Touareg 3.2	7LA/7L6 /7L7	3.2	162	11.02 - 05.04	AZZ	6	0,9	IZKR7B	7563		IZKR7B
Touareg 3.2	7LA/7L6/ 7L7	3.2	162	05.03 - 05.04	BKJ	6	0,9	IZKR7B	7563		IZKR7B
Touareg 3.2	7LA/7L6/ 7L7	3.2	162	05.04 - 11.06	BMV	6	0,9	IZKR7B	7563		IZKR7B
Touareg 3.2	7LA/7L6/ 7L7	3.2	162	05.04 - 11.06	BMX	6	0,9	IZKR7B	7563		IZKR7B
Touareg 3.2 USA	7LA/7L6/ 7L7	3.2	162	08.03 - 05.04	BAA	6	0,9	IZKR7B	7563		IZKR7B
Touareg 3.6 FSI	7LA/7L6/ 7L7	3.6	206	10.05 - 05.10	BHK	6	0,9	ILZKR7A	1961		ILZKR7A
Touareg 4.2	7LA/7L6/ 7L7	4.2	228	12.02 - 11.06	AXQ	8		BKR6EQUA	6872		LPG 1
Touareg 4.2	7LA/7L6/ 7L7	4.2	258	12.06 - 05.10	BAR	8		PFR6W-TG	5547		
Touareg 5.0 V10 TDI	7LA/L7 7L6/7	5.0	230	11.04 - 05.10	BLE	10	☑	GZ104	9826	52	
Touareg 5.0 V10 TDI	7LA/7L6/ 7L7	5.0	230	11.02 - 11.06	AYH	10	☑	Y-741U	6943	20	

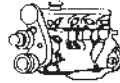
Code *l* kW

Cyl.



Stock-No.



LPG/CNG

VW

**TOUAREG 1**

Touareg WR 12	7LA/7L6/ 7L7	6.0	316	08.04 - 05.10	BJN	12	1,1	PZFR6J-11	3586		LPG 6
---------------	-----------------	-----	-----	---------------	-----	----	-----	-----------	------	--	-------

**TOUAREG 2**

Touareg 3.0 Hybrid	7P5	3.0	245	04.10 -	CGEA	6	0,8	PFR8S8EG	94460		PFR8S8EG
Touareg 3.0 Hybrid	7P5	3.0	245	04.10 -	CGFA	6	0,8	PFR8S8EG	94460		PFR8S8EG
Touareg 3.6 FSI	7P5	3.6	206	04.10 -	CGRA	6	0,9	ILZKR7A	1961		ILZKR7A

**TOURAN**

Touran 1.2 TSI	1T3	1.2	77	05.10 -	CBZB	4	0,7	IZFR6P7	97153		IZFR6P7
Touran 1.4 TSI	1T1/1T2	1.4	103	02.06 - 05.10	BMV	4	0,8	PZFR6R8EG	96498		PZFR6R8EG
Touran 1.4 TSI	1T2/1T3	1.4	103	11.08 -	CAVC	4	0,8	PZFR6R8EG	96498		PZFR6R8EG
Touran 1.4 TSI	1T2	1.4	125	11.06 - 11.08	BLG	4	0,9	PZFR6R	5758		PZFR6R
Touran 1.4 TSI	1T2/1T3	1.4	125	11.08 -	CAVB	4	0,9	PZFR6R	5758		PZFR6R
Touran 1.6 TDI	1T3	1.6	66	05.10 -	CAYB	4	█	Y1002AS	8888	57	
Touran 1.6	1T1/1T2	1.6	75	07.03 - 05.05	BGU	4		BKUR6ET-10	2397	24	LPG 1
Touran 1.6	1T1/1T2	1.6	75	06.05 - 05.10	BSE	4		BKUR6ET-10	2397	24	LPG 1
Touran 1.6	1T1/1T2	1.6	75	06.05 - 05.10	BSF	4		BKUR6ET-10	2397	24	LPG 1
Touran 1.6 TDI	1T3	1.6	77	05.10 -	CAYC	4	█	Y1002AS	8888	57	
Touran 1.6 FSI	1T1/1T2	1.6	85	02.03 - 05.04	BAG	4		ZFR6S-Q	6449		ZFR6S-Q
Touran 1.6 FSI	1T1/1T2	1.6	85	05.04 - 05.05	BLP	4		ZFR6S-Q	6449		ZFR6S-Q
Touran 1.6 FSI	1T1/1T2	1.6	85	02.05 - 01.07	BLF	4		ZFR6S-Q	6449		ZFR6S-Q
Touran 1.9 TDI	1T1/1T2	1.9	66	11.04 - 02.06	BRU	4	█	Y-607AS	7560	50	
Touran 1.9 TDI	1T1/1T2	1.9	66	02.06 - 05.10	BXF	4	█	Y-607AS	7560	50	
Touran 1.9 TDI	1T1/1T2	1.9	66	06.06 - 05.10	BXJ	4	█	Y-607AS	7560	50	
Touran 1.9 TDI	1T1	1.9	74	02.03 - 05.04	AVQ	4	█	Y-607AS	7560	50	
Touran 1.9 TDI	1T1/1T2	1.9	77	08.03 - 02.06	BKC	4	█	Y-607AS	7560	50	
Touran 1.9 TDI	1T1/1T2	1.9	77	06.05 - 05.10	BLS	4	█	Y-607AS	7560	50	
Touran 1.9 TDI	1T1/1T2	1.9	77	02.06 - 05.10	BXE	4	█	Y-607AS	7560	50	
Touran 2.0 Ecofuel CNG	1T1/1T2	2.0	80	02.06 - 05.09	BSX	4	0,9	BKR6E	6962	28	LPG 1
Touran 2.0 TDI	1T3	2.0	81	05.10 -	CLCA	4	█	Y1002AS	8888	57	
Touran 2.0 FSI	1T1	2.0	110	10.03 - 05.04	AXW	4		PZFR5N-11T	7742		PZFR5N-11T
Touran 2.0 FSI	1T1	2.0	110	10.03 - 01.04	BHD	4		PZFR5N-11T	7742		PZFR5N-11T
Touran 2.0 FSI	1T1	2.0	110	05.04 - 11.05	BLX	4		PZFR5N-11T	7742		PZFR5N-11T
Touran 2.0 FSI	1T1	2.0	110	05.04 - 11.05	BLY	4	0,9	BKR6E	6962	28	LPG 1
Touran 2.0 FSI	1T1	2.0	110	02.05 - 11.05	BLR	4		PZFR5N-11T	7742		PZFR5N-11T
Touran 2.0 FSI	1T1	2.0	110	11.05 - 01.07	BVY	4		PZFR5N-11T	7742		PZFR5N-11T
Touran 2.0 FSI	1T1	2.0	110	11.05 - 01.07	BVZ	4	0,9	BKR6E	6962	28	LPG 1
Touran 2.0 TDI	1T1/1T2	2.0	100	02.03 - 05.10	AZV	4	█	YE14	7768	48	
Touran 2.0 TDI	1T1/1T2	2.0	103	08.03 - 05.10	BKD	4	█	YE14	7768	48	
Touran 2.0 TDI	1T1/1T2	2.0	103	12.05 - 05.10	BMM	4	█	Y-607AS	7560	50	
Touran 2.0 TDI	1T3	2.0	103	05.10 -	CFHC	4	█	Y1002AS	8888	57	
Touran 2.0 TDI	1T1/1T2	2.0	125	12.05 - 05.10	BMN	4	█	CZ304	9864	55	
Touran 2.0 TDI	1T3	2.0	125	05.10 -	CFJA	4	█	Y1002AS	8888	57	

**VENTO**

Vento 1.4	1H2	1.4	44	11.91 - 07.95	ABD	4		BUR5ET	3377	22	LPG 2
Vento 1.4	1H2	1.4	44	07.95 - 12.97	AEX	4		BUR6ET	3172	1	LPG 2
Vento 1.6	1H2	1.6	55	08.92 - 09.94	ABU	4		BUR6ET	3172	1	LPG 2
Vento 1.6	1H2	1.6	55	10.94 - 07.95	AEA	4		BUR6ET	3172	1	LPG 2
Vento 1.6	1H2	1.6	55	07.95 - 12.97	AEE	4		BUR6ET	3172	1	LPG 2
Vento 1.6	1H2	1.6	74	10.94 - 12.95	AEK	4		BKUR5ET	2789	29	LPG 1
Vento 1.6	1H2	1.6	74	01.96 - 10.00	AFT	4		BKUR6ET-10	2397	24	LPG 1

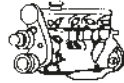

Code *l* kW

Cyl.



Stock-No.



LPG/CNG

**VW  
VENTO**

Vento 1.8	1H2	1.8	55	07.91 - 10.00	AAM	4		BUR5ET	3377	22	LPG 2
Vento 1.8	1H2	1.8	66	11.91 - 07.95	ABS	4		BUR6ET	3172	1	LPG 2
Vento 1.8	1H2	1.8	66	10.94 - 10.00	ADZ	4		BUR6ET	3172	1	LPG 2
Vento 1.9 SDI	1H2	1.9	47	07.95 - 02.99	AEY	4	☑	Y-732J	5605	4	
Vento 1.9 D	1H2	1.9	48	11.91 - 08.98	1Y	4	☑	Y-918J	6285	2	
Vento 1.9 TD	1H2	1.9	55	11.91 - 08.98	AAZ	4	☑	Y-918J	6285	2	
Vento 1.9 TDI	1H2	1.9	66	07.93 - 07.96	1Z	4	☑	Y-732J	5605	4	
Vento 1.9 TDI	1H2	1.9	66	07.96 - 06.00	AHU	4	☑	Y-732J	5605	4	
Vento 1.9 TDI	1H2	1.9	66	05.96 - 12.01	ALE	4	☑	Y-732J	5605	4	
Vento 1.9 TDI	1H2	1.9	81	02.96 - 08.99	AFN	4	☑	Y-732J	5605	4	
Vento 2.0	1H2	2.0	85	11.91 - 09.94	2E	4		BUR6ET	3172	1	LPG 2
Vento 2.0	1H2	2.0	85	10.94 - 05.96	ADY	4		BUR6ET	3172	1	LPG 2
Vento 2.0	1H2	2.0	85	07.95 - 12.01	AGG	4		BUR6ET	3172	1	LPG 2
Vento 2.0	1H2	2.0	85	04.97 - 04.00	AKR	4		BUR6ET	3172	1	LPG 2
Vento 2.8 VR6	1H2	2.8	128	01.92 - 06.95	AAA	6		BKR5EKU	3964		

**WARTBURG AWE**

1.3		1.3	43	09.88 - 05.91	VW	4	0,7	BP6ES	7811	4	LPG 2
-----	--	-----	----	---------------	----	---	-----	-------	------	---	-------

**WIESMANN**

Coupè GT MF4		4.8	270	09.05 -	N62 B48	8	1,1	IZFR6H11	4294		IZFR6H11
Coupè GT MF5		5.0	373	07 -	S85 B50	10		LKR8AP	4471		LKR8AP
Roadster MF28		2.8	142	95 -	M52 B28	6		BKR6EK	2288	20	LPG 1
Roadster MF3		3.2	236	95 - 11.01	S50 B32	6	0,7	PKR7A	3641		PKR7A
Roadster MF3		3.2	252	12.01 -	S54 B32	6		DCPR8EKP	7415		
Roadster MF4-S		4.0	309	03.09 -	S65 B40	8		LKR8AP	4471		LKR8AP

# Conversion Chart

## Vergleichsliste

## Tableau de comparaison thermique

## Tabla de conversión equivalencias

## Jämförelsetabell

## Převodní tabulky

**Note:** This chart is furnished as a guide. Due to differences in design, materials, etc., plugs produced by various manufacturers do not have exactly the same heat range. See recommendations sections for specific engine application.

**Anmerkung:** Diese Liste dient nur zur Information. Wegen der Unterschiede von Konstruktion, Werkstoffen usw. haben die Zündkerzen von verschiedenen Herstellern keinen miteinander übereinstimmenden Wärmebereich. Siehe unsere Empfehlungen für die richtige Anwendung der Zündkerzen.

**Notes:** Cette liste est donnée comme guide. A cause de la différence en dessin, matériels etc., les bougies d'allumage produites par divers fabricans n'ont pas exactement la même gamme thermique. Voir section d'affectations pour utilisation exacte.

**Notas:** Este cuadro se sirve de quia. Bujías que se producen por varios fabricantes no poseen exactamente el mismo alcance térmico debido a las diferencias en diseño, materiales etc. Véase sección de aplicaciones para el uso correcto.

**Observera:** Denna tabell är endast avsedd som vägledning. På grund av avvikelser i utförande, material m.m. kan tändstift av olika fabrikat ej ha exakt samma värmetal. Se rekommendations-tabellen för respektive motor.

**Upozornění:** Převodní tabulky slouží pouze pro srovnávací účely. Zapalovací svíčky od různých výrobců nemají kvůli rozdílné konstrukci, použitému materiálu apod. srovnatelný rozsah tepelných hodnot. Pro správný výběr zapalovací svíčky je třeba se řídit doporučeními firmy NGK v aplikačních tabulkách tohoto katalogu.



ACDelco	→ NGK	V-Line
41-101	ITR4A15	
41-600	TR55IX	
41-601	BPR6ES	2
41-602	FR5	
41-603	FR4	
41-606	TR55	
41-608	FR45	
41-610	FR4	
41-611	FR45	
41-627	BKR4E-11	
41-628	FR4	
41-812	TR6IX	
41-900	TR5	
41-902	TR55	
41-904	TR5	
41-905	UR4	
41-906	TR5	
41-907	TR5	
41-908	BPR5EFIX-13P	
41-910	TR5	
41-913	TR55	
41-919	TR55	
41-921	TR55	
41-928	TR55-1	
41-929	TR55	
41-932	TR55	
41-933	PTR4B-15	
41-936	TR55	
41-940	TR55	
41-942	TR55	
41-943	TR55	
41-947	TR55	
41-948	TR4IX	
41-950	PTR5C-13	
41-952	BPR5EFIX-13P	
41-963	PTR5C-13	
41-974	PZTR5A-15	
41-983	PZTR5A-15	
41-987	PTR5C-13	
41 F	B6HS-10	
41 TS	BP6FS	
41 XL	B9ES	
41 XLS	BP7ES	
42 F	B6HS	
42 FF	B6HS	
42 FS	BP6HS	18
42 S	BP6S	
42 TS	BP6FS	
42 XL	B8ES	
42 XLS	BP6ES	4
43 F	B6HS	
43 FFS	BP6HS	18

ACDelco	→ NGK	V-Line
43 FS	BP6HS	18
43 N	B7ES	
43 S	BP6S	
43 TS	BP6FS	
43 XL	B7ES	
43 XLS	BP6ES	4
44	B6S	
44 F	B5HS	
44 FF	B5HS	
44 FFS	BP5HS	
44 N	B6ES	
44 NS	BP5ES	8
44 S	BP5S	
44 TS	BP5FS	
44 XL	B6ES	
44 XLO	BP5ES	8
44 XLS	BP5ES	8
45	B-4	
45 F	B5HS	
45 FF	B5HS	
45 FFS	BP5HS	
45 L	B-4L	
45 NS	BP5ES	8
45 S	BP5S	
45 TS	BP4FS	
45 XL	B6ES	
45 XLS	BP5ES	8
46	B-4	
46 F	B5HS	
46 FF	B5HS	
46 FFS	BP5HS	
46 N	B5ES	
46 S	BP5S	
46 TS	BP4FS	
46 XL	B5ES	
46 XLS	BP4ES	
47 FF	B-4H	
47 S	BP-4	
47 XL	B4ES	
48	B-4	
83 CTS	AP6FS	
83 TS	AP6FS	
84 T	A6FS	
84 TS	AP5FS	
85 TS	AP5FS	
86 TS	AP5FS	
40 TS	BP7FS	
412 XLS	BP7ES	
414 XLS	BP6ES	4
420 Z	B-4H	
422 Z	B5HS	
425 F	B6HS	



ACDelco	→ NGK	V-Line
425 Z	B6HS	
426 FS	BP6HS	18
430 Z	B7HS	
436 XLS	BP9ES	
438 XLS	BP8ES	
440 T	B7FS	
440 XLS	BP8ES	
445 Z	B8HS	
B 43	B6S	
B 44 FS	BP5HS	
B 44 S	BP5S	
B 45	B-4	
B 4021	B6S	
B 4031	B-4	
C 41	B7S	
C 42 CFS	BP6HS	18
C 42 CLTS	BP6EFS	5
C 42 CXLS	BP6ES	4
C 42 LTS	BP6EFS	5
C 42 N	B7ES	
C 42 XLS	BP5ES	8
C 43	B6S	
C 43 CXLS	BP6ES	4
C 43 L	B-6L	
C 43 N	B6ES	
C 44	B6S	
C 44 N	B6ES	
C 44 NS	BP5ES	8
C 44 S	BP5S	
C 44 XL	B6ES	
C 45	B-4	
C 45 L	B-4L	
C 46	B-4	
C 47	B-4	
C 47 W	B-4	
C 49	B-2	
C 73	G-2Z	
C 75	G-2Z	
C 81	AB-8	
C 82	AB-7	
C 82 T	A7FS	
C 83	AB-7	
C 83 T	A6FS	
C 84 T	A6FS	
C 85	AB-6	
C 85 TS	AP5FS	
C 86	AB-6	
C 87	AB-6	
C 88	AB-2	
C 88 L	AB-2	
C 421	B6S	
CFR 1 CLS	BCPR7ES	

ACDelco	→ NGK	V-Line
CFR 2 CLS	BKR6ES	28
CR 42 CFS	BPR6FS	
CR 42 CXLS	BPR6ES	2
CR 42 N	BR7ES	
CR 43	BR6S	
CR 43 CXLS	BPR6ES	2
CR 43 K	BR6S	
CR 43 N	BR6ES	
CR 43 S	BP6S	
CR 43 TS	BPR5FS-11	
CR 43 TSM	BPR5FS-11	
CR 44 N	BR6ES	
CR 44 NS	BPR5ES	6
CR 44 TS	BPR5FS-11	
CR 45 TS	UR4	
CR 83 T	AR6FS	
CS 40	BM7A	
CS 41	BM7A	
CS 41 T	BM7F	
CS 42	BM7A	
CS 42 S	BM7A	
CS 42 T	BM6F	
CS 45	BM6A	
CS 45 T	BM6F	
CS 49	BM4A	
CSR 45	BMR6A	
FR 2 LS	BKR6ES	28
FR 2 LSK	BKR6ES	28
FR 3 CLS	BKR5ES	35
FR 3 CLS 6	BKR5ES-11	33
FR 3 LM	ZFR5A-11	
FR 3 LS	BKR5ES	35
FR 3 LS 6	BKR5ES-11	33
FR 3 LSJ	BKR4E-11	
FR 3 LSK	BKR5ES	35
FR 4 LE	ZFR4F-11	
FR 4 LSJ	BKR4E-11	
FR 5 LS	BKR5ES	35
LM 46	B4-LM	
LM 49	B4-LM	
M 40 FF	B9HS	
M 40 FFX	B9HS-10	
M 41 FF	B8HS	
M 41 K	B8S	
M 42 FF	B7HS	
M 42 K	B7S	
M 43 FF	B6HS	
M 43 S	BP6S	
M 44 B	B6S	
M 44 C	B6S	
M 44 L	B-6L	
M 45	B-4	



ACDelco	→ NGK	V-Line
M 45 FF	B5HS	
M 47	B-4	
M 86	AB-6	
MB 42 K	B6S	
MC 41	B8S	
MC 41 F	B8HS	
MC 42	B8S	
MC 42 F	B7HS	
MC 44	B7S	
MC 104 F	C6HSA	
MC 121 F	D10HS	
MC 122 F	D8HA	
MC 124 FS	D6HA	
MR 42 K	BR6S	
MR 42 LTS	BPR6EFS	7
MR 43 LTS	BPR6EFS	7
MR 43 T	BR6FS	
MR 44 C	BR6S	
MR 44 T	BR5FS	
MR 45	B-4	
R 41 CF	BR7HS	
R 41 CXL	BR9ES	
R 41 CXLS	BPR7ES	19
R 41 TS	BPR6FS	
R 42 CF	BR6HS	
R 42 CFS	BPR6HS	3
R 42 CLTS	BPR6EFS	7
R 42 CT	BR6FS	
R 42 CTS	BPR6FS	
R 42 CXL	BR8ES	
R 42 CXLS	BPR6ES	2
R 42 FS	BPR6HS	3
R 42 LTS	BPR6EFS	7
R 42 LTSM	BPR5EFS-13	
R 42 S	BP6S	
R 42 T	BR6FS	
R 42 TS	BPR6FS	
R 42 TSM	BPR6FS	
R 42 TX	BR6FS	
R 42 XL	BR8ES	
R 42 XLS	BPR6ES	2
R 42 XLSM	ZGR5C	
R 43	BR6S	
R 43 C	BR6S	
R 43 CFS	BPR6HS	3
R 43 CNTSE	TR5-1	
R 43 CS	BP6S	
R 43 CT	BR6FS	
R 43 CTS	BPR6FS	
R 43 CTS 6	BPR6FS	
R 43 CXL	BR7ES	
R 43 CXLS	BPR6ES	2

ACDelco	→ NGK	V-Line
R 43 FS	BPR6HS	3
R 43 LTS	BPR6EFS	7
R 43 LTSE	TR4	
R 43 LTSX	BPR6EFS-13	
R 43 N	BR7ES	
R 43 NTSE	TR5-1	
R 43 S	BP6S	
R 43 T	BR6FS	
R 43 TS	BPR6FS	
R 43 TSK	BPR6FS	
R 43 TSX	BPR6FS	
R 43 TX	BR6FS	
R 43 XL	BR7ES	
R 43 XLS	BPR6ES	2
R 44	BR6S	
R 44 CF	BR5HS	
R 44 CNTSE	TR5-1	
R 44 CXL	BR6ES	
R 44 CXLS	BPR5ES	6
R 44 F	BR5HS	
R 44 LTS	BPR5EFS	
R 44 LTS 6	BPR5EFS-13	
R 44 LTS 6K	BPR5EFS-13	
R 44 LTSM	TR4	
R 44 LTSM 6	TR4	
R 44 N	BR6ES	
R 44 NS	BPR5ES	6
R 44 NTSE	TR5-1	
R 44 S	BP5S	
R 44 T	BR5FS	
R 44 TS	BPR5FS	
R 44 TSX	BPR5FS-15	
R 44 TX	BR5FS	
R 44 XL	BR6ES	
R 44 XLS	BPR5ES	6
R 44 XLS 6	BPR4ES-13	
R 44 XLSE	ZGR5C	
R 44 XLSM	ZGR5C	
R 45	BR6S	
R 45 LTS 6	BPR5EFS-13	
R 45 LTS 6K	BPR5EFS-13	
R 45 NS	BPR5ES	6
R 45 NSX	BPR5ES-13	
R 45 NTSE	TR5-1	
R 45 S	BP5S	
R 45 T	BR5FS	
R 45 TS	BPR4FS	
R 45 TSX	BPR4FS-15	
R 45 XL	BR6ES	
R 45 XLS	BPR5ES	6
R 46	BR6S	
R 46 LTS	BPR5EFS	





ACDelco	→ NGK	V-Line
R 46 N	BR5ES	
R 46 S	BP-4	
R 46 SZ	XR45IX	
R 46 T	BR5FS	
R 46 TS	BPR4FS	
R 46 TSX	BPR4FS-15	
R 46 TX	BR5FS	
R 46 XL	BR5ES	
R 46 XLS	BPR4ES	
R 47 S	BP-4	
R 83 CT	AR6FS	
R 83 CTS	APR6FS	
R 83 TS	APR6FS	
R 84 TS	APR5FS	
R 85 TS	APR5FS	
R 415 TS	BPR6FS	
R 425 LTS	BPR6EFS	7
R 425 TS	BPR6FS	
R 426 FS	BPR6HS	3
S 40 F	B9HS	
S 40 FR	BR9HS	
S 40 XL	B10ES	
S 40 XLG	B9ECS	
S 40 XLR	BR8ES	
S 41 F	B8HS	
S 41 FG	B7HCS	
S 41 FR	BR8HS	
S 41 XL	B9ES	
S 41 XLG	B8ECS	
S 41 XLR	BR9ES	
S 42	B7S	
S 42 F	B7HS	
S 42 FR	BR7HS	
S 42 XL	B8ES	
S 42 XLR	BR8ES	
S 43 XL	B7ES	
S 43 XLR	BR7ES	
S 44	B6S	
S 44 F	B5HS	
S 44 XL	B6ES	
S 45 F	B5HS	
S 46	B-4	
S 81 F	AB-8	
S 82 F	AB-8	
S 83 F	AB-7	
S 85 F	AB-6	
S 102 F	C7HSA	
S 104 F	C6HSA	
S 121 F	D8HA	
S 121 XL	D8EA	
S 122 F	D8HA	
S 123 XL	D7EA	

ACDelco	→ NGK	V-Line
S 124 FS	D6HA	
S 404 XLG	B10EG	
S 408 XLG	B9EG	
SB 41	B7S	
SN 46	B-4	
SV 4 XL	BUE	
SV 41 XL	BUE	
TC 42	B8S	
TC 45	B6S	
TC 49	B-2	
TC 81	AB-8	
TC 82	AB-8	
TC 83	AB-7	
TC 85	AB-6	
TC 86	AB-6	
V 40 FFK	BUHW-2	
V 40 FFM	BUHW	
V 40 FFS	BUH	
VB 40 FFM	BUHXW-1	
VR 40 FFK	BUZHW-2	
VR 40 FFM	BUZHW	
<b>ALFA ROMEO =&gt; FIAT Group</b>		
<b>AMG =&gt; MERCEDES</b>		
ASTON MARTIN	→ NGK	V-Line
723 116	BCPR6E	12
<b>AUDI =&gt; VW Group</b>		
AUTOLITE / TUNER	→ NGK	V-Line
12	BP7FS	
13	BP6FS	
14	BP6FS	
15	BP5FS	
16	BP4FS	
23	BPR6FS	
24	BPR6FS	
25	BPR5FS	
26	BPR4FS-15	
27	BPR4FS-15	
32	AP7FS	
33	AP6FS	
34	AP6FS	
35	AP5FS	
36	AP5FS	
37	AP5FS	
43	APR6FS	
44	APR6FS	



AUTOLITE / TUNER	→ NGK	V-Line
45	APR5FS	
46	APR5FS	
52	BP7ES	
53	BP6ES	4
54	BP6ES	4
55	BP5ES	8
56	BP5ES	8
57	BP4ES	
62	BP7ES	
63	BPR6ES	2
64	BPR6ES	2
65	BPR5ES	6
66	BPR5ES	6
67	BPR4ES	
73	BP6S	
74	BP6S	
75	BP5S	
76	BP5S	
77	BP-4	
84	BP6S	
85	BP5S	
86	BP-4	
87	BP-4	
94	BP7EFS	
102	BP7EFS	
103	BPR6EFS	7
104	BPR6EFS	7
105	BPR5EFS	
106	BPR5EFS	
112	A9FS	
113	A7FS	
115	A6FS	
117	A6FS	
124	AR6FS	
135	B7FS	
136	BR6FS	
143	BR6FS	
144	BR6FS	
145	BR6FS	
146	BR5FS	
147	BR5FS	
156	AP5FS	
166	APR5FS	
175	BP5S	
203	BPR6FS	
215	B-6L	
216	B-6L	
217	B-4L	
218	B-4L	
235	BM6A	
245	BMR6A	
253	BM7A	

AUTOLITE / TUNER	→ NGK	V-Line
254	BM6A	
255	BM6A	
258	BM4A	
273	BP6HS	18
274	BP6HS	18
275	BP5HS	
276	BP5HS	
283	BPR7HS	
284	BPR6HS	3
292	B8S	
294	B6S	
295	B-4	
297	B-4	
298	B-2	
302	BR6S	
303	BR6S	
304	BR6S	
306	B-4	
308	B-2	
312	B8S	
313	B7S	
314	B6S	
315	B6S	
316	B6S	
317	B-4	
318	B-2	
344	AR6FS	
353	B8S	
354	B6S	
355	B6S	
356	B-4	
357	B-4	
358	B-2	
363	BR6S	
372	AB-8	
373	AB-7	
374	AB-7	
375	AB-6	
376	AB-6	
377	AB-6	
378	AB-6	
379	AB-2	
386	AB-6	
393	B7ES	
394	B6ES	
395	B5ES	
396	B5ES	
397	B5ES	
398	B4ES	
402	BR8ES	
403	BR6ES	
404	BR6ES	



AUTOLITE / TUNER	→ NGK	V-Line
405	BR5ES	
406	BR5ES	
411	B9HS	
413	B7HS	
414	B6HS	
415	B5HS	
416	B5HS	
417	B-4H	
424	B6HS	
425	BR5HS	
426	BR5HS	
436	B-6L	
437	B-4L	
456	B4-LM	
458	B2-LM	
472	B9EFS	
483	BR7EFS	
494	B-6L	
495	B-6L	
497	B-4L	
515	BP5HS	
516	BP5HS	
517	BP-4H	
535	B5HS	
536	B-4H	
584	AR6FS	
603	BPR6EFS-13	
604	BPR6EFS-13	
605	BPR6EFS-13	
646	BPR5ES-13	
664	BPR6FS	
665	BPR5FS-15	
666	BPR4FS-15	
667	BPR4FS-15	
683	BR6FS	
684	BR6FS	
685	BR6FS	
687	BR5FS	
723	BPR6FS	
724	BPR6FS	
725	BPR5FS-11	
726	BPR4FS	
727	BPR4FS-11	
744	APR5FS	
746	APR5FS	
747	APR5FS	
763	TR5-1	
764	BPR6EFS	7
765	BPR5EFS	
766	BPR5EFS	
784	AR6FS	
804	AR6FS	

AUTOLITE / TUNER	→ NGK	V-Line
865	BPR5EFS	
884	BPR6EFS-13	
915	ZGR5C	
925	ZGR5C	
935	BPR5ES	6
945	BPR5ES	6
985	ZFR4F-11	
996	B-6L	
2272	AB-7	
2413	B10EGP	
2414	B10EG	
2415	B9EG	
2416	B8EG	
2417	B7ECS	
2543	TR5-1	
2544	TR5-1	
2545	TR5-1	
2546	TR5-1	
2585	BPR5ES	6
2592	B10ES	
2593	B9ES	
2594	B9ES	
2611	B10ES	
2612	B9ES	
2613	B9ES	
2614	B8ES	
2615	B7ES	
2616	B6ES	
2634	B9HS-10	
2635	B8HS	
2636	B7HS	
2652	B9HS-10	
2653	B7HS	
2654	B7HS	
2655	B6HS	
2656	B5HS	
2675	B-6L	
2676	B-6L	
2695	AB-8	
2696	AB-7	
2697	AB-6	
2715	D8HA	
2716	D6HA	
2735	D6HA	
2755	D8EA	
2772	AB-8	
2775	AB-6	
2794	C8HSA	
2795	C7HSA	
2796	C6HSA	
2852	BUH	
2872	BUHW	



AUTOLITE / TUNER	→ NGK	V-Line
2892	BUHX	
2932	BUE	
2954	BM7F	
2956	BM6F	
2974	BPM7A	
2976	BPMR7A	
3012	B8S	
3013	B7S	
3014	B6S	
3017	B-4	
3035	AB-6	
3036	BPR4FS-15	
3055	A6FS	
3074	G-2Z	
3075	G-2Z	
3116	AB-6	
3203	BPR6ES	2
3204	BPR6ES	2
3205	BPR5ES	6
3206	BPR5ES	6
3207	BPR5ES	6
3224	BP6S	
3225	BP5S	
3226	BP5S	
3227	BP5S	
3243	BPR6EFS	7
3244	BPR6EFS	7
3245	BPR5EFS	
3246	BPR5EFS	
3264	B7FS	
3265	BR6FS	
3266	BR5FS	
3267	BR5FS	
3286	APR6FS	
3303	BPR6FS	
3325	B-6L	
3327	B-4L	
3345	BMR7A	
3364	BPR6HS	3
3382	BR6S	
3383	BR6S	
3384	BR6S	
3386	BR6S	
3388	BR6S	
3404	AR6FS	
3423	B8S	
3426	BR6S	
3462	BR7ES	
3463	BR6ES	
3464	BR6ES	
3465	BR5ES	
3466	BR5ES	

AUTOLITE / TUNER	→ NGK	V-Line
3485	BR5HS	
3486	BR5HS	
3507	B-6L	
3565	BPR5EFS	
3586	BPR5ES-13	
3604	BPR5FS-15	
3605	BPR4FS-15	
3606	BPR4FS-15	
3607	BPR4FS-15	
3624	BR6FS	
3625	BR6FS	
3627	BR5FS	
3666	B4-LM	
3684	BR7HS	
3686	BR6HS	
3702	BR9ES	
3703	BR9ES	
3704	BR8ES	
3705	BR6ES	
3706	BR6ES	
3724	BPR5EFS	
3885	ZGR5C	
3896	ZGR5C	
3922	BCPR7ES	
3924	BKR6ES	28
3926	BKR5ES	35
3954	D8EA	
3964	DR8ES-L	
3985	BPR5FS-15	
4043	BPR6ES-11	13
4052	B9ES	
4053	B9ES	
4054	B8ES	
4055	B7ES	
4056	B6ES	
4062	BR9ES	
4063	BR9ES	
4092	B7HS	
4093	B7HS	
4113	BP6HS	18
4114	BP6HS	18
4123	BPR6HS	3
4132	D8EA	
4143	DR8ES-L	
4152	DP9EA-9	
4153	DP8EA-9	
4162	DPR7EA-9	
4163	DR8ES-L	
4164	D7EA	
4173	D8HA	
4193	C7HSA	
4203	CR7HS	



AUTOLITE / TUNER	→ NGK	V-Line
4251	BP8ES	
4252	BP7ES	
4253	BP6ES	4
4263	BPR6ES	2
4265	BPR5ES	6
4275	BP5S	
5143	TR5-1	
5224	BKR5E	35
9062	BUR6ET	1
9063	BUR6ET	1
9064	BP5ET	
9921	BCPR6ET	
AP 63	PFR6B	
APP 392 411	BKR5EP-11	

**BENTLEY => VW Group → NGK**

BERU	→ NGK	V-Line
12-5 DU	D7EA	
12 ZR-6 SP2	PLZKBR7A-G	
12 ZR-6 SP03	PLZKBR7A-G	
12 ZR-6 SPP21	PLZKBR7A-G	
12 ZR-7 SP03	PLZKBR7A-G	
14-2 AS1	B9HCS	
14-3 A1	B8HS	
14-3 AS1	BR8HIX	
14-3 AU	B8HS	
14-3 CS1	BR8EIX	
14-3 DP2	BR8EIX	
14-4 A1	B8HS	
14-4 A2	B7HS	
14-4 AS1	BR8HIX	
14-4 AU	B7HS	
14-4 B2	BP7HS	
14-4 C1	B8ES	
14-4 C2	B7ES	
14-4 CS1	BR8EIX	
14-4 DP0	BP7ES	
14-5 A	B7HS	
14-5 AU	B7HS	
14-5 B	BP7HS	
14-5 BU	BP7HS	
14-5 C	B7ES	
14-5 CS	B7ECS	
14-5 D	BP7ES	
14-5 D1	BP7ES	
14-5 DP1	BP7ES	
14-5 DTU	BUR6ET	1
14-5 DU	BP7ES	
14-5 DU0	BP7ES	
14-5 E	B7S	
14-5 F	BP6S	

BERU	→ NGK	V-Line
14-6 B	BP6HS	18
14-6 BU	BP6HS	18
14-6 C	B6ES	
14-6 D	BP6ES	4
14-6 D1	BP6ES	4
14-6 DP0	BP6ES	4
14-6 DTU	BUR6ET	1
14-6 DU	BP6ES	4
14-6 DU0	BP6ESZ	
14-7 A	B6HS	
14-7 AU	B6HS	
14-7 B	BP6HS	18
14-7 BU	BP6HS	18
14-7 C	B6ES	
14-7 CU	B6ES	
14-7 D	BP6ES	4
14-7 DTU	BUR6ET	1
14-7 DU	BP6ES	4
14-7 DU0	BP6ESZ	
14-7 E	B6S	
14-7 F	BP6S	
14-8 A	B5HS	
14-8 AU	B5HS	
14-8 B	BP5HS	
14-8 BU	BP5HS	
14-8 C	B5ES	
14-8 C1	B6ES	
14-8 D	BP5ES	8
14-8 DTU	BP5ET-10	
14-8 DU	BP5ES	8
14-8 DU0	BP5ESZ	
14-8 E	B-4	
14-8 F	BP5S	
14-8 LUR	ZGR5A	15
14-9 C	B5ES	
14-9 D	BP5ES	8
14-9 DTU	BP5ET	
14-9 DU	BP5ES	8
14-9 DU0	BP5ESZ	
14-9 EU0	B4-LM	
14-10 A	B-4H	
14-10 B	BP4HS	
14-10 C	B4ES	
14-10 D	BP4ES	
14-10 E	B-4	
14-10 F	BP-4	
14 F-5 DU	BCP7ES	
14 F-6 DPUR021	PFR7Q	
14 F-6 DSR	BKR6ES	28
14 F-6 DTU	BCP6ET	
14 F-6 DU0	BCP6ES	17
14 F-6 DUOR	BKR6ES	28





<b>BERU</b>	<b>→ NGK</b>	<b>V-Line</b>
14 F-7 DPUR02	PFR6Q	37
14 F-7 DPURX2	IFR6D10	
14 F-7 DU	BCP6ES	17
14 F-7 DU0	BCP6ES	17
14 F-7 DUOR	BKR6ES	28
14 F-7 HPURX2	PZFR5D-11	34
14 F-7 HUR2	ZFR5P-G	
14 F-7 LDUR	BKR6EK	20
14 F-7 LDUR4	BKR6EK	20
14 F-8 DU	BCP5ES	16
14 F-8 DU0	BCP5ES	16
14 F-8 DU4	BCP5ES	16
14 F-8 DUR	BKR6EZB	
14 F-8 LDUSR	BKR6EK	20
14 F-8 LUR	ZFR5F	
14 F-9 DU0	BCP5ES	16
14 FGH-6 DTUR	BKUR6ET	27
14 FGH-7 DPURX2	IFR6D10	
14 FGH-7 DTURX	BKUR6ET-10	24
14 FGH-8 DPURX2	IFR5D10	
14 FGH-8 DTURW	BKUR5ET	29
14 FGH-8 DTURX0	BKUR5ET-10	
14 FGR-6 DDU	BKR6EKUB	
14 FGR-7 CTU	BCPR7ET	
14 FR-5 DTU	BCPR7ET	
14 FR-5 DU	BCPR7ES	
14 FR-6 DU	BKR6ES	28
14 FR-6 DUX	BKR6ES-11	14
14 FR-6 LDU	BKR6EK	20
14 FR-6 LDU3	BKR6EKE	
14 FR-6 LDUW	BKR6EKC	26
14 FR-7 DQUP7	BKR6EQUP	30
14 FR-7 DU	BKR6ES	28
14 FR-7 DUX	BKR6ES-11	14
14 FR-7 KPU	BKR6EP-8	
14 FR-7 KPUV	BCPR6EP-11	
14 FR-7 KPUX	BCPR6EP-11	
14 FR-7 KU	BKR6EY	
14 FR-7 KU0	BKR6EYA	
14 FR-7 KUOX	BKR6EYA-11	
14 FR-7 LDU	BKR6EK	20
14 FR-7 LUX	ZFR6F-11	
14 FR-7 MU2	LFR6B	
14 FR-8 DU	BKR5ES	35
14 FR-8 DUX	BKR5ES-11	33
14 FR-8 HU	BCRE527Y	
14 FR-8 KU	BKR5EY	
14 FR-8 KUOU	BKR5EYA-11	39
14 FR-8 KUO	BKR5EYA	
14 FR-8 LDUOX4	BKR5EK	23
14 FR-8 LU2	ZFR5F-11	
14 G-8 DTU	BUR5ET	22

<b>BERU</b>	<b>→ NGK</b>	<b>V-Line</b>
14 GH-7 DTUR	BUR6ET	1
14 GH-8 DTUR	BUR5ET	22
14 GH-8 DTURX	BUR5ET-10	21
14 GR-8 DTU	BPR5EKU	
14 K-5 DU	BP7EFS	
14 K-5 DU0	BP7EFS	
14 K-6 D	BP6EFS	5
14 K-6 DU	BP6EFS	5
14 K-6 DU0	BP6EFS	5
14 K-7 D	BP6EFS	5
14 K-7 DU	BP6EFS	5
14 K-7 DU0	BP6EFS	5
14 K-8 DU	BP5EFS	
14 K-8 DU0	BP5EFS	
14 K-9 DU	BP5EFS	
14 K-9 DU0	BP5EFS	
14 KGR-6 KQU	BUR6EFSZ	
14 KR-6 BU	BPR6FS	
14 KR-6 DU	BPR6EFS	7
14 KR-7 DU	BPR6EFS	7
14 KR-7 DUX	BPR6EFS-13	
14 KR-8 DPU0V	TR55IX	
14 KR-8 MPX	PTR5A-13	25
14 KR-8 MUV	PTR5A-13	25
14 KR-8 STUX	LTR6B-10T	
14 R-5 DU	BPR7ES	19
14 R-6 B	BPR6HS	3
14 R-6 BU	BPR6HS	3
14 R-6 D	BPR6ES	2
14 R-6 DU	BPR6ES	2
14 R-6 DUX	BPR6ES-11	13
14 R-7 B	BPR6HS	3
14 R-7 BU	BPR6HS	3
14 R-7 CU	BR6ES	
14 R-7 D	BPR6ES	2
14 R-7 DU	BPR6ES	2
14 R-7 DUX	BPR6ES-11	13
14 R-8 DU	BPR5ES	6
14 R-8 DUX	BPR5ES-11	
14 R-9 DU	BPR5ES	6
14 R-9 EU0	BR4-LM	
14 R-11 F	BP-4	
14 S-5 A	BL-6H	
14 S-5 F	BPM7A	
14 S-7 A	BL-6H	
14 S-7 F	BPM6A	
14 S-8 F	BPM6A	
14 SR-6 F	BPMR6A	
14 X-AU	B6HS	
14 Z-2 C1	BR9EIX	
14 Z-3 A1	B9HS	
14 Z-3 AU	B9HS	



<b>BERU</b>	<b>→ NGK</b>	<b>V-Line</b>
14 Z-3 C1	B9ES	
14 Z-3 CU	B9ES	
14 Z-4 AU	B8HS	
14 Z-6 A2	B6HS	
14 Z-7 AU	B7HS	
18-4 A1	AB-7	
18-4 A2	AB-7	
18-5 A	AB-7	
18-5 AS	AB-7	
18-5 AU	AB-7	
18-7 A	AB-6	
18-7 AU	AB-7	
18-8 A	AB-6	
18-10 A	AB-6	
18-10 AU	AB-6	
18-12 B	AB-2	
18 K-6 BU	AP6FS	
18 K-7 B	AP6FS	
18 K-7 BU	AP6FS	
18 K-8 B	AP5FS	
18 K-8 BU	AP5FS	
18 K-12 B	AP5FS	
45/18	AP5FS	
95/14	B-4H	
95/14/3	B4ES	
95/14/3A	BP4ES	
95/14/5	B-4	
95/14/5A	BP-4	
95/14A	BP4HS	
95/18	AB-6	
125/14/3	B5ES	
125/14/3A	BP5ES	8
145/14	B5HS	
145/14/3	B5ES	
145/14/3A	BP5ES	8
145/14/5	B-4	
145/14/5A	BP5S	
145/14/5AMX	BPM6A	
145/18	AB-6	
145/18K	AP5FS	
145/1A	BP5HS	
160/14/3	B6ES	
175/14	B6HS	
175/14/3	B6ES	
175/14/3A	BP6ES	4
175/14/5	B6S	
175/14/5A	BP6S	
175/14/5AMX	BPM6A	
175/14/UK4	BL-6H	
175/14A	BP6HS	18
175/18	AB-6	
175/18K	AP6FS	

<b>BERU</b>	<b>→ NGK</b>	<b>V-Line</b>
190/14 Z	B6HS	
200/14/3	B6ES	
200/14/3A	BP6ES	4
200/14/3K	BP6EFS	5
200/14A	BP6HS	18
215/14/3A	BP6ES	4
225/14	B7HS	
225/14/3	B7ES	
225/14/3A	BP7ES	
225/14/3S	B7ECS	
225/14/5	B7S	
225/14/5A	BP6S	
225/14/5AMX	BPM7A	
225/14/UK4	BL-6H	
225/14A	BP7HS	
225/18	AB-7	
225/18S	AB-7	
230/14/3A	BP7ES	
235/14/3P	BP7ES	
240/14	B7HS	
240/14/3	B7ES	
240/14 A	BP7HS	
240/14 S	BR8HIX	
240/18	AB-7	
260/14	B8HS	
260/14/3	B8ES	
260/14 S	BR8HIX	
260/18	AB-8	
265/14/3P	BR8EIX	
280/14	B8HS	
280/14/3S	BR8EIX	
280/14/3Z	B9ES	
280/14Z	B9HS	
310/14/3Z	BR9EIX	
310/14S	B9HCS	
D 175/14	B6HS	
D 175/14/3	B6ES	
D 200/14/3A	BP6ES	4
D 215/14/3	B7ES	
D 230/14/3A	BP7ES	
RS 16	BPR6HIX	
RS 18	BPR7HIX	
RS 33	BPR5EIX	
RS 35	BPR6EIX	
RS 37	BPR7EIX	
RS 39	BPR7EIX	
Z 1	BP5ES	8
Z 2	BP5ET-10	
Z 3	ZGR5A	15
Z 4	ZFR5F	
Z 5	BCP5ES	16
Z 6	BP5EFS	



<b>BERU</b>	<b>→ NGK</b>	<b>V-Line</b>
Z 7	BP5EFS	
Z 8	BPR5ES	6
Z 9	BPR5ES-11	
Z 10	BP6HS	18
Z 11	BP6ES	4
Z 12	BUR6ET	1
Z 13	BKR6ES	28
Z 14	BKR6EK	20
Z 15	BKR6ES	28
Z 16	BKR6ES-11	14
Z 17	BP6EFS	5
Z 18	BP6EFS	5
Z 19	BPR6HS	3
Z 20	BPR6ES	2
Z 21	BPR6ES-11	13
Z 22	BP6ES	4
Z 23	BKR6ES	28
Z 24	BKR6ES	28
Z 25	BP6EFS	5
Z 26	BPR6EFS	7
Z 27	BPR6ES	2
Z 28	BPR6ES-11	13
Z 29	BCP7ES	
Z 30	BCPR7ES	
Z 31	BP7EFS	
Z 32	AP6FS	
Z 33	AP6FS	
Z 35	D7EA	
Z 37	B9HS	
Z 38	B9ES	
Z 39	B8HS	
Z 40	B7HS	
Z 41	BP7HS	
Z 42	BP7ES	
Z 43	BP7ES	
Z 44	BUR6ET	1
Z 45	BCPR7ET	
Z 46	BP7EFS	
Z 47	BPR7ES	19
Z 48	BP6HS	18
Z 49	BPR6FS	
Z 50	BP6ESZ	
Z 51	BUR6ET	1
Z 52	BCP6ET	
Z 53	BCP6ET	
Z 54	BCP6ES	17
Z 55	BP6EFS	5
Z 56	BP6EFS	5
Z 57	B6HS	
Z 58	B6ES	
Z 59	BR6ES	
Z 60	BCPR7ET	

<b>BERU</b>	<b>→ NGK</b>	<b>V-Line</b>
Z 61	BP6ESZ	
Z 62	BP6ESZ	
Z 63	BCP6ES	17
Z 64	BCP6ES	17
Z 67	BPR6EFS-13	
Z 68	B5HS	
Z 69	BP5ESZ	
Z 70	BP5ESZ	
Z 71	BCP5ES	16
Z 72	BKR5ES	35
Z 73	BKR5ES-11	33
Z 74	BKR5EK	23
Z 75	BUR5ET	22
Z 76	BP5ES	8
Z 77	BP5ESZ	
Z 78	BP5ET	
Z 79	BCP5ES	16
Z 80	BP5EFS	
Z 81	BP5EFS	
Z 82	BPR5ES	6
Z 83	B4-LM	
Z 84	BR4-LM	
Z 85	B6HS	
Z 86	AB-7	
Z 87	AB-7	
Z 88	AB-6	
Z 89	BKUR6ET	27
Z 90	BKUR6ET-10	24
Z 91	BUR6ET	1
Z 92	BUR5ET	22
Z 93	BUR5ET-10	21
Z 94	BPR5EKU	
Z 95	BPR6EFS	7
Z 97	PTR5A-13	25
Z 98	BKR6EK	20
Z 99	BKR6ES-11	14
Z 100	BCP5ES	16
Z 101	BKR6EK	20
Z 103	BP7ES	
Z 104	BP6ES	4
Z 105	BKR6ES	28
Z 106	BPMR6A	
Z 107	BP-4	
Z 112	B-4	
Z 116	BKR6EK	20
Z 118	BP5HS	
Z 121	BKUR5ET-10	
Z 122	IFR5D10	
Z 132	BPM6A	
Z 144	BUR6EFSZ	
Z 145	BKR6EKUB	
Z 148	TR55IX	



BERU	→ NGK	V-Line
Z 149	BCPR6EP-11	
Z 150	BCPR6EP-11	
Z 151	BKR6EP-8	
Z 152	BCRE527Y	
Z 153	BKR5EY	
Z 154	BKR5EYA	
Z 155	BKR6EY	
Z 156	BKR6EYA	
Z 157	BKR6EYA-11	
Z 158	ZFR6F-11	
Z 171	IFR6D10	
Z 176	PZFR5D-11	34
Z 177	PTR5A-13	25
Z 184	LFR6B	
Z 185	PFR7Q	
Z 188	PFR6Q	37
Z 194	BKR6EKE	
Z 200	ZFR5P-G	
Z 203	ZFR5F-11	
Z 222	LTR6B-10T	
Z 227	BKR6EZB	
Z 233	PLZKBR7A-G	
Z 237	BKR6EQUP	30
Z 245	BKR6EKC	26
Z 246	BKUR5ET	29
Z 249	BKR5EYA-11	39
Z 265	BPM7A	
Z 282	IFR6D10	
Z 288	PLZKBR7A-G	
Z 336	PLZKBR7A-G	
0 001 245 700	D7EA	
0 001 325 701	BP5ES	8
0 001 325 704	BP5ESZ	
0 001 325 705	BCP5ES	16
0 001 325 710	BP5ET	
0 001 330 104	BUR5ET	22
0 001 330 112	BUR5ET-10	21
0 001 330 113	BUR5ET	22
0 001 330 116	BKUR5ET-10	
0 001 330 119	BKUR5ET	29
0 001 330 501	BKR6EK	20
0 001 330 702	BP5ES	8
0 001 330 707	BCP5ES	16
0 001 330 709	BP5ET-10	
0 001 330 713	BP5ESZ	
0 001 330 717	ZFR5F	
0 001 330 718	ZGR5A	15
0 001 330 725	BCP5ES	16
0 001 330 726	BP5ESZ	
0 001 330 731	BCP5ES	16
0 001 330 780	BKR6EZB	
0 001 330 904	IFR5D10	

BERU	→ NGK	V-Line
0 001 335 107	BKUR6ET-10	24
0 001 335 108	BUR6ET	1
0 001 335 702	BP6ES	4
0 001 335 707	B6ES	
0 001 335 709	BUR6ET	1
0 001 335 714	BP6ESZ	
0 001 335 721	BCP6ES	17
0 001 335 725	BCP6ES	17
0 001 335 729	BKR6ES	28
0 001 335 732	BKR6EK	20
0 001 335 737	BP6ESZ	
0 001 335 742	ZFR5P-G	
0 001 335 905	IFR6D10	
0 001 335 910	IFR6D10	
0 001 335 911	PZFR5D-11	34
0 001 335 914	PFR6Q	37
0 001 340 103	BKUR6ET	27
0 001 340 702	BP6ES	4
0 001 340 704	BUR6ET	1
0 001 340 706	BCP6ET	
0 001 340 707	BP6ESZ	
0 001 340 716	BCP6ES	17
0 001 340 717	BCP6ET	
0 001 340 723	BKR6ES	28
0 001 340 806	BKR6ES	28
0 001 340 903	BP6ES	4
0 001 340 908	PFR7Q	
0 001 345 702	BP7ES	
0 001 345 704	BUR6ET	1
0 001 345 711	BP7ES	
0 001 345 720	BCP7ES	
0 001 350 903	BP7ES	
0 001 355 700	B9ES	
0 001 400 701	B6HS	
0 001 430 700	BP5HS	
0 001 430 701	B5HS	
0 001 435 700	BP6HS	18
0 001 435 705	B6HS	
0 001 440 700	BP6HS	18
0 001 445 700	BP7HS	
0 001 445 702	B7HS	
0 001 450 702	B8HS	
0 001 455 702	B9HS	
0 001 529 302	B-4	
0 001 625 700	BP5EFS	
0 001 625 702	BP5EFS	
0 001 630 700	BP5EFS	
0 001 630 704	BP5EFS	
0 001 635 700	BP6EFS	5
0 001 635 709	BP6EFS	5
0 001 640 700	BP6EFS	5
0 001 640 704	BP6EFS	5







<b>BMW</b>	<b>→ NGK</b>	<b>V-Line</b>
12 12 7 550 011 02	ZKBR7A-HTU	
12 12 7 556 979	BKR7EQU	
12 12 7 570 106	ILZKBR7A-8G	
12 12 7 570 106.02	ILZKBR7A-8G	
12 12 7 600 994	SIZKBR8A8HS	
12 12 7 650 676	BKR7EKC	
12 12 7 650 676.3	BKR7EKC	
12 12 7 653 439	CR8EB	
12 12 7 653 771	BKR7EKC	
12 12 7 664 404	DR8EB	
12 12 7 671 301	DCPR8EKC	
12 12 7 671 302	BKR7EKC	
12 12 7 677 560	DCPR8EKC	
12 12 7 681 415	BKR7EKC	
12 12 7 698 956	MAR9A-J	
12 12 7 699 116	KR9CI	
12 12 7 710 636	CR9EKB	
12 12 7 719 772	LMAR9D-J	
12 12 7 726 112	MAR8B-JDS	
12 12 7 728 634	DCPR8EKC	
12 12 7 728 635	KR9CI	
12 12 7 728 657	LMAR8AI-8	
12 12 7 830 787	DCPR8EKP	
12 12 7 830 787.3	DCPR8EKP	
12 12 7 835 198	LKR8AP	
12 12 8 532 942	LMAR8D-J	
12 12 9 061 870	ZFR5F	
12 12 9 063 428	BKR6EK	20
12 12 9 064 617	BKR6EK	20
12 12 9 064 619	BKR6EK	20
12 12 9 064 656	BKR6EK	20
12 12 9 065 366	BKR6EK	20
12 12 9 069 048	PKR7A	
12 12 9 071 003	BKR6EQU	30
2 158 165	PLZKBR7A-G	
91 47 1 210 043	PFR7B	

<b>BOSCH</b>	<b>→ NGK</b>	<b>V-Line</b>
877 1207	R2349-10	
888 1101	R2349-11	
D 6 BC	AP6FS	
D 7 AC	A6FS	
D 7 BC	AP6FS	
D 8 BC	AP5FS	
D 9 BC	AP5FS	
D 10 BC	AP5FS	
DR 6 BC	APR6FS	
DR 7 BC	APR6FS	
DR 8 BC	APR5FS	
DR 9 BC	APR5FS	
DR 10 BC	APR5FS	
F 03 DAR	BKR6EK	20

<b>BOSCH</b>	<b>→ NGK</b>	<b>V-Line</b>
F 04 DAR	BKR6EK	20
F 2 CS	R7433-9	
F 2 DTC	R6888A-9	
F 3 CS	R7433-9	
F 4 CS	R7433-8	
F 5 DC	BCP7ES	
F 5 DPOR	PFR7B	
F 5 DTC	BCP7ET	
F 5 KPP 332SB	PFR7S8EG	
F 6 DC	BCP6ES	17
F 6 DC0	BCP6ES	17
F 6 DCOR	BKR6ES	28
F 6 DCX	BCP6ES-11	
F 6 DPOR	PFR6Q	37
F 6 DSR	BKR6EIX	
F 6 DTC	BCP6ET	
F 6 KPP 332S	PFR6Q	37
F 6 LTCR	BKUR7ET	
F 6 MPP 332	ILFR6A	
F 7 DC	BCP6ES	17
F 7 DC0	BCP6ES	17
F 7 DCOR	BKR6ES	28
F 7 DCX	BCP6ES-11	
F 7 DER	BKR6ES	28
F 7 DPER	PFR6G-11	
F 7 DPP 332	IFR6D10	
F 7 DTC	BCP6ET	
F 7 HER 2	ZFR5P-G	
F 7 HPP 22	PFR6Q	37
F 7 HPP 222	PZFR5D-11	34
F 7 HPP 222U	PZFR6J-11	
F 7 HPPRX	PZFR5D-11	34
F 7 KPP 332U	PFR6X-11	
F 7 KTCR	BKUR6ET-10	24
F 7 LCR2	ZFR6F-11	
F 7 LCR	ZFR6A-11	
F 7 LDCR	BKR6EK	20
F 7 LTCR	BKUR6ET-10	24
F 8 DC	BCP5ES	16
F 8 DC0	BCP5ES	16
F 8 DCOR	BKR5ES	35
F 8 DC4	BCP5ES	16
F 8 DCX	BCP5ES-11	
F 8 DPER	IFR5D10	
F 8 DPP 332	IFR5D10	
F 8 KTCR	BKUR5ET	29
F 8 LCR	ZFR5F	
F 8 LCR2	ZFR5F	
F 8 LDCR	BKR6EK	20
F 9 DC0	BCPR4ES-11	
F 9 LCR	ZFR4F-11	
FGR 5 KQE0	BKR7EQU	



<b>BOSCH</b>	<b>→ NGK</b>	<b>V-Line</b>
FGR 6 HQE0	ZFR6S-Q	
FGR 6 KQC	BKR6EQUP	30
FGR 6 KQE	BKR6EQUP	30
FGR 7 DPP10	BKR6EIX-11P	
FGR 7 DQE+	BKR6EKUB	
FGR 7 DQE0	BKR6EKUB	
FGR 7 DQP	BKR6EQUP	30
FGR 7 DQP+	BKR6EQUP	30
FGR 7 KQC	BKR6EQUP	30
FGR 7 KQE	BKR6EQUP	30
FGR 7 KQE0	BKR6EQUA	
FGR 8 KQE	BKR5EKUP	
FGR 8 KQE0	BKR5EQUPA	
FGR 8 MQPE	PLFR5A-11	
FLR 8 LDCU	BKR5EK	23
FLR 8 LDCU+	BKR5EK	23
FQR 8 DE	BKR6EZB	
FQR 8 LEU2	ZFR5F-11	
FR 5 DC	BCPR7ES	
FR 5 DCX	BCPR7ES-11	
FR 5 DTC	BCPR7ET	
FR 5 KPP 332S	PFR7S8EG	
FR 5 LDC	BKR7EKC	
FR 6 D 133	IFR6J11	
FR 6 DC	BKR6ES	28
FR 6 DC+	BKR6ES	28
FR 6 DC0	BKR6EK	20
FR 6 DC2	BKR6ES	28
FR 6 DCX	BKR6ES-11	14
FR 6 DDC	BKR7EKC	
FR 6 DTC	BCPR6ET	
FR 6 DTCW	BKR5EKC	
FR 6 HI 332	PZFR6R	
FR 6 KDC	BKR6EZ	38
FR 6 KDC+	BKR6EZ	38
FR 6 KDE0	BKR6EKE	
FR 6 KTC	BKUR6ET	27
FR 6 LDC	BKR6EK	20
FR 6 MPP 10	PLFR6A-11	
FR 6 MPP 332	ILFR6A	
FR 7 DC	BKR6ES	28
FR 7 DC+	BKR6ES	28
FR 7 DC0	BKR6ES	28
FR 7 DC2	BKR6ES	28
FR 7 DC4	BKR6ES	28
FR 7 DCX	BKR6ES-11	14
FR 7 DCX+	BKR6ES-11	14
FR 7 DE	BKR6EZ	38
FR 7 DPP+	PFR6B	
FR 7 DPP 10	BKR6EIX	
FR 7 DPP 22U	PFR6N-11	
FR 7 DPP 33	PFR6Q	37

<b>BOSCH</b>	<b>→ NGK</b>	<b>V-Line</b>
FR 7 DQP	BKR6EQUP	30
FR 7 DTC	BCPR6ET	
FR 7 HCOX	ZFR5E-11	
FR 7 HE2	ZFR5P-G	
FR 7 HPP 33+	PZFR5D-11	34
FR 7 KC	BKR6EY	
FR 7 KC+	BKR6EY	
FR 7 KCU	BKR6EYA-11	
FR 7 KCW	BKR6EP-13	
FR 7 KCX	BKR6EY-11	
FR 7 KCX+	BKR6EY-11	
FR 7 KDC	BKR6EZ	38
FR 7 KI30	FR6EI	
FR 7 KPP 33+	PFR6Q	37
FR 7 KPP 332	IZFR6H11	
FR 7 LC2	BKR6ES	28
FR 7 LCX	ZFR6F-11	
FR 7 LCX+	ZFR6F-11	
FR 7 LDC	BKR6EK	20
FR 7 LDC+	BKR6EK	20
FR 7 LDU	BKR6EK	20
FR 7 ME	LFR6A	
FR 7 MPP 10	PLFR6A	
FR 7 NI 33	ILFR6B	
FR 7 NI 332S	ILFR6K8	
FR 7 NPP 332	ILZFR6D11	
FR 7 SI 30	ILZFR6C-11K	
FR 8 DC	BKR5ES	35
FR 8 DC+	BKR5ES	35
FR 8 DC0	BKR5ES	35
FR 8 DCX	BKR5ES-11	33
FR 8 DCX+	BKR5ES-11	33
FR 8 DE	BKR5ES	35
FR 8 DPP 33	PFR5R-11	
FR 8 DPP 33+	PFR5R-11	
FR 8 DS	BKR5EIX	
FR 8 DX	BKR5ES-11	33
FR 8 HDC	BKR5EKB-11	
FR 8 HDC+	BKR5EKB-11	
FR 8 KCU	BKR5EYA-11	39
FR 8 KDC	BKR5EK	23
FR 8 LCX	ZFR6F-11	
FR 8 LDC	BKR5EK	23
FR 8 LDC4	BKR5EK	23
FR 8 LTC	BKUR5ET-10	
FR 8 ME	LFR5B	
FR 8 SPP 332	ILFR5B11	
FR 9 DC	BKR5ES	35
FR 9 DCX	BCPR4ES-11	
FR 9 HC	ZFR4F-11	
FR 10 DCX	BCPR4ES-11	
H 2 CS	B9EFS	



<b>BOSCH</b>	<b>→ NGK</b>	<b>V-Line</b>
H 3 CS	B8EFS	
H 5 DC	BP7EFS	
H 5 DC0	BP7EFS	
H 6 BC	BP6FS	
H 6 DC	BP6EFS	5
H 6 DC0	BP6EFS	5
H 7 CC	BR6EF	
H 7 DC	BP6EFS	5
H 7 DC0	BP6EFS	5
H 7 DCY	BP6EFS-13	
H 8 BC	BP5FS	
H 8 DC	BP5EFS	
H 8 DC0	BP5EFS	
H 8 DCX	BP5EFS-13	
H 9 BC	BP4FS	
H 9 BCY	BPR4FS-15	
H 9 DC	BP5EFS	
H 9 DC0	BP5EFS	
H 10 BC	BP4FS	
H 10 C	BP4FS	
HGR 6 KQC	BUR6EFSZ	
HGR 7 KQC	BUR6EFSZ	
HLR 8 STEX	LTR6B-10T	
HR 6 BC	BPR6FS	
HR 6 DC	BPR6EFS	7
HR 6 DC+	BPR6EFS	7
HR 6 DS	BPR6EFS	7
HR 7 DC	BPR6EFS	7
HR 7 DC+	BPR6EFS	7
HR 7 DCX	BPR6EFS-13	
HR 7 DCX+	BPR6EFS-13	
HR 7 DCY	BPR6EFS-15	
HR 7 DCY+	BPR6EFS-15	
HR 7 MPP+	PTR5A-13	25
HR 7 MPP 302	PTR5A-13	25
HR 8 AC	BR5FS	
HR 8 ACY	BR5FS	
HR 8 BC	BPR5FS	
HR 8 BCY	BPR5FS-15	
HR 8 DC+	BPR5EFS	
HR 8 DPP 22U	PTR5D-10	31
HR 8 LCO	TR5-1	
HR 8 MCV+	TR5B-13	
HR 8 MEV	TR5B-13	
HR 9 AC	BR5FS	
HR 9 ACY	BR5FS	
HR 9 BC	BPR4FS	
HR 9 BC+	BPR4FS	
HR 9 BCY	BPR4FS-15	
HR 9 BCY+	BPR4FS-15	
HR 9 DC	BPR5EFS	
HR 9 DCX	BPR5EFS-13	

<b>BOSCH</b>	<b>→ NGK</b>	<b>V-Line</b>
HR 9 DCY+	TR55	
HR 10 AC	BR5FS	
HR 10 ACY	BR5FS	
HR 10 BC	BPR4FS	
HR 10 BCX	BPR4FS-11	
HR 10 BCY	BPR4FS-15	
HS 5 E	BM7F	
HS 8 E	BM6F	
M 4 AC	AB-7	
M 5 AC	AB-7	
M 7 AC	AB-7	
M 8 AC	AB-6	
M 8 AC0	AB-6	
M 10 AC	AB-6	
M 10 AC0	AB-6	
M 12 B	AP5FS	
U 3 CC	C7E	
U 4 AC	C6HSA	
U 5 AC	C5HSA	
U 6 AC	CR4HSA	
UR 2 AS	CR8HS	
UR 2 CC	CR8E	
UR 3 AC	CR7HSA	
UR 3 AS	CR7HS	
UR 3 CC	CR7E	
UR 4 AS	CR6HS	
UR 6 AC	CR6HS	
USR 7 AC	CMR6H	
VR 8 SE	LZKAR7A	
VR 8 SEW	LZKAR7A	
W 2 AC	B9HS	
W 2 AS	BR9HIX	
W 2 C0	B10ES	
W 2 CC	B10ES	
W 2 CS	BR10EIX	
W 3 A0	B8HS	
W 3 AC	B8HS	
W 3 AS	BR8HIX	
W 3 C0	B9ES	
W 3 CC	B9ES	
W 3 CS	BR9EIX	
W 3 DP	BPR8EIX	
W 3 DP0	BPR8EIX	
W 3 DP2	BP8ES	
W 4 AC	B8HS	
W 4 AS	BR8HIX	
W 4 CC	B8ES	
W 4 CPX	B8ES	
W 4 CS	BR8EIX	
W 4 DP	BPR7EIX	
W 4 DP0	BPR8EIX	
W 4 E2	B7S	



BOSCH	→ NGK	V-Line
W 5 AC	B7HS	
W 5 AS	BR7HIX	
W 5 BC	BP7HS	
W 5 BC	BP7HS-10	
W 5 CC	B7ES	
W 5 CCX	B7ES-11	
W 5 CS	BR7EIX	
W 5 DC	BP7ES	
W 5 DC0	BP7ES	
W 5 DCX	BP7ES-11	
W 5 DTC	BUR6ET	1
W 5 EC	B7S	
W 6 AC	B6HS	
W 6 BC	BP6HS	18
W 6 DC	BP6ES	4
W 6 DC0	BP6ESZ	
W 6 DCX	BP6ES-11	
W 6 DTC	BUR6ET	1
W 6 LTCR	BUR6ET	1
W 7 AC	B6HS	
W 7 AC	B6HS-5	
W 7 A00	B6HS	
W 7 BC	BP6HS	18
W 7 BC	BP6HS-10	
W 7 CC	B6ES	
W 7 CC0	B6ES	
W 7 CCX	B6ES-11	
W 7 DC	BP6ES	4
W 7 DC0	BP6ESZ	
W 7 DCR	BPR6ES	2
W 7 DCX	BP6ES-11	
W 7 DTC	BUR6ET	1
W 7 DX	BP6ES-11	
W 7 EC	B6S	
W 7 FC	BP6S	
W 7 LTCR	BUR6ET	1
W 8 AC	B5HS	
W 8 BC	BP5HS	
W 8 CC	B5ES	
W 8 CCX	B5ES	
W 8 DC	BP5ES	8
W 8 DC0	BP5ES	8
W 8 DCX	BP5ES-11	
W 8 DCY	BP5ES-13	
W 8 DTC	BP5ET	
W 8 DTC	BP5ET-10	
W 8 EC	B6S	
W 8 FC	BP5S	
W 8 LCR	ZGR5A	15
W 8 LDCR	BUR6ET	1
W 8 LTCR	BUR5ET	22
W 8 LTCR	BUR5ET-10	21

BOSCH	→ NGK	V-Line
W 9 AC	B5HS	
W 9 AC0	B5HS	
W 9 CC	B4ES	
W 9 DC	BP5ES	8
W 9 DC0	BP5ES	8
W 9 DCX	BP5ES-11	
W 9 DTC	BP5ET	
W 9 EC	B-4	
W 9 EC0	B4-LM	
W 9 FC	BP5S	
W 9 LC	ZGR5A	15
W 06 CS	B11EGV	
W 07 AS	BR10HIX	
W 07 CS	B10EGV	
W 08 AS	BR9HIX	
W 08 CS	B10EGV	
W 10 AC	B-4H	
W 10 CC	B4ES	
W 10 DC	BP4ES	
W 10 EC	B-4	
W 10 FC	BP-4	
W 12 A	B-4H	
W 12 E	B-2	
WEA	BUH	
WEC	BUE	
WET 1	BUH	
WET 2	BUE	
WR 2 CC	BR10ES	
WR 3 CC	BR9ES	
WR 3 CS	BR9EIX	
WR 3 CTC	BR9ET	
WR 4 AC	BR8HS	
WR 4 CC	BR8ES	
WR 5 AC	BR7HS	
WR 5 CC	BR7ES	
WR 5 DC	BPR7ES	19
WR 5 DC+	BPR7ES	19
WR 5 DS	BPR7EIX	
WR 6 BC	BPR6HS	3
WR 6 DC	BPR6ES	2
WR 6 DC+	BPR6ES	2
WR 6 DCX	BPR6ES-11	13
WR 6 DS	BPR6EIX	
WR 6 DTC	BUR6ET	1
WR 7 AC	BR6HS	
WR 7 BC	BPR6HS	3
WR 7 BC+	BPR6HS	3
WR 7 CC	BR6ES	
WR 7 CCX	BR6ES-11	
WR 7 DC	BPR6ES	2
WR 7 DC+	BPR6ES	2
WR 7 DC2	BPR6ES	2



<b>BOSCH</b>	<b>→ NGK</b>	<b>V-Line</b>
WR 7 DCX	BPR6ES-11	13
WR 7 DCX+	BPR6ES-11	13
WR 7 DS	BPR6EIX	
WR 7 DTC	BUR6ET	1
WR 7 EC	BR6S	
WR 7 F	BP6S	
WR 7 LTC+	BUR6ET	1
WR 8 AC	BR5HS	
WR 8 BC	BPR5HS	
WR 8 BC+	BPR5HS	
WR 8 CC	BR5ES	
WR 8 DC	BPR5ES	6
WR 8 DC+	BPR5ES	6
WR 8 DC0	BPR5ES	6
WR 8 DC4	BPR5ES	6
WR 8 DCX	BPR5ES-11	
WR 8 DCX+	BPR5ES-11	
WR 8 DS	BPR5EIX	
WR 8 EC	BR6S	
WR 8 FC	BP5S	
WR 8 HP	ZGR5C	
WR 8 LC+	ZGR5A	15
WR 8 LTC+	BUR5ET-10	21
WR 9 A0	BR5HS	
WR 9 CC	BR5ES	
WR 9 DC	BPR5ES	6
WR 9 DC+	BPR5ES	6
WR 9 DCX	BPR5ES-11	
WR 9 DCX+	BPR5ES-11	
WR 9 DCY	BPR5ES-13	
WR 9 DS	BPR5EIX	
WR 9 EC	BR6S	
WR 9 EC0	BR6S	
WR 9 FC	BP5S	
WR 9 FCY	BP5S	
WR 9 HC	ZGR5C	
WR 9 LC	ZGR5A	15
WR 9 LS	ZGR5A	15
WR 10 AC	BR4HS	
WR 10 E	BR6S	
WR 10 FC	BP-4	
WR 10 FCY	BP-4	
WR 10 LC	ZGR5B	
WR 10 LCV	BPR4ES-13	
WR 11 E0	BR4-LM	
WS 5 E	BM7A	
WS 5 F	BPM7A	
WS 6 E	BM6A	
WS 6 F	BPM6A	
WS 7 E	BM6A	
WS 7 F	BPM6A	
WS 8 E	BM6A	

<b>BOSCH</b>	<b>→ NGK</b>	<b>V-Line</b>
WS 8 F	BPM6A	
WS 9 EC	BM4A	
WSR 5 F	BPMR7A	
WSR 6 E	BMR6A	
WSR 6 F	BPMR7A	
WSR 7 F	BPMR6A	
WSR 9 EC	BMR4A	
X 3 CP0	D9EA	
X 4 CS	D8EA	
X 5 CC	D8EA	
X 5 DC	DP7EA-9	
XR 2 AS	DR8HS	
XR 2 CS	DR8ES	
XR 4 AS	DR8HS	
XR 4 CS	DR8ES	
XR 4 DC	DPR8EA-9	
XR 5 DC	DPR7EA-9	
XR 6 CC	DR7EA	
XR 7 LDC	DPR7EA-9	
Y 6 DC	DCP6E	
YR 5 DDE	KR9CI	
YR 5 LDE	DCPR8EKC	
YR 6 LDE	DCPR8EKC	
YR 6 NPP 332	PLKR7B8E	
YR 7 DC+	ZKR7A-10	
YR 7 DE	DCPR8E-N	
YR 7 MPP 33	PLKR7A	
ZQR 8 SI 302	PLZKBR7A-G	
ZR 7 SI 332 S	PLZKBR7A-G	
+1	BPR6ES	2
+2	BUR6ET	1
+3	BPR5ES	6
+4	BUR5ET-10	21
+5	BPR6EFS	7
+6	BKR5ES	35
+7	BKR6EK	20
+8	BKR6ES	28
+9	BKR5EK	23
+10	BPR6HS	3
+11	BKR6ES-11	14
+12	BPR6ES	2
+13	BKR6ES	28
+14	BPR5EFS	
+15	BPR7ES	19
+16	BPR5ES	6
+17	PTR5A-13	25
+18	BPR6EFS	7
+19	BKR5ES-11	33
+20	BPR5HS	
+21	BPR6ES-11	13
+22	BPR5ES-11	
+23	BKR6EKUB	





BOSCH	→ NGK	V-Line
+24	PFR6B	
+25	BPR4FS	
+26	TR55	
+27	BPR5ES-11	
+31	BKR6EY-11	
+32	ZFR6F-11	
+33	BPR4FS-15	
+34	ZGR5A	15
+36	BKR5EKB-11	
+37	BPR6EFS-15	
+39	TR5B-13	
+45	PFR5R-11	
+46	BPR6EFS-13	
+47	BKR6EY	
+48	BKR6EQUP	30
+50	PFR6Q	37
+52	PZFR5D-11	34
+53	BKR6EZ	38
0 241 040 501	CR4HSA	
0 241 045 001	C5HSA	
0 241 050 002	C6HSA	
0 241 056 501	C7E	
0 241 140 500	DCP6E	
0 241 145 003	DP7EA-9	
0 241 145 504	DP7EA-9	
0 241 145 507	D8EA	
0 241 150 502	D8EA	
0 241 200 500	BUH	
0 241 209 003	B-4H	
0 241 219 536	BP-4	
0 241 219 537	BP4FS	
0 241 219 540	B-4H	
0 241 219 541	B4ES	
0 241 219 542	BP4ES	
0 241 219 543	B-4H	
0 241 219 554	B-4	
0 241 225 013	BP5ES	8
0 241 225 543	BP4FS	
0 241 225 545	BP5ES	8
0 241 225 547	B4ES	
0 241 225 548	B-4	
0 241 225 549	B5HS	
0 241 225 550	BP5ES	8
0 241 225 555	BPR4FS-15	
0 241 225 556	BP5ES	8
0 241 225 558	BP5EFS	
0 241 225 573	BP5EFS	
0 241 225 574	BCPR4ES-11	
0 241 225 576	BP5ET	
0 241 225 582	BP5ES-11	
0 241 225 585	ZGR5A	15
0 241 225 589	BM4A	

BOSCH	→ NGK	V-Line
0 241 225 590	B4-LM	
0 241 229 059	ZGR5A	15
0 241 229 060	BP5ET-10	
0 241 229 061	BP5ES	8
0 241 229 062	BP5ES	8
0 241 229 541	BM6F	
0 241 229 560	BM6A	
0 241 229 561	BPM6A	
0 241 229 574	BP5ES	8
0 241 229 578	BP5HS	
0 241 229 579	B5ES	
0 241 229 580	B6S	
0 241 229 588	BP5ES	8
0 241 229 593	BP5S	
0 241 229 594	BP5FS	
0 241 229 596	BP5ES-11	
0 241 229 604	B5HS	
0 241 229 612	B5HS	
0 241 229 617	BP5EFS	
0 241 229 619	BP5ET	
0 241 229 634	BCP5ES	16
0 241 229 639	ZFR5F	
0 241 229 641	BP5HS	
0 241 229 649	BP5EFS	
0 241 229 657	ZFR5F	
0 241 229 661	BUR6ET	1
0 241 229 663	BUR5ET-10	21
0 241 229 665	BUR5ET	22
0 241 229 666	BKR6EK	20
0 241 229 676	BKUR5ET	29
0 241 229 682	BCP5ES-11	
0 241 229 684	BKR5ES	35
0 241 229 704	IFR5D10	
0 241 229 713	BCP5ES	16
0 241 229 926	BP5ES	8
0 241 235 089	B6ES	
0 241 235 098	B6ES	
0 241 235 099	BPR6ES	2
0 241 235 103	BP6ESZ	
0 241 235 108	BCP6ET	
0 241 235 563	BP6ES	4
0 241 235 564	BP6HS	18
0 241 235 566	BM6A	
0 241 235 567	BPM6A	
0 241 235 574	B6ES	
0 241 235 585	BP6HS-10	
0 241 235 594	B6S	
0 241 235 602	BP6ES	4
0 241 235 607	B6HS	
0 241 235 610	BP6ES-11	
0 241 235 619	B6HS-5	
0 241 235 623	BP6S	



<b>BOSCH</b>	<b>→ NGK</b>	<b>V-Line</b>
0 241 235 633	BUR6ET	1
0 241 235 635	BP6EFS	5
0 241 235 636	BP6EFS	5
0 241 235 638	BR6EF	
0 241 235 643	BUR6ET	1
0 241 235 646	BP6EFS-13	
0 241 235 668	BP6EFS	5
0 241 235 673	BCP6ES	17
0 241 235 674	ZFR6A-11	
0 241 235 676	BCP6ES	17
0 241 235 681	BP6EFS	5
0 241 235 685	BCP6ES-11	
0 241 235 690	BKR6EK	20
0 241 235 692	ZFR6F-11	
0 241 235 693	BP6ESZ	
0 241 235 698	BUR6ET	1
0 241 235 705	BP6ESZ	
0 241 235 706	BKUR6ET-10	24
0 241 235 715	PZFR5D-11	34
0 241 235 735	ZFR5P-G	
0 241 235 736	BKR6ES	28
0 241 235 739	IFR6D10	
0 241 240 057	BP6ESZ	
0 241 240 058	BP6ESZ	
0 241 240 524	BP6EFS	5
0 241 240 530	BP6ES	4
0 241 240 532	BP6HS	18
0 241 240 539	BP6ES	4
0 241 240 542	BCP6ES	17
0 241 240 543	BP6FS	
0 241 240 558	BUR6ET	1
0 241 240 563	BP6EFS	5
0 241 240 564	BCP6ET	
0 241 240 569	BCP6ES-11	
0 241 240 574	BP6ES-11	
0 241 240 578	BP6EFS	5
0 241 240 585	BKR6EIX	
0 241 240 587	BKR6ES	28
0 241 240 592	BKUR7ET	
0 241 240 600	BM6A	
0 241 240 601	BPM6A	
0 241 240 603	B6HS	
0 241 240 631	ILFR6A	
0 241 245 070	BUR6ET	1
0 241 245 539	BM7F	
0 241 245 552	BP7ES	
0 241 245 553	BP7HS	
0 241 245 554	BM7A	
0 241 245 555	BPM7A	
0 241 245 570	BP7EFS	
0 241 245 574	BR7HIX	
0 241 245 575	BR7EIX	

<b>BOSCH</b>	<b>→ NGK</b>	<b>V-Line</b>
0 241 245 580	B7HS	
0 241 245 581	B7ES	
0 241 245 592	B7S	
0 241 245 599	BP7ES	
0 241 245 602	B7HS	
0 241 245 603	B7ES	
0 241 245 619	BP7HS	
0 241 245 636	BP7EFS	
0 241 245 641	PFR7B	
0 241 245 642	BCP7ES	
0 241 245 646	BP7HS-10	
0 241 248 531	B8HS	
0 241 248 538	B8ES	
0 241 248 540	B8HS	
0 241 250 502	BPR8EIX	
0 241 250 512	BPR8EIX	
0 241 250 526	R7433-8	
0 241 252 521	BR8HIX	
0 241 255 505	B8EFS	
0 241 255 507	R7433-9	
0 241 256 512	B8HS	
0 241 256 514	BR8HIX	
0 241 256 515	BR9EIX	
0 241 256 517	BPR8EIX	
0 241 256 519	B8HS	
0 241 256 522	B9ES	
0 241 260 507	B9HS	
0 241 260 508	B10ES	
0 241 260 510	B9EFS	
0 241 260 512	R7433-9	
0 241 262 505	BR9HIX	
0 241 262 506	BR10EIX	
0 241 268 505	BR9HIX	
0 241 268 506	B10EGV	
0 241 274 504	BR10HIX	
0 241 274 505	B10EGV	
0 241 280 503	B11EGV	
0 241 309 501	AP5FS	
0 241 319 510	AP5FS	
0 241 319 512	AB-6	
0 241 319 513	AB-6	
0 241 325 509	AP5FS	
0 241 329 520	AP5FS	
0 241 329 525	AB-6	
0 241 329 526	AB-6	
0 241 335 516	AP6FS	
0 241 335 520	A6FS	
0 241 335 524	AB-7	
0 241 335 526	AB-7	
0 241 340 501	AP6FS	
0 241 345 512	AB-7	
0 241 350 505	AB-7	



BOSCH	→ NGK	V-Line
0 242 035 500	CMR6H	
0 242 040 500	CR6HS	
0 242 050 500	CR6HS	
0 242 055 500	CR7HS	
0 242 055 501	CR7HSA	
0 242 055 502	CR7E	
0 242 060 500	CR8HS	
0 242 060 501	CR8E	
0 242 129 503	LZKAR7A	
0 242 129 508	LZKAR7A	
0 242 129 512	PLZKBR7A-G	
0 242 135 500	DPR7EA-9	
0 242 135 501	DCPR8E-N	
0 242 135 509	PLKR7A	
0 242 135 515	ZKR7A-10	
0 242 135 518	PLZKBR7A-G	
0 242 140 500	DR7EA	
0 242 140 504	DCPR8EKC	
0 242 140 512	PLKR7B8E	
0 242 145 500	DPR7EA-9	
0 242 145 501	DPR7EA-9	
0 242 145 503	DCPR8EKC	
0 242 145 504	KR9CI	
0 242 150 500	DR8HS	
0 242 150 501	DR8ES	
0 242 150 505	DPR8EA-9	
0 242 160 501	DR8ES	
0 242 215 502	BR4-LM	
0 242 219 004	BR4HS	
0 242 219 511	BPR4FS-15	
0 242 219 512	BP-4	
0 242 219 513	BP-4	
0 242 219 514	BR5FS	
0 242 219 515	BR5FS	
0 242 219 516	BPR4FS	
0 242 219 517	BPR4FS-11	
0 242 219 519	BCPR4ES-11	
0 242 219 520	BP-4	
0 242 219 529	ZGR5B	
0 242 219 530	BPR4ES-13	
0 242 225 522	BR6S	
0 242 225 523	BR5ES	
0 242 225 524	BPR5ES	6
0 242 225 525	BPR5ES-13	
0 242 225 526	BP5S	
0 242 225 527	BP5S	
0 242 225 528	ZGR5C	
0 242 225 529	BR5FS	
0 242 225 530	BR5FS	
0 242 225 531	BPR4FS	
0 242 225 532	BPR4FS-15	
0 242 225 533	BPR5EFS	

BOSCH	→ NGK	V-Line
0 242 225 534	BPR5EFS-13	
0 242 225 536	BR6S	
0 242 225 537	ZFR4F-11	
0 242 225 538	BPR5EIX	
0 242 225 539	ZGR5A	15
0 242 225 548	BPR5ES-11	
0 242 225 549	BCPR4ES-11	
0 242 225 550	BPR5ES	6
0 242 225 582	BKR5ES	35
0 242 225 599	BPR5ES	6
0 242 225 612	BMR4A	
0 242 225 622	BPR4FS	
0 242 225 623	TR55	
0 242 225 624	BPR5ES-11	
0 242 225 641	BPR4FS-15	
0 242 225 859	BPR5ES	6
0 242 225 861	BPR5ES	6
0 242 229 524	BR6S	
0 242 229 525	BP5S	
0 242 229 526	BR5FS	
0 242 229 528	BPR5FS	
0 242 229 529	BPR5FS-15	
0 242 229 530	BKR5ES-11	33
0 242 229 531	BPR5ES	6
0 242 229 533	BR5ES	
0 242 229 534	BR5HS	
0 242 229 537	BPR5EIX	
0 242 229 538	BPR5ES	6
0 242 229 566	BPR5ES-11	
0 242 229 568	BKR5ES	35
0 242 229 570	BPR5ES	6
0 242 229 576	ZFR6F-11	
0 242 229 587	BKR5ES	35
0 242 229 589	BPR5HS	
0 242 229 591	BKR5EK	23
0 242 229 594	BKR5ES	35
0 242 229 598	BKR5EIX	
0 242 229 605	BKR5EK	23
0 242 229 607	BPR5ES	6
0 242 229 610	BPR5HS	
0 242 229 613	BKR5EKUP	
0 242 229 625	BKUR5ET-10	
0 242 229 626	BKR5EK	23
0 242 229 628	BKR5EK	23
0 242 229 630	LF5B	
0 242 229 634	PLFR5A-11	
0 242 229 635	BKR5EYA-11	39
0 242 229 641	PTR5D-10	31
0 242 229 648	BKR5EQUA	
0 242 229 650	TR5B-13	
0 242 229 654	BKR5EK	23
0 242 229 655	BPR5EFS	



<b>BOSCH</b>	<b>→ NGK</b>	<b>V-Line</b>
0 242 229 656	BPR5ES	6
0 242 229 657	BPR5HS	
0 242 229 658	BUR5ET-10	21
0 242 229 659	BKR5ES	35
0 242 229 660	BKR5ES-11	33
0 242 229 661	LTR6B-10T	
0 242 229 671	BKR5EKB-11	
0 242 229 673	BKR5ES	35
0 242 229 687	BPR5ES-11	
0 242 229 699	ZFR5F-11	
0 242 229 708	ILFR5B11	
0 242 229 713	PFR5R-11	
0 242 229 724	BKR6EZB	
0 242 229 779	ZGR5A	15
0 242 229 781	BKR5EKB-11	
0 242 229 785	TR5B-13	
0 242 229 878	BKR5EK	23
0 242 229 879	BPR5EFS	
0 242 229 880	BPR5ES	6
0 242 229 881	BPR5HS	
0 242 229 882	BUR5ET-10	21
0 242 229 883	BKR5ES	35
0 242 229 884	BKR5ES-11	33
0 242 229 885	BPR5ES-11	
0 242 229 887	BKR5EK	23
0 242 229 925	PFR5R-11	
0 242 229 982	BPR5ES	6
0 242 230 500	PFR5R-11	
0 242 235 511	BPR6ES	2
0 242 235 522	BPR6HS	3
0 242 235 525	BPR6EIX	
0 242 235 529	BPR6ES	2
0 242 235 530	BPR6ES-11	13
0 242 235 532	BR6ES	
0 242 235 533	BR6HS	
0 242 235 537	BPR6ES	2
0 242 235 538	BPR6EFS	7
0 242 235 542	BPR6EFS	7
0 242 235 543	BR6ES-11	
0 242 235 544	BKR6ES-11	14
0 242 235 551	BKR6ES	28
0 242 235 554	BR6S	
0 242 235 564	BCPR6ET	
0 242 235 567	ZFR6F-11	
0 242 235 571	BUR6ET	1
0 242 235 577	BPR6EFS-15	
0 242 235 579	BKR6ES	28
0 242 235 587	BKR6ES	28
0 242 235 588	BKR6ES	28
0 242 235 589	BKR6EK	20
0 242 235 590	BUR6ET	1
0 242 235 592	BPR6EFS-13	

<b>BOSCH</b>	<b>→ NGK</b>	<b>V-Line</b>
0 242 235 597	BKR6ES	28
0 242 235 599	BKR6EY	
0 242 235 602	BKR6EY-11	
0 242 235 605	BKR6EK	20
0 242 235 607	BUR6EFSZ	
0 242 235 609	BKR6EZ	38
0 242 235 610	BKR6EP-13	
0 242 235 616	BKR6ES	28
0 242 235 617	BKR6EQUF	30
0 242 235 624	BKR6ES	28
0 242 235 630	BPR6ES	2
0 242 235 636	LFR6A	
0 242 235 640	BKR6EZ	38
0 242 235 642	BKR6EKUB	
0 242 235 651	BPMR6A	
0 242 235 656	BKR6EQUF	30
0 242 235 659	BKR6EYA-11	
0 242 235 661	BPR6EFS	7
0 242 235 663	BPR6ES	2
0 242 235 664	BUR6ET	1
0 242 235 665	BPR6HS	3
0 242 235 666	BKR6ES	28
0 242 235 667	BKR6ES-11	14
0 242 235 668	BKR6EK	20
0 242 235 690	PFR6N-11	
0 242 235 692	ZFR5E-11	
0 242 235 699	BKR6EIX	
0 242 235 707	BPR6ES-11	13
0 242 235 715	BKR6EQUA	
0 242 235 740	PFR6Q	37
0 242 235 743	PLFR6A	
0 242 235 748	BKR6EKUB	
0 242 235 749	PFR6B	
0 242 235 761	ZFR5P-G	
0 242 235 767	PTR5A-13	25
0 242 235 769	ILZFR6C-11K	
0 242 235 776	IZFR6H11	
0 242 235 908	BPR6EFS	7
0 242 235 909	BPR6ES	2
0 242 235 910	BUR6ET	1
0 242 235 911	BPR6HS	3
0 242 235 912	BKR6ES	28
0 242 235 913	BKR6ES-11	14
0 242 235 914	BKR6EK	20
0 242 235 915	BPR6ES-11	13
0 242 235 916	PTR5A-13	25
0 242 235 917	BKR6EKUB	
0 242 235 918	PFR6B	
0 242 235 930	BPR6ES	2
0 242 235 931	BUR6ET	1
0 242 235 979	BPR6EFS-13	
0 242 235 980	BKR6EY	



BOSCH	→ NGK	V-Line
0 242 235 981	BKR6EQUP	30
0 242 235 982	PFR6Q	37
0 242 235 984	PZFR5D-11	34
0 242 235 985	BKR6EY-11	
0 242 235 986	ZFR6F-11	
0 242 236 510	ILZFR6D11	
0 242 236 528	ILFR6B	
0 242 236 541	BKR6EY-11	
0 242 236 542	ZFR6F-11	
0 242 236 543	BPR6EFS-15	
0 242 236 560	BPR6EFS-13	
0 242 236 561	BKR6EY	
0 242 236 562	BKR6EQUP	30
0 242 236 564	PFR6Q	37
0 242 236 566	PZFR5D-11	34
0 242 236 577	ILFR6K8	
0 242 240 511	BPR6ES	2
0 242 240 514	BPR6EFS	7
0 242 240 516	BPR6EIX	
0 242 240 519	BPR6EFS	7
0 242 240 520	BPR6FS	
0 242 240 526	BKR6ES	28
0 242 240 528	BCPR6ET	
0 242 240 531	BPR6ES-11	13
0 242 240 539	BKR6ES-11	14
0 242 240 546	BUR6ET	1
0 242 240 547	BKR5EKC	
0 242 240 557	BKR6EK	20
0 242 240 561	BPR6HS	3
0 242 240 562	BKR6EZ	38
0 242 240 565	BKR7EKC	
0 242 240 566	BKR6EK	20
0 242 240 569	BUR6EFSZ	
0 242 240 572	BKUR6ET	27
0 242 240 576	BPMR7A	
0 242 240 579	BPR6ES	2
0 242 240 582	BMR6A	
0 242 240 584	BKR6EKE	
0 242 240 587	BKR6EQUP	30
0 242 240 590	ZFR6S-Q	
0 242 240 591	BPR6EFS	7
0 242 240 592	BPR6ES	2
0 242 240 593	BKR6ES	28
0 242 240 619	ILFR6A	
0 242 240 648	BKR6EZ	38
0 242 240 665	PZFR6R	
0 242 240 848	BPR6EFS	7
0 242 240 849	BPR6ES	2
0 242 240 850	BKR6ES	28
0 242 240 851	BKR6ES	28
0 242 245 018	BKR7EKC	
0 242 245 514	BPR7EIX	

BOSCH	→ NGK	V-Line
0 242 245 515	BCPR7ES	
0 242 245 517	BR7HS	
0 242 245 521	BR7ES	
0 242 245 533	BPMR7A	
0 242 245 536	BCPR7ES	
0 242 245 537	BPR7ES	19
0 242 245 539	BCPR7ET	
0 242 245 550	BCPR7ES-11	
0 242 245 552	BPR7ES	19
0 242 245 559	BKR7EQUP	
0 242 245 576	PFR7S8EG	
0 242 245 812	BPR7ES	19
0 242 250 503	BR8ES	
0 242 250 506	BR8HS	
0 242 255 501	BR9ET	
0 242 255 502	BR9ES	
0 242 255 504	BR9EIX	
0 242 260 001	BR10ES	
0 242 319 501	APR5FS	
0 242 325 501	APR5FS	
0 242 329 503	APR5FS	
0 242 335 504	APR6FS	
0 242 340 501	APR6FS	
F 000 KE0 017	BKUR6ET-10	24
F 000 KE0 P34	BPR6ES	2
F 5KP P33 2GF	PFR8S8EG	

BRISK	→ NGK	V-Line
B 12 YC	DP9EA-9	
B 14 YC	DP8EA-9	
B 15 YC	DP7EA-9	
D 12 YC	BCP7ES	
D 14 Y	BCP7ES	
D 14 YC	BCP7ES	
D 15 Y	BCP6ES	17
D 15 YC	BCP6ES	17
D 17 Y	BCP5ES	16
D 17 YC	BCP5ES	16
DOX 15 LE 1	ZFR6T-11G	
DR 12 YC	BKR7E	
DR 14 YC	BKR7E	
DR 14 ZC	ZFR7F-11	
DR 14 ZC 1	BCPR7ES-11	
DR 15 TC	BKUR5ET-10	
DR 15 YC	BKR6ES	28
DR 15 Z	BKR6ES	28
DR 15 Z 1	BKR6ES-11	14
DR 17 YC	BKR5ES	35
F 14 YC	AP7FS	
F 15 YC	AP6FS	
FR 14 YC	APR6FS	
FR 15 YC	APR6FS	





BRISK	→ NGK	V-Line
G 12 YC	BP7EFS	
G 14 Y	BP7EFS	
G 14 YC	BP7EFS	
G 15 Y	BP6EFS	5
G 15 YC	BP6EFS	5
G 17 Y	BP5EFS	
G 17 YC	BP5EFS	
GR 15 YC	BPR6EFS	7
GR 17 YC	BPR5EFS	
J 17	B4-LM	
J 19	B2-LM	
JR 17	BR4-LM	
JR 19	BR2-LM	
K 15 YC	BP6S	
K 17 C	B6S	
K 17 Y	BP5S	
K 19	B-4	
L 08 JW	B10EGV	
L 08 W	B11EGV	
L 10 JW	B8EGV	
L 12 W	BR9EIX	
L 12 Y	BP8ES	
L 12 YC	BP8ES	
L 14	B8ES	
L 14 C	B8ES	
L 14 Y	BP7ES	
L 14 YC	BP7ES	
L 15	B7ES	
L 15 C	B7ES	
L 15 W	BR7EIX	
L 15 Y	BP6ES	4
L 15 YC	BP6ES	4
L 17	B6ES	
L 17 C	B6ES	
L 17 W	BR7EIX	
L 17 Y	BP5ES	8
L 17 YC	BP5ES	8
L 19 C	B5ES	
LR 12 YC	BPR8ES	
LR 12 ZC	BPR8ES	
LR 14 TXS	BUR6ET	1
LR 14 YC	BPR7ES	19
LR 14 ZC	BPR7ES	19
LR 14 ZC 1	BPR7ES-11	
LR 15 TXS	BUR6ET	1
LR 15 YC	BPR6ES	2
LR 15 Z	BPR6ES	2
LR 15 Z 1	BPR6ES-11	13
LR 17 YC	BPR5ES	6
N 08 W	BR10HIX	
N 12 W	BR9HIX	
N 12 Y	BP8HS	

BRISK	→ NGK	V-Line
N 12 YC	BP8HS	
N 14	B8HS	
N 14 C	B8HS	
N 14 Y	BP7HS	
N 14 YC	BP7HS	
N 15	B7HS	
N 15 C	B7HS	
N 15 W	BR8HIX	
N 15 Y	BP6HS	18
N 15 YC	BP6HS	18
N 17	B6HS	
N 17 C	B6HS	
N 17 W	BR7HIX	
N 17 Y	BP5HS	
N 17 YC	BP5HS	
N 19	B5HS	
N 19 C	B5HS	
NR 12 YC	BPR8HS	
NR 15 YC	BPR6HS	3
P 15	BM7A	
P 15 Y	BPM7A	
P 17	BM6A	
P 17 Y	BPM6A	
PR 15 Y	BPMR7A	
PR 17 Y	BPMR6A	
U 15	BM7F	
U 17	BM6F	
UR 17	BMR6F	

**BUICK => GM**

**CADILLAC => GM**

CHAMPION	→ NGK	V-Line
860	A6FS	
2301	BPR5ES-11	
2322	BPR4ES-11	
2332	BPR6ES	2
2338	BKR6ES	28
2415	BPR5ES	6
2430	BKR5E-11	33
3322	BPR5EIX-11	
3344	BKR6EIX-11	
3407	TR5-11X	
5828	BZ7HS-10	
5843	BM7A	
5846	BM6A	
5847	BM6F	
5861	B2-LM	
5883	BR7HS	
5931	BR6HS	
5933	B6HS	



CHAMPION	→ NGK	V-Line
5939	BPR7HS	
88 091	DPR7EA-9	
9 179 100	PFR6G	
9 202 064	BKR6EKUB	
A 4 HC	DP9EA-9	
A 5 YC	DP9EA-9	
A 6	D8EA	
A 6 G	DR8EIX	
A 6 GC	DR8EIX	
A 6 HC	DP8EA-9	
A 6 Y	DP8EA-9	
A 6 YC	DP8EA-9	
A 8	D7EA	
A 8 Y	DP7EA-9	
A 8 YC	DP7EA-9	
A 10	D7EA	
A 50 R	R2525-11	
A 51 R	R2525-10	
A 53 C	R2525-11	
A 53 R	R2525-11	
A 55 C	R2525-10	
A 55 R	R2525-10	
A 55 V	R2349-11	
A 57 CST	R2525-10	
A 57 G	R2525-10	
A 59 C	D9EA	
A 59 G	DR9EIX	
A 59 GC	DCPR9EIX	
A 61	D9EA	
A 61 G	DR9EIX	
BL 4	B7FS	
BL 5	B7FS	
BL 6	BR6FS	
BL 7 Y	BP7FS	
BL 8	BR6FS	
BL 9 Y	BP6FS	
BL 11 Y	BP5FS	
BL 13 Y	BP5FS	
BN 2	B9EFS	
BN 6 Y	BP7EFS	
BN 7 Y	BP6EFS	5
BN 9 Y	BP6EFS	5
BN 12 Y	BP5EFS	
BN 89 Y	BP6EFS	5
C 6 BYC	BCP7ET	
C 6 VPYC	BKR7EIX-11	
C 6 YCC	BCP7ES	
C 7 Y	BCP7ES	
C 7 YC	BCP7ES	
C 7 YCC	BCP7ES	
C 7 YCX	BCP7ES	
C 9 MCC	ZFR5F	

CHAMPION	→ NGK	V-Line
C 9 Y	BCP6ES	17
C 9 YC	BCP6ES	17
C 9 YCC	BCP6ES	17
C 9 YCX	BCP6ES	17
C 10 YCC	BCP6ES	17
C 11 YCC	BCP5ES	16
C 12 YCC	BK5E	
C 55	R7436-10	
C 55 R	R7436-10	
C 57	R7436-9	
C 57 A	R7436-10	
C 57 C	R7436-9	
C 57 CX	R7434-10	
C 57 JC 4	R7436-10	
C 57 YCST	R7436-9	
C 59	R7436-9	
C 59 C	R7436-9	
C 61	R7436-8	
C 281 YC	BCP6ES	17
CJ 3	BM7A	
CJ 4	BM7A	
CJ 6	BM7A	
CJ 6 Y	BPM7A	
CJ 7 Y	BPM7A	
CJ 8	BM6A	
CJ 8 Y	BPM6A	
CJ 11	BM6A	
CJ 14	BM4A	
CJ 17 LM	B4-LM	
CJ 86	BM6A	
D 6	AB-8	
D 9	AB-6	
D 9 J	AB-6	
D 10	AB-6	
D 14	AB-6	
D 16	AB-6	
D 16 J	AB-6	
D 21	AB-6	
D 23	AB-6	
DJ 6 J	BM7F	
DJ 6 Y	BPM7F	
DJ 7 J	BM6F	
DJ 7 Y	BPM6F	
DJ 8 J	BM6F	
EON 1	BKR6ES	28
EON 2	BKR5ES	35
EON 3	BPR5EFS	
EON 4	TR5A-10	
EON 5	BPR6ES	2
EON 6	BPR5ES	6
F 7 Y	AP7FS	
F 7 YC	AP7FS	



CHAMPION	→ NGK	V-Line
F 7 YCC	AP7FS	
F 9 Y	AP6FS	
F 9 YC	AP6FS	
F 10	A6FS	
F 10 C	A6FS	
F 11 Y	AP5FS	
F 11 YC	AP5FS	
F 14 Y	AP5FS	
F 62 Y	AP8FS	
F 81 Y	AP8FS	
F 82	A8FS	
F 83 Y	AP8FS	
FN 507 Y	BCP7ES	
G 1	C9E	
G 2	C8E	
G 54 V	R0045J-10	
G 55	C9E	
G 56 R	R0373A-10	
G 58	C9E	
G 59 C	C7E	
G 61	C8E	
G 63	C8E	
G 63 R	CR8EIX	
H 03	B6S	
H 8	B-6L	
H 8 C	B-6L	
H 8 J	B-6L	
H 10	B-6L	
H 10 C	B-6L	
H 10 J	B-6L	
H 11	B-4L	
H 12	B-4L	
J 4	B7S	
J 4 C	B7S	
J 4 J	B7S	
J 5	B7S	
J 6	B6S	
J 6 C	B6S	
J 6 J	B6S	
J 7	B6S	
J 7 J	B6S	
J 8	B6S	
J 8 C	B6S	
J 8 J	B6S	
J 10 Y	BP6S	
J 11	B-4	
J 11 C	B-4	
J 11 J	B-4	
J 11 Y	BP5S	
J 12 J	B-2	
J 12 Y	BP5S	
J 12 YC	BP5S	

CHAMPION	→ NGK	V-Line
J 13 Y	BP5S	
J 14	B-2	
J 14 J	B-2	
J 14 Y	BP5S	
J 14 YC	BP5S	
J 17 LM	B4-LM	
J 18 Y	BP-4	
J 18 YC	BP-4	
J 19 LM	B2-LM	
K 3 G	AB-8	
K 5 G	AB-8	
K 7	AB-8	
K 8	AB-8	
K 8 G	AB-8	
K 9	AB-7	
K 13	AB-6	
K 15 J	AB-6	
L 2 G	BR9HIX	
L 3 G	BR8HIX	
L 4 G	BR7HIX	
L 4 J	B7HS	
L 5	B7HS	
L 6 G	BR7HIX	
L 6 VC	BU8H	
L 7 J	B6HS	
L 9 G	BR6HIX	
L 9 J	B6HS	
L 10	B6HS	
L 12 Y	BP5HS	
L 14	B-4H	
L 15 Y	BP4HS	
L 19 V	BUH	
L 20 V	BUH	
L 55 G	BR10HIX	
L 61 Y	BP8HS	
L 64 Y	BP7HS	
L 66 Y	BP6HS	18
L 76 V	BUHW	
L 77 J	B7HS	
L 77 J 4	B7HS-10	
L 77 JC	B7HS	
L 77 JC 4	B7HS-10	
L 77 V	BUHW	
L 78	B7HS	
L 78 C	B7HS	
L 78 V	BUHW-2	
L 78 YC	BP7HS-10	
L 78 YC 6	BP8HS-15	
L 81	B7HS	
L 81 Y	BP7HS	
L 82	B6HS	
L 82 C	B6HS	



CHAMPION	→ NGK	V-Line
L 82 Y	BP6HS	18
L 82 YC	BP6HS	18
L 82 YCC	BP6HS	18
L 85	B6HS	
L 85 Y	BP6HS	18
L 86	B6HS	
L 86 C	B6HS	
L 86 CC	B6HS	
L 87 Y	BP6HS	18
L 87 YC	BP6HS	18
L 87 YCC	BP6HS	18
L 90	B5HS	
L 90 C	B5HS	
L 92 LCC	BP5HA	
L 92 Y	BP5HS	
L 92 YC	BP5HS	
L 92 YC 4	BP5HS-10	
L 95 Y	BP4HS	
L 288	B5HS	
N 1	B10ES	
N 1 C	B10ES	
N 2	B9ES	
N 2 C	B9ES	
N 2 G	BR9EIX	
N 3	B8ES	
N 3 C	B8ES	
N 3 G	BR8EIX	
N 4	B7ES	
N 4 C	B7ES	
N 4 G	BR7EIX	
N 4 YC	BP9ES	
N 5	B6ES	
N 5 C	B6ES	
N 5 G	B6EVX	
N 6	B6ES	
N 6 BYC	BUR6ET	1
N 6 GY	BPR8EIX	
N 6 Y	BP8ES	
N 6 YC	BP8ES	
N 6 YCC	BP8ES	
N 7	B7ES	
N 7 BMC	BUR6ET	1
N 7 BYC	BUR6ET	1
N 7 GY	BPR7EIX	
N 7 Y	BP7ES	
N 7 YC	BP7ES	
N 7 YCC	BP7ES	
N 7 YCX	BP7ES	
N 8	B6ES	
N 8 GY	BPR6EIX	
N 8 L	ZGR5C	
N 8 Y	BP6ES	4

CHAMPION	→ NGK	V-Line
N 9 BMC	BPR5EKU	
N 9 BYC	BUR6ET	1
N 9 BYC 4	BP5ET-10	
N 9 Y	BP6ES	4
N 9 YC	BP6ES	4
N 9 YC 4	BP6ES-11	
N 9 YCC	BP6ES	4
N 9 YCE	BP5ES	8
N 9 YCX	BP6ES	4
N 10 PY	BPR6EIX	
N 10 Y	BP6ES	4
N 10 Y 4	BP6ES-11	
N 10 YC	BP5ES	8
N 11 Y	BP5ES	8
N 11 YC	BP5ES	8
N 11 YC 4	BP5ES-11	
N 11 YCC	BP5ES	8
N 12 Y	BP5ES	8
N 12 YC	BP5ES	8
N 12 YCC	BP5ES	8
N 13 L	ZGR5C	
N 13 Y	BP5ES	8
N 14 LY	ZGR5C	
N 14 Y	BP5ES	8
N 16 Y	BP4ES	
N 16 YC	BP4ES	
N 19 V	BUE	
N 21	B4ES	
N 54 R	B10EG	
N 55 G	B105EGV	
N 56 R	B105EGP	
N 57	B10ES	
N 57 G	B105EGV	
N 57 R	B10EG	
N 59 G	B95EGV	
N 60	B9ES	
N 60 R	B8EG	
N 60 Y	BPR10EVX	
N 62 R	B8EG	
N 63 Y	BP9ES	
N 64 Y	BP8ES	
N 65 Y	BP7ES	
N 66 Y	BP6ES	4
N 74 C	BUR6EB-11	
N 79 Y	BP6ES	4
N 80	B10EG	
N 80 G	B11EGV	
N 82	B10EG	
N 82 G	B105EGV	
N 84	B9EG	
N 84 G	B95EGV	
N 86	B9EG	



CHAMPION	→ NGK	V-Line
N 86 G	B9EGV	
N 87	B8EG	
N 87 G	B8EGV	
N 89 GY	BP6ES	4
N 89 Y	BP5ES	8
N 92 Y	BP4ES	
N 178 B	BR8EM	
N 180 B	B7EM	
N 279 YC	BP7ES	
N 281 YC	BP6ES	4
N 288	B5ES	
OBL 9 Y	BPR6FS	
OE 001	BP6ES	4
OE 002	BKR6ES	28
OE 003	BCP6ES	17
OE 004	BPR6ES	2
OE 005	BKR6ES	28
OE 006	BPR6ES	2
OE 007	BP6HS	18
OE 008	BPR7ES	19
OE 009	BP6EFS	5
OE 010	BP7ES	
OE 011	BPR6EFS	7
OE 012	BUR6ET	1
OE 013	BKR5ES	35
OE 014	BCPR7ES	
OE 015	BP5ES	8
OE 016	BKR6ES	28
OE 017	BCP7ES	
OE 018	BPR7ES	19
OE 019	BKR5EK	23
OE 020	BPR6EFS	7
OE 021	BCPR6ET	
OE 022	BP6ES	4
OE 023	BCP6ES	17
OE 024	BKR6E-11	14
OE 025	BUR6ET	1
OE 026	BKR6EK	20
OE 027	BUR5ET-10	21
OE 028	BP5ET-10	
OE 030	BKR6EKC	26
OE 031	PTR5A-13	25
OE 032	BKUR6ET-10	24
OE 033	BKR6EZ	38
OE 034	BKR6ES	28
OE 035	LFR5B	
OE 036	BP6EFS	5
OE 037	B6HS	
OE 038	BP6HS	18
OE 039	BKR6ES-11	14
OE 040	B9ES	
OE 041	ZFR5F	

CHAMPION	→ NGK	V-Line
OE 042	BPR5ES	6
OE 043	BCPR7ES	
OE 044	BUR6ET	1
OE 045	BPR5ES	6
OE 046	BP7ES	
OE 048	BPR6ES-11	13
OE 049	BPR5ES-11	
OE 050	BP7EFS	
OE 051	BPR5ES	6
OE 052	DCPR9EIX	
OE 053	APR6FS	
OE 054	APR6FS	
OE 055	BP5ES	8
OE 056	BKR7ES-11	
OE 057	BCP5ES	16
OE 058	BCP7ES	
OE 059	BP5HS	
OE 060	ZGR5B	
OE 061	AP7FS	
OE 063	BKR6ES-11	14
OE 064	BPR6HS	3
OE 065	BP5ES	8
OE 067	BP7EFS	
OE 068	B8ES	
OE 070	BP6HS	18
OE 071	BPR6HS	3
OE 074	B6ES	
OE 075	BCP7ES	
OE 076	BCP7ET	
OE 077	BCPR6ET	
OE 078	BR8EIX	
OE 079	B7ES	
OE 080	BKR7ES-11	
OE 084	BP8ES	
OE 085	BKR5EKU	
OE 086	BR6HS	
OE 087	BP8ES	
OE 088	BKR5E	35
OE 089	ZFR6F-11	
OE 090	BP7EFS	
OE 091	BR9ES	
OE 092	CR9E	
OE 093	BKR5EZ	36
OE 094	BCPR7ES	
OE 095	BUR6ET	1
OE 096	B6HS	
OE 098	BR7ES	
OE 100	BPR5EKU	
OE 102	BKR6EZ	38
OE 103	DCPR9EIX	
OE 104	BP6HS	18
OE 105	GR4	





CHAMPION	→ NGK	V-Line
OE 106	BP5ES	8
OE 107	BPR7ES-11	
OE 108	BR8ES	
OE 109	BUR6ET	1
OE 110	BCPR7ES	
OE 111	BPR6ES	2
OE 112	DR8EIX	
OE 114	BRE527Y-11	
OE 115	ZFR5N	
OE 116	BPR8ES	
OE 119	BKR6ES	28
OE 120	BKUR5ET-10	
OE 122	PMR7A	
OE 124	PFR5J-11	
OE 125	BR9EIX	
OE 127	BKR5E	35
OE 129	BKR7EIX-11	
OE 130	LZKAR7B	
OE 132	DP8EA-9	
OE 134	PFR5J-11	
OE 136	PFR6J-11	
OE 138	PFR5G-11	
OE 141	BKR6EIX	
OE 143	PFR6G-9	
OE 144	BKUR6ET-10	24
OE 146	PFR5G-13E	
OE 151	BPR5EFS	
OE 152	BKR5E-11	33
OE 154	ZFR5F-11	
OE 155	APR6FS	
OE 156	ZGR5C	
OE 160	ZFR4F-11	
OE 161	GR4	
OE 162	BR6ES	
OE 163	LZTR4A-11	
OE 165	R7436-9	
OE 166	C7E	
OE 167	PLZTR5A-13	
OE 168	TR5IX	
OE 169	R5724-9	
OE 171	BPR6FS	
OE 172	B9EG	
OE 173	R2525-10	
OE 174	PTR5A-13	25
OE 175	LFR5AP-11	
OE 178	LFR5B	
OE 190	IFR5G11	
OE 197	PLKR7A	
OE 198	ZFR6V-G	
OE 199	DCPR8E	
OE 201	LZKR6B-10E	
OJ 11 Y	BP6S	

CHAMPION	→ NGK	V-Line
OJ 12 Y	BP5S	
OJ 13 Y	BP5S	
ON 3	BR8ES	
ON 11 Y	BP5ES	8
ON 12 Y	BP5ES	8
P 6	D10HS	
P 7	D8HA	
P 7 G	DR8HS	
P 7 Y	D8HA	
P 8 Y	D6HA	
P 10 Y	D6HA	
PA 5 HC	D7EA	
PA 7 HC	D7EA	
PG 2 PHP	PMR8A	
PG 4 PHP	PMR7A	
PG 7 C	C7E	
PL 7 YC 4	BP6HS-10	
PL 9 YC	BP6HS	18
PN 5 C	B8ES	
PRL 5 SC	BR6HSA	
PRL 9 SC	BR4HSA	
PRZ 9 HC	CR7HSA	
PZ 7 HC	C7HSA	
PZ 9 HC	C6HSA	
Q 504 V	R2349-10	
QC 9 MC 4	ZFR6F-11	
QC 10 PEPB	IZFR6N-E	
QC 12 PEP	PZFR6H	
QC 12 PEPB	IZFR6N-E	
QC 12 YC	BKR5ES	35
QC 501 V	R7434-10	
QJ 17 LM	BR4-LM	
QJ 19 LM	BR2-LM	
QL 6 VC	BU8H	
QL 7 J 5	BR6HS	
QL 16 V	BUZ8H	
QL 76 V	BUZHW	
QL 77 CC	BR8HS	
QL 77 J 4	BZ7HS-10	
QL 77 JC 4	BZ7HS-10	
QL 78 C	BR7HS	
QL 78 V	BUZHW-2	
QL 78 YC	BPR7HS	
QL 82 C	BR6HS	
QL 82 YC	BPR6HS	3
QL 86	BR6HS	
QL 86 C	BR6HS	
QL 87 YC	BPR6HS	3
QL 92 LCC	BP8HS-10	
QN 2	BR9ES	
QN 2 C	BR9ES	
QN 2 G	BR9EIX	



CHAMPION	→ NGK	V-Line
QN 3	BR8ES	
QN 3 C	BR8ES	
QN 84	BR9EG	
QN 86	BR8EG	
R 6	D8EA	
R 6 G	DR8EIX	
R 6 J	D8EA	
R 8	D7EA	
R 10	D6EA	
R 54 G	R2525-10	
RA 2 HC	DPR7EA-9	
RA 4 HCC	DCPR8E	
RA 4 HCX	DCPR9EIX	
RA 6	DR8ES-L	
RA 6 Y	DPR7EA-9	
RA 6 YC	DPR7EA-9	
RA 7 YC	DCPR8E	
RA 8 GHC	DCPR6E	
RA 8 HC	DCPR7E	
RA 8 Y	DPR7EA-9	
RA 8 YC	DPR7EA-9	
RA 59 GC	DCPR9EIX	
RA 59 PP	DCPR9EIX	
RAX 92 C	DR9EA	
RAX 92 DC	JR9C	
RAX 92 YC	DPR7EA-9	
RAX 94 C	DR8EA	
RAX 94 YC	DPR7EA-9	
RAX 96 C	DR7EA	
RAX 96 YC	DPR7EA-9	
RBL 8	BR6FS	
RBL 9 Y	BPR6FS	
RBL 11 Y	BPR5FS	
RBL 11 Y 6	BPR5FS-15	
RBL 12	BR5FS	
RBL 13 Y	BPR5FS	
RBL 13 Y 6	BPR5FS-15	
RBL 15 Y	BPR4FS	
RBL 15 Y 4	BPR4FS-11	
RBL 15 Y 6	BPR4FS-15	
RBL 16 Y	BPR4FS	
RBL 17 Y	BPR4FS	
RBL 17 Y 6	BPR4FS-15	
RBL 86	BR6FS	
RBL 126	BR5FS	
RBN 9 Y	BPR6EFS	7
RBN 12 Y	BPR5EFS	
RBN 13 Y	BPR5EFS	
RBN 14 Y	BPR5EFS	
RC 6 VPYC	BKR7EIX-11	
RC 6 YC	BCPR7ES	
RC 6 YCC	BCPR7ES	

CHAMPION	→ NGK	V-Line
RC 7 BMC	BCPR6ET	
RC 7 BYC 4	BCPR6ET	
RC 7 GYC	BKR7EIX-11	
RC 7 GYG	BKR6EIX	
RC 7 Y	BCPR7ES	
RC 7 YC	BCPR7ES	
RC 7 YC 4	BKR7ES-11	
RC 7 YCC	BCPR7ES	
RC 7 YCC 4	BKR7ES-11	
RC 8 BYC	BKR6EKC	26
RC 8 DMC	BKR6EK	20
RC 8 PYCB	PFR6G-9	
RC 8 PYP	PFR6J-11	
RC 8 PYP 4	PFR6G-11	
RC 8 PYPB 4	PFR5G-13E	
RC 8 VTYC 4	BKUR6ET-10	24
RC 8 YC	BKR5E	35
RC 8 YC 4	BKR5E-11	33
RC 8 YCC	BKR6ES	28
RC 8 YCL	BKR6ES	28
RC 9 BMC	BKR5EKU	
RC 9 MC 4	ZFR5F-11	
RC 9 MCC 4	ZFR6F-11	
RC 9 TMC	BKR6EKUB	
RC 9 YC	BKR6ES	28
RC 9 YC 4	BKR6ES-11	14
RC 9 YC 5	BKR6E-11	14
RC 9 YCC	BKR6ES	28
RC 9 YCC 4	BKR6E-11	14
RC 9 YCN 4	BKR6E-11	14
RC 10 DMC	BKR5EK	23
RC 10 ECC	ZFR6F-11	
RC 10 MCC	ZFR6V-G	
RC 10 PYC	BKR6EIX	
RC 10 PYP 4	PFR5J-11	
RC 10 PYPB 4	PFR5G-11	
RC 10 YC	BKR5E	35
RC 10 YC 4	BKR6ES-11	14
RC 10 YCC	BKR6ES	28
RC 10 YCL	BKR5EZ	36
RC 11 LCC 4	BRE527Y-11	
RC 11 PYPB 4	PFR5G-11	
RC 12 ECC	ZFR5N	
RC 12 LYC	ZFR5F	
RC 12 MC4	PZFR5F-11	
RC 12 MC 5	ZFR5F-11	
RC 12 MCC 4	ZFR5F-11	
RC 12 PEC5	ZFR5LP-13G	
RC 12 PYP	PFR5J-11	
RC 12 YC	BKR5ES	35
RC 12 YC5	FR45	
RC 14 ES	ZFR5LP-13G	



CHAMPION	→ NGK	V-Line
RC 14 YC	BKR5ES	35
RC 14 YC 4	BKR5E-11	33
RC 87 PYC	BKUR6ET-10	24
RC 87 YC	BKR6ES	28
RC 87 YCC	BKR6EZ	38
RC 87 YCL	BKR6EZ	38
RC 89 TMC	BKUR5ET-10	
RC 89 YCC	BKR5EZ	36
RC 503 C	R7433-8	
RCJ 4	BMR7A	
RCJ 6	BMR7A	
RCJ 6 Y	BPMR7A	
RCJ 7 Y	BPMR7A	
RCJ 8	BMR6A	
RCJ 8 Y	BPMR6A	
RCJ 501 H	BPMR4A	
RD 9	AB-6	
RD 14	AB-6	
RD 16	AB-6	
RD 16 J	AB-6	
RDJ 6 J	BM7F	
RDJ 7 J	BMR6F	
RDJ 7 Y	BPMR6F	
RDJ 8 J	BMR6F	
RE 7 PYC 5	PTR5A-13	25
RE 7 YCC	PTR5A-13	25
RE 10 LC	TR5-1IX	
RE 10 PMC 5	PTR5A-13	25
RE 10 YC 4	BKR5ES-11	33
RE 14 MCC 4	LZTR4A-11	
RE 14 MCC 4 T 04	LZTR4A-11	
RE 14 MCC 5	LZTR4A-11	
RE 14 PLP 5	PLZTR5A-13	
REA 8 MCL	LZKAR7A	
REA 8 MX	LZKAR7B	
REA 12 WMB 4	LZKAR6AP-11	
REC 9 MCLX	LFR5B	
REC 9 YCL	LFR5B	
REC 10 PYC 4	LFR5AP-11	
REC 10 WYPB 4	IFR5G11	
RER 8 MC	LZKR6B-10E	
RER 8 YC	PLKR7A	
RES 9 YCC 4	PTR5A-13	25
RF 7 YC	APR6FS	
RF 7 YCC	APR6FS	
RF 9 Y	APR6FS	
RF 9 Y 5	APR6FS	
RF 9 YC	APR6FS	
RF 10	AR6FS	
RF 10 C	AR6FS	
RF 11 Y	APR6FS	
RF 11 YC	APR6FS	

CHAMPION	→ NGK	V-Line
RF 14 Y	APR5FS	
RFN 14 LY	ZFR4F-11	
RG 2 PHP	CR8EIX	
RG 4 HC	CR9E	
RG 4 PHP	PMR7A	
RG 6 YC	CR8EB	
RG 6 YCA	CPR8E	
RG 6 YCH	CPR8E	
RG 92 C	CR9E	
RG 92 DC	CR9EK	
RG 94 C	CR8E	
RGU 92 C	CR9EH-9	
RGU 94 C	CR8EH-9	
RH 10 C	B-6L	
RH 18 Y	B-4L	
RJ 6	BR6S	
RJ 6 C	BR6S	
RJ 6 J	BR6S	
RJ 7	BR6S	
RJ 8	BR6S	
RJ 8 C	BR6S	
RJ 8 J	BR6S	
RJ 10 Y	BP6S	
RJ 11	BR6S	
RJ 11 Y	BP5S	
RJ 12	BR6S	
RJ 12 Y	BP5S	
RJ 12 YC	BP5S	
RJ 14 CC	XR4	
RJ 14 Y	BP5S	
RJ 14 YC	BP5S	
RJ 17 LM	BR4-LM	
RJ 18 Y	BP-4	
RJ 18 YC	BP-4	
RJ 18 YC 6	XR45IX	
RJ 19 LM	BR2-LM	
RJ 20 Y	BP-4	
RL 4 J	BR7HS	
RL 7 J	BR6HS	
RL 12 Y	BPR6HS	3
RL 19	BR5HS	
RL 77 J	BR7HS	
RL 78	BR7HS	
RL 78 C	BR7HS	
RL 82	BR6HS	
RL 82 C	BR6HS	
RL 82 Y	BPR6HS	3
RL 82 YC	BPR6HS	3
RL 82 YCC	BPR6HS	3
RL 85	BR6HS	
RL 86	BR6HS	
RL 86 C	BR6HS	



CHAMPION	→ NGK	V-Line
RL 87 Y	BPR6HS	3
RL 87 YC	BPR6HS	3
RL 90	BR5HS	
RL 95 YC	BPR5HS	
RN 1 C	BR10ES	
RN 2	BR9ES	
RN 2 C	BR9ES	
RN 2 G	BR9EIX	
RN 3	BR8ES	
RN 3 C	BR8ES	
RN 3 G	BR8EIX	
RN 4	BR7ES	
RN 4 C	BR7ES	
RN 5	BR6ES	
RN 5 C	BR6ES	
RN 6	BR6ES	
RN 6 Y	BPR8ES	
RN 6 YC	BPR8ES	
RN 7 GY	BPR7EIX	
RN 7 Y	BPR7ES	19
RN 7 YC	BPR7ES	19
RN 7 YCC	BPR7ES	19
RN 7 YCC 4	BPR7ES-11	
RN 8	BR5ES	
RN 8 L	ZGR5C	
RN 8 VTYC 4	BUR6ET	1
RN 9 BMC	BPR5EKU	
RN 9 GY	BPR6EIX	
RN 9 LCC	ZGR5B	
RN 9 Y	BPR6ES	2
RN 9 YC	BPR6ES	2
RN 9 YC 4	BPR6ES-11	13
RN 9 YCC	BPR6ES	2
RN 10 GY	BPR6EIX	
RN 10 PYP 4	PGR5A-11	
RN 10 VTYC	BUR5ET	22
RN 10 VTYC 4	BUR5ET-10	21
RN 10 Y	BPR6ES	2
RN 10 Y 4	BPR6ES-11	13
RN 10 YC	BPR6ES	2
RN 11 Y	BPR5ES	6
RN 11 YC	BPR5ES	6
RN 11 YC 4	BPR5ES-11	
RN 11 YCC	BPR5ES	6
RN 12 GY	BPR5EIX	
RN 12 MC 4	BPR4EY-11	
RN 12 Y	BPR5ES	6
RN 12 YC	BPR5ES	6
RN 12 YC 4	BPR5ES-11	
RN 12 YC 6	BPR5ES-13	
RN 12 YCC	BPR5ES	6
RN 13 L	ZGR5C	

CHAMPION	→ NGK	V-Line
RN 13 LYC	ZGR5C	
RN 14 LY	ZGR5C	
RN 14 MC 5	BPR4EY-11	
RN 14 PMP 5	GR4	
RN 14 Y	BPR5ES	6
RN 14 Y 6	BPR5ES-13	
RN 14 YC	GR4	
RN 16 Y	BPR4ES	
RN 16 YC 5	BPR4ES-13	
RN 16 YC 6	BPR4EY-11	
RN 57 YC	BR10EG	
RN 74 C	BUR6EB-11	
RN 180 B	BR7EM	
RP 7	DR8HS	
RP 10 HC	DR5HS	
RS 5 C	BR7EFS	
RS 9 YC	BPR6EFS	7
RS 9 YCC	BPR6EFS	7
RS 10 LC	TR5-1	
RS 12 PYP	TR5IX	
RS 12 YC	BPR5EFS	
RS 12 YC 6	BPR5EFS-13	
RS 13 LYC	TR4	
RS 14 LC	TR5-1	
RS 14 LYC	TR4	
RS 14 PYP	TR4IX	
RS 14 YC	BPR5EFS	
RS 14 YC6	TR55IX	
RS 15 LYC	TR4	
RS 16 YC	TR4	
RV 8 C	BR6FS	
RV 8 C 6	BR6FS	
RV 9 YC	BPR6FS	
RV 12 C	BR5FS	
RV 12 C 6	BR5FS	
RV 12 YC	BPR5FS	
RV 12 YC 6	BPR5FS-15	
RV 15 YC	BPR4FS	
RV 15 YC4	BPR4FS-11	
RV 15 YC6	BPR4FS-15	
RV 17 YC	BPR4FS	
RV 17 YC6	BPR4FS-15	
RV 91 MC	BR6FS	
RV 92 YC	BPR5FS	
RZ 7 C	CMR7H	
RZ 94 C	CR8HSA	
RZ 96 C	CR7HSA	
RZN 12 Y	BPR5EFS	
RZN 12 Y 5	BPR5EFS	
S 6 YC	BP7EFS	
S 7 YC	BP7EFS	
S 7 YCC	BP7EFS	



CHAMPION	→ NGK	V-Line
S 9 YC	BP6EFS	5
S 9 YCC	BP6EFS	5
S 59 C	R5724-9	
S 59 CST	R5724-9	
S 279 YC	BP6EFS	5
S 281 YC	BP6EFS	5
S 379 YC	BP7EFS	
UD 16	AB-6	
UF 9 Y	AP6FS	
UF 11 Y	AP6FS	
UJ 2 J	B8S	
UJ 4 J	B7S	
UJ 6	B6S	
UJ 8	B6S	
UJ 12	B-2	
UJ 81 C	B7S	
UJ 81 J	B7S	
UK 10	AB-6	
UL 4 J	B7HS	
UL 17 V	BUHXW-1	
UL 18 V	BUHX	
UL 77 V	BUHXW-1	
UL 81 C	B7HS	
UL 81 J	B7HS	
UL 82 Y	BP7HS	
UN 19 V	BUE	
UN 79 Y	BP6ES	4
V 4 C	B7FS	
V 9 YC	BP6FS	
V 12 YC	BP5FS	
V 61	R5673-8	
V 63 C	R5673-7	
XC 12 PEPB	PZFR6H	
XC 92 YC	BKR5E	35
XJ 10 Y	BP6S	
Y 82	CM-6	
Z 6	C8HSA	
Z 7 G	CR7HIX	
Z 8	C7HSA	
Z 9 Y	C7HSA	
Z 10	C6HSA	
Z 10 G	CR7HIX	
Z 12	C6HSA	
<b>CHEVROLET =&gt; GM</b>		
<b>CHRYSLER → NGK V-Line</b>		
04606 402 AB	LZTR4A-11	
04606 591 AB	ZFR5LP-13G	
04886 204	BP5HS	
04886 205	BP5ES-A	

CHRYSLER	→ NGK	V-Line
04886 206	BP6ES	4
04886 207	BP5FS	
04886 208	BP4FS	
04886 210	BP5EFS	
04886 211	TR4	
04886 213	BPR5ES-11	
04886 214	BPR4ES-11	
04886 215	BCPR5ES	32
04886 217	BPR5ES-A	
04886 219	BKR6ES	28
04887 030	ZFR5F-11	
04887 031	BKR5ES-11	33
04887 032	PFR5J-11	
S2LZT R4A 11	LZTR4A-11	
<b>CITROËN =&gt; PSA</b>		
<b>DACIA =&gt; RENAULT</b>		
<b>DAEWOO =&gt; GM</b>		
<b>DAIHATSU → NGK V-Line</b>		
90048-51006-000	B8ES	
90048-51008-000	B7ES	
90048-51015-000	B6ES	
90048-51020-000	B-4H	
90048-51022-000	B6HS	
90048-51033-000	B5ES	
90048-51034-000	BP6ES	4
90048-51034-010	BP6ES	4
90048-51035-000	BP6EY	
90048-51038-000	B6ES	
90048-51039-000	BPR6EK-A	
90048-51040-000	BPR6EK-A	
90048-51041-000	BPR6EY	
90048-51044-000	BPR5EY	9
90048-51047-010	BP5EY	
90048-51048-000	BPR5EY	9
90048-51049-000	BPR4EY-11	
90048-51050-000	BPR5EY-11	
90048-51053	BP5EY	
90048-51053-000	BP5EY	
90048-51054	BPR5EY	9
90048-51054-000	BPR5EY	9
90048-51055-000	BP6ES	4
90048-51058-000	BE527Y-11	
90048-51059	BPR6EY	
90048-51059-000	BPR6EY	
90048-51062-000	BPR5EY-11	
90048-51063	BPR5EY-11	
90048-51063-000	BPR5EY-11	
90048-51069-000	BP6EY	





DAIHATSU	→ NGK	V-Line
90048-51072-000	BP5ES	8
90048-51073-000	BPR6EK-A	
90048-51074-000	BPR6EK-A	
90048-51077-000	BPR6EKN	
90048-51079-000	BKR7E-11	
90048-51081-000	BPR5EY-11	
90048-51082-000	BPR5EY	9
90048-51084-000	BPR7EKN	
90048-51086-000	BPR6EK-A	
90048-51087-000	BPR6EK-A	
90048-51091-000	BPR5EY-11	
90048-51092-000	BPR6EY-11	10
90048-51093-000	BPR5EY-11	
90048-51093-A	BPR5EY-11	
90048-51095-000	BPR6ES	2
90048-51096-000	BPR6ES	2
90048-51097	BP-2E	
90048-51097-000	BP-2E	
90048-51099-000	BKR6E-11	14
90048-51100	BKR6E-11	14
90048-51100-000	BKR6E-11	14
90048-51101-000	BPR5EY	9
90048-51102-000	BPR6EKN	
90048-51103-000	BPR7EKN	
90048-51104-000	BPR6EKN	
90048-51105-000	BPR7EKN	
90048-51107-000	BPR6EKB-L	
90048-51108-000	BPR6EKB-L	
90048-51108-1	BPR6EKB-L	
90048-51110-000	BCPR7EKD	
90048-51111-000	BCPR6ED	
90048-51112	BCPR7EKD	
90048-51112-000	BCPR7EKD	
90048-51113	BCPR6ED	
90048-51113-000	BCPR6ED	
90048-51114	BPR5ES	6
90048-51114-000	BPR5ES	6
90048-51115-000	BPR6EKB-L	
90048-51116	BPR6EKB	
90048-51116-000	BPR6EKB	
90048-51117-000	PFR6B-11	
90048-51118-000	PFR6B-11	
90048-51121-000	BPR4EY	
90048-51123	BKR6EY-11	
90048-51123-000	BKR6EY-11	
90048-51125-000	BPR5EJ	
90048-51126	BPR5EJ	
90048-51126-000	BPR5EJ	
90048-51130-000	BPR5EKB	
90048-51131	BPR5EKB	
90048-51131-000	BPR5EKB	
90048-51131-1	BPR5EKB	

DAIHATSU	→ NGK	V-Line
90048-51133-000	BCPR6EKD	
90048-51134	BCPR6EKD	
90048-51134-000	BCPR6EKD	
90048-51134-1	BCPR6EKD	
90048-51136-000	BKUR6EK	
90048-51137	BKUR6EK	
90048-51137-000	BKUR6EK	
90048-51140	BPR6EKB	
90048-51143-000	BKUR7EK	
90048-51144	BKUR7EK	
90048-51144-000	BKUR7EK	
90048-51145	BKR4E	
90048-51151-000	BKR6E	28
90048-51152	BKR6E	28
90048-51152-000	BKR6E	28
90048-51154-000	BKR6EKC	26
90048-51155	BKR7EKC	
90048-51155-000	BKR6EKC	26
90048-51156-000	R7433-9	
90048-51158-000	BKR5E-11	33
90048-51158-008	BKR5E-11	33
90048-51159-000	BKUR6EK-9	
90048-51160	BKUR6EK-9	
90048-51160-000	BKUR6EK-9	
90048-51161	BKR7E	
90048-51161-000	BKR7E	
90048-51162	IFR7F-6D	
90048-51162-000	PFR7N-D	
90048-51163-000	BKR6EYA-11	
90048-51165	BKR5EKC	
90048-51165-000	BKR5EKC	
90048-51166	PFR6G	
90048-51166-000	PFR6G	
90048-51167-000	BKR6EIX-P	
90048-51168	BKUR6ETB-10	
90048-51168-000	BKUR6ETB-10	
90048-51169-000	BKUR6ETB-10	
90048-51172-000	BKR6EIX-11P	
90048-51173	IFR6J11	
90048-51173-000	IFR6J11	
90048-51175-000	BKR6EKPA	
90048-51185-000	ILFR6T11	
90048-51187	IKR7C	
90048-51196	DCPR7EA-9	
90048-51200	IKR7D	
90919-01026-000	BP5EY	
90919-01056-000	BP4EY	
90919-01059-000	BP5EY	
90919-01060-000	BP4EY	
90919-01061-000	BP5EY	
90919-01065-000	BPR4EY	
90919-01085-000	BP4EY-11	



DAIHATSU	→ NGK	V-Line
90919-01086-000	BP4EY-11	
90919-01087-000	BP5EK-A	
90919-01106-000	BP4EY-11	
90919-01115-000	BPR5EP-11	
90919-01116-000	BPR5EP-11	
90919-01117-000	BE529Y-11	
90919-01118-000	BE529Y-11	
90919-01177-000	BKR5EYA	
90919-01181-000	BKR6EP-8	
90919-01202-000	BKR6EKB-11	
99113-39236-10	AB-6	
99113-39236-200	AB-6	
99123-11236-100	AB-7	
99123-11236-220	AB-7	
99251-30200-100	B-4	
99520-21236-132	B8HS	
99906-850P9-006	BPR6HS	3
99906-850P9-009	BR7ES	
99906-850P9-011	BPR5ES-11	
99906-850P9-012	BPR6ES-11	13
99906-850P9-013	BPR5ES-13	
99906-850P9-015	BPR5EIX-11	
99906-850P9-017	BRE527Y-11	
99906-850P9-018	BRE529Y-11	
99906-910P9-002	BR6HS	
99906-910P9-003	BR8HS	
99906-910P9-004	BPR5HS	
99906-910P9-005	BPR6HS	3
99906-910P9-006	BR5ES	
99906-910P9-007	BR6ES	
99906-910P9-008	BR7ES	
99906-910P9-009	BR8ES	
99906-910P9-011	BPR5ES-11	
99906-910P9-012	BPR6ES-11	13
99906-910P9-013	BPR5EIX-11	
99906-910P9-015	BPR4EY-11	
99906-910P9-017	BPR6EY-11	10
99906-910P9-020	BPR6E	2
99906-910P9-021	BCPR5E-11	
99906-910P9-022	BCPR5EY-11	
99906-910P9-023	BCPR6E-11	11
99906-910P9-024	BCPR6EY-11	
99906-910X9-001	BPR5EIX-11	
99906-910X9-002	BPR6EIX-11	
99906-910X9-003	BPR7EIX	
99906-910X9-004	BCPR5EIX-11	
99906-910X9-005	BCPR6EIX-11	
99906-910X9-006	BKR5EIX-11	
99906-910X9-007	BKR6EIX-11	
99906-910X9-008	BPR6HIX	
99906-910X9-009	BPR7HIX	
99906-910X9-010	BR6HIX	

DAIHATSU	→ NGK	V-Line
99906-910X9-011	BR7HIX	
99906-910X9-012	BR8EIX	
99906-910X9-013	BR9EIX	
99906-910X9-014	DR8EIX	
99906-910X9-015	DR9EIX	
99906-910X9-016	DPR8EIX-9	
99906-910X9-017	DPR9EIX-9	
99906-910X9-018	DCPR7EIX	
99906-910X9-019	ZFR5FIX-11	
99906-910X9-020	ZFR6FIX-11	
99906-910X9-021	CR8EHIX-9	
99906-910X9-022	CR9EHIX-9	
99906-910X9-023	CR8EIX	
99906-910X9-024	B8HCS	
99906-910X9-025	IRIWAY7	
99906-910X9-026	BPR5EIX	
99906-910X9-027	BPR6EIX	
99906-910X9-028	BKR5EIX	
99906-910X9-029	BKR6EIX	
99906-910X9-030	BKR7EIX-11	
99906-910X9-032	BKR5EIX-P	
99906-910X9-033	BKR5EIX-11P	
99906-910X9-034	BKR6EIX-P	
99906-910X9-035	BKR6EIX-11P	
99934-00691-100	BPR6EIX	
99934-01691-100	BPR5EIX	
99934-02691-100	B6EVX	
99934-03691-100	BR7EIX	
99934-05691-100	BP5ES-11	
99934-06691-100	BP6ES-11	
99934-07685-100	BP5EY-11	
99934-07691-100	BP5HS	
99934-08685-100	BP6EY-11	
99934-08691-100	BP5ES-13	
99934-09685-100	BP6HS	18
99934-09691-100	BP6HS	18
99934-10685-100	BP-2E	
99934-10691-100	BP4EY	
99934-12685-100	BP5HS	
99934-13685-100	BP6ES-11	
99934-14685-100	BP5ES-13	
NDIK 16	BKR5EIX-11	
NDIK 16 A	BKR5EIX-11	
NDIK 20	BKR6EIX-11	
NDIK 20 A	BKR6EIX-11	
NDIK 22	IRIWAY7	
NDIK 22 A	IRIWAY7	
NDIK 24 A	IRIWAY8	
NDIK 27 A	IRIWAY9	
NDIQ 16	BCPR5EIX-11	
NDIQ 16 A	BCPR5EIX-11	
NDIQ 20	BCPR6EIX-11	



<b>DAIHATSU</b>	<b>→ NGK</b>	<b>V-Line</b>
NDIQ 20 A	BCPR6EIX-11	
NDIQ 22	IRITOP7	
NDIQ 22 A	IRITOP7	
NDIQ 24 A	IRITOP8	
NDIQ 27 A	IRITOP9	
NDIW 16	BPR5EIX-11	
NDIW 16 A	BPR5EIX-11	
NDIW 20	BPR6EIX-11	
NDIW 20 A	BPR6EIX-11	
NDIW 22	BPR7EIX	
NDIW 22 A	BPR7EIX	
NDIXU 22	DCPR7EIX	
NDIXU 22 A	DCPR7EIX	
NDVK 16	BKR5EIX-11P	
NDVK 16 A	BKR5EIX-11P	
NDVK 20	BKR6EIX-11P	
NDVK 20 A	BKR6EIX-11P	
NDVK 22	BKR7EIX-P	
NDVK 22 A	BKR7EIX-P	
NDVQ 16	BCPR5EIX-11P	
NDVQ 16 A	BCPR5EIX-11P	
NDVQ 20	BCPR6EIX-11P	
NDVQ 20 A	BCPR6EIX-11P	
NDVXU 22	DCPR7EIX-P	
NDVXU 22 A	DCPR7EIX-P	

<b>DENSO</b>	<b>→ NGK</b>	<b>V-Line</b>
FK 20 HBR 11	DFH6B-11A	
FXE 20 HR 11	DILKAR6A11	
FXE 22 HR 11	DF7H-11B	
FXE 24 HR 11	DF8H-11B	
IA 0132	R7282A-105	
IA 0134	R7282A-11	
IAE 0132	R7282-105	
IAE 0134	R7282-11	
IK 16	BKR5EIX-11	
IK 20	BKR6EIX-11	
IK 22	IRIWAY7	
IK 24	IRIWAY8	
IK 24 C11	FR8BI-11	
IK 27	IRIWAY9	
IK 27 C11	FR9BI-11	
IK 0124	R7434-8	
IK 0127	R7434-9	
IK 0131	R7434-10	
IK 0224	R7434-8	
IK 0227	R7434-9	
IK 0231	R7434-10	
IKH 16	LFR5AIX-11	
IKH 20	LFR6AIX-11	
IKH 0124	R7438-8	

<b>DENSO</b>	<b>→ NGK</b>	<b>V-Line</b>
IKH 0127	R7438-9	
IKH 0131	R7438-10	
IQ 16	BCPR5EIX-11	
IQ 20	BCPR6EIX-11	
IQ 22	IRITOP7	
IQ 24	IRITOP8	
IQ 27	IRITOP9	
IQ 0124	R7436-8	
IQ 0127	R7436-9	
IQ 0131	R7436-10	
IQ 0224	R7436-8	
IQ 0227	R7436-9	
IQ 0231	R7436-10	
IRE 0134	R7420-11	
IT 16	TR5IX	
IT 20	TR6IX	
IT 22	TR7IX	
IT 24	TR8IX	
ITF 16	UR5IX	
ITF 20	UR6IX	
IU 22	CR7EIX	
IU 24	CR8EIX	
IU 27	B8HCS	
IU 27 D	CR9EIA-9	
IU 0127	R0373A-9	
IU 0131	R0373A-10	
IU 0134	R0373A-11	
IUF 22	CR7HIX	
IUF 24	CR8HIX	
IUH 24	CR8EHIX-9	
IUH 27	CR9EHIX-9	
IUH 27 D	IMR9A-9H	
IW 16	BPR5EIX-11	
IW 20	BPR6EIX-11	
IW 22	BPR7EIX	
IW 24	BR8EIX	
IW 27	BR9EIX	
IW 31	BR10EIX	
IW 0124	R7376-8	
IW 0127	R7376-9	
IW 0131	R7376-10	
IW 0627	R7376-9	
IW 0631	R7376-10	
IWF 20	BPR6HIX	
IWF 22	BR7HIX	
IWF 24	BR8HIX	
IWF 27	BR9HIX	
IWM 24	BR8ECMIX	
IWM 27	BR9ECMIX	
IWM 31	BR10ECMIX	
IWM 0132	R7282-105	
IX 22 B	DPR7EIX-9	



DENSO	→ NGK	V-Line
IX 24	DR8EIX	
IX 24 B	DPR8EIX-9	
IX 27	DR9EIX	
IX 27 B	DPR9EIX-9	
IXU 22	DCPR7EIX	
IXU 22 C	KR7AI	
IXU 0127	R2525-9	
IXU 0131	R2525-10	
IXU 0134	R2349-11	
IY 24	ER8EHIX	
IY 27	ER9EHIX	
J 16 ARU 11	BRE527Y-11	
J 16 AU 11	BE527Y-11	
J 16 AY	BPR5EY-11	
J 16 AYR	BPR5EJ	
J 16 BRU	BRE529Y	
J 16 BRU 11	BRE529Y-11	
J 16 BU 11	BE529Y-11	
J 16 CRU	ZGR5A	15
J 16 CU	BPR5EY	9
J 20 AY	BPR6EY-11	10
K 14 PRU 11	BKR4E-11	
K 14 PU 11	BKR5E-11	33
K 16 DTRS 11	ZFR5G	
K 16 GPRU 11	ZFR5E-11	
K 16 HPRU 11	LFR5A-11	
K 16 PRL 11	BKR5E-N-11	
K 16 PRP 11	BKR5EIX	
K 16 PRTP 11	BKR5EIX-11	
K 16 PRU	BKR5E	35
K 16 PR-U 11	BKR5E-11	33
K 16 PRUR	BKR5E	35
K 16 PRZU 11	BKR5EIX-11	
K 16 PSR-B 8	FR5EI	
K 16 PU	BK5E	
K 16 PU 11	BK5E-11	
K 16 RU	BKR5EYA	
K 16 RU 11	BKR5EYA-11	39
K 16 RZU 11	BKR5EIX-11	
K 16 TNRS 9	BKR5EKC	
K 16 TR 11	BKR5EKB-11	
K 16 U	BKR5EYA	
K 16 U 11	BKR5EYA-11	39
K 20 DTRS 11	ZFR6G	
K 20 HRU	LFR6B	
K 20 HRU 11	LFR6C-11	
K 20 PBR	BKUR6ET	27
K 20 PBRS 10	BKUR6ET-10	24
K 20 PRL 11	BKR6E-N-11	
K 20 PRTP 11	BKR6EIX-11	
K 20 PRU	BKR6E	28
K 20 PRU 11	BKR6E-11	14

DENSO	→ NGK	V-Line
K 20 PRU 9 S	BKR6E-9S	
K 20 PRUR	BKR6E	28
K 20 PRZU 11	BKR6EIX-11	
K 20 PSR-B 8	FR6EI	
K 20 PU	BK6E	
K 20 PU 11	BK6E-11	
K 20 RU	BKR6EYA	
K 20 RU 11	BKR6EY-11	
K 20 RZ	BKR6EIX	
K 20 RZU 11	BKR6EIX-11	
K 20 TMR 11	BKR6EKC-N-11	
K 20 TNR	BKR6EKC	26
K 20 TNRS	BKUR6EK	
K 20 TNRS 9	BKUR6EK-9	
K 20 TR 11	BKR6EKB-11	
K 20 TRX	BKR6EKU	
K 20 TXR	BKR6EKUB	
K 20 U	BKR6EYA	
K 20 U 11	BKR6EYA-11	
K 22 P 11	BK7EK-N-11	
K 22 PB	BCP7ET	
K 22 PBRS	BKUR7ET	
K 22 PRL 11	BKR7E-N-11	
K 22 PRTP 11	BKR7EIX-11	
K 22 PRU	BKR7E	
K 22 PRU 11	BKR7E-11	
K 22 PRUR	BKR7E	
K 22 PRZU	BKR7EIX	
K 22 PRZU 11	BKR7EIX-11	
K 22 PU 11	BK7E-11	
K 22 TM 11	BK7EK-N-11	
K 22 TMR	BKR7EKC-N	
K 22 TMR 11	BKR7EKC-N-11	
K 22 TNR	BKR7EKC	
K 22 TNRS	BKUR7EK	
K 24 PRU 11	BKR8E-11	
K 29 AZ	R7434-10	
KJ 14 CR 11	ZFR4F-11	
KJ 14 CRL 11	ZFR4F-11	
KJ 16 CR	ZFR5F	
KJ 16 CR 11	ZFR5J-11	
KJ 16 CRL 11	ZFR5F-11	
KJ 16 CRU 11	ZFR5F-11	
KJ 20 CR 11	ZFR6J-11	
KJ 20 CRL 11	ZFR6F-11	
KJ 20 CRU 11	ZFR6F-11	
KJ 20 DRM 11	ZFR6K-11	
KJ 20 SR 11	ZFR6FIX-11	
KJ 22 CR 11	ZFR7F-11	
KJ 22 CRL 8	ZFR7F	
KJ 22 CRL 11	ZFR7F-11	
KJ 206 CRL 11	ZFR6F-11	



DENSO	→ NGK	V-Line
L 14 U	AB-6	
M 17	AB-6	
M 22	AB-7	
M 24 S	AB-8	
MA 14 PU	AP5FS	
MA 16 PRU	APR5FS	
MA 16 PRU 11	APR5FS	
MA 16 PRU 15	APR5FS	
MA 16 PU	AP5FS	
MA 17 PU	AP6FS	
MA 20 PRU	APR6FS	
MA 20 PU	AP6FS	
MA 20 RU	AR6FS	
MA 20 RU 11	AR6FS	
MW 9	AB-2	
MW 17	AB-6	
MW 22	AB-7	
P 16 PR 8	PGR5A	
P 16 PR 11	PGR5A-11	
P 16 R	BPR5EP-11	
P 16 R 13	BPR5EP-11	
P 20 PR 8	PGR6A	
P 20 PR 11	PGR6A-11	
P 20 R 8	BPR6EP-8	
P 22 PR 8	PGR7A	
PK 16 PR 11	PFR5B-11	
PK 16 PRL 11	PFR5G-11	
PK 16 PRP 11	PFR5J-11	
PK 16 R 11	BKR5EP-11	
PK 16 TR 11	BKR5EKP-11	
PK 16 TR 13	BKR5EKP-13	
PK 20 GR 8	BKR6EPA-8	
PK 20 PR 11	PFR6B-11	
PK 20 PRL 11	PFR6G-11	
PK 20 PRL 13	PFR6G-13	
PK 20 PRP	PFR6J	
PK 20 PRP 8	PFR6J	
PK 20 PRP 11	PFR6J-11	
PK 20 PRTP	PFR6M	
PK 20 PTRS 9	BKR6EKPA	
PK 20 R 8	BKR6EP-8	
PK 20 R 11	BKR6EP-11	
PK 20 R 13	BKR6EP-13	
PK 20 RP 8	BKR6EP-N-8	
PK 20 TR 11	BKR6EKP-11	
PK 22 PR 8	PFR7B	
PK 22 PR 11	PFR7B-11	
PK 22 PRL 11	PFR7G-11	
PK 22 PRL 11S	PFR7G-11S	
PK 22 PRTP	PFR7M	
PKJ 16 CR 8	PZFR5F	
PKJ 16 CRL 11	PZFR5F-11	

DENSO	→ NGK	V-Line
PKJ 16 CRL 13	PZFR5F-13	
PKJ 20 CR 8	PZFR6F	
PKJ 20 CRL 11	PZFR6F-11	
PKJ 20 CRM 11	PZFR6F-11	
PQ 16 R	BCPR5EIX-11	
PQ 16 R 8	BCPR5EP-8	
PQ 16 R 13	BCPR5EIX-11	
PQ 20 R	BCPR6EP-11	
PQ 20 R 8	BCPR6EP-8	
PQ 20 R 13	BCPR6EIX-11	
PQ 20 RP 8	BCPR6EP-N-8	
PQ 20 RP 11	BCPR6EIX-11	
PT 16 EPRC 13	PTR5C-13	
PT 16 EPRL 13	PTR5D-10	31
PT 16 VR 13	PTR5A-13	25
PTJ 16 R 15	PZTR5A-15	
Q 14 RU 11	BCPR4EY-11	
Q 16 PRTP 11	BCPR5EIX-11	
Q 16 PRU	BCPR5E	32
Q 16 PRU 11	BCPR5EY-11	
Q 16 PRUL 11	BCPR5EY-N-11	
Q 16 PRZU 11	BCPR5EIX-11	
Q 16 PU 11	BCPR5EY-11	
Q 16 RU	BCPR5EY	
Q 16 RU 11	BCPR5EY-11	
Q 16 RZU 11	BCPR5EIX-11	
Q 16 U11	BCPR5EY-11	
Q 16 ZU 11	BCPR5EIX-11	
Q 20 PRP 11	BCPR6EIX-11	
Q 20 PRU	BKR6E	28
Q 20 PRU 11	BCPR6EY-11	
Q 20 PRUL 11	BCPR6EY-N-11	
Q 20 PRZU 11	BCPR6EIX-11	
Q 20 PU	BCP6ES	17
Q 20 PU 11	BKR6E-11	14
Q 20 RU	BCPR6EY	
Q 20 RU 11	BCPR6EY-11	
Q 20 RZU 11	BCPR6EIX-11	
Q 20 U	BCP6E	17
Q 20 U 11	BKR6E-11	14
Q 20 ZU 11	BCPR6EIX-11	
Q 22 PRP 11	BKR7EIX-11	
Q 22 PRU	BCPR7ES	
Q 22 PRU 11	BCPR7ES-11	
Q 22 PRUL 11	BCPR7EY-N-11	
Q 22 PRZU	BCP7EVX	
Q 22 PRZU 11	BKR7EIX-11	
Q 22 PU	BCP7ES	
Q 22 PU 11	BKR7E-11	
Q 27 AZ	R7435-9	
QJ 16 ARU	BCRE527Y	
QJ 16 C11	ZFR5A-11	





DENSO	→ NGK	V-Line
QJ 16 CR 11	ZFR5A-11	
QJ 20 C11	ZFR6A-11	
QJ 20 CR 11	ZFR6A-11	
QJ 22 CR 11	ZFR7F-11	
QL 20 PRU	BCPR6ED	
QL 20 TRS	BCPR6EKD	
QL 22 TRS	BCPR7EKD	
RU 0131	R0045Q-10	
RU 0134	R0045Q-11	
S 22 PRA 7	IGR7A	
S 27	SD9A	
S 29	SD10A	
S 29 A	SD10A	
S 31 A	SD11A	
SC 20 HR 11	ILKAR7B11	
SD 29 A	SD10A	
SF 10	BUHX	
SF 24	BU8H	
SF 50	BUHW	
SF 51	BUHW-2	
SK 16 HR 11	ILFR5T11	
SK 16 PR-A11	IFR5E11	
SK 16 PR-E11	IFR5E11	
SK 16 PR-E13	IFR5E13	
SK 16 PR-L11	IFR5G-11K	
SK 16 RP 8	IFR5T-8N	
SK 16 RP 11	BKR5EIX-11P	
SK 20 BGR 11	HB6AIX-11P	
SK 20 BR 11	HB6BIX-11P	
SK 20 HPR-L11	ILFR6J-11K	
SK 20 HR 11	ILFR6T11	
SK 20 PR-A8	IFR6S	
SK 20 PR-A11	IFR6E11	
SK 20 PR-L9	IFR6C	
SK 20 R 11	IFR6T11	
SK 20 R 8 G	LPG1	
SK 20 RP 11	BKR6EIX-11P	
SK 22 PRM 11	IFR7G-11KS	
SK 22 PRM 11S	IFR7G-11KS	
SKJ 16 DRM 11	IZFR5K11	
SKJ 20 DR-M11	IZFR6K11	
SKJ 20 DR-M11S	IZFR6K11NS	
SKJ 20 DR-M13	IZFR6K13	
SVK 20 RZ 11	IFR6J11	
SVK 20 RZ 8	BKR6EP-8	
SXU 22 HCR 11 S	ILZKR7B11GS	
SXU 22 HDR 8	ILKR7B8	
SXU 22 PR 9	IKR7C	
T 14 PRU	BPR4FS	
T 14 PRU 15	BPR4FS-15	
T 16 EPRU	BPR5EFS	
T 16 EXU	BP5EFS	

DENSO	→ NGK	V-Line
T 16 PRU	BPR5FS	
T 16 PRU 11	BPR5FS-11	
T 16 PRU 15	BPR5FS-15	
T 16 PU	BP5FS	
T 16 RU	BR5FS	
T 16 RU 15	BR5FS	
T 16 U 15	YR55IX	
T 20 EPRU	BPR6EFS	7
T 20 EPRU 15	BPR6EFS-15	
T 20 EPU	BP6EFS	5
T 20 EPU 15	BPR6EFS-15	
T 20 EXU	BP6EFS	5
T 20 MPU	BPM6F	
T 20 MU	BM6F	
T 20 PRU	BPR6FS	
T 20 PRU 15	BPR6FS	
T 20 PU	BP6FS	
T 20 RU	BR6FS	
T 20 RU 15	BR6FS	
T 22 EPU	BP7EFS	
T 22 MPU	BPM7F	
T 22 MU	BM7F	
TR 20	B6HS	
TR 22	B7HS	
TR 24	B8HS	
TR 2210	B7HS-10	
TR 2410	B8HS-10	
U 14 FSRUB	CR4HSB	
U 14 FSUB	C4HSB	
U 16 FER-9	CR5EH-9	
U 16 FSL	C5HSA	
U 16 FSRL	CR5HSA	
U 16 FSRU	CR5HSA	
U 16 FSRUB	CR5HSB	
U 16 FSU	C5HSA	
U 16 FSUB	C5HSB	
U 17 F	C5HSA	
U 20 EPR-9	CPR6EA-9	
U 20 ESR-N	CR6E	
U 20 FS	C6HSA	
U 20 FSL	C6HSA	
U 20 FSRL	CR6HS	
U 20 FSRU	CR6HSA	
U 20 FSU	C6HSA	
U 20 MU	CM-6	
U 21 FB	C6HSA	
U 22 EPRU	CPR7EA-9	
U 22 ESN	C7E	
U 22 ESRN	CR7E	
U 22 ETR	CR7EK	
U 22 FER-9	CR7EH-9	
U 22 FS	C7HSA	



DENSO	→ NGK	V-Line
U 22 FSGU	CR7HIX	
U 22 FSL	C7HSA	
U 22 FSRL	CR7HS	
U 22 FSRU	CR7HSA	
U 22 FSU	C7HSA	
U 22 FSZU	CR7HIX	
U 24 ESN	C8E	
U 24 ESRN	CR8E	
U 24 ESRNB	CR8EB	
U 24 ESRNZU	CR8EIX	
U 24 ETR	CR8EK	
U 24 FB	C8HSA	
U 24 FE-9	C8EH-9	
U 24 FER-9	CR8EH-9	
U 24 FER-9S	CR8EH-9S	
U 24 FERZU-9	CR8EHIX-9	
U 24 FS	C8HSA	
U 24 FSL	C8HSA	
U 24 FSRC	LR8A	
U 24 FSRU	CR8HS	
U 24 FSRZU	CR8HIX	
U 24 FSU	C8HSA	
U 24 FSZU	CR8HIX	
U 27 ESN	C9E	
U 27 ESNZU	CR9EIX	
U 27 ESRN	CR9E	
U 27 ESRNB	CR9EB	
U 27 ESRNZU	CR9EIX	
U 27 ETR	CR9EK	
U 27 FE-9	C9EH-9	
U 27 FER-9	CR9EH-9	
U 27 FERZU-9	CR9EHIX-9	
U 27 FEZU-9	CR9EHIX-9	
U 31 ESRN	CR10E	
U 31 ETR	CR10EK	
VK 16	BKR5EIX-11P	
VK 16 J	ZFR5FIX-11P	
VK 16 PRZ 11	IFR5L11	
VK 20	IZFR6H11	
VK 20 PRZ 11	IFR6L11	
VK 20 T	LPG1	
VK 20 Y	BKR6EIX-P	
VK 22	IFR7F-6D	
VK 22 G	BKR7EIX-11PS	
VK 24 PRZ 11	IFR8H11	
VK 27 PRZ 11	IFR9H11	
VKA 20	HB6AIX-11P	
VKB 20	HB6BIX-11P	
VKH 16	ILZFR5B	
VKH 20	ILZFR6D11	
VKH 20 Y	LFR6AIX-P	
VKH 22	LFR7AIX-P	

DENSO	→ NGK	V-Line
VKJ 20 RZM 11	IZFR6F11	
VNH 27 Z	IMR9B-9H	
VQ 16	BCPR5EIX-11P	
VQ 20	BCPR6EIX-11P	
VUH 24 D	IMR8C-9H	
VUH 27 D	IMR9C-9H	
VUH 27 ES	IMR9C-9HES	
VUH 27 Z	IMR9A-9H	
VW 20 T	LPG2	
VX 22 BC	IJR7A9	
VX 22 BZ	IJR7A9	
VXU 22	DCPR7EIX-P	
W 9	B-2	
W 9 EP	BP-2E	
W 9 EPR	BPR2ES	
W 9 EXRU	BPR2ES	
W 9 EXU	BP-2E	
W 9 FP	BP-2H	
W 9 FPL	BP2HS	
W 9 FPLUL	BP2HS	
W 9 FPUL	BP2HS	
W 9 LMRUS	BR2-LM	
W 9 LMUS	B2-LM	
W 9 P	BP-4	
W 9 PRU	BP-4	
W 9 PU	BP-4	
W 9 U	B-2	
W 14	B-4	
W 14 E	B4ES	
W 14 EKRS 11	BUR4EB-11	
W 14 EP	BP4ES	
W 14 EPR	BPR4ES	
W 14 EPR 11	BPR4ES-11	
W 14 EPR-U	BPR4ES	
W 14 EP-U	BP4ES	
W 14 EXR-U	BPR4EY	
W 14 EXR-U 11	BPR4EY-11	
W 14 EXR-U 13	BPR4ES-13	
W 14 EXRZU	GR4IX	
W 14 EX-U	BP4EY	
W 14 EX-U 11	BP4EY-11	
W 14 EX-U 13	BPR4ES-13	
W 14 EXZU	GR4IX	
W 14 F	B-4H	
W 14 FP	BP-4H	
W 14 FPL	BP4HS	
W 14 FPLUL	BP4HA	
W 14 FPR	BPR-4H	
W 14 FPRL	BPR4HS	
W 14 FPR-U	BPR-4H	
W 14 FPR-UL	BPR4HS	
W 14 FPR-UL 10	BPR4HS-10	



DENSO	→ NGK	V-Line
W 14 FP-U	BP-4H	
W 14 FP-UL	BP4HS	
W 14 FP-UL 10	BP4HS-10	
W 14 FRL	BR4HSA	
W 14 FR-U	BR4HS	
W 14 F-U	B-4H	
W 14 F-U 10	B-4H-10	
W 14 L	B-4L	
W 14 LMR-US	BR4-LM	
W 14 LM-U	B4-LM	
W 14 LM-US	B4-LM	
W 14 MPR-U 10	BPMR4A	
W 14 MP-U 10	BPM4A-10	
W 14 MR-U	BMR4A	
W 14 M-U	BM4A	
W 14 M-US	BM4A	
W 14 P	BP5S	
W 14 P-U	BP-4	
W 14 PR-U	BP-4	
W 14 U	B-4	
W 14 U10	B-4	
W 14 US	B-4	
W 16 DTRS	BPR5EKB	
W 16 EKRS 11	BUR5EB-11	
W 16 EKS 11	BUR5EB-11	
W 16 EP	BP5ES	8
W 16 EP 11	BP5ES-11	
W 16 EPB	BP5EY	
W 16 EPB 10	BP5ET-10	
W 16 EPGU	BPR5EIX	
W 16 EPR	BPR5ES	6
W 16 EPR 11	BPR5ES-11	
W 16 EPRS 11	BUR5EA-11	
W 16 EPRU	BPR5ES	6
W 16 EPRU 10	BPR5E-11	
W 16 EPRU 11	BPR5ES-11	
W 16 EPU	BP5ES	8
W 16 EPU 10	BP5ES-11	
W 16 EPU 11	BP5EY-11	
W 16 EPZU	BPR5EIX	
W 16 ES	B5ES	
W 16 ESL 11	BR5ES	
W 16 ESRL	BR5ES	
W 16 ESRL 11	BUR5EB-11	
W 16 ESRU	BR5ES	
W 16 ESU	B5ES	
W 16 ETL	BPR5EY	9
W 16 ETRS	BPR5EIX-11	
W 16 ETS	BP5EK-A	
W 16 EX	BP5EY	
W 16 EXRU	BPR5EY	9
W 16 EXRU 11	BPR5EY-11	

DENSO	→ NGK	V-Line
W 16 EXRU 13	BPR5ES-13	
W 16 EXRZU	BPR5EIX	
W 16 EXU	BP5EY	
W 16 EXU 11	BP5EY-11	
W 16 EXU 13	BP5ES-13	
W 16 EXZU	BPR5EIX	
W 16 FP	BP5HS	
W 16 FPL	BP5HA	
W 16 FPR	BPR5HS	
W 16 FPRU	BPR5HS	
W 16 FPU	BP5HS	
W 16 FPU 10	BP5HS-10	
W 16 FPUL	BP5HA	
W 16 FS	B5HS	
W 16 FSR	BR5HS	
W 16 FSU	B5HS	
W 16 LS	B-6L	
W 16 PRU	BP5S	
W 16 PU	BP5S	
W 17	B6S	
W 17 ES	BR6ES	
W 17 FP	BP6HS	18
W 17 P	BP6S	
W 17 PRU	BP6S	
W 17 PU	BP6S	
W 20 DTRSA	BPR6EKB-L	
W 20 EA	B6EM	
W 20 EAR	BR6EM	
W 20 EKRS 11	BUR6EB-11	
W 20 EKS 11	BUR6EB-11	
W 20 EP	B6ES	
W 20 EP 11	BP6ES-11	
W 20 EPB	BUR6ET	1
W 20 EPBRS	BUR6ET	1
W 20 EPGU	BPR6EIX	
W 20 EPR	BPR6ES	2
W 20 EPR 11	BPR6ES-11	13
W 20 EPRS 11	BUR6EA-11	
W 20 EPR-U	BPR6ES	2
W 20 EPRU 10	BPR6ES-11	13
W 20 EPRU 11	BPR6ES-11	13
W 20 EPRZU	BPR6EIX	
W 20 EPRZU 11	BPR6EIX-11	
W 20 EPS 11	BUR6EA-11	
W 20 EPU	BP6ES	4
W 20 EPU 10	BP6ES-11	
W 20 EPU 11	BP6ES-11	
W 20 EPZU	BPR6EIX	
W 20 ES	B6ES	
W 20 ESGU	B6EVX	
W 20 ESL	BR6ES	
W 20 ESL 11	BUR6EB-11	



DENSO	→ NGK	V-Line
W 20 ESR	BR6ES	
W 20 ESRL	BR6ES	
W 20 ESRL 11	BUR6EB-11	
W 20 ESRU	BR6ES	
W 20 ESU	B6ES	
W 20 ESU 11	B6ES-11	
W 20 ESZU	B6EVX	
W 20 ET	BPR6EK-A	
W 20 ETL	BPR6EKN	
W 20 ETR	BPR6EK-A	
W 20 ETRL	BPR6EKN	
W 20 ETRL 8	BPR6EKN	
W 20 ETRS	BPR6EK-A	
W 20 ETS	BPR6EK-A	
W 20 EXRU	BPR6EY	
W 20 EXRU 11	BPR6EY-11	10
W 20 EXRU 13	BPR6EIX-11	
W 20 EXRZU	BPR6EIX	
W 20 EXU	BP6EY	
W 20 EXU 11	BP6EY-11	
W 20 EXU 13	BP6ES-13	
W 20 EXZU	BPR6EIX	
W 20 FP	BP6HS	18
W 20 FPL	BP6HSA	
W 20 FPR	BPR6HS	3
W 20 FPRL	BPR6HSA	
W 20 FPRU	BPR6HS	3
W 20 FPRU 10	BPR6HS-10	
W 20 FPRUL 10	BPR6HS-10	
W 20 FPU	BP6HS	18
W 20 FPU 10	BP6HS-10	
W 20 FRL	BR6HSA	
W 20 FS	B6HS	
W 20 FSGU	BR6HIX	
W 20 FSR	BR6HS	
W 20 FSRU	BR6HS	
W 20 FS-U	B6HS	
W 20 FSU 10	B6HS-10	
W 20 FSZU	BR6HIX	
W 20 M	BM6A	
W 20 MPRU 10	BPMR6A-10	
W 20 MPU	BPM6A	
W 20 MPU 10	BPM6A-10	
W 20 MRU	BMR6A	
W 20 MU	BM6A	
W 20 MUS	BM6A	
W 20 PRU	BP6S	
W 20 PU	BP6S	
W 20 S	B6S	
W 20 SRU	BR6S	
W 20 SU	B6S	
W 21 ESL 11	BR6EB-L-11	

DENSO	→ NGK	V-Line
W 21 ESRL 11	BR6EB-L-11	
W 22	B7S	
W 22 EA	B7EM	
W 22 EAR	BR7EM	
W 22 EB	BR7ET	
W 22 EBR	BR7ET	
W 22 EDR	BR7EQ	
W 22 EDR 14	BR7EQ-14	
W 22 EKRS 11	BUR7EB-11	
W 22 EKS 11	BUR7EB-11	
W 22 EP	BP7ES	
W 22 EP 11	BP7ES-11	
W 22 EPB	BP7ET	
W 22 EPGU	BPR7EIX	
W 22 EPR	BPR7ES	19
W 22 EPR 11	BPR7ES-11	
W 22 EPRS 11	BUR7EA-11	
W 22 EPRU	BPR7ES	19
W 22 EPRU 11	BPR7ES-11	
W 22 EPRZU	BPR7EIX	
W 22 EPS 11	BUR7EA-11	
W 22 EPU	BP7ES	
W 22 EPU 11	BP7ES-11	
W 22 EPZU	BPR7EIX	
W 22 ES	B7ES	
W 22 ESGU	BR7EIX	
W 22 ESL	BR7ES	
W 22 ESL 11	BUR7EB-11	
W 22 ESR	BR7ES	
W 22 ESRL	BR7ES	
W 22 ESRL 11	BUR7EB-11	
W 22 ESRU	BR7ES	
W 22 ESU	B7ES	
W 22 ESU 11	B7ES-11	
W 22 ESZU	BR7EIX	
W 22 ETL	BPR7EKN	
W 22 ETRL	BPR7EKN	
W 22 ETRL 8	BPR7EKN	
W 22 EXRU	BPR7EIX	
W 22 EXRU 11	BPR7EY-11	
W 22 EXU	BP7EY	
W 22 FP	BP7HS	
W 22 FPR	BPR7HS	
W 22 FPRU	BPR7HS	
W 22 FPRZU	BPR7HIX	
W 22 FPU	BP7HS	
W 22 FPU 10	BP7HS-10	
W 22 FPUS	BP7HS	
W 22 FS	B7HS	
W 22 FSGU	BR7HIX	
W 22 FSR	BR7HS	
W 22 FSRU	BR7HS	



DENSO	→ NGK	V-Line
W 22 FSU	B7HS	
W 22 FSZU	BR7HIX	
W 22 M	BM7A	
W 22 MPRU	BPMR7A	
W 22 MPU	BPM7A	
W 22 MPUS	BPM7A	
W 22 MU	BM7A	
W 22 MUS	BM7A	
W 22 S	B7S	
W 22 SU	B7S	
W 24	B8S	
W 24 EMRC	BR8ECM	
W 24 EP	BP8ES	
W 24 EP 11	BP8ES	
W 24 EPR	BPR8ES	
W 24 EPRU	BPR8ES	
W 24 EPRZU	BPR8EIX	
W 24 EPU	BP8ES	
W 24 ES	B8ES	
W 24 ESGU	BR8EIX	
W 24 ESR	BR8ES	
W 24 ESRU	BR8ES	
W 24 ESRV	BR8EG	
W 24 ESRZU	BR8EIX	
W 24 ESU	B8ES	
W 24 ESU 11	B8ES	
W 24 ESV	B8EG	
W 24 ESZU	B8EGV	
W 24 FP	BP8HS	
W 24 FPL	BPR8HSA	
W 24 FPR	BPR8HS	
W 24 FPRL	BPR8HSA	
W 24 FPRU 10	BPR8HS-10	
W 24 FPU	BP8HS	
W 24 FRL	BR8HSA	
W 24 FS	B8HS	
W 24 FSGU	BR8HIX	
W 24 FSR	BR8HS	
W 24 FSRU 10	BR8HS-10	
W 24 FSU	B8HS	
W 24 FSU 10	B8HS-10	
W 24 FSZU	BR8HIX	
W 24 S	B8S	
W 24 SU	B8S	
W 25 EA	BR8EM	
W 25 EAR	BR8EM	
W 25 EB	BR8ET	
W 25 EBR	BR8ET	
W 25 EDR	BR8EQ	
W 25 EDR 14	BR8EQ-14	
W 25 EN	B8EG	
W 25 EPT	B8EGP	

DENSO	→ NGK	V-Line
W 25 FC	B8HCS	
W 25 FN	BR8HIX	
W 27 EBR	BR9ET	
W 27 EDR	BR9EQ-14	
W 27 EDR 14	BR9EQ-14	
W 27 EMRC	BR9ECM	
W 27 EMRZU	BR9ECMIX	
W 27 EN	B9EG	
W 27 EPT	BR9EIX	
W 27 ES	B9ES	
W 27 ESC	B9ECS	
W 27 ESGU	BR9EIX	
W 27 ESR	BR9ES	
W 27 ESRU	BR9ES	
W 27 ESRV	BR9EG	
W 27 ESRZU	BR9EIX	
W 27 ESU	B9ES	
W 27 ESV	B9EG	
W 27 ESZU	B9EGV	
W 27 FC	B9HCS	
W 27 FN	BR9HIX	
W 27 FS	B9HS	
W 27 FSGU	BR9HIX	
W 27 FSR	BR9HS	
W 27 FSRU 10	BR9HS-10	
W 27 FSU	B9HS	
W 27 FSU 10	B9HS-10	
W 27 FSZU	BR9HIX	
W 29 EBR	BR10ET	
W 29 EPT	B95EGP	
W 29 ESGU	B95EGV	
W 29 ESRV	BR10EG	
W 29 ESV	B10EG	
W 29 ESZU	B95EGV	
W 31 EMRC	BR10ECM	
W 31 EMRZU	BR10ECMIX	
W 31 EN	B10EG	
W 31 EPT	B10EGP	
W 31 ES	B10ES	
W 31 ESGU	BR10EIX	
W 31 ESRU	BR10ES	
W 31 ESRZU	BR10EIX	
W 31 ESU	B10ES	
W 31 ESZU	B10EGV	
W 31 FS	B10HS	
W 31 FSGU	BR10HIX	
W 31 FSZU	BR10HIX	
W 32 EPT	B105EGP	
W 34 EN	B11EG	
W 34 ESZU	B11EGV	
WA 20 M	BM6F	
WA 20 MU	BM6F	





DENSO	→ NGK	V-Line
WA 22 M	BM7F	
WA 22 MU	BM7F	
X 16 EPRU 9	DPR5EA-9	
X 16 EPU 9	DPR5EA-9	
X 16 FSRU	DR5HS	
X 16 FSU	D5HS	
X 20 EPRU 9	DPR6EA-9	
X 20 EPU 9	DP6EA-9	
X 20 ESU	D6EA	
X 20 FSRU	DR6HS	
X 20 FSU	D6HA	
X 22 EPRGL	PJR7A	
X 22 EPRU 9	DPR7EA-9	
X 22 EPRZU 9	DPR7EIX-9	
X 22 EPU	DP7EA-9	
X 22 EPU 9	DP7EA-9	
X 22 EPZU 9	DPR7EIX-9	
X 22 ESGU	DR7EIX	
X 22 ESRU	DR7ES	
X 22 ESU	D7EA	
X 22 ESZU	DR7EIX	
X 22 GPRU	DPR7Z	
X 22 GPU	DPR7Z	
X 24 EPRU 9	DPR7EA-9	
X 24 EPRZU 9	DPR8EIX-9	
X 24 EPU	DP8EA-9	
X 24 EPU 9	DP8EA-9	
X 24 EPZU 9	DPR8EIX-9	
X 24 ESGU	DR8EIX	
X 24 ESRU	DR8ES-L	
X 24 ESRZU	DR8EIX	
X 24 ESRZU 9	DR8EIX	
X 24 ESU	D8EA	
X 24 ESZU	DR8EIX	
X 24 ESZU 9	DR8EIX	
X 24 FSRU	DR8HS	
X 24 FSU	D8HA	
X 24 GPRU	DPR8Z	
X 24 GPU	DP8Z	
X 27 EPRU 9	DPR7EA-9	
X 27 EPRZU 9	DPR9EIX-9	
X 27 EPU 9	DP9EA-9	
X 27 EPZU 9	DPR9EIX-9	
X 27 ESRU	DR8ES	
X 27 ESRZU	DR9EIX	
X 27 ESRZU 9	DR9EIX	
X 27 ESU	D9EA	
X 27 ESZU	DR9EIX	
X 27 ESZU 9	DR9EIX	
X 27 ET	J9A	
X 27 ETR	JR9B	
X 27 GPRU	DPR9Z	

DENSO	→ NGK	V-Line
X 27 GPU	DP9Z	
X 29 ESZU	DR9EIX	
X 31 ESU	D10EA	
X 31 ETR	JR10B	
XE 20 HRU 9	LZKAR7A	
XU 20 EPRU	DCPR6E	
XU 20 EPU	DCP6E	
XU 22 EPP	DCPR7EIX	
XU 22 EPR	DCPR7E	
XU 22 EPRP	DCPR7EIX	
XU 22 EPRU	DCPR7E	
XU 22 EPRZU	DCPR7EIX	
XU 22 EPU	DCP7E	
XU 22 EPZU	DCPR7EIX	
XU 22 HDR 9	LKR7B-9	
XU 24 EPRP	DCPR8EIX	
XU 24 EPRU	DCPR8E	
XU 24 EPRZU	DCPR8EIX	
XU 24 EPU	DCPR8E	
XU 24 EPZU	DCPR8EIX	
XU 27 EPRU	DCPR9E	
XU 27 EPRZU	DCPR9EIX	
Y 24 FERC	ER8EH	
Y 27 FER	ER9EH	
Y 27 FERC	ER9EH	
Y 31 FERC	ER10EH	
Z 20 ESU	D6EA	
ZXU 20 PR 11	IKR6G11	
ZXU 22 PR 11	IKR6G11	
D 14	BKR6E-11	14
D 21	BKR5E-11	33
S 21	IFR6S	
S 48	ILKAR7B11	
S 49	DF7H-11B	
S 65	DFH6B-11A	
3004	BPR5EP-11	
3005	BCPR5EIX-11	
3006	BCPR5EY-11	
3009	BCPR6EY-11	
3011	BP4EY	
3013	BPR4EY	
3018	BP5ES	8
3025	B5ES	
3027	BP5EY	
3032	BPR5EY-11	
3034	B5HS	
3036	BP5S	
3043	BP6ES	4
3046	BUR6EA-11	
3049	BPR6ES-11	13
3051	B6ES	
3057	BR6ES	



DENSO	→ NGK	V-Line
3062	BP6EY	
3066	BPR6EY	
3067	BPR6EY-11	10
3068	BP6HS	18
3070	BPR6HS	3
3073	B6HS	
3074	BR6HIX	
3075	B6S	
3085	BP7ES	
3088	BPR7ES	19
3089	BPR7ES-11	
3093	B7ES	
3095	BR7EIX	
3098	BR7ES	
3103	BR8ET	
3107	BR9ET	
3110	BR5ES	
3111	SD11A	
3112	ZFR6A-11	
3113	BCPR6EP-N-8	
3114	PGR5A-11	
3115	PGR6A-11	
3117	BCPR6EP-11	
3119	BKR5EYA	
3120	BKR5EYA-11	39
3121	BKR6E-11	14
3122	BKR6EYA	
3123	BCPR5EP-8	
3125	BCP6ES	17
3127	BKR6EP-8	
3128	BKR6EP-11	
3129	BCPR5EY	
3130	BKR5E-11	33
3131	ZFR5J-11	
3132	ZFR5F-11	
3133	ZFR6J-11	
3134	BKR5EP-11	
3135	ZFR5E-11	
3139	BKR6EY-11	
3140	BCPR6EY	
3141	PFR6J-11	
3142	PFR6G-11	
3144	BKR6E-N-11	
3156	BCPR5EIX-11	
3157	BCPR6EIX-11	
3158	BCP7EVX	
3161	BKR5EIX-11	
3163	BKR6EIX-11	
3165	BKR7E	
3167	ZFR4F-11	
3168	PFR6B-11	
3169	ZFR6F-11	

DENSO	→ NGK	V-Line
3172	PFR6G-13	
3174	PFR5J-11	
3175	PZFR5F	
3179	DCPR7E	
3184	BCPR5EY-11	
3186	BCPR5EY-11	
3187	BCPR6EY-11	
3192	BKR7E-11	
3194	BKR5EKB-11	
3195	BKR6EKB-11	
3196	BKUR6EK	
3197	BKUR7EK	
3199	BP5EY-11	
3201	BPR5ES-11	
3210	BPR5EY	9
3213	BPR5ES-13	
3226	BKR6EP-13	
3231	BPR5EIX	
3235	BCRE527Y	
3239	BPR5EP-11	
3242	DCPR7EIX	
3244	BCPR6EIX-11	
3245	PFR6J	
3246	PZFR5F-11	
3247	PZFR6F-11	
3253	BKR6EKP-11	
3255	BCP7ES	
3256	ZGR5A	15
3262	BKR6EIX-11	
3264	PFR5B-11	
3273	PFR7B	
3275	PFR5G-11	
3277	BPR6EKN	
3281	BPR7EIX	
3285	BPR5EIX-11	
3289	BKR5EKP-11	
3290	BKR7EIX	
3291	BPR6EIX	
3293	BKR5EIX	
3297	IFR6T11	
3299	BKR7E-N-11	
3302	PGR7A	
3303	IFR5T-8N	
3304	BKR6EKC	26
3305	BKUR6EK-9	
3306	PGR6A	
3307	IFR6C	
3310	BR10ET	
3312	DCPR8E	
3313	DCPR9E	
3314	DCPR9EIX	
3323	BPR6EIX-11	



DENSO	→ NGK	V-Line
3333	BKR6E	28
3344	BPR6ES	2
3345	BPR5ES	6
3346	BCPR5E	32
3347	BCPR7ES	
3348	ZFR7F-11	
3349	BKR5E	35
3353	BKR5EIX-11P	
3354	IGR7A	
3372	IFR7G-11KS	
3373	BKR6EP-8	
3374	ZFR6K-11	
3377	IZFR6K11	
3378	ZFR6FIX-11	
3379	BCPR7ES-11	
3380	BKR6EKPA	
3381	LFR6C-11	
3398	BKR6EIX-11P	
3400	IFR5E11	
3403	IFR6S	
3412	IFR5E11	
3413	ZFR5F	
3418	IFR6E11	
3424	BKR6E	28
3427	LZKAR7A	
3432	IZFR6K11NS	
3434	IKR7C	
3437	FR5EI	
3439	DILKAR6A11	
3441	ILKR7B8	
3444	ILKAR7B11	
3449	IFR6J11	
4019	BP5HS	
4021	BP7HS	
4025	B7HS	
4026	BR7HIX	
4027	B7S	
4028	BP8ES	
4030	B8ES	
4032	B8EGV	
4048	B9EGV	
4057	B95EGV	
4093	DP8EA-9	
4097	DPR8EIX-9	
4136	BPR8ES	
4167	DR8EIX	
4172	DR9EIX	
4189	CR8EIX	
4201	CR7EK	
5008	APR5FS	
5012	AP6FS	
5013	APR6FS	

DENSO	→ NGK	V-Line
5022	BPR5EFS	
5027	BPR5FS-15	
5031	BP6EFS	5
5032	BPR6EFS	7
5035	BPR6FS	
5040	BP7EFS	
5060	BKUR6ET	27
5061	BKUR6ET-10	24
5062	BKUR7ET	
5063	BKR6EKUB	
5064	BP5ET-10	
5065	BUR6ET	1
5066	BP7ET	
5067	BUR6ET	1
5068	PTR5A-13	25
5069	BCP7ET	
5070	PTR5D-10	31
5077	PZTR5A-15	
5301	BCPR5EIX-11	
5302	BCPR6EIX-11	
5303	BKR5EIX-11	
5304	BKR6EIX-11	
5305	BPR5EIX-11	
5306	BPR6EIX-11	
5307	BPR7EIX	
5308	DCPR7EIX	
5310	IRIWAY7	
5311	IRIWAY8	
5312	IRIWAY9	
5313	IRITOP7	
5316	BR8EIX	
5317	BR9EIX	
5325	TR5IX	
5326	TR6IX	
5327	TR7IX	
5328	TR8IX	
5330	UR5IX	
5331	UR6IX	
5343	LFR5AIX-11	
5344	LFR6AIX-11	
5361	CR7EIX	
5362	CR8EIX	
5372	DR8EIX	
5376	DPR8EIX-9	
5378	BPR6HIX	
5379	BR7HIX	
5601	BCPR5EIX-11P	
5602	BCPR6EIX-11P	
5603	BKR5EIX-11P	
5604	IZFR6H11	
5608	DCPR7EIX-P	
5615	IFR6L11	



DENSO	→ NGK	V-Line
5616	IFR8H11	
5617	ILZFR5B	
5618	ILZFR6D11	
5619	LFR7AIX-P	
5620	BKR6EIX-P	
5623	HB6AIX-11P	
5625	HB6BIX-11P	
5630	IFR9H11	
5639	LFR6AIX-P	
6054	B6HS	
6076	LFR5A-11	

**DODGE => CHRYSLER**

EYQUEM	→ NGK	V-Line
30 AM	B-4L	
50 AM	B-6L	
50 M	B5HS	
70 M	B6HS	
75 LM	B6ES	
75 M	B6HS	
100 M	B8HS	
200	B-4H	
202 CT	B2-LM	
300 AM	B-4L	
400 J	BR5FS	
406	BP6HS	18
450 JS	BPR4FS-15	
450 L	B5ES	
480 CS	BP5S	
500 AM	B-6L	
500 C	B6S	
500 CJT	BM6F	
500 CM	B6S	
500 CS	BP5S	
500 CT	BM6A	
500 J	BR6FS	
500 JS	BPR4FS	
500 M	B5HS	
502 CT	B4-LM	
505 JS	BP5FS	
520 CS	BP5S	
550 CS	BP5S	
550 JS	BPR5FS	
550 LS	BP5ES	8
550 S	BP4HS	
580 LS	BP5ES	8
580 S	BP4HS	
600 CS	BP5S	
600 JS	BPR6FS	
600 L	B6ES	

EYQUEM	→ NGK	V-Line
600 LS	BP6ES	4
600 S	BP5HS	
700	B6HS	
700 CM	B6S	
700 CTS	BPM6A	
705 JS	BP7FS	
705 L	B6ES	
705 S	BP6HS	18
707 LS	BP6ES	4
750	BP6HS	18
750 L	B6ES	
750 LJS	BP6EFS	5
750 LS	BP6ES	4
753 LJS	BP6EFS	5
755	B6HS	
755 CJT	BM7F	
755 CM	B6S	
755 CT	BM7A	
755 L	B6ES	
755 LJS	BP6EFS	5
755 LS	BP6ES	4
755 M	B6HS	
755 S	BP6HS	18
775 SX	BP6HS	18
775 X	B6HS	
800 L	B6ES	
800 LJS	BP6EFS	5
800 LS	BP6ES	4
802 L	B6ES	
803 LJS	BP6EFS	5
805 L	B6ES	
805 LJS	BP7EFS	
805 LJSP	TR7IX	
805 LP	BR8EIX	
850	B7HS	
850 LS	BP7ES	
883 LJP	B8EFS	
1000	B8HS	
1000 CM	B7S	
1000 L	B8ES	
1000 M	B8HS	
1100	B9HS	
1100 L	B8ES	
1150 L	B9ES	
C 32	B5HS	
C 32 LS	BP5ES	8
C 32 S	BP5HS	
C 42 LJS 3	BP6EFS	5
C 42 S	BP6HS	18
C 52 LS	BP5ES	8
C 62	B7HS	
C 62 LJS	BP6EFS	5



EYQUEM	→ NGK	V-Line
C 62 LS	BP6ES	4
C 62 LS 3 X	BP5ET	
C 62 S	BP7HS	
C 72 LJS	BP7EFS	
C 72 LS	BP7ES	
C 72 LS 3 X	BUR6ET	1
C 82 LJS	BP7EFS	
C 82 LS	BP7ES	
C 82 LS 3 X	BP7ET	
C 92 LS	BP8ES	
D 775	D6HA	
D 800 L	D7EA	
D 900 L	D8EA	
D 1000	D8HA	
D 1000 L	D9EA	
D 1050 L	D9EA	
FC 42 LS	BCP5ES	16
FC 52 LS	BCP5ES	16
FC 58 LS	BCP6ES	17
FC 62 LS	BCP6ES	17
FC 62 LS 2	BCP6ES	17
FC 62 LS 3	BCP6ET	
FC 62 LS 3 X	BCP6ET	
FC 72 LS	BCP7ES	
FC 82 LS	BCPR7E	
FC 82 LS 1	BCP7ES	
FC 82 LS 2	BCP7ES	
FN 52 LS	BK5ESZ	
K 200 M	AB-6	
K 300 JS	AP5FS	
K 300 M	AB-6	
K 350 JS	AP5FS	
K 450 JS	AP5FS	
K 500 M	AB-6	
K 550 JS	AP6FS	
K 600 M	AB-6	
K 750 M	AB-7	
KC 62 JS	AP6FS	
R 850	BR7HS	
R 1000	BR8HS	
R 1000 L	BR8ES	
RC 32 LS 5	BPR4ES-11	
RC 42 S	BPR6HS	3
RC 52 LS	BPR5EY	9
RC 52 LS 5	BPR5EY-11	
RC 52 LZ 3 EX	BUR5ET	22
RC 52 LZE	ZGR5A	15
RC 58 LZ 3 EX	BUR6ET	1
RC 62 HJSDP	PTR5A-13	25
RC 62 LJS	BPR6EFS	7
RC 62 LS	BPR6ES	2
RC 62 LS 5	BPR6ES-11	13

EYQUEM	→ NGK	V-Line
RC 62 S	BPR7HS	
RC 82 LS	BPR7ES	19
RC 82 LS 5	BPR7EY-11	
RFC 42 LS	BKR5ES	35
RFC 42 LS 2 E	BKR5EK	23
RFC 42 LZ 2 E	BKR6EK	20
RFC 50 LZ 2 E	BKR5EK	23
RFC 52 LS	BKR5ES	35
RFC 52 LS 3	BKR6ETUC	
RFC 52 LS 5	BKR5ES-11	33
RFC 52 LSP	BKR6EK	20
RFC 52 LZ 3 EX	BKUR5ET	29
RFC 52 LZE	ZFR5F	
RFC 52 LZK	BKR5EZ	36
RFC 57 LS 3	BCPR6ET	
RFC 58 LS	BKR6ES	28
RFC 58 LS 2 E	BKR6EK	20
RFC 58 LS 3	BCPR6ET	
RFC 58 LS 5	BKR6ES-11	14
RFC 58 LSP	BKR6EZ	38
RFC 58 LZ	BKR6EY	
RFC 58 LZ 2	BKR6EKC	26
RFC 58 LZ 2 E	BKR6EK	20
RFC 58 LZ 3 EX	BKUR6ET	27
RFC 58 LZ 5	BKR6EY-11	
RFC 58 LZDP	PFR6G-9	
RFC 58 LZE 5	ZFR6F-11	
RFC 62 LS 3	BKR6ES-11	14
RFC 62 LS 3 X	BCPR6ET	
RFC 62 LS 5	BKR6ES-11	14
RFC 62 LZ 3 X	BKUR7ET	
RFC 82 LS	BCPR7ES	
RFC 82 LS 5	BCPR7ES-11	
RFCLZ 3 X	BKUR7ET	
RFN 52 HZ	LFR5B	
RFN 52 HZ 3 A	LFR5B	
RFN 58 HZ	LFR6B	
RFN 58 LZ	BKR6EK	20
T 850	C7HSA	
XKC 62 JS	APR6FS	
<b>FERRARI =&gt; FIAT Group</b>		
FIAT Group	→ NGK	V-Line
15 57 43	PKR9B	
16 83 25	PMR8A	
16 94 83	PMR7A	
19 26 37	PMR8B	
31 2A 20 00	ILKR9G8	
31 32 53 225	DCPR8E	
46 14 47 31	DCPR8E	
46 22 92 51	BP6ES	4







<b>FORD</b>	<b>→ NGK</b>	<b>V-Line</b>
51 00 429	ILZTR6A8G	
1M50-12405-CA	PLTR6A-10G	
1S7J-12405-DA	PTR6F-13	
1S7J-12405-EB	PTR6D-13G	
1S7J-18344-EB	PTR6D-13G	
3S4J-12405-AB	ITR6F13	
3S4J-18344-AB	ITR6F13	
4M5G-12405-XC	TR5B-13	
4M5G-12405-XE	TR5B-13	
5M5G-12405-AA	TR6AP-13	
5M5G-18344-AA	TR6AP-13	
6118-61240-5BB	ILTR5A-13G	
6M5J-12405-AA	PLFR6A	
6M8G-12405-BB	ILTR5A-13G	
95VW-12405-DA	BKR5EKUP	
9A6G-12405-AA	ILZTR6A8G	
9A6G-12405-BA	ILTR6H8G	
9S51-12405-AA	ZKR7A-10	
AYFS-092FE-C	PLTR6A-10G	
BM5G-12405-CA	ILZTR6A8G	
F43E-12405-EB	PTR5D-13	
XS4F-12405-DA	PTR5A-13	25
YM21-12405-AA	PZFR5D-11	34
YN2F-12405-A2A	TR5B-13	
YN2J-12405-AA	TR5B-13	
<b>GM</b>	<b>→ NGK</b>	<b>V-Line</b>
12 14 046	PFR6T-G	
12 14 060	PFR6D10G	
12 14 065	DILFR7B10G	
12 14 066	IFR7X7G	
12 14 528	ZFR6BP-G	
48 11 581	ILTR5D	
5 958 780	BCP5EVX	
9 399 866	PFR6H-10	
12 556 183	PTR5C-13	
12 561 466	PTR5C-13	
12 563 707	PZTR5A-15	
12 565 030	PTR4B-15	
12 568 387	ITR4A15	
12 571 535	PTR5C-13	
12 578 277	PZTR5A-15	
12 620 540	ILTR5D	
12 787 099	PFR6T-10G	
12 788 884	PLFR6C-10G	
24 504 873	PTR4B-15	
30 520 467	BCPR6ES-11	11
32 000 330	BCPR7ES-11	
55 182 623	FR5CP	
55 562 534	PFR6T-G	
55 564 215	BKR7ESC-11	

<b>GM</b>	<b>→ NGK</b>	<b>V-Line</b>
55 564 748	DILFR7B10G	
55 564 763	ZFR6BP-G	
55 565 219	ZFR6V-G	
55 571 391	PFR6D10G	
55 576 026	IFR7X7G	
92 141 875	BPR6EFS-15	
93 161 199	PFR6G-9	
<b>HONDA</b>	<b>→ NGK</b>	<b>V-Line</b>
1 633 098	R0409B-10	
30717002 / 0	DR9EA	
12260-RL6-G010	ILZKR7B11GS	
12290-P5M-A000	PZFR6F-11	
12290-P73-J001	PFR7G-11	
12290-PCX-0000	PFR7G-11S	
12290-PCX-9999-TA	PFR7G-11S	
12290-PCX-J000	PFR7G-11S	
12290-PFD-J000	IFR6C	
12290-PGE-A01	PZFR6F-11	
12290-PNA-0030	IZFR6K13	
12290-PND-A010-M1	IZFR6K11	
12290-PNE-0030	ZFR6K-11	
12290-PRB-A010-M1	IFR7G-11KS	
12290-R60-U010-M1	IZFR6K11NS	
12290-RB0-J01	DIFR6D13	
12290-RB0-J110-M1	DIFR6D13	
12290-RB0-JB11	DIFR6D13	
12290-RB1-0030	IZFR6K13	
12290-RB1-0031	IZFR6K13	
12290-RB0-J11	DIFR6D13	
12290-RL6-G01	ILZKR7B11GS	
12290-RL6-G010-M1	ILZKR7B11GS	
12290-RMX-0030	ILFR6J-11K	
12290-RMX-0130	ILFR6J-11K	
12290-RSH-0030	IFR6G-11K	
12290-RW0-003	DILFR6J11	
12290-RW0-003	DILFR6J11	
31901-NN2-0030	BR6ES	
31901-NX4-7020-M1	R7376-10	
31901-NX4-9010	R7376-10	
31908-KRN-A41	R0451B-8	
31908-KRN-A410-M1	R0451B-8	
31908-KTW-901	LMAR8A-9	
31908-KTW-9010-M1	LMAR8A-9	
31908-KTW-9011-M1	LMAR8A-9	
31908-MGC-003	LMAR8A-9S	
31908-MGC-0031	LMAR8A-9S	
31908-MGC-A0000	LMAR8A-9S	
31908-ZZ3-0030	LMAR6C-9	
31908-ZZ3-A0031	LMAR6C-9	
31909-MEN-A31	SILMAR9A9S	



HONDA	→ NGK	V-Line
31909-MEN-A310-M1	SILMAR9A9S	
31909-MGC-0031	LMAR8A-9S	
31910-MEE-R110-M1	R0409B-10	
31910-MEN-A31	SILMAR10A9S	
31911-HW1-671	IMR9D-9H	
31911-HW1-6710-M1	IMR9D-9H	
31911-KRN-731	R0409B-8	
31911-KRN-7310-M1	R0409B-8	
31911-KSK-731	BR9EG-N-8	
31911-KSK-7310-M1	BR9EG-N-8	
31911-MBT-F21	IJR8B9	
31911-MBT-F210-M1	IJR8B9	
31911-MBW-E11	IMR8C-9H	
31911-MBW-E111-M1	IMR8C-9H	
31911-MBW-E112-M1	IMR8C-9H	
31912-KRN-731	R0409B-9	
31912-MBW-E11	IMR9C-9H	
31912-MBW-E111-M1	IMR9C-9H	
31912-MBW-E112-M1	IMR9C-9H	
31912-MCW-0030	IMR9B-9H	
31912-MEE-0000	IMR9C-9H	
31912-MEL-0030	IMR9C-9HES	
31912-MEL-A	IMR9C-9HES	
31912-MFL-0030	IMR9E-9HES	
31912-MGH-641	IMR8E-9HES	
31915-ZOH-0030	CMR5H	
31915-ZOH-0031	CMR5H	
31916-KPH-901	CPR6EA-9	
31916-KPH-9010-M1	CPR6EA-9	
31916-KRM-841	CPR8EA-9	
31916-KRM-8410-M1	CPR8EA-9	
31916-KRM-8413-M1	CPR8EA-9	
31916-MEH-0030	SIMR8A9	
31916-ZOH-003	CMR6H	
31916-ZX2-003	ZFR6K-11E	
31916-ZY3-0030	IZFR6F11	
31916-ZY3-0032	IZFR6F11	
31916-ZY3-004	IZFR6F11	
31917-KPH-901	CPR7EA-9	
31918-MEB-671	IFR8H11	
31918-MEB-6710-M1	IFR8H11	
31918-MEB-672	IFR9H11	
31919-MEB-671	IFR9H11	
31919-MEB-6710-M1	IFR9H11	
31919-MEB-672	IFR8H11	
31919-ZX2-0030	ZFR6K-11E	
3191W-ZOM-5400	BPR4ES	
3191W-ZOM-5500	BPR5ES	6
3191W-ZOM-5600	BPR6ES	2
31921-MBW-E12	IMR8C-9H	
31922-MBW-E12	IMR9C-9H	
31922-MEL-003	IMR9C-9HES	

HONDA	→ NGK	V-Line
31922-MFL-003	IMR9E-9HES	
31922-MOW-004	IMR9B-9H	
31926-KRM-841	CPR9EA-9	
31940-NX5-7520-M1	R7282-105	
31940-NX5-9410	R7282-105	
31988-GEV-761	ER8EH-N	
31988-GEV-7611-M1	ER8EH-N	
31999-KW6-6500	B9ECS	
89819-99010	BPR5ES	6
89839-99010	BPR6ES	2
94701-00408	CR9EIA-9	
98049-58716	ER8EH	
98049-59716	ER9EH	
98049-59726	ER9EH	
98049-60716	ER10EH	
98052-56471	CM-6	
98056-54718	CR4HSA	
98056-54750	C4HSB	
98056-54757	CR4HSB	
98056-54770	C4HSB	
98056-54777	CR4HSB	
98056-55713	C5HSA	
98056-55718	CR5HSA	
98056-55726	CR5HSA	
98056-55750	C5HSB	
98056-55757	CR5HSB	
98056-55770	C5HSB	
98056-55777	CR5HSB	
98056-56713	C6HSA	
98056-56713-00	C6HSA	
98056-56713-01	C6HSA	
98056-56716	CR6HS	
98056-56717	C6HA	
98056-56717-00	CR6HSA	
98056-56718	CR6HSA	
98056-5671R-00	CR6HSA	
98056-56723	C6HSA	
98056-56726	CR6HSA	
98056-57713	C7HSA	
98056-57713-00	C7HSA	
98056-57713-0A	C7HSA	
98056-57716	CR7HS	
98056-57718	CR7HSA	
98056-5771R-00	CR7HSA	
98056-57726	CR7HSA	
98056-58713	C8HSA	
98056-58716	CR8HS	
98056-58717	C8HA	
98056-58718	CR8HSA	
98059-55916	CR5EH-9	
98059-56916	CR6EH-9	
98059-57817-00	CR7E	



HONDA	→ NGK	V-Line
98059-57910	CR7EH-9	
98059-57916	CR7EH-9	
98059-57916-00	CR7E	
98059-57926	CR7EH-9	
98059-58816	CR8E	
98059-58816-H0	CR8E	
98059-58817-00	CR8E	
98059-58910	C8EH-9	
98059-58916	CR8EH-9	
98059-58916-00	CR8E	
98059-5891F	CR8EHIX-9	
98059-58920	C8EH-9	
98059-58926	CR8EH-9	
98059-5892D	IMR8C-9H	
98059-589J6	CR8EH-9S	
98059-589K6	CR8EH-9S	
98059-59816	CR9E	
98059-59816-H0	CR9E	
98059-59910	C9EH-9	
98059-59916	CR9EH-9	
98059-5991F	CR9EHIX-9	
98059-5991U	IMR9A-9H	
98059-5992U	IMR9C-9H	
98059-599U	CR9EHI-9	
98059-60916	CR10EH-9	
98061-57611	DPR7Z	
98061-57616	DPR7Z	
98061-58611	DP8Z	
98061-58616	DPR8Z	
98061-59611	DP9Z	
98061-59616	DPR9Z	
98066-54710	DR4HS	
98066-54716	DR4HS	
98066-55710	D5HS	
98066-55716	DR5HS	
98066-55740	D5HS	
98066-56710	D6HA	
98066-56716	DR6HS	
98066-56717	D6HA	
98066-56726	DR6HS	
98066-58710	D8HA	
98066-58714	D8HA	
98066-58716	DR8HS	
98066-58717	D8HA	
98066-60710	D10HS	
98069-38716	DR8ES-L	
98069-38719	DR8ES-L	
98069-55911	DPR5EA-9	
98069-55916	DPR5EA-9	
98069-56717	D6EA	
98069-56911	DP6EA-9	
98069-56916	DPR6EA-9	

HONDA	→ NGK	V-Line
98069-5691U	IJR6A9	
98069-5697Q	DCPR6E	
98069-5697Q-HE	DCPR6EIX	
98069-57716	DR7ES	
98069-57717	D7EA	
98069-57717-00	D7EA	
98069-57717-02	D7EA	
98069-57719	DR7ES	
98069-5771P	DR7EA	
98069-5771P-00	DR7EA	
98069-5771R	DR8EA	
98069-57726	DR7EA	
98069-5777P	DR7EB	
98069-57911	DP7EA-9	
98069-57912	DPR7EIX-9	
98069-57916	DPR7EA-9	
98069-57916-00	DPR7EA-9	
98069-5791U	IJR7A9	
98069-57922	DPR7EIX-9	
98069-5792U	IJR7A9	
98069-5797Q	DCPR7E	
98069-58716	DR8ES	
98069-58717	D8EA	
98069-58717-01	D8EA	
98069-58719	DR8ES	
98069-5871P	DR8EA	
98069-5871P-00	DR8EA	
98069-58726	DR8EA	
98069-58911	DP8EA-9	
98069-58912	DPR8EIX-9	
98069-58916	DPR8EA-9	
98069-58916-03	DPR8EA-9	
98069-5891F	DPR8EIX-9	
98069-58922	DPR8EIX-9	
98069-58926	DPR7EA-9	
98069-59717	D9EA	
98069-59911	DP9EA-9	
98069-59912	DPR9EIX-9	
98069-59916	DPR9EA-9	
98069-5991F	DPR9EIX-9	
98069-59926	DPR7EA-9	
98069-60717	D10EA	
98073-52710	B-2	
98073-54710	B-4	
98073-54740	BM4A	
98073-54744	BMR4A	
98073-54750	BM4A	
98073-54754	BMR4A	
98073-54771	BPM4A	
98073-54776	BPMR4A	
98073-54941	BPM4A-10	
98073-54944	BPMR4A-10	



HONDA	→ NGK	V-Line
98073-54951	BPM4A-10	
98073-56740	BM6A	
98073-56741	BPM6A	
98073-56744	BMR6A	
98073-56750	BM6A	
98073-56941	BPM6A-10	
98073-56944	BPMR6A-10	
98076-52711	BP2HS	
98076-52716	BPR2HS	
98076-52717	BPR2HS	
98076-52719	BP2HS	
98076-54710	B-4H	
98076-54711	BP4HS	
98076-54713	BP4HSA	
98076-54715	BPR4HSA	
98076-54716	BR4HS	
98076-54716-00	BR4HS	
98076-54717	BPR4HS	
98076-54719	BP4HS	
98076-5471G	BR4HSA	
98076-54720	BR4HS	
98076-54746	BR4HS	
98076-54747	BPR4HS	
98076-54770	B-4H	
98076-54780	B-4H	
98076-54821-CDI	BR4HS	
98076-54911	BP4HS-10	
98076-54911-CDI	BR4HS	
98076-54914	BPR4HS-10	
98076-54917	BPR4HS-10	
98076-54919	BP4HS-10	
98076-54921	BP4HS-10	
98076-54921-CDI	BR4HS	
98076-54944	BPR4HS-10	
98076-54947	BPR4HS-10	
98076-55711	BP5HS	
98076-55716	BR5HS	
98076-55717	BPR5HS	
98076-55719	BP5HS	
98076-55747	BPR5HS	
98076-56710	B6HS	
98076-56711	B6HS	
98076-56711-00	BP6HSA	
98076-56713	BP6HSA	
98076-56715	BPR6HSA	
98076-56716	BR6HS	
98076-56717	BPR6HS	3
98076-56719	BP6HS	18
98076-56719-02	BP6HS	18
98076-5671G	BR6HSA	
98076-5671G-00	BR6HSA	
98076-5671M	B6HSA	

HONDA	→ NGK	V-Line
98076-56721	BP6HS	18
98076-56725	BPR6HSA	
98076-56729	BPR6HS	3
98076-5672G	BR6HSA	
98076-56740	B6HS	
98076-56741	B6HS	
98076-56747	BPR6HS	3
98076-56756	BPR6HS	3
98076-56917	BPR6HS-10	
98076-56927	BPR6HS-10	
98076-57710	B7HS	
98076-57711	BP7HS	
98076-57716	BR7HS	
98076-57717	BPR7HS	
98076-57719	BP7HS	
98076-57719-01	BP7HS	
98076-57740	B7HS	
98076-58710	B8HS	
98076-58711	BP8HS	
98076-58713	BPR8HSA	
98076-58715	BPR8HSA	
98076-58716	BR8HS	
98076-58717	BPR8HS	
98076-58719	BP8HS	
98076-5871G	BR8HSA	
98076-5871G-00	BR8HSA	
98076-5871G-01	BR8HSA	
98076-5872G	BR8HSA	
98076-58740	B8HS	
98076-58747	BPR8HS	
98076-59710	B9HS	
98076-59716	BR9HS	
98076-59740	B9HS	
98079-52876	BPR2ES	
98079-54148	BCPR4ES-11	
98079-5414G	ZFR4F-11	
98079-54173	BUR4EB-11	
98079-54817	BPR4ES	
98079-54841	BP4ES	
98079-54846	BPR4ES	
98079-55132	BPR5EY-11	
98079-55140	BCPR5EY-11	
98079-55141	BP5EY-11	
98079-55144	BP5ES-11	
98079-55145	BPR5ES-11	
98079-55146	BPR5EY-11	
98079-55147	BCPR5ES-11	
98079-55148	BCPR5E-11	
98079-55149	BCPR5EY-11	
98079-5514A	BCPR5EY-N-11	
98079-5514B	BCPR5E-11	
98079-5514E	BKR5E-11	33





HONDA	→ NGK	V-Line
98079-5514E-H0	BKR5E-11	33
98079-5514F	BCPR5EIX-11	
98079-5514G	ZFR5F-11	
98079-5514G-01	ZFR5F-11	
98079-5514H	PFR5G-11	
98079-5514J	BKR5E-N-11	
98079-5514N	PZFR5F-11	
98079-5514N-01	PZFR5F-11	
98079-5514P	ZFR5J-11	
98079-5514P-H0	ZFR5J-11	
98079-55155	BPR5E-11	
98079-55158	BCPR5E-11	
98079-5515E	BKR5E-11	33
98079-5515G	ZFR6F-11	
98079-5515H	PFR5G-11	
98079-5515J	BKR5E-N-11	
98079-5515N	PZFR5F-11	
98079-5515U	IFR5L11	
98079-55173	BUR5EB-11	
98079-55174	BUR5EB-11	
98079-55176	BUR5EB-11	
98079-55178	BUR5EB-11	
98079-5517S	PFR5L-11	
98079-5517U	IFR5L11	
98079-5517V	IFR5G-11K	
98079-55183	BUR5EB-11	
98079-55810	B5ES	
98079-55811	BP5ES	8
98079-55816	BR5ES	
98079-55817	BPR5ES	6
98079-55840	B5ES	
98079-55841	BP5ES	8
98079-55841-03	BP5ES	8
98079-55844	BPR5EIX	
98079-55846	BPR5ES	6
98079-55847	BR5ES	
98079-55848	BR5ES	
98079-55849	BR5ES	
98079-55855	BPR5E	6
98079-5585C	BKR5E	35
98079-5585V	ZGR5A	15
98079-55876	BPR5ES	6
98079-55876-H0	BPR5ES	6
98079-5587G	ZFR5F	
98079-5587V	ZGR5A	15
98079-55941	BP5EY	
98079-55946	BPR5EY	9
98079-55A4N	PZFR5F-13	
98079-55A5N	PZFR5F-13	
98079-56115	BPR6ES-11	13
98079-5611R-00	ZFR6F-11	
98079-56132	BPR6EY-11	10

HONDA	→ NGK	V-Line
98079-56140	BKR6E-11	14
98079-56144	BP6ES-11	
98079-56145	BPR6ES-11	13
98079-56146	BPR6EY-11	10
98079-56147	BCPR6ES-11	11
98079-56148	BCPR6E-11	11
98079-56149	BCPR6EY-11	
98079-5614A	BCPR6EY-N-11	
98079-5614B	BKR6E-11	14
98079-5614E	BKR6E-11	14
98079-5614F	BCPR6EIX-11	
98079-5614G	ZFR6F-11	
98079-5614G-01	ZFR6F-11	
98079-5614H	PFR6G-11	
98079-5614J	BKR6E-N-11	
98079-5614J-01	BKR6E-N-11	
98079-5614N	PZFR6F-11	
98079-5614P	ZFR6J-11	
98079-5614P-00	ZFR6J-11	
98079-56155	BPR6ES-11	13
98079-56158	BCPR6EY-11	
98079-5615E	BKR6E-11	14
98079-5615F	BCPR6EIX-11	
98079-5615G	ZFR6F-11	
98079-5615H	PFR6G-11	
98079-5615J	BKR6E-N-11	
98079-5615N	PZFR6F-11	
98079-5615U	IFR6L11	
98079-56173	BUR6EB-11	
98079-56174	BUR6EB-11	
98079-56175	BP6EY-11	
98079-56179	BUR6EB-11	
98079-5617S	PFR6L-11	
98079-5617T	PFR6N-11	
98079-5617U	IFR6L11	
98079-5617V	IFR6G-11K	
98079-56183	BUR6EB-11	
98079-56614	B6EVX	
98079-56810	B6ES	
98079-56811	BP6ES	4
98079-56817	BR6ES	
98079-56832	BPR6EY	
98079-56840	B6ES	
98079-56841	BP6ES	4
98079-56844	BPR6EIX	
98079-56846	BPR6ES	2
98079-56847	BR6ES	
98079-56849	BR6ES	
98079-56854	BP6ES	4
98079-56855	BPR6ES	2
98079-5685C	BKR6E	28
98079-56871-H0	BP6ES	4



HONDA	→ NGK	V-Line
98079-56874	B6EVX	
98079-56876-H0	BPR6ES	2
98079-56941	BP6EY	
98079-56946	BPR6EY	
98079-5695U	IFR6C	
98079-5697U	IFR6C	
98079-569BE	BKR6E-9S	
98079-569CE	BKR6E-9S	
98079-56A7H	PFR6G-13	
98079-56A7S	PFR6L-13	
98079-57144	BP7ES-11	
98079-57145	BPR7ES-11	
98079-57146	BPR7EY-11	
98079-57147	BCPR7ES-11	
98079-57148	BCPR7E-11	
98079-57149	BCPR7EY-11	
98079-5714A	BCPR7EY-N-11	
98079-5714B	BCPR7E-11	
98079-5714E	BKR7E-11	
98079-5714F	BKR7EIX-11	
98079-5714G	ZFR7F-11	
98079-5714H	PFR7G-11	
98079-5714J	BKR7E-N-11	
98079-5714P	ZFR7J-11	
98079-57155-01	BPR7ES-11	
98079-57158	BCPR7E-11	
98079-5715E	BKR7E-11	
98079-5715F	BKR7EIX-11	
98079-5715G	ZFR7F-11	
98079-5715H	PFR7G-11	
98079-5715J	BKR7E-N-11	
98079-5715V	IFR7G-11KS	
98079-57171	BPR7EY-11	
98079-57173	BUR7EB-11	
98079-57174	BUR7EB-11	
98079-57175	BR6EB-L-11	
98079-57176	BR6ES	
98079-57177	BUR7EB-11	
98079-57178	BUR7EB-11	
98079-57179	BPR7EY-11	
98079-5717V	IFR7G-11KS	
98079-57183	BUR7EB-11	
98079-571BH	PFR7G-11S	
98079-571BV	IFR7G-11KS	
98079-571CH	PFR7G-11S	
98079-571CV	IFR7G-11KS	
98079-57614	BR7EIX	
98079-57810	B7ES	
98079-57811	BP7ES	
98079-57811-01	BP7ES	
98079-57816	BR7ES	
98079-57840	B7ES	

HONDA	→ NGK	V-Line
98079-57841	BP7ES	
98079-57846	BPR7ES	19
98079-57847	BR7ES	
98079-57848	BR7ES	
98079-57849	BR7ES	
98079-57855	BPR7ES	19
98079-5785C	BKR7E	
98079-5785G	ZFR7F	
98079-57874	BR7EIX	
98079-57876	BR7ES	
98079-57877	BR7ES	
98079-5787G	ZFR7F	
98079-5787T	PFR7N-D	
98079-57941	BP7EY	
98079-57946	BPR7EIX	
98079-5814E	BKR8E-11	
98079-5815E	BKR8E-11	
98079-5815U	FR8BI-11	
98079-5817U	FR8BI-11	
98079-58644	BR8EIX	
98079-58646	BR8EIX	
98079-58648	B8EG	
98079-58649	BR8EG	
98079-58678	B8EG	
98079-58679	BR8EG	
98079-58810	B8ES	
98079-58810-01	B8ES	
98079-58812	B9ECS	
98079-58816	BR8ES	
98079-58819	BR8ECS	
98079-58840	B8ES	
98079-58841	BP8ES	
98079-58842	B8ECS	
98079-58845	BR8ECM	
98079-58846	BR8ES	
98079-58847	BPR8ES	
98079-58857	BR8ES	
98079-58870	B8ES	
98079-58872	B8ECS	
98079-58875	BR8ECM	
98079-58876	BR8ES	
98079-5915U	FR9BI-11	
98079-5917U	FR9BI-11	
98079-59644	BR9EIX	
98079-59646	BR9EIX	
98079-59648	B9EG	
98079-59649	BR9EG	
98079-59659	BR9EG	
98079-59678	B9EG	
98079-59679	BR9EG	
98079-59810	B9ES	
98079-59811	B9ES	



HONDA	→ NGK	V-Line
98079-59812	B9ECS	
98079-59816	BR9ES	
98079-59819	BR9ECS	
98079-59840	B9ES	
98079-59842	B9ECS	
98079-59845	BR9ECM	
98079-59847	BR9ES	
98079-59855	BR9ECM	
98079-59870	B9ES	
98079-59872	B9ECS	
98079-59875	BR9ECM	
98079-59876	BR9ES	
98079-60616	BR10EIX	
98079-60646	BR10EIX	
98079-60648	B10EG	
98079-60649	BR10EG	
98079-60676	BR10EIX	
98079-60678	B10EG	
98079-60679	BR10EG	
98079-60817	BR10ES	
98079-60819	BR10ECS	
98079-60842	B10ECS	
98079-60845	BR10ECM	
98079-60872	B10ECS	
98079-60875	BR10ECM	
9807B-5515W	IZFR5K11	
9807B-5517W	IZFR5K11	
9807B-5615P	ZFR6K-11	
9807B-5615W	IZFR6K11	
9807B-5617C-00	IZFR6K-11E	
9807B-5617P	ZFR6K-11	
9807B-5617P-00	ZFR6K-11	
9807B-5617W	IZFR6K11	
9807B-561BW	IZFR6K-11S	
9807B-56A5W	IZFR6K13	
9807B-56A7W	IZFR6K13	
98179-56841	BP6ES	4
98735-4776	BPMR4A	
H9851-5517J	ZFR5FIX-11	
H9851-5517K	BKR5EIX-11	
H9851-5517Q	BCPR5EIX-11	
H9851-5617J	ZFR6FIX-11	
H9851-5617K	BKR6EIX-11	
H9851-5617Q	BCPR6EIX-11	
H9851-5717K	BKR7EIX-11	
H9858-5617K	BKR6EIX-11	
H9859-5998H	IMR9A-9H	
H9861-5515J	ZFR5FIX-11	
H9861-5515K	BKR5EIX-11	
H9861-5615J	ZFR6FIX-11	
H9861-5615K	BKR6EIX-11	
H9861-5615Q	BCPR6EIX-11	

HONDA	→ NGK	V-Line
H9868-5615K	BKR6EIX-11	
H9869-5798B	IJR7A9	
H9879-5518J	ZFR5FIX-11P	
H9879-5518K	BKR5EIX-11P	
H9879-5518Q	BCPR5EIX-11P	
H9879-5618J	ZFR6FIX-11P	
H9879-5618K	BKR6EIX-11P	
H9879-5618Q	BCPR6EIX-11P	
H9879-5718K	BKR7EIX-P	
H9880-5518J	ZFR5FIX-11P	
H9880-5518K	BKR5EIX-11P	
H9880-5518Q	BCPR5EIX-11P	
H9880-5618J	ZFR6FIX-11P	
H9880-5618K	BKR6EIX-11P	
H9880-5618Q	BCPR6EIX-11P	
H9880-5718K	BKR7EIX-P	
H9881-5515K	BKR5EIX-11P	
H9881-5615J	ZFR6FIX-11P	
H9881-5615K	BKR6EIX-11P	
H9888-5618K	BKR6EIX-11P	

HYUNDAI / KIA	→ NGK	V-Line
00259-18110	BP6ES	4
09482-00538	IFR5G11	
OK01A-18110	BKR5E	35
OK01C-18110	BKR6E-11	14
OK2AA-18110	BKR6E	28
OK558-18110	PFR6N-11	
18811-08061	BPR6ES	2
18811-11051	BPR5ES-11	
18814-08061	BKR6ES	28
18814-08062	BKR6ES	28
18814-11051	BKR5E-11	33
18814-11051	BKR5ES-11	33
18814-11061	BKR6ES-11	14
18814-25000	IFR5E11	
18817-11051	PFR5N-11	
18822-08091	BP6ES-11	
18823-11091	BKR5ES-11	33
18827-09080	PLKR7A	
18829-11050	ZFR5F-11	
18840-11051	ILFR5B11	
18841-11051	LFR5A-11	
18842-08061	PLFR6A	
18843-10062	LKR6D-10E	
18854-10080	LZKR6B-10E	
18855-10060	LZKR6B-10E	
27410-23700	IFR5G11	

ISOLATOR	→ NGK	V-Line
6 B	BP6HS	18
7 A	B6HS	



ISOLATOR	→ NGK	V-Line
7 B	BP6HS	18
7 D	BP6ES	4
A 5 D	BP7EFS	
A 7 D	BP6EFS	5
FM 14145 / 2	BP5ES	8
FM 14175 / 2	BP6ES	4
FM 14200 / 2	BP6ES	4
FM 14225 / 2	BP7ES	
M 14145	B5HS	
M 14175	B6HS	
M 14175 / 2	B6ES	
M 14225	B7HS	
M 14240	B8HS	
M 14260	B9HS	
M 1495	B-4H	
M 18225	AB-7	
M 18240	AB-7	
PM 14225	BP7HS	
U 7 D	BCP6ES	17
U 8 D	BCP5ES	16
ZM 14-260	B8HS	

ISUZU	→ NGK	V-Line
5-81380-001-0	BPR5ES	6
5-81380-003-0	BPR5EIX	
5-81380-004-0	BPR6EIX	
5-81380-005-0	BP5ES	8
5-81380-006-0	BP6ES	4
5-81380-007-0	BP5EY	
5-81380-008-0	BP6EY	
5-81380-012-0	BP5EY	
5-81380-013-0	BP6EY	
5-86003-122-0	ZFR5F-11	
5-86003-124-0	ZFR6F-11	
5-86007-635-0	BKR5E-11	33
5-86007-636-0	ZFR5J-11	
5-86007-639-0	ZFR6J-11	
5-86007-642-0	ZFR7J-11	
5-86013-957-0	PZFR5F-13	
5-86103-379-0	BPR4ES-11	
5-86103-380-0	BPR5ES-11	
5-86103-381-0	BPR6ES-11	13
5-86103-382-0	BPR7ES-11	
5-86103-385-0	PFR5B-11	
5-86103-386-0	PFR6B-11	
5-86103-387-0	PFR7B-11	
5-86103-389-0	PGR5A-11	
5-86103-390-0	PGR6A-11	
5-86103-391-0	PGR7A-11	
5-86121-749-0	BKR5ES-11	33
5-86121-750-0	BKR6ES-11	14

ISUZU	→ NGK	V-Line
5-86123-951-0	BKR5E-11	33
5-86123-952-0	BKR6E-11	14
5-86123-953-0	BKR7E-11	
8-94120-560-0	BPR5ES-11	
8-94120-561-0	BPR5EY-11	
8-94120-562-0	BPR6EY-11	10
8-94160-627-0	BPR6EY	
8-94217-232-0	BPR6ES-11	13
8-94219-943-0	BPR6ES	2
8-94235-966-0	BP5ES-11	
8-94237-203-0	BP5EY-11	
8-94241-059-0	BP6ES-11	
8-94252-270-0	BP6EY-11	
8-94328-372-0	BKR6E-11	14
8-94328-373-0	BKR7E-11	
8-94328-374-0	BKR6E-11	14
8-94328-375-0	BKR7E-11	
8-97012-928-0	BKR6E	28
8-97012-930-0	BKR6E	28
8-97012-931-0	BKR7E	
8-97111-376-0	PFR5B-11	
8-97170-268-0	BKR5EIX-11	
9-82513-103-0	BP6ES	4
9-82513-105-0	B6ES	
9-82513-106-0	BP5ES	8
9-82513-107-0	B5ES	
9-82513-113-0	B7ES	

JAGUAR	→ NGK	V-Line
7R83-12405-AA	TR6AP-13E	
8W-12405-AAA	ILKAR7C10	
8W93-12405-ABB	ILKAR7C10	
AJ 84575	IFR5N10	
AJ 812146	ILKAR7C10	
C2A 1535	IFR5N10	
C2P 23089	ILKAR7C10	
C2S 46895	TR6AP-13E	
EAC 8554	BR7EFS	
EBC 004021	BR7EF	
EBC 4021	BR7EF	
LR 019 484	ILKAR7C10	
NCA 3850 DA / 2	BKR6EIX-11	
NCA 3850 FA / 2	BKR6EVXA-13	
NCA 3850 HA / 2	PFR6G-13E	

**KIA => HYUNDAI/KIA**

**LAMBORGHINI => VW Group**

**LANCIA => FIAT Group**



<b>LAND ROVER</b>	<b>→ NGK</b>	<b>V-Line</b>
4550 157	IFR5N10	
LR 005 483	ILFR6B	
LR 019 484	ILKAR7C10	
LR 032 080	ILKAR7C10	
<b>LEXUS =&gt; TOYOTA</b>		
<b>LODGE</b>		
<b>LODGE</b>	<b>→ NGK</b>	<b>V-Line</b>
2 BTNY	AP5FS	
2 H	B7HS	
2 H 12	D8HA	
2 HA	B6S	
2 HAN	B8S	
2 HL	B7ES	
2 HL 10	C7HSA	
2 HLD	BCP6ES	17
2 HLE	B7ES	
2 HLN	B7ES	
2 HLN Y	BP7ES	
2 HN	B7HS	
2 HNY	BP7HS	
2 HTNY	AP7FS	
2 HTY	BP6FS	
2 HV	AB-8	
2 XL	BP6ES	4
3 BTY	BP4FS	
3 HAN	B8S	
3 HLN	B8ES	
3 HLN Y	BP7ES	
3 HN	B8HS	
3 HNY	BP8ES	
4 HLN Y	BP8ES	
5 HLN Y	BP8ES	
15 HLN Y	BP6ES	4
25 HL	BPR7ES	19
25 HLD	BCP6ET	
25 HLN Y	BP7ES	
25 XL	BP6ES	4
BAN	B-4	
BANY	BP5S	
BBANY	BP-4	
BBL	AB-6	
BBNY	BP-4H	
BL 14	B4ES	
BLN	B4ES	
BLNY	BP5ES	8
BLTY	BPR5EFS	
BN	B-4H	
BNY	BP-4H	
BTNY	AP5FS	
BTY	BP5FS	
BV	AB-2	

<b>LODGE</b>	<b>→ NGK</b>	<b>V-Line</b>
C 14	B5HS	
CAN	B6S	
CANB	BPM6A	
CANC	BM6A	
CANY	BP6S	
CC 14	B6HS	
CL 10	C6HSA	
CL 14	B5ES	
CLN	B6ES	
CLN 14 P	B5ES	
CLNH	B5ES	
CLNY	BP5ES	8
CN	B5HS	
CNY	BP5HS	
CSN	B-4L	
CTNY	AP5FS	
CTY	BP5FS	
CV	AB-6	
H	B6HS	
H 12	D6HA	
H 14	B7HS	
H 18	AB-7	
HA	B7S	
HAM	B7S	
HAN	B7S	
HB 12	D6HA	
HBAN	B6S	
HBL 12	D8EA	
HBLN	B5ES	
HBN	B5HS	
HBSN	B-6L	
HBTNY	AP6FS	
HBTY	BP5FS	
HBV	AB-6	
HF 2 HL	B8ES	
HH 14	B9HS	
HL	B6ES	
HL 12	D9EA	
HL 14	B6ES	
HLE	B6ES	
HLN	B6ES	
HLNP	B6ES	
HLNY	BP6ES	4
HN	B6HS	
HN 14	B7HS	
HNY	BP6HS	18
HT 14	BP5FS	
HT 18	AP6FS	
HTN	A6FS	
HTN 18	A7FS	
HTNY	AP6FS	
HTY	BP6FS	





<b>LODGE</b>	<b>→ NGK</b>	<b>V-Line</b>
HV	AB-7	
<b>LOTUS</b>		
	<b>→ NGK</b>	<b>V-Line</b>
A 100 E 6277 S	BKR6E	28
A 910 E 7009 F	BPR6EKN	
<b>MARCHAL / VALEO</b>		
	<b>→ NGK</b>	<b>V-Line</b>
11 720	B8HS	
12 086	B8HS	
17 C	AB-7	
19 C	AB-7	
19 E	AB-7	
19 L	AB-7	
2 / 32 H	B8ES	
2 / 33 H	B7ES	
20 C	AB-6	
20 E	AB-6	
20 L	AB-6	
21 C	AB-6	
21 E	AB-6	
21 L	AB-6	
22 L	AB-2	
22 LM	AB-2	
23 F	A6FS	
32 LM	AB-2	
34 / 5 HS	BP6ES	4
34 C	B7S	
34 CM	B7S	
34 HS	B7ES	
34 HSM	B7ES	
34 S	B7HS	
35	B6HS	
35 / 1	BP6HS	18
35 / 1 B	BP6HS	18
35 / 1 D	BP6HS	18
35 / 36 D	B6HS	
35 / 36 P	B6HS	
35 / 36 R	B6HS	
35 B	B6HS	
35 C	B6S	
35 CM	B6S	
35 HA	BP6ES	4
35 HS	B6ES	
35 M	B6HS	
35 P	B6HS	
36	B5HS	
36 B	B5HS	
36 C	B-4	
36 CM	B-4	
36 D	B5HS	
36 HS	B5ES	

<b>MARCHAL / VALEO</b>	<b>→ NGK</b>	<b>V-Line</b>
36 M	B5HS	
36 P	B5HS	
37 S	B5HS	
41 306	AB-8	
4 N	B7HS	
5 H	B7ES	
5 N	BP6HS	18
5 NCYCLO	BP6HS	18
64 H	BP7ES	
67 HP	BR8EIX	
6 H	BP7ES	
6 N	BP5HS	
70 H	BP6ES	4
76 H	BP5ES	8
7 H	BP6ES	4
84 H	BP5ES	8
88 N	B5HS	
8 H	BP6ES	4
9 H	BP5ES	8
C 64 H	BP6EFS	5
C 68 H	BP6EFS	5
C 7 H	BP6EFS	5
F 70 H	BCP7ES	
F 74 H	BCP6ES	17
F 80 H	BCP7ES	
GT 34	BP7HS	
GT 34 / 2 H	BP6ES	4
GT 34 / 5	BP6HS	18
GT 34 / 5 D	BP6HS	18
GT 34 / 5 H	BP6ES	4
GT 34 / 5 HA	BP6ES	4
GT 34 / 5 HD	BP6ES	4
GT 34 D	BP7HS	
GT 34 H	BP7ES	
GT 34 HD	BP6ES	4
GT 35	BP5HS	
GT 35 D	BP5HS	
GT 35 H	BP5ES	8
GT 35 HD	BP5ES	8
H 32 RG	B9EG	
H 33 RG	B8EG	
H 34 F	B8ES	
HA 32 / 2	B8ES	
HA 32 RS	B9EG	
HF 34	B7ES	
HF 34 F	B8ES	
RR 31 HS	B10EG	
RR 32 HS	B9EGV	
RR 33 HSS	B8EGV	
SCGT 34 / 5H	BP6EFS	5
SCGT 35 H	BP6EFS	5
V 36 A	B5HS	



<b>MARCHAL / VALEO</b>	<b>→ NGK</b>	<b>V-Line</b>
V 6 NSOLEX	B5HS	
<b>MARELLI</b>	<b>→ NGK</b>	<b>V-Line</b>
061 830 072 304	BCPR7ES	
061 830 085 304	BPR7ES	19
061 830 086 304	BKR6E	28
061 830 175 304	BP7ES	
061 830 176 304	BP6HS	18
061 830 210 304	BP6ES	4
061 830 211 304	BPR6ES	2
061 830 215 304	BP6EFS	5
061 830 254 304	BKR6E	28
061 830 257 304	BPR6HS	3
061 830 258 304	BP5HS	
061 830 262 304	BPR6EFS	7
061 850 023 304	PTR5A-13	25
062 000 611 304	B6HS	
062 000 654 304	BP6HS	18
062 000 739 304	BP6ES	4
062 000 740 304	BPR6ES	2
062 000 754 304	BP6HS	18
7 LCR	BKR6E	28
7 LPR	BKR6E	28
8 LCR	BCPR7ES	
8 LDCR	PTR5A-13	25
8 LPR	BCPR7ES	
AW 5 C	BM6A	
AW 56 C	BM7A	
CM 1 N	AB-2	
CM 2 N	AB-2	
CM 3 N	AB-6	
CM 4 N	AB-6	
CM 5 N	AB-6	
CM 6 N	AB-7	
CU 7 N	C7HSA	
CW 2 C	B-2	
CW 2 CJ	B-2	
CW 2 L	B4ES	
CW 2 N	B-4H	
CW 3 C	B-4	
CW 3 CJ	B-4	
CW 3 CP	BP-4	
CW 3 L	B4ES	
CW 3 N	B-4H	
CW 4 A	B5ES	
CW 4 C	B-4	
CW 4 CJ	B-4	
CW 4 CP	BP-4	
CW 4 L	B4ES	
CW 4 LP	BP4ES	
CW 4 N	B-4H	

<b>MARELLI</b>	<b>→ NGK</b>	<b>V-Line</b>
CW 4 NJ	B-4H	
CW 5 C	B-4	
CW 5 CP	BP5S	
CW 5 L	B5ES	
CW 5 LJ	B5ES	
CW 5 LP	BP5ES	8
CW 5 LS	B5ES	
CW 5 LSZ	B5ES	
CW 5 N	B5HS	
CW 5 NJ	B5HS	
CW 5 NP	BP5HS	
CW 5 NR	BR5HS	
CW 5 NS	B5HS	
CW 5 NSZ	B5HS	
CW 6 C	B6S	
CW 6 CE	BM6A	
CW 6 CJ	B6S	
CW 6 L	B5ES	
CW 6 LJ	B5ES	
CW 6 LP	BP5ES	8
CW 6 LR	BR5ES	
CW 6 LS	B5ES	
CW 6 LSZ	B5ES	
CW 6 N	B6HS	
CW 6 NE	BM6A	
CW 6 NJ	B6HS	
CW 6 NP	BP6HS	18
CW 6 NPR	BPR6HS	3
CW 6 NR	BR6HS	
CW 7 C	B6S	
CW 7 L	B6ES	
CW 7 LCR	BKR6E	28
CW 7 LJ	B6ES	
CW 7 LP	BP6ES	4
CW 7 LPH	BP6ES	4
CW 7 LPR	BPR6ES	2
CW 7 LR	BR6ES	
CW 7 N	B6HS	
CW 7 NJ	B6HS	
CW 7 NP	BP6HS	18
CW 7 NPR	BPR6HS	3
CW 7 NR	BR6HS	
CW 8 CJ	B7S	
CW 8 L	B7ES	
CW 8 LCR	BCPR7ES	
CW 8 LJ	B7ES	
CW 8 LP	BP7ES	
CW 8 LPR	BPR7ES	19
CW 8 LPS	BP7ES	
CW 8 N	B7HS	
CW 8 NP	BP7HS	
CW 8 NR	BR7HS	



MARELLI	→ NGK	V-Line
CW 9 L	B8ES	
CW 9 LJ	B8ES	
CW 9 LP	BP8ES	
CW 9 N	B8HS	
CW 10 L	B8EG	
CW 11 L	B9EG	
CW 12 L	B9EG	
CW 12 NV	BUH	
CW 13 L	B10EG	
CW 14 L	B10EG	
CW 25 N	B-4H	
CW 55 N	B5HS	
CW 67 L	B6ES	
CW 67 LP	BP6ES	4
CW 67 N	BP6HS	18
CW 67 NJ	B6HS	
CW 67 NR	BR6HS	
CW 67 P	BP5ES	8
CW 75 LP	BP6ES	4
CW 78 L	B6ES	
CW 78 LP	BP6ES	4
CW 78 LPR	BPR6ES	2
CW 78 LPS	BP6ES	4
CW 89 LP	BP7ES	
CW 101 L	B85EGV	
CW 112 L	B9EG	
CW 225 A	B6HS	
CW 250 A	B7HS	
CW 260 N	B7HS	
CWC 6 NJ	B6HS	
CWC 7 NJ	B6HS	
CWC 9 NJ	B7HS	
CWC 12 NJ	B8HS	
CWC 67 NJ	B6HS	
CWF 11 L	BR8EIX	
CWP 5 N	BR6HIX	
CWP 6 N	BR6HIX	
CWP 7 L	B6EVX	
CWP 7 N	BR6HIX	
CWP 8 L	BR7EIX	
CWP 8 N	BR7HIX	
CWP 9 L	BR8EIX	
CWP 9 N	BR8HIX	
CWP 10 L	BR9EIX	
CWP 10 N	BR9HIX	
CWP 11 L	B10EGV	
CX 6 N	D6HA	
CX 8 L	D8EA	
CX 8 N	D8HA	
DW 4 CJR	BR6S	
F 6 NC	BP5HS	
F 6 NCR	BPR5HS	

MARELLI	→ NGK	V-Line
F 7 LC	BP6ES	4
F 7 LCR	BPR6ES	2
F 7 NC	BP6HS	18
F 7 NCR	BPR6HS	3
F 8 LC	BP7ES	
F 8 LCR	BPR7ES	19
FC 6 N	B5HS	
FC 7 N	B6HS	
FC 9 L	BP8ES	
SW 5 C	BM6F	
T 7 LC	BP6EFS	5
T 7 LCR	BPR6EFS	7
T 8 LC	BP7EFS	
TM 2 NP	AP5FS	
TM 4 NP	AP6FS	
TW 4 LP	BP5EFS	
TW 5 NP	BP5FS	
TW 6 NP	BP6FS	
TW 7 LP	BP6EFS	5
TW 7 LPR	BPR6EFS	7
TW 7 NP	BP6FS	
TW 78 LP	BP6EFS	5
TW 78 LPR	BPR6EFS	7
TW 78 NPR	BPR6FS	
<b>MASERATI =&gt; FIAT Group</b>		
<b>MAYBACH =&gt; MERCEDES</b>		
MAZDA	→ NGK	V-Line
0000-18-1690	BPR6ES	2
0000-18-3648	BR7ET	
0000-18-3649	BR8ET	
0000-18-8914	BPR5ES	6
0000-18-B601	BPR5ES-11	
0000-18-BP01	BKR5E-11	33
0000-18-BP03	BKR6E-11	14
0000-18-BP47	BKR5E	35
0000-18-F201	ZFR6A-11	
0000-18-F203	ZFR5A-11	
0000-18-F285	ZFR6F-11	
0000-18-F287	ZFR5F-11	
0000-18-JE41	BKR5EIX-11	
0000-18-KJ11	PZFR6F	
0000-18-KJ13	PZFR5F	
0000-18-L3Y1	ILTR6A-13G	
0000-18-L3Y2	ILTR5A-13G	
0000-18-L3Y3	ILTR6A-8G	
0000-18-N201	BR8EQ-14	
0000-18-N203	BR9EQ-14	
0000-18-N328	BUR8EQ	
0000-18-N329	BUR6EQ	



MAZDA	→ NGK	V-Line
0000-18-N342	BUR9EQ	
0000-18-N343	BUR7EQ	
0000-18-N3A1	BUR9EQP	
0000-18-N3A2	BUR7EQP	
0000-18-N3A3	BUR8EQP	
0000-18-N3A4	BUR6EQP	
0000-18-N3Y1	RE9B-T	
0000-18-N3Y2L	RE7C-L	
0000-18-N3Y8	RE7C-L	
0190-18-110	B6HS	
0222-18-110	BP6EY	
0243-18-110	C6HA	
0259-18-110	BP6ES	4
0370-18-110	BPR6EIX	
0371-18-110	BPR5EIX	
0376-18-110	BPR7EIX	
0418-18-110A	B7ES	
0419-18-110	B7ES	
0420-18-110	B8ES	
0512-18-110	B6ES	
0660-18-110	BP5ES	8
0745-18-110	BP7ES	
0801-18-600	BR6EM	
0802-18-600	BR7EM	
0803-18-600	BR8EM	
0865-18-600	B6EM	
0866-18-600	B7EM	
0867-18-600	BR8EM	
0868-18-600	B9EM	
1001-77-550	BP4EY	
1002-77-550	BP5EY	
1003-77-550	BP6EY	
1409-18-110	BP5ES-13	
1410-18-110	BP5ES-13	
1482-18-600A	BR8EQ	
1483-18-600	BR8EQ	
1534-18-110	BP5EY	
1690-18-110	BPR6ES	2
1A01-18-110	PGR5A	
1A02-18-110	KR7AI	
1A03-18-110	IKR7A	
1A04-18-110	DCPR6E	
1A06-18-110	DCPR8E	
1A08-18-110	ZGR5A	15
1A10-18-110	GR5AI-10	
1A50-18-110	BKR6E	28
1A53-18-110	BKR6E-11	14
1A61-18-110	DCPR7EIX	
1N00-18-110	BKR4E-11	
1N04-18-110	BKR5EY-11	
1N06-18-110	BKR6EY-11	
1N07-18-110	PFR4G-11	

MAZDA	→ NGK	V-Line
1N08-18-110	PFR5G-11	
1N09-18-110	PFR6G-11	
1N11-18-110	FR7AI-D	
1N15-18-110	LFR5A-11	
1N17-18-110	LFR6A-11	
1N19-18-110	LZKAR6AP-11	
1N21-18-110	LFR4AP-11	
1N22-18-110	LFR5AP-11	
1UD0-18-110	BPR5EIX-11	
1UD1-18-110	BPR6EIX-11	
1UD2-18-110	BPR7EIX	
1UD3-18-110	BKR5EIX-11	
1UD4-18-110	BKR6EIX-11	
1UD6-18-110	BCPR5EIX-11	
1UD7-18-110	BCPR6EIX-11	
1UD9-18-110	DCPR7EIX	
1UN0-18-110	BPR5EIX	
1UN1-18-110	BPR6EIX	
1UN2-18-110	BPR7EIX	
1UN3-18-110	BPR5EIX-11	
1UN4-18-110	BPR6EIX-11	
1UN6-18-110	BKR5EIX	
1UN7-18-110	BKR6EIX	
1UN9-18-110	BKR5EIX-11	
1UNA-18-110	BKR6EIX-11	
1UNC-18-110	BCPR5EIX-11	
1UND-18-110	BCPR6EIX-11	
1UNF-18-110	DCPR7EIX	
1UNG-18-110	ZFR5FIX-11	
1UNH-18-110	ZFR6FIX-11	
1UT3-18-110	BKR5EIX-11P	
1UT4-18-110	BKR6EIX-11P	
1UT6-18-110	BCPR5EIX-11P	
1UT7-18-110	BCPR6EIX-11P	
1UT9-18-110	DCPR7EIX-P	
1UX6-18-110	BKR5EIX-P	
1UX7-18-110	BKR6EIX-P	
1UX9-18-110	BKR5EIX-11P	
1UXA-18-110	BKR6EIX-11P	
1UXC-18-110	BCPR5EIX-11P	
1UXD-18-110	BCPR6EIX-11P	
1UXF-18-110	DCPR7EIX-P	
1UXG-18-110	ZFR5FIX-11P	
1UXH-18-110	ZFR6FIX-11P	
1UXJ-18-110	BPR5EFIX-13P	
1Y00-18-110	BPR5ES	6
1Y01-18-110	BPR6ES	2
1Y03-18-110	BPR5ES-11	
1Y06-18-110	BKR5E	35
1Y07-18-110	BKR6E	28
1Y09-18-110	BKR5E-11	33
1Y0A-18-110	BKR6E-11	14



MAZDA	→ NGK	V-Line
1Y0B-18-110	BKR7E-11	
1Y0F-18-110	DCPR7E	
1Y0G-18-110	ZFR5F-11	
1Y0H-18-110	ZFR6F-11	
1Y0K-18-110	BPR5ES-13	
1Y0L-18-110	BRE527Y-11	
1YR7-18-110	BKR6EIX-P	
1YR9-18-110	BKR5EIX-11P	
1YRA-18-110	BKR6EIX-11P	
1YRF-18-110	DCPR7EIX-P	
1YRG-18-110	ZFR5FIX-11P	
1YRH-18-110	ZFR6FIX-11P	
2182-18-600	BR7EM	
2183-18-600	BR8EM	
2328-18-600	B7EM	
2359-18-600	BR8EM	
242-18-110	C6HSA	
3648-18-600	BR7ET	
3649-18-600	BR8ET	
3710-18-110	BP6ES-13	
3743-18-600	BR7ET	
3744-18-600	BR8ET	
3953-18-110	BPR5EY	9
3954-18-110	BPR6EY	
4075-18-110	BP4ES	
4095-18-110	BP4EY	
4096-18-110A	BPR4ES-13	
418-18-110	B7ES	
4882-18-110	BP-2E	
4884-18-110	BPR2ES	
4885-18-110	BPR2ES	
4894-18-110	BP-2E	
6M8G-12-405BB	ILTR5A-13G	
8042-18-110	BPR6EIX-11	
8182-18-600	BR7EQ	
8248-18-600	BR8ET	
8344-18-600	BR9ET	
8526-18-600	B6EM	
8865-18-600	B6EM	
8914-18-110	BPR5ES	6
A501-18-110	BP6E	4
A502-18-110	BP6ES	4
AY02-18-110	DCP7E	
AY01-18-110	DCP7E	
AZ08-18-110	BPR5E	6
AZ09-18-110	BPR5E	6
AZ28-18-110	DCPR7EIX	
AZ29-18-110	DCPR7EIX	
B601-18-110	BPR5ES-11	
B602-18-110	BPR5EY-11	
B64N-18-110	BRE527Y-11	
B64P-18-110	BRE527Y-11	

MAZDA	→ NGK	V-Line
B660-18-110	BKR6E-11	14
B667-18-110	BKR6E-11	14
B672-18-110	BPR5ES	6
B695-18-110	BCPR6E	12
B696-18-110	BCPR6E	12
B6B3-18-110	BCPR5E-11	
B6B4-18-110	BCPR5E-11	
BBYV-18-110	R7436-10	
BBYV-18-11Z	R7436-9	
BP01-18-110	BKR5E-11	33
BP02-18-110	BKR5E-11	33
BP03-18-110	BKR6E-11	14
BP04-18-110	BKR6E-11	14
BP05-18-110	BKR7E-11	
BP06-18-110	BKR7E-11	
BP07-18-110	BKR6ES-11	14
BP09-18-110	BKR6ES-11	14
BP47-18-110	BKR5E	35
BP47-18-110P00	BKR5E	35
BP48-18-110	BKR5E	35
BP49-18-110	BKR6E	28
BP50-18-110	BKR6E	28
BP51-18-110	BKR7E	
BPY1-18-110	BKR5E-11	33
BPY3-18-110	BKR6E-11	14
E356-18-110	BE527Y-11	
E357-18-110	BE527Y-11	
F201-18-110	ZFR6A-11	
F202-18-110A	ZFR6A-11	
F203-18-110	ZFR5A-11	
F204-18-110	ZFR5A-11	
F205-18-110	ZFR7F-11	
F210-18-110	BCPR5E	32
F211-18-110	BCPR5E	32
F220-18-110	BCPR6E-11	11
F221-18-110	BCPR6EY-11	
F261-18-110	ZFR6F-11	
F285-18-110	ZFR6F-11	
F286-18-110	ZFR6J-11	
F287-18-110	ZFR5F-11	
F288-18-110	ZFR5J-11	
F289-18-110	ZFR7F-11	
F293-18-110	ZFR5F-11	
F2C5-18-110	ZFR6F-11	
F2C7-18-110	ZFR6F-11	
F806-18-110	BPR4ES-13	
F8B1-18-110	ZFR6A-11	
F8B2-18-110A	ZFR6A-11	
F8B3-18-110	ZFR5F-11	
F8B5-18-110	ZFR7F-11	
F8B7-18-110	ZFR4F-11	
F8L6-18-110	ZFR4F-11	





MAZDA	→ NGK	V-Line
F8L7-18-110	ZFR4F-11	
F8L8-18-110	BPR4ES-13	
F8L9-18-110	BPR4ES-13	
FE3N-18-110	BCPR7E-11	
FE6E-18-110	BCPR7E-11	
FE6F-18-110	BCPR7E-11	
FE79-18-110	BPR6ES-11	13
FE82-18-110	BPR6EY-11	10
FEDK-18-110	BPR5ES-13	
FEDM-18-110	BPR5ES-13	
FEEG-18-110	BPR6ES-13	
FEEH-18-110	BPR6EIX-11	
FEFB-18-110	BPR6ES-11	13
JE03-18-110	BCPR7E	
JE26-18-110	BCPR5EIX-11	
JE27-18-110	BCPR6EIX-11	
JE28-18-110	BCPR5EIX-11	
JE41-18-110	BKR5EIX-11	
JE42-18-110	BKR5EIX-11	
JE43-18-110	BKR6EIX-11	
JE44-18-110	BKR6EIX-11	
JE45-18-110	BKR7EIX-11	
JE46-18-110	BKR7EIX-11	
JF03-18-110	BCPR5E-11	
JF04-18-110	BCPR5E-11	
KJ11-18-110	PZFR6F	
KJ12-18-110	PZFR6F	
KJ13-18-110	PZFR5F	
KJ14-18-110	PZFR5F	
L303-18-110	TR5AI-13	
L341-18-110	ITR6F13	
L3BD-18-110	SILTR6A7G	
L3G2-18-110	ILTR6A-13G	
L3K9-18-110	ILTR6A-8G	
L3K9-18-110A	ILTR6A-8G	
L3Y1-18-110	ILTR6A-13G	
L3Y2-18-110	ILTR5A-13G	
L3Y3-18-110	ILTR6A-8G	
L3Y4-18-110	ITR6F13	
L3YD-18-110	SILTR6A7G	
L813-18-110	ITR6F13	
L814-18-110	BPR6EF-13	
LFG1-18-110	ILTR5A-13G	
LFY1-18-110	TR5B-13	
LFY3-18-110	BPR5EFS-13	
N201-18-600	BR8EQ-14	
N202-18-600	BR8EQ-14	
N203-18-600	BR9EQ-14	
N212-18-600	BR7EQ-14	
N212-18-600A	BR7EQ-14	
N218-18-600	BR8EQ-14	
N225-18-600A	BUR9EQ	

MAZDA	→ NGK	V-Line
N236-18-600	BUR9EQ	
N238-18-600	BUR8EQ	
N245-18-600	SD10A	
N246-18-600	BR9EQ-14	
N253-18-600	BR9EQ-14	
N322-18-110	BR10ET	
N328-18-110	BUR8EQ	
N329-18-110	BUR6EQ	
N331-18-110	SD10A	
N333-18-110	SD11A	
N335-18-110	SD9A	
N338-18-110	SD11A	
N339-18-110	SD10A	
N340-18-110	BUR9EQ	
N341-18-110	BUR7EQ	
N342-18-110	BUR9EQ	
N343-18-110	BUR7EQ	
N390-18-110	BUR5EQ	
N3A1-18-110	BUR9EQP	
N3A2-18-110	BUR7EQP	
N3A3-18-110	BUR8EQP	
N3A4-18-110	BUR6EQP	
N3H1-18-110C	RE9B-T	
N3H1-18-110D	RE9B-T	
N3H2-18-110C	RE7C-L	
N3H5-18-110	RE7C-L	
N3H5-18-110A	RE7C-L	
N3H8-18-110A	RE9B-T	
N3H8-18-110B	RE9B-T	
N3H9-18-110A	RE8C-L	
N3J1-18-110	RE8C-L	
N3J1-18-110A	RE8C-L	
N3M1-18-1BXA	RE7C-L	
N3M1-18-1BXB	RE7C-L	
N3Y1-18-110	RE9B-T	
N3Y1-18-110A	RE9B-T	
N3Y1-18-110A9U	RE9B-T	
N3Y1-18-S30	RE7C-L	
N3Y1-18-S30	RE9B-T	
N3Y1-18-S30L	RE7C-L	
N3Y1-18-S30T	RE9B-T	
N3Y2-18-110	RE7C-L	
N3Y2-18-110L	RE7C-L	
N3Y2-18-S30	RE8C-L	
N3Y2-18-S30	RE9B-T	
N3Y2-18-S30L	RE8C-L	
N3Y2-18-S30T	RE9B-T	
N3Y3-18-S30	RE7C-L	
N3Y3-18-S30	RE9B-T	
N3Y4-18-110	RE9B-T	
N3Y4-18-110A	RE9B-T	
N3Y4-18-S30	RE8C-L	



<b>MAZDA</b>	<b>→ NGK</b>	<b>V-Line</b>
N3Y4-18-S30	RE9B-T	
N3Y5-18-110	RE8C-L	
N3Y5-18-110L	RE8C-L	
N3Y6-18-110	RE7C-L	
N3Y6-18-110L	RE7C-L	
N3Y8-18-110	RE7C-L	
N3Y8-18-110A	RE7C-L	
N3Y8-18-110A9U	RE7C-L	
N3Z1-18-110	RE8C-L	
N3Z1-18-110A	RE8C-L	
N3Z2-18-110	RE7C-L	
N3Z2-18-110A	RE7C-L	
N3Z4-18-110	RE7C-L	
N3Z5-18-110	RE8C-L	
N3ZZ2-18-110A	RE7C-L	
PBP01-18-110AA	BKR5E-11	33
TF50-18-110	BKR6EIX	
Z601-18-110	BKR5EIX-11P	
ZJY6-18-110	IFR5E13	
ZR03-18-110	R6725-115	
ZZS1-18-110	DCPR7E	
ZZS2-18-110	DCPR7E	
ZZS4-18-110	BPR5EY	9
ZZSI-18-110	DCPR7E	

<b>MERCEDES</b>	<b>→ NGK</b>	<b>V-Line</b>
0 003 085 V005	BKR6EKE	
0 012 468 V001	LKR8A	
0 012 468 V002	LKR8A	
A 002 159 18 03	BP7ES	
A 002 159 22 03	BP5ES	8
A 002 159 24 03	BP6ES	4
A 002 159 27 03	BP7ES	
A 002 159 28 03	BP6ES	4
A 002 159 29 03	BP5ES	8
A 002 159 31 03	BP5ES	8
A 002 159 41 03	BP6ES	4
A 002 159 42 03	BP6ES	4
A 002 159 48 03	BP5ES	8
A 002 159 49 03	BP6EFS	5
A 002 159 56 03	BP6EFS	5
A 002 159 57 03	BP5EFS	
A 002 159 58 03	BP5EFS	
A 002 159 64 03	BP7EFS	
A 002 159 65 03	BP7EFS	
A 002 159 68 03	BP6EFS	5
A 002 159 69 03	BP6EFS	5
A 002 159 76 03	BP5EFS	
A 002 159 77 03	BCP5ES	16
A 003 159 04 03	BP5EFS	
A 003 159 05 03	BP5EFS	
A 003 159 06 03	BP6EFS	5

<b>MERCEDES</b>	<b>→ NGK</b>	<b>V-Line</b>
A 003 159 07 03	BP6EFS	5
A 003 159 08 03	BP7EFS	
A 003 159 10 03	BP5ESZ	
A 003 159 11 03	BP5ESZ	
A 003 159 12 03	BP6ESZ	
A 003 159 13 03	BP6ESZ	
A 003 159 14 03	BP7ES	
A 003 159 16 03	BCP6ES	17
A 003 159 30 03	BCP5ES	16
A 003 159 31 03	BCP6ES	17
A 003 159 33 03	BP7EFS	
A 003 159 34 03	BP6EFS	5
A 003 159 35 03	BP6EFS	5
A 003 159 36 03	BP5EFS	
A 003 159 37 03	BCP5ES	16
A 003 159 40 03	BP5EFS	
A 003 159 41 03	BP5EFS	
A 003 159 42 03	BCP5ES	16
A 003 159 45 03	BP6ESZ	
A 003 159 46 03	BP5ESZ	
A 003 159 47 03	BP5ESZ	
A 003 159 56 03	BP7ES	
A 003 159 57 03	BP6ESZ	
A 003 159 75 03	BKUR5ET	29
A 003 159 76 03	BKUR5ET	29
A 003 159 78 03	BKR6ES	28
A 003 159 81 03	PFR5R-11	
A 003 159 90 03	BKUR5ET	29
A 003 159 91 03	BKR5EKUP	
A 003 159 92 03	BKR6EKE	
A 003 159 94 03	PFR5R-11	
A 003 159 96 03	IFR5D10	
A 003 159 96 03 26	IFR5D10	
A 003 159 97 03	IFR6D10	
A 003 159 97 03 26	IFR6D10	
A 004 159 13 03	ILFR6A	
A 004 159 14 03	IFR6Q-G	
A 004 159 15 03	LKR8A	
A 004 159 19 03	PFR5R-11	
A 004 159 25 03	SILZKR7A-S	
A 004 159 25 63	SILZKR7A-S	
A 004 159 30 03	BKR6EZB	
A 004 159 34 03	PLKR6A	
A 004 159 36 03	BKR6EZB	
A 004 159 39 03	ILZKAR7A10	
A 004 159 44 03	PLKR7B8E	
A 004 159 45 03	ILFR6A	
A 004 159 49 03	PLKR7A	
A 004 159 50 03	PFR5R-11	
A 004 159 58 03	PLKR7B8E	
A 122 159 00 03	ILZFR6C-K	
A 132 159 00 03	LKR7B-9	



MERCEDES	→ NGK	V-Line
A 376 159 72 03	T7204A	
MN 195 922	ILZFR6C-11K	
Q0 003 085 V005 00 000	BKR6EKE	
Q0 012 468 V001 00 0000	LKR8A	
Q0 012 468 V002 00 0000	LKR8A	
<b>MG =&gt; ROVER</b>		
<b>MINI =&gt; BMW</b>		
MITSUBISHI	→ NGK	V-Line
1822 A002	IFR6B-K	
1822 A005	ILZFR6C-K	
1822 A011	ILKR7B8	
1822 A021	ILKR8E6	
1822 A022	ILFR7H	
1822 A068	DIFR5C11	
1822 A069	DIFR6C11	
1822 A079	DILKR8B6	
1822 A085	DILFR5A11	
1822 A086	LZFR5BI-11	
801 001	B-4	
801 033	B7HS	
MD 313 442	PFR5G-11	
MD 313 443	PFR6G-11	
MD 314 766	BKR7EKC-N	
MD 319 517	PFR6G	
MD 320 543	BKR7EKC-N-11	
MD 320 572	BKR5E	35
MD 321 150	BKR6EKC-N-11	
MD 322 771	PFR6B-11	
MD 331 057	ZFR5F-11	
MD 336 367	IZFR6B	
MD 338 492	BPR4ES	
MD 338 991	PGR7A	
MD 342 386	PZFR5F-11	
MD 343 277	PGR6A	
MD 348 296	PZFR5B	
MD 351 467	PZFR5C	
MD 355 067	BKR6EKUC	
MD 357 531	PFR6J	
MD 358 200	ZFR6F-11	
MD 358 201	ZFR6F-11	
MD 358 202	ZFR6F-11	
MD 360 019	IZFR6B	
MD 360 383	IZFR5B	
MD 361 067	IFR5E11	
MD 362 097	ZFR5F-11	
MD 362 098	ZFR5F-11	
MD 362 902	BKR5EKUC	
MD 365 108	BPR5EKU	

MITSUBISHI	→ NGK	V-Line
MD 366 819	IZFR5C	
MD 371 434	IGR7A	
MD 371 435	IGR7A	
MD 372 421	BKR5EKUD	
MD 372 422	BKR6EKUD	
MD 372 553	IFR5E11	
MD 372 588	IFR6E11	
MD 373 645	IFR6E11	
MD 374 841	IGR7A-G	
MD 375 642	BKR5ETUA	
MD 378 582	IFR6B	
MN 119 256	ILZFR5B	
MN 119 487	IFR6S	
MN 119 500	IGR6A11	
MN 122 257	BKR6EIX-P	
MN 128 362	LFR6C-11	
MN 158 596	LZFR6AI	
MN 163 235	FR5EI	
MN 163 236	FR6EI	
MN 163 807	FR6EI	
MN 176 628	ILZFR6C-11K	
MN 1822 A002	IFR6B-K	
MN 195 922	ILZFR6C-11K	
MS 851 022	BP5ES	8
MS 851 023	BP6ES	4
MS 851 024	BP7ES	
MS 851 027	BP5ES-11	
MS 851 028	BP6ES-11	
MS 851 029	BP7ES-11	
MS 851 097	BP5EY	
MS 851 101	BP4EY	
MS 851 102	BP5EY	
MS 851 104	BP6EY	
MS 851 106	BP4EY-11	
MS 851 107	BP5EY-11	
MS 851 108	BP6EY-11	
MS 851 111	B-4	
MS 851 113	B6S	
MS 851 121	BP-4	
MS 851 126	BPR6E	2
MS 851 132	B5HS	
MS 851 133	B6HS	
MS 851 134	B7HS	
MS 851 162	B5ES	
MS 851 163	B6ES	
MS 851 164	B7ES	
MS 851 165	B8ES	
MS 851 174	BR7ES	
MS 851 181	BP4ES	
MS 851 182	BP5ES	8
MS 851 182 A	BP5ES	8
MS 851 183	BP6ES	4



<b>mitsubishi</b>	<b>→ NGK</b>	<b>V-Line</b>
MS 851 184	BP7ES	
MS 851 187	BP5ES-11	
MS 851 188	BP6ES-11	
MS 851 189	BP7ES-11	
MS 851 192	BP6ES	4
MS 851 207	BP5ES-11	
MS 851 208	BP6ES-11	
MS 851 212	BP5ES	8
MS 851 213	BP6ES	4
MS 851 215	BP7ES	
MS 851 217	BPR5ES	6
MS 851 218	BPR6ES	2
MS 851 219	BPR7ES	19
MS 851 227	BPR5ES-11	
MS 851 228	BPR6ES-11	13
MS 851 229	BPR7ES-11	
MS 851 230	BPR4ES-11	
MS 851 232	BPR5ES	6
MS 851 233	BPR6ES	2
MS 851 234	BPR7ES	19
MS 851 235	BPR5ES	6
MS 851 236	BPR6ES	2
MS 851 237	BPR5ES-11	
MS 851 238	BPR6ES-11	13
MS 851 239	BPR7ES-11	
MS 851 242	BP4EY	
MS 851 243	BP5EY	
MS 851 244	BP6EY	
MS 851 246	BP4EY-11	
MS 851 247	BP5EY-11	
MS 851 248	BP6EY-11	
MS 851 253	BUR6EA-11	
MS 851 254	BUR7EA-11	
MS 851 263	G-2Z	
MS 851 272	BUR5EA-11	
MS 851 273	BUR6EA-11	
MS 851 274	BUR7EA-11	
MS 851 283	BP6E	4
MS 851 286	BP5EY	
MS 851 287	BP6EY	
MS 851 292	PGR6A-11	
MS 851 301	PGR5A-11	
MS 851 302	PGR6A-11	
MS 851 316	DCPR6E	
MS 851 317	DCPR7E	
MS 851 327	DCPR7EIX	
MS 851 332	PFR6B-11	
MS 851 335	PFR5J-11	
MS 851 336	PFR6J-11	
MS 851 346	PFR6M	
MS 851 347	PFR7M	
MS 851 351	BK5E	

<b>mitsubishi</b>	<b>→ NGK</b>	<b>V-Line</b>
MS 851 352	BK6E	
MS 851 353	BK6E	
MS 851 354	BK5E	
MS 851 357	BKR5E-11	33
MS 851 358	BKR6E-11	14
MS 851 359	BKR7E-11	
MS 851 361	BK5E-11	
MS 851 362	BK6E-11	
MS 851 363	BK7E-11	
MS 851 364	BK5E-11	
MS 851 365	BK6E-11	
MS 851 366	BK7E-11	
MS 851 367	BKR5E	35
MS 851 368	BKR6E	28
MS 851 382	BKR6E	28
MS 851 387	BKR5E-11	33
MS 851 388	BKR6E-11	14
MS 851 396	DCPR6E	
MS 851 397	DCPR7E	
MS 851 402	BPR5E	6
MS 851 403	BPR6ES-11	13
MS 851 408	BPR6ES-11	13
MS 851 412	BPR5ES	6
MS 851 413	BPR6ES	2
MS 851 414	BPR7ES	19
MS 851 417	BPR5ES-11	
MS 851 418	BPR6ES-11	13
MS 851 419	BPR7ES-11	
MS 851 428	BUR6EA-11	
MS 851 429	BUR7EA-11	
MS 851 437	BP5EY	
MS 851 438	BP6ES	4
MS 851 439	BP7ES	
MS 851 447	BUR6EA-11	
MS 851 448	BUR5EA-11	
MS 851 454	BR7ES	
MS 851 463	PGR6A-11	
MS 851 473	PFR6B-11	
MS 851 478	BPR6ES-11	13
MS 851 486	DCPR6E	
MS 851 487	DCPR7E	
MS 851 497	DCPR7EIX	
MS 851 501	PFR5J-11	
MS 851 502	PFR6J-11	
MS 851 506	PFR6J	
MS 851 721	BK5E	
MS 851 722	BK6E	
MS 851 727	BKR5E-11	33
MS 851 728	BKR6E-11	14
MS 851 729	BKR7E-11	
MS 851 732	BK6E-11	
MS 851 737	BKR5E	35



<b>MITSUBISHI</b>	<b>→ NGK</b>	<b>V-Line</b>
MS 851 738	BKR6E	28
MS 851 783	BK7EK-N-11	
MS 851 861	PFR6J	
MS 851 872	BK7EK-N-11	
MS 851 881	BPR6EKN	
MS 851 882	BPR7EKN	
MZ 602 020	BKR5EIX-11	
MZ 602 021	BKR6EIX-11	
MZ 602 022	IRIWAY7	
MZ 602 023	IRIWAY8	
MZ 602 024	IRIWAY9	
MZ 602 026	BCPR5EIX-11	
MZ 602 027	BCPR6EIX-11	
MZ 602 028	IRITOP7	
MZ 602 029	IRITOP8	
MZ 602 030	IRITOP9	
MZ 602 032	BPR5EIX-11	
MZ 602 033	BPR6EIX-11	
MZ 602 034	BPR7EIX	
MZ 602 035	BR8EIX	
MZ 602 036	BR9EIX	
MZ 602 037	DCPR7EIX	
MZ 602 040	BKR5EIX-11P	
MZ 602 041	BKR6EIX-11P	
MZ 602 042	BKR7EIX-P	
MZ 602 043	BCPR5EIX-11P	
MZ 602 044	BCPR6EIX-11P	
MZ 602 049	DCPR7EIX-P	
MZ 602 060	BPR5EIX-11	
MZ 602 061	BPR6EIX-11	
MZ 602 062	BPR7EIX	
MZ 602 063	BCPR5EIX-11	
MZ 602 064	BCPR6EIX-11	
MZ 602 065	BKR5EIX-11	
MZ 602 066	BKR6EIX-11	
MZ 602 067	DCPR7EIX	
MZ 602 068	ZFR5FIX-11	
MZ 602 069	ZFR6FIX-11	
MZ 602 070	BPR5EIX	
MZ 602 071	BPR6EIX	
MZ 602 072	BKR5EIX	
MZ 602 073	BKR6EIX	
MZ 602 074	LPG2	
MZ 602 075	LPG1	
MZ 602 076	BKR5EIX-11P	
MZ 602 077	BKR6EIX-11P	
MZ 602 078	BCPR5EIX-11P	
MZ 602 079	BCPR6EIX-11P	
MZ 602 080	DCPR7EIX-P	
MZ 602 081	BKR7EIX-11	
MZ 602 082	BKR5EIX-P	
MZ 602 083	BKR6EIX-P	

<b>MITSUBISHI</b>	<b>→ NGK</b>	<b>V-Line</b>
MZ 602 084	ZFR5FIX-11P	
MZ 602 085	ZFR6FIX-11P	
S MD 313 443	PFR6G-11	
S MN 158 596	LZFR6AI	
SS MS 851 364	BK5E-11	
Z2 152 944	BPR6ES-11	13
Z2 152 945	BPR6ES	2
Z2 152 946	BR7ES	
Z2 152 947	BPR7ES	19
Z2 152 948	BPR7ES-11	
Z2 152 949	BCPR7ES-11	
Z2 152 950	BCPR6ES-11	11
<b>MOTORCRAFT</b>	<b>→ NGK</b>	<b>V-Line</b>
1 Y 00	BPR5ES	6
1 Y 01	BPR6ES	2
1 Y 03	BPR5ES-11	
1 Y 06	BKR5E	35
1 Y 07	BKR6E	28
1 Y 09	BKR5E-11	33
1 Y 0 A	BKR6E-11	14
1 Y 0 B	BKR7E-11	
1 Y 0 F	DCPR7E	
1 Y 0 G	ZFR5F-11	
1 Y 0 H	ZFR6F-11	
1 Y 0 K	BPR5ES-13	
1 Y 0 L	BRE527Y-11	
1 YR 7	BKR6EIX-P	
1 YR 9	BKR5EIX-11P	
1 YRA	BKR6EIX-11P	
1 YRF	DCPR7EIX-P	
1 YRG	ZFR5FIX-11P	
1 YRH	ZFR6FIX-11P	
A 1	B8S	
A 11	B-2	
A 11 NX	BM4A	
A 11 U	B-2	
A 11 X	B-2	
A 1 CU	B8S	
A 1 X	B8S	
A 2	B7S	
A 21 X	B8S	
A 22	BP6S	
A 22 CU	BP6S	
A 22 NX	BPM7A	
A 2 NX	BM7A	
A 2 X	B7S	
A 3	B6S	
A 32	BP6S	
A 3 CU	B6S	
A 3 NX	BM6A	
A 3 X	B6S	





MOTORCRAFT	→ NGK	V-Line
A 4	B6S	
A 42	BP5S	
A 42 CU	BP5S	
A 5	B6S	
A 52	BP5S	
A 52 CU	BP5S	
A 5 CU	B6S	
A 5 X	B6S	
A 7	B-4	
A 7 LM	B4-LM	
A 7 N	BM6A	
A 7 NU	BM6A	
A 7 NX	BM6A	
A 7 U	B-4	
A 7 X	B-4	
A 82	BP-4	
A 9	B-4	
A 901	B8S	
A 9 X	B-4	
AE 1 C	B7HS	
AE 1 X	B7HS	
AE 2	B7HS	
AE 22	BP6HS	18
AE 22 C	BP6HS	18
AE 2 C	B7HS	
AE 2 X	B7HS	
AE 3	B6HS	
AE 32	BP6HS	18
AE 32 C	BP6HS	18
AE 3 C	B6HS	
AE 3 X	B6HS	
AE 4	B5HS	
AE 42	BP5HS	
AE 4 X	B5HS	
AE 52	BP5HS	
AE 6	B5HS	
AE 62	BP5HS	
AE 7	B-4H	
AE 8	B-4H	
AE 901	B9HS	
AE 901 X	B9HS-10	
AE 92	BP-4H	
AER 32	BPR6HS	3
AER 4	BR5HS	
AER 4 X	BR5HS	
AF 12	BP7FS	
AF 2	B7FS	
AF 22	BP6FS	
AF 3	BR6FS	
AF 32	BP6FS	
AF 3 NX	BM7F	
AF 42	BP5FS	

MOTORCRAFT	→ NGK	V-Line
AF 52	BP4FS	
AF 5 NX	BM6F	
AG 1	B8ES	
AG 12	BP7ES	
AG 12 C	BP7ES	
AG 12 CU	BP7ES	
AG 1 C	B8ES	
AG 1 X	B8ES	
AG 2	B7ES	
AG 203	B11EGP	
AG 22	BP6ES	4
AG 224	BP6ES-11	
AG 22 C	BP6ES	4
AG 22 CU	BP6ES	4
AG 23	B7ECS	
AG 252	BP6ES	4
AG 252 C	BP6ES	4
AG 25 C	B7EM	
AG 2 C	B7ES	
AG 2 CU	B7ES	
AG 2 X	B7ES	
AG 3	B6ES	
AG 32 A	BP6ES	4
AG 32 C	BP6ES	4
AG 32 CU	BP6ES	4
AG 34 CU	BP6EY	
AG 34 CU 11	BP6EY-11	
AG 3 C	B6ES	
AG 3 X	B6ES	
AG 4	B5ES	
AG 403	B10EGP	
AG 403 C	B10EGP	
AG 42	BP5ES	8
AG 42 CU	BP5ES	8
AG 44	ZGR5C	
AG 44 CU	BP5EY	
AG 5	B5ES	
AG 501	B10ES	
AG 501 X	B10EGV	
AG 52	BP5ES	8
AG 54	ZGR5C	
AG 54 CU	BP4EY	
AG 5 CU	B5ES	
AG 603	BR9EIX	
AG 603 C	BR9EIX	
AG 7	B5ES	
AG 701	B9ES	
AG 701 C	B9ES	
AG 701 CU	B9ES	
AG 701 X	B9EGV	
AG 82	BP4ES	
AG 9	B4ES	



MOTORCRAFT	→ NGK	V-Line
AG 901	B9ES	
AG 901 C	B9ES	
AG 901 CU	B9ES	
AG 901 X	B8EGV	
AG 902	BP8ES	
AG 903	B8EG	
AG 9 U	B4ES	
AGF 12	BP7EFS	
AGF 12 C	BP7EFS	
AGF 22 C	BP6EFS	5
AGF 32 CU	BP6EFS	5
AGFS 22 C 1	BPR6EFS	7
AGFS 22 FE 1	PTR6F-13	
AGFS 22 FE 13 J	PTR6D-13G	
AGFS 22 IPJ	ITR6F13	
AGFS 22 YPC	ITR6F13	
AGFS 32 C 1	BPR6EFS	7
AGKO	BUE	
AGN 42	BP5ES	8
AGP 12 C	BCP7ES	
AGP 22 C	BCP6ES	17
AGP 701 C	R7436-10	
AGPR 12 C	BCPR7ES	
AGPR 12 P	BKR7EIX-11	
AGPR 12 PP	PFR7B-11	
AGPR 12 PP 11	PFR7B-11	
AGPR 12 PP 8	PFR7B	
AGPR 22 C	BKR6ES	28
AGPR 22 C 1	BKR6ES-11	14
AGPR 22 CD	BKR6ES	28
AGPR 22 CD 1	BKR6ES-11	14
AGPR 22 P	BKR6EIX-11	
AGPR 22 PP	PFR6B-11	
AGPR 22 PPJ	PFR6B-11	
AGPR 32 C	BKR6ES	28
AGPR 32 CD 1	BKR6ES-11	14
AGPR 32 PD	BKR5EKUP	
AGPR 902 C	BCPR9ES-11	
AGPR 902 P	R7436-9	
AGPS 12 C	BCPR7ES	
AGPS 12 P 1	BKR7EIX-11	
AGPS 22 C	BKR6ES	28
AGPS 22 C 1	BKR6ES-11	14
AGPS 22 P	BKR6EIX-11	
AGPS 22 P 1	BKR6EIX-11	
AGPS 22 PP 1	PFR6B-11	
AGPS 32 C	BKR6ES	28
AGPS 32 C 1	BKR6ES-11	14
AGPS 44 F	PZFR5D-11	34
AGPS 44 F 11	PZFR5D-11	34
AGPS 44 F 11 J	PZFR5D-11	34
AGR 12 C	BPR7ES	19

MOTORCRAFT	→ NGK	V-Line
AGR 16 C	BR8ET	
AGR 1 X	BR8ES	
AGR 21	BR6ES	
AGR 22	BPR6ES	2
AGR 22 C	BPR6ES	2
AGR 22 CU	BPR6ES	2
AGR 2 C	BR7ES	
AGR 31	BR6ES	
AGR 32	BPR6ES	2
AGR 32 C	BPR6ES	2
AGR 32 CU	BPR6ES	2
AGR 34 CU	BPR6EY	
AGR 3 X	BR6ES	
AGR 41	BR5ES	
AGR 42	BPR5ES	6
AGR 42 C	BPR5ES	6
AGR 42 CU	BPR5ES	6
AGR 44 CU	BPR5EY	9
AGR 44 CU 11	BPR5EY-11	
AGR 47 CU 11	ZGR5B-11	
AGR 51	BR5ES	
AGR 52	BPR5ES	6
AGR 54 CU	BPR5EY	9
AGR 701 X	BR9EIX	
AGR 82	BPR4ES	
AGR 901 X	BR8EIX	
AGRF 22	BPR6EFS	7
AGRF 226	BPR6EFS-13	
AGRF 22 C	BPR6EFS	7
AGRF 22 C 1	BPR6EFS	7
AGRF 22 PP 1	PTR5D-10	31
AGRF 32	BPR6EFS	7
AGRF 326	BPR6EFS-13	
AGRF 32 C 1	BPR6EFS	7
AGRF 42	BPR5EFS	
AGRF 52	BPR5EFS	
AGRP 52	ZFR4F-11	
AGS 22 C	BPR6ES	2
AGS 32 C	BPR5ES	6
AGS 32 C 11	BPR5ES-11	
AGS 42 CC	BPR4ES	
AGSF 22 FM 1	TR5IX	
AGSF 22 FSCM	PTR6D-13G	
AGSF 22 PGM	PTR6F-13	
AGSF 22 PM	PTR6F-13	
AGSF 22 PP	PTR6F-13	
AGSF 22 PPJ	PTR6F-13	
AGSF 22 PPM	PTR6F-13	
AGSF 22 WM	BPR5EFS	
AGSF 22 YPC	ITR6F13	
AGSF 24 C	TR5-1	
AGSF 24 N	TR55-1	



<b>MOTORCRAFT</b>	<b>→ NGK</b>	<b>V-Line</b>
AGSF 32 C	BPR5EFS	
AGSF 32 FEC	PTR5F-11	
AGSF 32 FEM	PTR5D-10	31
AGSF 32 FM	PTR5D-13	
AGSF 32 W	TR55IX	
AGSF 32 WM	ITR6F13	
AGSF 32 YPC	TR5AI-13	
AGSF 34 C	TR5-1	
AGSP 32	BKR6ES-11	14
AGSP 32 C	BKR6ES-11	14
AGSP 32 FP	PFR5G-11	
AGSP 32 PR	PFR6B-11	
AGSP 33 C	ZFR6F-11	
AGSP 52	BKR5ES	35
AL 11	B-4L	
AL 5	B-6L	
AL 5 X	B-6L	
AL 7	B-6L	
AL 7 U	B-6L	
AL 7 X	B-6L	
AL 9	B-4L	
AL 9 X	B-4L	
AR 21 X	BR6S	
AR 31	BR6S	
AR 32	BP6S	
AR 41	BR6S	
AR 42	BP5S	
AR 51	BR6S	
AR 52	BP5S	
AR 7 N	BMR6A	
AR 82	BP-4	
ARF 2	BR6FS	
ARF 22	BPR6FS	
ARF 22 C	BPR6FS	
ARF 22 CU	BPR6FS	
ARF 26	BR6FS	
ARF 3	BR6FS	
ARF 32	BPR6FS	
ARF 326	BPR6FS	
ARF 32 C 6	BPR6FS	
ARF 32 M	BPR6FS	
ARF 36	BR6FS	
ARF 4	BR5FS	
ARF 41 CU 15	BR5FS	
ARF 42	BPR5FS	
ARF 426	BPR5FS-15	
ARF 42 CU	BPR5FS	
ARF 46	BR5FS	
ARF 52	BPR4FS	
ARF 526	BPR4FS-15	
ARF 6	BR5FS	
ARF 62	BPR4FS	

<b>MOTORCRAFT</b>	<b>→ NGK</b>	<b>V-Line</b>
ARF 626	BPR4FS-15	
ARF 8	BR5FS	
ARF 86	BR5FS	
ASF 32	BPR6FS	
ASF 32 C	BPR6FS	
ASF 32 M	BPR6FS	
ASF 32 P	UR5IX	
ASF 42	BPR5FS-11	
ASF 426 C	BPR5FS-15	
ASF 42 C	BPR5FS-11	
ASF 42 P	UR4IX	
ASF 44 P	UR4IX	
ASF 52	BPR4FS	
ASF 526	BPR4FS-15	
AT 1	B8S	
AT 10	B-2	
AT 2	B7S	
AT 3	B6S	
AT 4	B6S	
AT 42	BP5S	
AT 42 M	BP5S	
AT 4 A	B6S	
AT 6	B6S	
AT 8	B-4	
ATL 3	B-6L	
ATL 4	B-6L	
ATL 8	B-4L	
AV 1 X	B8HS	
AV 22 CU	BP6HS	18
AV 2 CU	B7HS	
AV 2 X	B7HS	
AV 3 CU	B6HS	
AV 4	B5HS	
AV 42	BP5HS	
AV 52	BP5HS	
AV 6	B-4H	
AV 6 CU	B-4H	
AV 701 CU 10	B9HS-10	
AV 82	BP-4H	
AV 901 CU	B9HS	
AV 901 X 4	B9HS-10	
AVKO	BUH	
AVKOD	BUHW	
AVZKO	BUHX	
AWRF 32	BPR6EFS	7
AWRF 325	BPR6EFS-13	
AWRF 42	BPR5EFS	
AWSF 22 C	BPR6EFS	7
AWSF 22 E	TR6IX	
AWSF 22 F	PTR6D-13	
AWSF 22 FM	TR5IX	
AWSF 22 FM 1	TR5IX	



MOTORCRAFT	→ NGK	V-Line
AWSF 22 FS	PTR6D-13G	
AWSF 24 C	TR5-1	
AWSF 32	BPR6EFS	7
AWSF 32 C	BPR6EFS	7
AWSF 32 E	TR55IX	
AWSF 32 EE	TR55IX	
AWSF 32 F	PTR5D-10	31
AWSF 32 FM	TR5IX	
AWSF 32 P	TR5IX	
AWSF 32 PM	TR5IX	
AWSF 32 PP	TR5IX	
AWSF 34	TR5-1	
AWSF 34 C	TR5-1	
AWSF 34 PP	TR5-1IX	
AWSF 42	BPR5EFS	
AWSF 42 C	BPR5EFS	
AWSF 42 EE	TR55IX	
AWSF 42 PP	TR55IX	
AWSF 44 C	TR5-1	
AWSF 52 C	BPR5EFS	
AWSF 54	TR5-1	
AWSF 54 C	TR5-1	
AWSFA 32 C	BPR5EFS	
AYFS 22 C	PTR5A-13	25
AYFS 22 FE 1 J	PLTR6A-10G	
AYFS 22 FPM 1	PTR5A-13	25
AYFS 22 PP	PTR5A-13	25
AYFS 22 PP 1	PTR5A-13	25
AYFS 32 CJ	TR5B-13	
AYRF 22 P	PTR5A-13	25
AYRF 22 PP	PTR5A-13	25
AYSF 32 YPC	ILTR5A-13G	
AZ 2	B7S	
AZ 3	B6S	
AZ 9	B-4	
AZ 901	B8S	
AZFS 22 C	PTR5A-13	25
AZFS 22 PP	PTR5A-13	25
AZFS 32 FE	PTR5A-13	25
B 2	AB-8	
B 2 W	AB-8	
B 3 W	AB-7	
B 3 X	AB-7	
B 4	AB-7	
B 4 X	AB-7	
B 6	AB-6	
B 6 W	AB-6	
B 8	AB-6	
B 8 X	AB-6	
B 9	AB-6	
BF 1	A7FS	
BF 12	AP8FS	

MOTORCRAFT	→ NGK	V-Line
BF 22	AP6FS	
BF 22 C	AP6FS	
BF 22 CU	AP6FS	
BF 22 CX	AP6FS	
BF 22 X	AP6FS	
BF 3	A6FS	
BF 32	AP6FS	
BF 32 CU	AP6FS	
BF 32 CX	AP6FS	
BF 32 X	AP6FS	
BF 42	AP5FS	
BF 42 CU	AP5FS	
BF 601	A9FS	
BF 82	AP5FS	
BF 901	A8FS	
BF 92	AP5FS	
BFS 22 C	APR6FS	
BFS 32 C	APR6FS	
BFS 32 C 1	APR6FS	
BR 8	AB-6	
BRF 22	APR6FS	
BRF 22 C	APR6FS	
BRF 31	AR6FS	
BRF 314	AR6FS	
BRF 32	APR6FS	
BRF 3 M	AR6FS	
BRF 42	APR5FS	
BRF 82	APR5FS	
BSF 31	AR6FS	
BSF 314	AR6FS	
BSF 82	APR5FS	
BSF 92	APR5FS	
BT 10	AB-6	
BT 15	AB-2	
BT 2	AB-8	
BT 3	AB-7	
BT 4	AB-7	
BT 6	AB-6	
BT 8	AB-6	
BT 9	AB-6	
BTF 1	A7FS	
BTF 3	A6FS	
BTF 31	A6FS	
BTF 42	AP5FS	
BTF 6	A6FS	
BTRF 42	APR5FS	
BZ 8	AB-6	
HE 1	D10HS	
HE 2	D8HA	
HE 3	D6HA	
HG 2	D8EA	
HG 22	D8EA	



MOTORCRAFT	→ NGK	V-Line
HG 2 CU	D8EA	
HGR 2 C	DR8ES-L	
HV 2	D8HA	
HV 22	D6HA	
HV 3	D6HA	
PE 3	C6HSA	
PV 2	C7HSA	
PV 3	C6HSA	
TT 4	G-2Z	
TT 8	G-2Z	

#### NHSP LD => TORCH

NISSAN	→ NGK	V-Line
22401-01B14	BPR5ES-11	
22401-01M14	BP4ES-L-11	
22401-01P14	BCPR4ES-11	
22401-01P15	BCPR5ES-11	
22401-01P16	BCPR6ES-11	11
22401-01P17	BCPR7ES-11	
22401-01P75	BCPR5ES-11	
22401-01P76	BCPR6ES-11	11
22401-01P90	BCPR5ES-11	
22401-01P91	BCPR6ES-11	11
22401-02P15	BCPR5E-11	
22401-02P16	BCPR6E-11	11
22401-02P17	BCPR7E-11	
22401-03300	B-4	
22401-08U15	PFR5K-11	
22401-08U75	PFR5K-11	
22401-0P615	PFR5F-11A	
22401-0P616	PFR6F-11A	
22401-0P675	PFR5F-11A	
22401-0P676	PFR6F-11A	
22401-10F14	BCPR4ES-11	
22401-10F15	BCP5ES	16
22401-10F16	BCP6ES	17
22401-10F17	BCP7ES	
22401-10P15	BCPR5E-11	
22401-10P16	BKR6E-11	14
22401-10P17	BCPR7E-11	
22401-11200	BC6ES	
22401-12E14	BCPR4ES-11	
22401-12E15	BCPR5ES	32
22401-12E16	BCPR6ES	12
22401-12E17	BCPR7ES	
22401-12E76	BCPR6ES	12
22401-18V15	PGR5A	
22401-18V16	PGR6A	
22401-18V17	PGR7A	
22401-19V15	BCP5ES	16
22401-19V16	BCP6ES	17

NISSAN	→ NGK	V-Line
22401-19V17	BCP7ES	
22401-19V65	BCPR5ES	32
22401-19V66	BCPR6ES	12
22401-1A50A	ILFR5B11	
22401-1F720	BKR5E-11	33
22401-1HC1B	LZKAR6AP-11	
22401-1KT1B	DILZKAR6A11	
22401-1KT7B	DILZKAR6A11	
22401-1N506	BKR6E-N	
22401-1N516	BKR6E-N	
22401-1N567	PFR7G-11	
22401-1P114	PFR4G-11	
22401-1P115	PFR5G-11	
22401-1P116	PFR6G-11	
22401-1P117	PFR7G-11	
22401-1P175	PFR5G-11	
22401-1P175-Q0	PFR5G-11	
22401-1P175-VA	PFR5G-11	
22401-1P176	PFR6G-11	
22401-1P176-VA	PFR6G-11	
22401-1P176-WS	PFR6G-11	
22401-1W615	FR5AP-10	
22401-1W675	FR5AP-10	
22401-20J04	BKR4E	
22401-20J05	BKR5E	35
22401-20J05-Q0	BKR5E	35
22401-20J05-SN	BKR5E	35
22401-20J05-VA	BKR5E	35
22401-20J05-W0	BKR5E	35
22401-20J06	BKR6E	28
22401-20J07	BKR7E	
22401-20J16	BKR6E	28
22401-21B15	BPR5E	6
22401-21B16	BPR6E	2
22401-21B17	BPR7E	19
22401-27N15	PFR5B-11	
22401-27N15-VA	PFR5B-11	
22401-27N15-VB	PFR5B-11	
22401-27N16	PFR6B-11	
22401-27N64	PFR4B-11	
22401-27N65	PFR5B-11	
22401-27N66	PFR6B-11	
22401-27N67	PFR7B-11	
22401-27T15	PGR5A-11	
22401-27T65	PGR5A-11	
22401-27T66	PGR6A-11	
22401-2J200	BKR5EY-11	
22401-2J200-Q0	BKR5EY-11	
22401-2J200-VA	BKR5EY-11	
22401-2J206	BKR6EY-11	
22401-2J206-VA	BKR6EY-11	
22401-30R14	ZFR4E-11	





NISSAN	→ NGK	V-Line
22401-30R15	ZFR5E-11	
22401-30R16	ZFR6E-11	
22401-30R75	ZFR5E-11	
22401-30R75-W1	ZFR5E-11	
22401-37P15	PFR5B-11C	
22401-37P16	PFR6B-11C	
22401-37P76	PFR6B-11C	
22401-40F15	ZFR5D-11	
22401-40P15	PFR5B-11B	
22401-40P65	PFR5B-11B	
22401-40P66	PFR6B-11B	
22401-40V05	BCP5E	16
22401-40V06	BCP6E	17
22401-40V07	BCPR7E	
22401-50Y04	BKR4E-11	
22401-50Y05	BKR5E-11	33
22401-50Y05-Q0	BKR5E-11	33
22401-50Y05-VA	BKR5E-11	33
22401-50Y05-W0	BKR5E-11	33
22401-50Y06	BKR6E-11	14
22401-50Y07	BKR7E-11	
22401-50Y75	BKR5E-11	33
22401-50Y75-W0	BKR5E-11	33
22401-53J04	BKR4EY	
22401-53J05	BKR5EY	
22401-53J05-VA	BKR5EY	
22401-53J06	BKR6EY	
22401-53J06-RB	BKR6EY	
22401-53J06-VA	BKR6EY	
22401-53J07	BKR7EY	
22401-53J15	PFR5B-9	
22401-53J65	PFR5B-9	
22401-53J66	PFR6B-9	
22401-53J67	PFR7B-9	
22401-53V15	PFR5B-9	
22401-53V16	PFR6B	
22401-53V17	PFR7B	
22401-54C68	PFR8B-9	
22401-55V17	PFR7B-D	
22401-58S15	PFR5A-11	
22401-58S16	PFR6A-11	
22401-58S17	PFR7A-11	
22401-59S16	PFR6A-11	
22401-5M015	PLFR5A-11	
22401-5M016	PLFR6A-11	
22401-5M075	PLFR5A-11	
22401-5M075-Q0	PLFR5A-11	
22401-5M075-SN	PLFR5A-11	
22401-5M075-VA	PLFR5A-11	
22401-5M075-W0	PLFR5A-11	
22401-60V06	BCPR6ES-11	11
22401-6N215	LZFR5AQP	

NISSAN	→ NGK	V-Line
22401-85E15	BKR5ES-11	33
22401-85E16	BKR6ES-11	14
22401-85E17	BKR7ES-11	
22401-85E75	BKR5ES-11	33
22401-85E76	BKR6ES-11	14
22401-88G75	BKR5EY	
22401-88G75-WS	BKR5EY	
22401-88G76	BKR6EY	
22401-88G76-WS	BKR6EY	
22401-8H314	LFR4AP-11	
22401-8H315	LFR5AP-11	
22401-8H375	LFR5AP-11	
22401-8H375-VA	LFR5AP-11	
22401-8H515	LFR5A-11	
22401-8H516	LFR6A-11	
22401-8H575	LFR5A-11	
22401-8H575-Q0	LFR5A-11	
22401-8H616	PLFR6A-9	
22401-8H676	PLFR6A-9	
22401-97E15	PFR5C-11	
22401-97E65	PFR5C-11	
22401-98E06	BKR6ES-11	14
22401-9E075	FR5AP-10	
22401-AG215	PFR5P-11	
22401-AG275	PFR5P-11	
22401-AG315	BKR5EQUPA	
22401-AJ415	FR5AP-11	
22401-AL615	LFR5AQP	
22401-AL875	LFR5BP-11	
22401-AR015	LFR5AQP	
22401-AR716	LFR6A	
22401-BC01B	LFR5E-11	
22401-CK81	PLZKAR6A-11	
22401-CK81B	PLZKAR6A-11	
22401-CK87B	PLZKAR6A-11	
22401-CK87B-VA	PLZKAR6A-11	
22401-EA015	PLZKAR6A-11	
22401-ED815	LZKAR6AP-11	
22401-ED875	LZKAR6AP-11	
22401-ED875-Q0	LZKAR6AP-11	
22401-ED875-SN	LZKAR6AP-11	
22401-ED875-VA	LZKAR6AP-11	
22401-EW61B	DILKAR6A11	
22401-EW61C	DF7H-11B	
22401-EW67B	DILKAR6A11	
22401-F6516	PFR6A-11A	
22401-FU412	FR2A-D	
22401-FU42A	FR2B-D	
22401-HC000	BPR5ES-13	
22401-HC001	BPR6ES-13	
22401-JA01B	DILKAR6A11	
22401-JA07B	DILZKAR6A11	



NISSAN	→ NGK	V-Line
22401-JK01D	DF8H-11B	
22401-L1600	BP-2E	
22401-M7714	B4ES	
22401-M7715	B5ES	
22401-M7716	B6ES	
22401-M7717	B7ES	
22401-M7915	BR5ES	
22401-M7916	BR6ES	
22401-M7917	BR7ES	
22401-N8714	BP4ES-11	
22401-N8715	BP5ES-11	
22401-N8716	BP6ES-11	
22401-N8717	BP7ES-11	
22401-N8785	BP5ES-11	
22401-N8786	BP6ES-11	
22401-N8789	BP6ES-11	
22401-N8790	BP5ES-11	
22401-N8791	BP6ES-11	
22401-P8314	BPR4ES-11	
22401-P8315	BPR5ES-11	
22401-P8316	BPR6ES-11	13
22401-P8317	BPR7ES-11	
22401-P8385-PC	BPR5ES-11	
22401-P8386-PC	BPR6ES-11	13
22401-P8389	BPR4ES-11	
22401-P8390	BPR5ES-11	
22401-P8391	BPR6ES-11	13
22401-P8614	BR4ES	
22401-P8616	BR6ES-11	
22401-P8617	BR7ES	
22401-P8816	B6ES-11	
22401-P8817	B7ES-11	
22401-S6015	BP5ES-13	
22401-S6016	BP6ES-13	
22401-V0515	BP5ES	8
22401-V0516	BP6ES	4
22401-V1414	BPR4ES	
22401-V1414-WL	BPR4ES	
22401-V1415	BPR5ES	6
22401-V1416	BPR6ES	2
22401-V1417	BPR7ES	19
22401-V1484-PC	BPR4ES	
22401-V1485-PC	BPR5ES	6
22401-V1486-PC	BPR6ES	2
22401-V1490	BPR5ES	6
22401-V1491	BPR6ES	2
22401-V5014	BCPR4ES-11	
22401-V5015	BCP5ES-11	
22401-V5016	BCP6ES-11	
22401-V5017	BKR7E-11	
22401-V5085	BCP5ES-11	
22401-V5086	BCP6ES-11	

NISSAN	→ NGK	V-Line
22401-VB000	BPR5E-11	
22401-VB006	BPR6E-11	
22401-VR306	IGR6B-10D	
22401-W8914	BP4ES	
22401-W8914-WL	BP4ES	
22401-W8915	BP5ES	8
22401-W8915-SA	BP5ES	8
22401-W8916	BP6ES	4
22401-W8917	BP7ES	
22401-W8985	BP5ES	8
22401-W8985-PC	BP5ES	8
22401-W8986	BP6ES	4
22401-W8986-PC	BP6ES	4
22401-W8990	BP5ES	8
22401-W8991	BP6ES	4
22401-W9815	BPR5ES	6
22401-W9816	BPR6ES	2
22401-W9817	BPR7ES	19
22401-WA016	PFR6G-9	
22401-WA066	PFR6G-9	
22401-WA067	PFR7G-9	
22401-WD517	FR7AI-D	
22401-Y9015	BCPR5ET	
22401-Y9016	BCPR6ET	
22401-Y9017	BCPR7ET	
22401-Y9065	BCPR5ET	
22401-Y9066	BCP6ET	
22401-Y9067	BCP7ET	
22401-Y9215	BPR5ES	6
22401-Y9264	BP4ES	
22401-Y9265	BP5ES	8
22401-Y9266	BP6ES	4
22401-ZE01B	DILFR5A11	
B2401-4A00A	IKR6G11	
B2401-89900	BPR5EIX	
B2401-89904	BP5EY	
B2401-89905	BP6EY	
B2401-89906	BCPR5EIX-11	
B2401-89907	BCPR6EIX-11	
B2401-89908	BPR5EY	9
B2401-89909	BPR6EY	
B2401-M7715	B5ES	
B2401-M7915	BR5ES	
B2401-V1415	BPR5ES	6
B2401-V1416	BPR6ES	2
B2401-W8914	BP4ES	
B2401-W8915	BP5ES	8
B2401-W8916	BP6ES	4
B2401-W8917	BP7ES	
BY480-BKR5E	BKR5EIX	
BY480-BKR6E	BKR6EIX	
BY480-BPR5E	BPR5EIX	



NISSAN	→ NGK	V-Line
BY480-BPR6E	BPR6EIX	
BY480-BPR7E	BPR7EIX	
BY480-BPR8E	BPR8EIX	
BY480-BPR9E	BPR9EIX	
BY480-DCPR7	DCPR7EIX	
BY481-BCPR5	BCPR5EIX-11	
BY481-BCPR6	BCPR6EIX-11	
BY481-BKR5E	BKR5EIX-11	
BY481-BKR6E	BKR6EIX-11	
BY481-BKR7E	BKR7EIX-11	
BY481-BPR5E	BPR5EIX-11	
BY481-BPR6E	BPR6EIX-11	
BY481-LFR5A	LFR5AIX-11	
BY481-LFR6A	LFR6AIX-11	
BY481-ZFR5F	ZFR5FIX-11	
BY481-ZFR6F	ZFR6FIX-11	
BY482-BKR6E	LPG1	
BY482-BPR6E	LPG2	
BY483-BCPR5	BCPR5EIX-11P	
BY483-BCPR6	BCPR6EIX-11P	
BY483-BKR5E	BKR5EIX-11P	
BY483-BKR6E	BKR6EIX-11P	
BY483-HB6AI	HB6AIX-11P	
BY483-HB6BI	HB6BIX-11P	
BY483-LFR5A	LFR5AIX-11P	
BY483-LFR6A	LFR6AIX-11P	
BY483-ZFR5F	ZFR5FIX-11P	
BY483-ZFR6F	ZFR6FIX-11P	
BY484-BKR5E	BKR5EIX-P	
BY484-BKR6E	BKR6EIX-P	
BY484-BKR7E	BKR7EIX-P	
BY484-DCPR7	DCPR7EIX-P	
BY484-LFR6A	LFR6AIX-P	
BY484-LFR7A	LFR7AIX-P	
OPEL	→ NGK	V-Line
12 14 000	BKR5EK	23
12 14 011	BKR5EQUPA	
12 14 013	LTR6B-10T	
12 14 014	PZTR5A-15	
12 14 016	ZFR6V-G	
12 14 030	PFR6T-10G	
12 14 031	ZFR5F-11	
12 14 046	PFR6T-G	
12 14 060	PFR6D10G	
12 14 065	DILFR7B10G	
12 14 066	IFR7X7G	
12 14 149	BKR5EK	23
12 14 527	PLFR6C-10G	
12 14 528	ZFR6BP-G	
44 13 288	PFR6G-9	
47 08 892	IKR6G11	

OPEL	→ NGK	V-Line
48 11 581	ILTR5D	
09 195 109	BKR5EK	23
09 195 868	BKR5EQUPA	
09 199 038	LTR6B-10T	
12 563 707	PZTR5A-15	
12 620 540	ILTR5D	
12 787 099	PFR6T-10G	
12 788 884	PLFR6C-10G	
25 324 618	LTR6B-10T	
55 182 623	FR5CP	
55 562 534	PFR6T-G	
55 564 215	BKR7ESC-11	
55 564 748	DILFR7B10G	
55 564 763	ZFR6BP-G	
55 565 219	ZFR6V-G	
55 571 391	PFR6D10G	
55 576 026	IFR7X7G	
90 239 568	BPR6ES	2
90 239 569	BPR6HS	3
90 336 461	BKR6ES	28
90 338 179	BCPR6ET	
90 355 136	BPR6ES	2
90 356 323	BPR5ES	6
90 357 729	BKR6EK	20
90 357 780	BKR6ES	28
90 423 215	BKR6ES	28
90 512 989	BKR5EK	23
93 161 199	PFR6G-9	
93 193 723	IKR6G11	
PEUGEOT => PSA		
PONTIAC => GM		
PORSCHE	→ NGK	V-Line
958 170 222 90	ILZKR8A	
999 170 223 90	BKR7EQUP	
PSA	→ NGK	V-Line
5960.14	LFR5B	
5960.81	PLFR5A-11	
5960.92	PLZKBR7A-G	
5960.93	PLZKBR7A-G	
5960.A5	PLZKBR7A-G	
5960.C2	FR5EI	
5960.C3	FR5EI	
5960.E1	PLZKBR7A-G	
5960.E2	PLZKBR7A-G	
5960.G4	PLZKBR7A-G	
5960.H9	PLZKBR7A-G	
5960.L0	PLZKBR7A-G	



PSA	→ NGK	V-Line
5960.L5	ILZKBR7A-8G	
5962.00	BCP6ES	17
5962.05	BP6EFS	5
5962.09	BP6EFS	5
5962.13	BP6ES	4
5962.14	BP6EFS	5
5962.15	BP6EFS	5
5962.16	BP6ES	4
5962.21	BUR6ET	1
5962.22	BPR6EIX	
5962.2A	BPR6ES	2
5962.2T	BKR6EKC	26
5962.2X	BKR6ES	28
5962.5G	BKR6EZ	38
5962.71	BKR6ES	28
5962.72	BP6EFS	5
5962.7S	BKR6EZ	38
5962.7W	LFR6B	
5962.80	BP6HS	18
5962.82	BP6ES	4
5962.87	BP6EFS	5
5962.88	BP8ES	
5962.90	BP6HS	18
5962.94	BP7ES	
5962.98	BP7ES	
5962.A1	BP7ES	
5962.A2	BP6ES	4
5962.A3	BP6HS	18
5962.A5	PLZKBR7A-G	
5962.A0	BP7ES	
5962.C5	BKR6ES	28
5962.C6	BKR6ES	28
5962.C0	BP5EFS	
5962.F7	BCP6ES	17
5962.F8	BCP6ES	17
5962.G8	BP7ES	
5962.H2	BKR6ES	28
5962.H8	BKR5ES	35
5962.H9	BKR5ES	35
5962.IA	BP5ET	
5962.IK	BKR6EK	20
5962.IL	BKR5EK	23
5962.J9	BKR6ES	28
5962.J0	BCP6ES	17
5962.K1	BCPR7ES	
5962.K3	BCP7ET	
5962.K4	BKR6ES	28
5962.K6	BKR6ES	28
5962.K7	BCPR6ET	
5962.K0	BCPR7ES	
5962.OE	BKR6EK	20
5962.R5	BCPR6ET	

PSA	→ NGK	V-Line
5962.R9	BKR6ES	28
5962.S2	BKR6ES	28
5962.S4	BKR5ES	35
5962.S7	BP5ES	8
5962.T8	BKR6ES	28
5962.T0	BKR6ES	28
5962.V6	BKR5ES	35
5962.V7	BKR6ES	28
5962.V8	BCPR7ES	
5962.W1	BKR5ES	35
5962.W4	BCPR6ET	
5962.W6	BCPR7ES	
5962.W7	BCPR7ES	
5962.W9	BKR5EK	23
5962.X5	BCP6ES	17
5962.X8	BCP6ES	17
5962.Y2	BKR5EK	23
5962.Y8	BKR6EK	20
5962.Z1	BKR6EK	20
5962.Z6	BKR5EK	23
5962.Z0	BKR6EK	20
7267.52	BR6HSA	
7343.71	BR8HS	
7355.92	BPR6HS	3
7369.54	BR7HS	
7369.75	BR7ES	
7370.27	BPR5HS	
7381.55	BR8ES	
7423.80	CR7E	
7443.61	CPR8E	
7461.74	CR7EB	
7540.50	BR9ES	
7567.56	DPR7EA-9	
7567.57	B6HS	
7567.58	BP5HS	
7567.59	B7HS	
7567.60	B8HS	
7567.61	BP6HS	18
7567.62	B9ES	
7567.63	B9HS	
7567.66	B8ES	
7567.67	CPR8EB-9	
7567.68	BR9HS	
7567.70	B6ES	
7581.44	CR7HSA	
7598.74	CR7EKB	
7604.64	BPR7ES	19
7616.05	CR9EB	
7664.20	CR7EKA	
7682.28	CR8EKB	
7696.18	CR8EB	
11 737 027 00	BPR5HS	



PSA	→ NGK	V-Line
16 075 776 80	DILFR5A11	
95 496 692	BP6HS	18
95 605 398	B6HS	
95 611 941	BP6EFS	5
95 619 043	BP6ES	4
96 000 090	BCP5ES	16
96 037 952	BCP5ES	16
96 039 962	BCP6ET	
96 064 890	BKR5ES	35
96 097 486	BCP7ET	
96 145 071	BCPR6ET	
96 762 881 80	LZKR6AI-10G	
97 533 994	BP7EFS	
AM 212 207 A	B6HS	
MKP 00073	BP7ES	
V7 534 226 80	PLZKBR7A-G	
V7 534 226 80-03	PLZKBR7A-G	
V7 570 106 80	ILZKBR7A-8G	
ZC 986 209 0U	BP5ES	8
ZCT 000 011	BP6HS	18
ZCT 000 012	BP7ES	

RENAULT	→ NGK	V-Line
22 40 1EA 015	PLZKAR6A-11	
22 40 1JA 01B	DILKAR6A11	
74 39 146 775	BCPR5ET	
77 00 101 401	BKR5ES	35
77 00 103 502	BPR5ES	6
77 00 103 503	BPR5ES	6
77 00 103 533	BKR5EK	23
77 00 107 916	BKR5EK	23
77 00 115 827	BKR6EK	20
77 00 260 637	BCP7ET	
77 00 266 295	BPR6EFS	7
77 00 267 140	BPR6EFS	7
77 00 267 805	TR7IX	
77 00 273 462	BKR6ES	28
77 00 273 698	BKR6EIX	
77 00 500 168	BKR6E	28
77 00 553 622	BP6ES	4
77 00 565 155	BR9EIX	
77 00 587 168	BP6HS	18
77 00 714 540	BPR6EFS	7
77 00 722 095	BP6EFS	5
77 00 724 821	BP6ES	4
77 00 725 302	BPR5ES	6
77 00 726 503	BP7EFS	
77 00 727 383	BPR6ES	2
77 00 731 583	BP7EFS	
77 00 732 626	BP8ES	
77 00 733 422	BP5HS	

RENAULT	→ NGK	V-Line
77 00 736 149	BP7EFS	
77 00 736 150	BP7EFS	
77 00 737 457	BP7EFS	
77 00 737 458	BP6EFS	5
77 00 737 459	BP7ES	
77 00 737 612	BCP5ES	16
77 00 742 094	BPR7ES	19
77 00 743 137	BCP5ES	16
77 00 743 920	BP5ES	8
77 00 749 163	BCP5ES	16
77 00 824 821	BP6ES	4
77 00 852 522	BP6EFS	5
77 00 852 543	TR7IX	
77 00 855 463	BCP6ET	
77 00 855 918	BP5EFS	
77 00 856 342	BCP6ET	
77 00 859 910	BCP5ES	16
77 00 859 967	BP5ES	8
77 00 860 235	BP5ESZ	
77 00 861 471	BP7ES	
77 00 861 472	BP6ESZ	
77 00 862 054	BP5ES	8
77 00 868 864	BPR7ES	19
77 00 869 200	BK5ESZ	
77 00 871 617	BCPR6ET	
77 01 021 767	BP6EFS	5
77 01 041 021 4	BP5ES	8
77 01 041 214	BP5ES	8
77 01 041 215	BP6EFS	5
77 01 042 816	BKR6ES	28
77 01 043 624	BCPR6ET	
77 01 045 018	BP7EFS	
77 01 065 085	PLZKAR6A-11	
77 01 366 057	BP6HS	18
77 01 366 084	BR8EIX	
77 01 366 085	BR7EIX	
77 01 366 086	BP6ES	4
77 01 366 087	BP7ES	
77 01 366 137	BP6EFS	5
77 01 366 267	BP6HS	18
77 01 366 268	BP7ES	
77 01 366 269	BP6ES	4
77 01 366 270	BP6EFS	5
77 01 366 513	BP5HS	
77 01 366 514	BP6EFS	5
77 01 366 515	BP6HS	18
77 01 366 516	BP6ES	4
77 01 366 533	B6HS	
77 01 366 539	BP5ES	8
77 01 366 903	BP5ES	8
77 01 414 022	BP5HS	
77 01 414 025	BP6ES	4





RENAULT	→ NGK	V-Line
77 01 414 026	BP7EFS	
77 01 414 027	BP7EFS	
77 01 414 031	BPR6ES	2
77 01 414 105	BP5ESZ	
82 00 020 791	BKR6EZ	38
82 00 027 363	BKR5EK	23
82 00 030 765	LZKAR7A	
82 00 046 337	PFR6G-9	
82 00 239 321	PFR6E-10	
82 00 314 928	PFR7G-9	
82 00 322 273	LZKAR7A	
82 00 363 364	PFR6G-9	
82 00 363 384	PFR6G-9	
82 00 492 426	PFR7Z-TG	
82 00 587 901	ILKAR7A7	
82 00 592 215	LZKAR7B	
82 00 662 185	LZKAR7B	
83 04 504 277	ZFR5F	
88 03 343 3	IGR7E-3D	
89 33 003 862	BKR6ES	28
96 26 575 480	BKR6EK	20
96 32 182 880	PFR6E-10	

ROLLS-ROYCE	→ NGK	V-Line
RH12 050	GR4IX	
RH13 439	BKR4EVX	
RH13 998	BKR5EIX	

ROVER	→ NGK	V-Line
NLP 100 260	BPR6E	2
NLP 100 290	PFR6N-11	

SAAB	→ NGK	V-Line
12 14 060	PFR6D10G	
12 14 065	DILFR7B10G	
45 71 808	PFR7H-10	
48 11 581	ILTR5D	
56 92 485	BCP7EVX	
59 58 780	BCP5EVX	
59 58 798	BCP6EVX	
59 62 485	BCP7EVX	
88 19 294	BCP6ES	17
88 19 302	BCP7EVX	
88 19 328	BPR7EIX	
91 12 541	BCPR7ES-11	
91 16 385	BCP5ES	16
91 17 565	BCPR6ES-11	11
91 36 276	BCP5EVX	
91 39 643	BCP6EVX	
91 71 307	BKR7ES-11	
91 85 398	PFR7H-10	

SAAB	→ NGK	V-Line
91 88 681	PFR7H-10	
91 95 109	BKR5EK	23
91 95 868	BKR5EQUA	
93 99 866	PFR6H-10	
12 620 540	ILTR5D	
12 787 099	PFR6T-10G	
12 788 884	PLFR6C-10G	
15 885 210	BCPR7ES-11	
30 520 467	BCPR6ES-11	11
32 000 330	BCPR7ES-11	
55 564 215	BKR7ESC-11	
55 564 748	DILFR7B10G	
55 564 763	ZFR6BP-G	
55 571 391	PFR6D10G	
5 958 780	BCP5EVX	
83 500 768	BCP7ES	

#### SEAT => VW Group

#### SKODA => VW Group

#### SMART => MERCEDES

#### STEYR => MERCEDES

SUBARU	→ NGK	V-Line
065-01408-60	CR5HSB	
22401-AA000	BP5ES-11	
22401-AA010	BP6ES-11	
22401-AA020	BP6ES	4
22401-AA030	BP6ES	4
22401-AA080	BP6EY	
22401-AA090	BP7ES	
22401-AA100	BE527Y-11	
22401-AA110	BE527Y-11	
22401-AA120	BPR6ES-11	13
22401-AA130	BPR6ES-11	13
22401-AA200	BPR6ES	2
22401-AA210	BPR7ES	19
22401-AA220	BPR6ES	2
22401-AA230	BPR7E	19
22401-AA310	BKR6E-11	14
22401-AA320	BKR6E-11	14
22401-AA360	PFR7B	
22401-AA370	PFR6B-11	
22401-AA380	BRE527Y-11	
22401-AA390	BRE527Y-11	
22401-AA400	PFR6B	
22401-AA460	BPR5EY-11	
22401-AA470	BPR6EY-11	10
22401-AA480	BPR5ES-11	
22401-AA500	BKR6EIX-11	



SUBARU	→ NGK	V-Line
22401-AA510	BKR6EIX	
22401-AA520	PFR6G-11	
22401-AA530	PFR6G	
22401-AA531	PFR6G	
22401-AA570	PFR5B-11	
22401-AA580	PLFR6A-11	
22401-AA600	PFR7G	
22401-AA610	ZFR6FIX-11	
22401-AA630	ILFR6B	
22401-AA650	FR5AP-11	
22401-AA65A	FR5AP-11	
22401-AA670	SILFR6A	
22401-AA680	ILFR6B	
22401-AA700	DILFR6D11	
22401-AA720	SILFR6A11	
22401-AA730	SIFR6A11	
22401-AA750	SILFR6C11	
22401-KA000	BUR6EA-11	
22401-KA010	BKR6E-11	14
22401-KA030	BKR6E-11	14
22401-KA050	BUR6EA-11	
22401-KA060	BUR6EA-11	
22401-KA080	BKR6E	28
22401-KA090	BCPR6E	12
22401-KA100	BCPR6E	12
22401-KA130	BPR6ES	2
22401-KA140	ZFR6G	
22401-KA150	BKR6E	28
22401-KA160	ZFR6G	
22401-KA170	ZFR5G	
22401-KA180	ZFR5G	
22401-KA190	BPR5E-11	
22401-KA200	BKR5E-11	33
22401-KA210	BKR5E-11	33
22401-KA240	DCPR7E	
22401-KA260	DCPR7E	
22401-KA290	BKR4E-11	
22401-KA310	DCPR8E	
22401-KA320	DCPR8EIX	
22401-KA340	KR8BI	
22401-KA430	BKR6EKPA	
22401-KA440	BKR5E	35
22401-KA450	LKR7AI	
32054-0800	B6ES	
32054-1110	B7ES	
32054-1120	BR7EIX	
32054-1320	B6EVX	
32054-5700	BR6ES	
38028-0102	BP6EY	
38242-0800	B5ES	
42054-3200	BP5ES	8
42054-5502	BP6ES	4

SUBARU	→ NGK	V-Line
42054-5602	BP5EY-11	
42054-5702	BP6ES-11	
42054-5800	BE529Y-11	
42054-5802	BE529Y-11	
42054-7102	BP5EY	
42054-7302	BP5EY-11	
48028-7100	BP4EY-11	
49001-0003	BPR5EIX	
49001-0013	BPR6EIX	
49001-0023	BPR7EIX	
49001-0033	BPR5ES	6
49001-0043	BP5EY	
49001-0053	BP6EY	
49001-0082	BPR5EY	9
49001-0092	BPR6EY	
82054-1810	B6HS	
82054-1812	B6HS	
82054-6010	B8HS	
82054-7820	BR6HIX	
82054-8020	BR8HIX	
82054-8600	B6ES	
82054-9310	B7HS	
82054-9312	B7HS	
82054-9320	BR7HIX	
88241-7800	B5HS	
89057-3400	B6S	
SAB 330 DE 0710	BKR5EIX-11P	
SAB 330 DE 0720	BKR6EIX-11P	
SAB 330 DE 0730	BKR7EIX-P	
SAB 330 DE 0800	DCPR7EIX-P	
SAB 330 DE 2640	LFR6AIX-11	
SAB 330 DE 2670	LFR6AIX-11P	
SAB 330 DE 2680	LFR7AIX-P	
SAB 330 DE 2800	BKR6EIX-P	
SAB 330 DE 3360	BKR5EIX-11	
SAB 330 DE 3370	BKR6EIX-11	
SAB 330 DE 3430	DCPR7EIX	
SAB 330 DE 3450	IRIWAY7	
SAB 330 DE 3710	BKR5EIX-11P	
SAB 330 DE 3720	BKR6EIX-11P	
SAB 330 DE 3730	BKR7EIX-P	
SAB 330 DE 3800	DCPR7EIX-P	
SAB 330 DE 3950	BKR6EIX-P	
SAB 330 DE 4540	LFR6AIX-P	
SAB 330 DE 5140	LFR6AIX-11	
SAB 330 DE 5150	LFR6AIX-11P	
SAB 330 DE 5170	LFR7AIX-P	
SAB 330 DE 5260	LFR6AIX-P	
SAB 330 DE 5270	LFR7AIX-P	
SAB 330 DE 8430	IRIWAY7	
SAB 330 DE 8640	IFR5E11	
SAB 330 DE 8680	BKR5EIX-11	



SUBARU	→ NGK	V-Line
SAB 330 DE 8690	BKR6EIX-11	
SAB 330 DE 8720	DCPR7EIX	
SUZUKI	→ NGK	V-Line
09482-00006	B-4	
09482-00011	B-4H	
09482-00036	BP-4H	
09482-00051	B6S	
09482-00053	B7S	
09482-00054	B6ES	
09482-00056	B8ES	
09482-00059	BP6HS	18
09482-00060	BP7HS	
09482-00064	BR6HIX	
09482-00065	BR7HIX	
09482-00066	B9ES	
09482-00074	BP6HS	18
09482-00079	BR6ES	
09482-00082	B7HS	
09482-00083	B7HS	
09482-00084	BP6HS	18
09482-00088	BR6HS	
09482-00089	B7ES	
09482-00091	B8ES	
09482-00095	B6HS	
09482-00096	BR8EIX	
09482-00097	BR9EIX	
09482-00098	BR9ES	
09482-00102	BR8HS	
09482-00105	BP7HS	
09482-00114	BR8EIX	
09482-00115	BR9EIX	
09482-00116	BR7HS	
09482-00117	BR7ES	
09482-00118	BP6ES	4
09482-00120	BP5HS	
09482-00121	BR8ES	
09482-00123	BP5EY	
09482-00124	BP5HS	
09482-00125	BPR-4H	
09482-00127	BR9ES	
09482-00128	B6ES	
09482-00129	BP4EY	
09482-00130	BP4EY	
09482-00131	BP5ES	8
09482-00136	BPR-4H	
09482-00139	BP7ES	
09482-00141	BPR6HS	3
09482-00142	B-4H	
09482-00143	BR5HS	
09482-00144	D8EA	
09482-00145	D8EA	

SUZUKI	→ NGK	V-Line
09482-00147	BPR5HS	
09482-00149	DR8ES-L	
09482-00151	B8HS	
09482-00153	B7HS	
09482-00155	BPR5ES	6
09482-00157	BR8HS	
09482-00159	BPR4EY	
09482-00161	BP4HS	
09482-00163	BP5HA	
09482-00167-000	BPR5EY	9
09482-00167-001	BPR5ES	6
09482-00170	BP4HA	
09482-00171	BP4HS	
09482-00172	BP2HS	
09482-00175	BP8ES	
09482-00177	BP6ES	4
09482-00181	BR10EIX	
09482-00182	D7EA	
09482-00183	D7EA	
09482-00184	D9EA	
09482-00185	D9EA	
09482-00186	BP-4H	
09482-00188	BP6HS	18
09482-00189	BP7HS	
09482-00190	B6HS	
09482-00191	B7HS	
09482-00192	B8HS	
09482-00195	B7ES	
09482-00196	B8ES	
09482-00198	B8HS	
09482-00205	BPR4HS	
09482-00206	BPR4HS	
09482-00208	B8EGV	
09482-00209	B9EGV	
09482-00210	B10EGV	
09482-00216	BP4EY-11	
09482-00217	BP5EY-11	
09482-00218	BP4EY-11	
09482-00219	BP5EY-11	
09482-00220	DR7ES	
09482-00221	DR8ES	
09482-00222	DR7EA	
09482-00223	DR8EA	
09482-00225	B8ES	
09482-00226	BP7ES	
09482-00227	CM-6	
09482-00228	BP5HS	
09482-00229	BPR6HS	3
09482-00230	BR8HS	
09482-00233-111	BR9ES	
09482-00234	DR9EA	
09482-00237	B8HS	



SUZUKI	→ NGK	V-Line
09482-00239	BPR8ES	
09482-00240-111	BPR8ES	
09482-00244-111	BPR7HS	
09482-00247-111	BR8ES	
09482-00255	BPR7HS	
09482-00258	BPMR6A	
09482-00259	BP6HS	18
09482-00260	BPM4A	
09482-00261	BPMR4A	
09482-00262	BP5HS-10	
09482-00263	BP5HS-10	
09482-00264	BP6HS-10	
09482-00265	BP6HS-10	
09482-00268	BP8HS	
09482-00269	B7HS-10	
09482-00277	BR7HS-10	
09482-00278	B8HS-10	
09482-00279	B8HS-10	
09482-00280	BR8HS-10	
09482-00281	BPR6HS	3
09482-00282	B5HS	
09482-00284	BP6EY-11	
09482-00285	BPR6ES-11	13
09482-00286	BPR6EY-11	10
09482-00287	BP5ES-11	
09482-00288	BP4ES	
09482-00289	B-4H	
09482-00290	BP-4H	
09482-00291	BP4HS	
09482-00294	C6HA	
09482-00295	C6HSA	
09482-00299	BPR6ES	2
09482-00302-111	BPR6HS	3
09482-00303	BP6EY-11	
09482-00305	BP5HS	
09482-00306	BPR6HS	3
09482-00308	BR5HS	
09482-00309	B5HS	
09482-00312	BPR5EY-11	
09482-00314	CR7HSA	
09482-00316	BPR5HS	
09482-00317	C8HA	
09482-00320-111	CR8HSA	
09482-00321	C8HSA	
09482-00322	BPR5EIX	
09482-00325	BR8EIX	
09482-00327	BR6HS-10	
09482-00328	DP9EA-9	
09482-00330	DPR9EA-9	
09482-00331-111	DPR7EA-9	
09482-00332	DP8EA-9	
09482-00333-111	DP8EA-9	

SUZUKI	→ NGK	V-Line
09482-00334	DPR8EA-9	
09482-00335-111	DPR7EA-9	
09482-00338	B6HS-10	
09482-00339	B6HS-10	
09482-00340	CR6HS	
09482-00341	BR6HS-10	
09482-00348	BR8ES	
09482-00349	BR9ES	
09482-00351	B9ES	
09482-00352	DP7EA-9	
09482-00354	DPR7EA-9	
09482-00355-111	DPR7EA-9	
09482-00358	BR4HS	
09482-00359	BPR5HS	
09482-00360	BR10ES	
09482-00362	ZGR5A	15
09482-00363	BPR5EY	9
09482-00365	J9A	
09482-00366	JR9B	
09482-00367	BPR4HS	
09482-00368	DCP7E	
09482-00369	DCP7E	
09482-00370	BR8HS-10	
09482-00371	J10A	
09482-00372	JR10B	
09482-00375	B8HS-10	
09482-00376	B8HS	
09482-00378	DCPR8E	
09482-00379	DCPR8E	
09482-00381	PJR7A	
09482-00383	DCPR8EIX	
09482-00384	DCPR8EIX	
09482-00385	BP7ES	
09482-00386	DCPR7EIX	
09482-00387	DCPR7EIX	
09482-00388	JR9B	
09482-00389	JR9B	
09482-00390	JR10B	
09482-00391	JR10B	
09482-00392	BP6ES	4
09482-00393	DCP6E	
09482-00394	DCP6E	
09482-00395	ZG5E	
09482-00397	JR9C	
09482-00398	DR7EA	
09482-00399	DR8EA	
09482-00400	DR9EA	
09482-00401	JR8C	
09482-00404	LR8A	
09482-00406	C6HSA	
09482-00407	CR6HSA	
09482-00408	CR7HSA	



SUZUKI	→ NGK	V-Line
09482-00409	BPR6ES	2
09482-00410	CR9EK	
09482-00411	CR9EK	
09482-00412	CR8EK	
09482-00413	CR8EK	
09482-00414	CR7EK	
09482-00416-111	BPR5HS	
09482-00419	R2525-11	
09482-00420-111	BPR-4H	
09482-00421	BPR6ES-11	13
09482-00422	R5184-95	
09482-00423	R5184-10	
09482-00424	R5184-105	
09482-00426	BK6E	
09482-00427	BKR6E	28
09482-00429	BKR6E	28
09482-00430	R0373A-10	
09482-00431	R0373A-11	
09482-00432	BPR5E	6
09482-00433	BPR5EY-11	
09482-00434	BP7ES	
09482-00446	DCPR6E	
09482-00447	DCPR6E	
09482-00448	DCPR7E	
09482-00449	DCPR7E	
09482-00450	DCPR8E	
09482-00452	ZGR5A	15
09482-00456	CR8E	
09482-00457	CR8E	
09482-00458	CR9E	
09482-00459	CR9E	
09482-00460	CR10E	
09482-00461	CR10E	
09482-00462	CR10EK	
09482-00463	CR10EK	
09482-00464	BR8HCS-10	
09482-00467	BR9HS-10	
09482-00468	BPR5E	6
09482-00470	BR8ECM	
09482-00472	BR9ECM	
09482-00473	BR9ECM	
09482-00474	BR10ECM	
09482-00476	BKR5E	35
09482-00477	BKR5E	35
09482-00478	B10ES	
09482-00479	DCPR7EIX	
09482-00481	DCPR8EIX	
09482-00482	DCPR7EIX	
09482-00484	DCPR8EIX	
09482-00485	CR8HSA	
09482-00486	BR8HCS-10	
09482-00487	BPR6ES	2

SUZUKI	→ NGK	V-Line
09482-00488	DCPR7E	
09482-00491	JR8B	
09482-00493	BPR5E-11	
09482-00494	BKR6E-11	14
09482-00495	BPR7ES	19
09482-00496	BPR5E-11	
09482-00497	BKR5E-11	33
09482-00498	BPR7ES	19
09482-00499	R4118S-8	
09482-00500	R4118S-9	
09482-00501	BPR6EY	
09482-00502	BP5EY	
09482-00504	BPR5EY	9
09482-00508	BKR6E-11	14
09482-00509	R6918B-8	
09482-00511	R6918B-7	
09482-00513	R0045J-10	
09482-00514	R0045J-11	
09482-00515	CR7E	
09482-00516	CR7E	
09482-00519	BR9EYA	
09482-00521	PGR5A	
09482-00522	BPR7HS-10	
09482-00523	BPR8HS	
09482-00525	IKR7A	
09482-00526	BR10EYA	
09482-00527	KR7AI	
09482-00528	CR6E	
09482-00530	BPR6HS	3
09482-00531	BP6HS	18
09482-00532	B7HS-10	
09482-00533	BR7HS-10	
09482-00534	B6HS-10	
09482-00535	BR6HS-10	
09482-00537	DCPR9EIX	
09482-00540	PFR5G-11	
09482-00546	GR5AI-10	
09482-00547	IFR5E11	
09482-00548	IFR6E11	
09482-00549	IFR5J11	
09482-00550	IFR6J11	
09482-00557	CR9EIA-9	
09482-00558	CR9EIA-9	
09482-00561	BR8EG	
09482-00562	IFR5E11	
09482-00564	BR9EYA	
09482-00565	KR8AI	
09482-00566	BKR5E-11	33
09482-00570	CR8EB	
09482-00581	CR8EKB	
09482-00582	CR9EKB	
09482-00584	CR8EIB-10	







TORCH	→ NGK	V-Line
A 6 RTC	CR6HSA	
A 6 TC	C6HSA	
A 7 RTC	CR7HSA	
A 7 T	C7HSA	
A 7 TC	C7HSA	
A 8 RTC	CR8HSA	
A 8 TC	C8HSA	
B 8 RC	CR8E	
C 6 RTC	D6HA	
CMR 7 H	CMR7H	
D 6 RTC 9	DPR6EA-9	
D 7	D7EA	
D 7 CA	D7EA	
D 7 RC	D7EA	
D 7 RTC	DPR7EA-9	
D 7 RTC 9	DPR7EA-9	
D 7 TC	DP7EA-9	
D 8 C	D8EA	
D 8 RC	DR8EA	
D 8 RTC	DR8EA	
D 8 T	D8EA	
DK 7 RTC	DCPR7E	
E 4 RTC	BPR4HS	
E 4 TC	BP4HS	
E 5 RTC	BPR5HS	
E 5 T	BP-4H	
E 5 TC	BP5HS	
E 6 RC	BR6HS	
E 6 RTC	BPR6HS	3
E 6 T	BP4HS	
E 7 C	B6HS	
E 7 TJC	BUR6ET	1
E 8 RC	BR8HS	
E 8 RTC	BPR8HS	
F 5 C	B4ES	
F 5 RF	BPR5EY	9
F 5 RTC	BPR5ES	6
F 5 T	BP4ES	
F 5 TC	BP5ES	8
F 6 RF	BPR6EY	
F 6 RTC	BPR6ES	2
F 6 T	BP6ES	4
F 7 C	B7ES	
F 7 RC	BR7ES	
F 7 RTC	BPR7ES	19
F 7 RTJC	BUR6ET	1
F 8 RC	BR8ES	
F 8 RTC	BP8ES	
G 3 F	B-4	
G 3 TC	BP-4	
G 4 C	B-4	
G 4 RC	B-4	

TORCH	→ NGK	V-Line
G 5 RC	BR6S	
G 6	B6S	
G 6 C	B6S	
G 6 RC	BR6S	
GL 4	B4-LM	
H 5	B6S	
K 4 RTC 3	ZFR5F	
K 5 RF 11	BKR5E-11	33
K 5 RTC 11	BKR5ES-11	33
K 5 RTS	ZFR5P-G	
K 5 TC	BKR5ES-11	33
K 6 RF	BKR6ES	28
K 6 RF 11	BKR6E-11	14
K 6 RTC	BKR5E-11	33
K 6 RTC 11	BKR6ES-11	14
K 7 RTC	BKR6ES	28
K 7 TC	BCP6ES	17
K 7 TJC	BCP6ET	
L 5 C	BM4A	
L 5 T	BPM4A	
L 6	BM6A	
L 6 C	BM6A	
L 6 RC	BMR6A	
L 6 RTC	BPMR6A	
L 6 T	BPM6A	
L 6 TC	BPM6A	
L 7	BM7A	
L 7 RTC	BPMR7A	
L 7 T	BPM7A	
L 7 TC	BPM7A	
L 7 Y	BM7A	
L 8 RT	BPMR7A	
L 9	BM7A	
L 9 T	BPM7A	
N 6	BM6F	
N 6 C	BM6F	
N 6 RC	BMR6F	
N 6 RTC	BPMR6F	
N 6 TC	BPM6F	
N 7 C	BM7F	
N 7 RC	BM7F	
N 9	BM7F	
P 5 RTC	BPR5FS	
P 5 TC	BP5FS	
P 6 RTC	BPR6FS	
P 6 TC	BP6FS	
P 7 RTC	BP7FS	
P 7 TC	BP7FS	
Q 5 RTC	BPR5EFS	
Q 5 TC	BP5EFS	
Q 6 RTC	BPR6EFS	7
Q 6 TC	BP6EFS	5



<b>TORCH</b>	<b>→ NGK</b>	<b>V-Line</b>
Q 7 TC	BP5EFS	
R 4 C	AB-6	
T 5 TC	AP5FS	
T 6 RTC	APR6FS	
T 6 TC	AP6FS	
T 1137 C	C7HSA	
<b>TOYOTA</b>	<b>→ NGK</b>	<b>V-Line</b>
04195-34140	BP5ES	8
04195-34150	BP6ES	4
04195-34280	BPR5EY	9
04195-34320	BPR5EY-11	
08922-01016-83	BPR5EY	9
08922-01017-83	BPR6EY-11	10
08922-01019-83	BPR5EY-11	
08922-01020-83	BCPR6EY-11	
90048-51054	BPR5EY	9
90048-51059	BPR6EY	
90048-51063	BPR5EY-11	
90048-51093-A	BPR5EY-11	
90048-51108-1	BPR6EKB-L	
90048-51126	BPR5EJ	
90048-51131	BPR5EKB	
90048-51131-1	BPR5EKB	
90048-51134	BCPR6EKD	
90048-51134-1	BCPR6EKD	
90048-51140	BPR6EKB	
90048-51158	BKR5E-11	33
90048-51187	IKR7C	
90080-91116	BKR6EKP-11	
90098-00835	BUHX	
90098-00845	BUHW	
90098-00855	BUHW-2	
90098-09026	AB-2	
90098-09036	B-2	
90098-09115	BP-2H	
90098-09125	BP-2E	
90098-09685	BP2HS	
90098-09775	BP-4	
90098-09815	BP-4	
90098-14055	B4ES	
90098-14395	BP4EY	
90098-14425	BPR4EY	
90098-14515	BP-4H	
90098-14545	BPR4ES-13	
90098-14595	BP4EY	
90098-14615	BP4EY-11	
90098-14645	B-4H	
90098-14665	BPR4EY-11	
90098-14685	BP4HS	
90098-14715	B-4	
90098-14775	BP-4	

<b>TOYOTA</b>	<b>→ NGK</b>	<b>V-Line</b>
90098-14785	BPR4FS	
90098-14805	BPR4FS-15	
90098-14815	BP-4	
90098-16145	AP5FS	
90098-16325	BPR5ES	6
90098-16395	BP5EY	
90098-16415	C5HSA	
90098-16425	BPR5EY	9
90098-16455	B5ES	
90098-16505	B5ES	
90098-16515	BP5HS	
90098-16545	BP5ES-13	
90098-16595	BP5EY	
90098-16615	BP5EY-11	
90098-16635	BP5EFS	
90098-16645	B5ES	
90098-16655	BUR5EB-11	
90098-16675	BPR5EY	9
90098-16695	BP5EY	
90098-16705	BP5FS	
90098-16735	APR5FS	
90098-16745	BPR5E	6
90098-16775	BP5S	
90098-16785	BPR5FS	
90098-16795	BPR5FS-11	
90098-16805	BPR5FS-15	
90098-16815	BP5S	
90098-16865	BR5FS	
90098-16875	YR55IX	
90098-16895	BPR6EFS	7
90098-16925	BP5HS-10	
90098-16935	BR5ES	
90098-16955	BE527Y-11	
90098-16975	BUR5EB-11	
90098-16985	BCPR5EY-11	
90098-17015	AB-6	
90098-17025	AB-6	
90098-20145	AP6FS	
90098-20276	B6S	
90098-20325	BPR6ES	2
90098-20355	BM6A	
90098-20395	BP6EY	
90098-20415	C6HSA	
90098-20425	BPR6EY	
90098-20455	B6ES	
90098-20465	D6EA	
90098-20485	D6HA	
90098-20495	DR6HS	
90098-20505	B6ES	
90098-20515	BP6HS	18
90098-20525	BP6HSA	
90098-20545	BPR6EIX-11	



TOYOTA	→ NGK	V-Line
90098-20595	BP6EY	
90098-20615	BP6EY-11	
90098-20625	BPR6EK-A	
90098-20635	BP6EFS	5
90098-20645	B6HS	
90098-20655	BUR6EB-11	
90098-20665	BPR6EY-11	10
90098-20675	BPR6EY	
90098-20695	BP6ES	4
90098-20705	BP6FS	
90098-20735	APR6FS	
90098-20745	BPR6ES	2
90098-20755	BUR6EA-11	
90098-20765	C6HSA	
90098-20775	BP6S	
90098-20785	BPR6FS	
90098-20865	BR6FS	
90098-20885	BP6EFS	5
90098-20895	BPR6EFS	7
90098-20905	BR6ES	
90098-20915	BUR6EB-11	
90098-20925	BP6HS-10	
90098-20935	BR6ES	
90098-20975	BUR6EB-11	
90098-20985	BCPR6EY-11	
90098-21655	BR6EB-L-11	
90098-21915	BR6EB-L-11	
90098-22015	AB-7	
90098-22025	AB-7	
90098-22276	B7S	
90098-22325	BPR7ES	19
90098-22355	BM7A	
90098-22415	C7HSA	
90098-22455	B7ES	
90098-22465	D7EA	
90098-22475	DR7EA	
90098-22505	B7ES	
90098-22515	BP7HS	
90098-22595	BP7EY	
90098-22645	B7HS	
90098-22655	BUR7EB-11	
90098-22745	BPR7ES	19
90098-22755	BUR7EA-11	
90098-22765	C7HSA	
90098-22885	BP7EFS	
90098-22905	BR7ES	
90098-22915	BUR7EB-11	
90098-22935	BR7ES	
90098-22975	BUR7EB-11	
90098-24125	BP8ES	
90098-24276	B8S	
90098-24465	D8EA	

TOYOTA	→ NGK	V-Line
90098-24475	DR8EA	
90098-24485	D8HA	
90098-24495	DR8HS	
90098-24505	B8ES	
90098-24645	B8HS	
90098-24695	BP8ES	
90098-24935	BR8ES	
90098-25305	B8EG	
90098-25375	BR8HIX	
90098-27305	B9EG	
90098-27465	D9EA	
90098-27475	DR9EA	
90098-27505	B9ES	
90098-27645	B9HS	
90098-27935	BR9ES	
90098-31305	B10EG	
90098-31465	D10EA	
90098-31505	B10ES	
90098-33034	BCPR5EY-11	
90098-34305	B11EG	
90098-64017	B4-LM	
90098-64018	B-4L	
90098-64032	GR4IX	
90098-64033	GR4IX	
90098-64050	BPR4ES-13	
90098-64065	ZFR4F-11	
90098-64066	ZFR4F-11	
90098-64112	BUR4EB-11	
90098-66001	BP5EY-11	
90098-66004	BPR5E-11	
90098-66005	BCPR5EY-11	
90098-66006	BUR5EB-11	
90098-66007	BP5EY-11	
90098-66011	DR5HS	
90098-66016	B-6L	
90098-66024	BR5HS	
90098-66031	BPR5EY-11	
90098-66032	BPR5EIX	
90098-66033	BPR5EIX	
90098-66038	BCPR5EIX-11	
90098-66039	BCPR5EIX-11	
90098-66040	BCPR5EY-11	
90098-66045	BCPR5EIX-11	
90098-66047	BKR5E-11	33
90098-66050	BPR5ES-13	
90098-66053	BKR5E	35
90098-66054	BKR5EIX-11	
90098-66056	BKR5EYA-11	39
90098-66058	BPR5E	6
90098-66059	BKR5E-N-11	
90098-66064	PFR5J-11	
90098-66065	ZFR5J-11	



TOYOTA	→ NGK	V-Line
90098-66066	ZFR5F-11	
90098-66069	BPR5EKB	
90098-66070	PFR5B-11	
90098-66071	BKR5EYA	
90098-66075	ZFR5E-11	
90098-66077	BKR5EIX-11	
90098-66080	PZFR5F-11	
90098-66081	PZFR5F	
90098-66082	BCPR5E	32
90098-66108	PGR5A-11	
90098-66109	BPR5EJ	
90098-66113	PTR5C-13	
90098-66114	BKR5EIX-11	
90098-66115	BCPR5EIX-11	
90098-66116	BPR5EIX-11	
90098-70001	BP6ES-11	
90098-70002	BUR6EA-11	
90098-70003	BPR6ES-11	13
90098-70004	BPR6ES-11	13
90098-70005	BKR6E-11	14
90098-70007	BP6ES-11	
90098-70008	BPR6EFS-15	
90098-70023	CR6HSA	
90098-70024	BR6HS	
90098-70025	BR6S	
90098-70026	BP6S	
90098-70027	AR6FS	
90098-70030	BPM6A	
90098-70031	BPR6EY-11	10
90098-70032	BPR6EIX	
90098-70033	BPR6EIX	
90098-70034	BCPR6EY-11	
90098-70036	B6EVX	
90098-70038	BCPR6EIX-11	
90098-70039	BCPR6EIX-11	
90098-70040	BKR6E-11	14
90098-70041	ZFR6A-11	
90098-70043	BP6ES	4
90098-70044	ZFR6A-11	
90098-70046	BCPR6EIX-11	
90098-70047	BKR6E-11	14
90098-70048	BPR6EKN	
90098-70049	BPR6EKB-L	
90098-70050	BPR6EIX-11	
90098-70051	DCPR6E	
90098-70053	BKR6E	28
90098-70054	BKR6EIX-11	
90098-70055	BPR6EFS-15	
90098-70056	BKR6EYA-11	
90098-70058	BPR6ES	2
90098-70059	BKR6E-N-11	
90098-70060	PFR6G-11	

TOYOTA	→ NGK	V-Line
90098-70064	PFR6J-11	
90098-70065	ZFR6J-11	
90098-70066	ZFR6F-11	
90098-70067	BCPR6EKD	
90098-70069	BPR6EKB	
90098-70070	PFR6B-11	
90098-70071	BKR6EYA	
90098-70074	ZFR6G	
90098-70077	BKR6EIX-11	
90098-70080	PZFR6F-11	
90098-70081	PZFR6F	
90098-70082	BCPR6E	12
90098-70085	BUR6ET	1
90098-70086	PFR6J	
90098-70105	BPR6EKN	
90098-70106	BPR6HS-10	
90098-70108	PGR6A-11	
90098-70114	BKR6EIX-11	
90098-70115	BCPR6EIX-11	
90098-70116	BPR6EIX-11	
90098-72019	DPR7Z	
90098-72021	DPR7EA-9	
90098-72023	CR7HSA	
90098-72024	BR7HS	
90098-72030	BPM7A	
90098-72036	BR7EIX	
90098-72037	DR7EIX	
90098-72042	DCP7E	
90098-72047	BKR7E-11	
90098-72051	DCPR7E	
90098-72052	DCPR7EIX	
90098-72067	BCPR7EKD	
90098-72068	BCPR6ED	
90098-72070	PFR7B-11	
90098-72078	BK7EK-N-11	
90098-72114	IRIWAY7	
90098-72115	IRITOP7	
90098-72116	BPR7EIX	
90098-74013	B8EG	
90098-74014	B8HS-10	
90098-74019	DP8Z	
90098-74021	DPR7EA-9	
90098-74024	BR8HS	
90098-74036	BR8EIX	
90098-74037	DR8EIX	
90098-74042	DP8EA-9	
90098-74051	DCPR8E	
90098-74052	DCPR8EIX	
90098-77013	B9EG	
90098-77014	B9HS-10	
90098-77019	DPR9Z	
90098-77021	DPR7EA-9	





TOYOTA	→ NGK	V-Line
90098-77024	BR9HS	
90098-77036	BR9EIX	
90098-77037	DR9EIX	
90098-77063	BR9HS-10	
90098-77088	C9E	
90098-77102	JR9B	
90098-77111	CR9EHIX-9	
90098-79036	BR10EIX	
90098-79037	DR9EIX	
90098-81036	BR10EIX	
90098-81089	CR10EK	
90098-99201	BCPR6EP-11	
90098-99202	BCPR5EIX-11	
90098-99203	BPR5EP-11	
90098-99204	BCPR6EP-N-8	
90098-99205	BKR6EP-11	
90098-99206	BKR6EP-N-8	
90098-99207	BKR5EP-11	
90098-99208	BKR6EKP-11	
90919-01051	BPR5ES	6
90919-01055	BP-2E	
90919-01056	BP4EY	
90919-01059	BP5EY	
90919-01061	BP5EY	
90919-01063	BPR6EK-A	
90919-01064	BPR5EY	9
90919-01065	BPR5EY	9
90919-01073	B5ES	
90919-01083	BP6EY	
90919-01084	BPR6EY	
90919-01085	BP4EY-11	
90919-01087	BP5EK-A	
90919-01088	BPR6EK-A	
90919-01089	BPR6EK-A	
90919-01091	BPR5EY	9
90919-01092	BPR6EK-A	
90919-01094	BP5EY-11	
90919-01095	BPR5EIX-11	
90919-01096	BPR5EIX-11	
90919-01097	BPR6EK-A	
90919-01098	BPR6EY	
90919-01099	BP4EY	
90919-01100	BP5EFS	
90919-01101	BP5EY	
90919-01102	BPR5EY	9
90919-01103	BPR4EY	
90919-01104	BPR5EY-11	
90919-01108	BPR4EY-11	
90919-01109	BPR4EY-11	
90919-01113	BRE527Y-11	
90919-01114	BRE527Y-11	
90919-01115	BPR5EP-11	

TOYOTA	→ NGK	V-Line
90919-01116	BPR5EP-11	
90919-01117	BE529Y-11	
90919-01118	BE529Y-11	
90919-01119	BRE529Y	
90919-01120	BRE529Y	
90919-01121	BCPR5EIX-11	
90919-01122	BCPR5EIX-11	
90919-01123	BRE529Y-11	
90919-01125	BPR6EY-11	10
90919-01126	BPR6EY-11	10
90919-01127	BCPR6EP-11	
90919-01128	BCPR6EP-11	
90919-01129	BCPR5EY-11	
90919-01130	BCPR5EY-11	
90919-01131	BCPR6EY-11	
90919-01132	BCPR6EY-11	
90919-01133	BPR5EP-11	
90919-01134	BPR5EP-11	
90919-01135	BCPR6EIX-11	
90919-01136	BCPR6EIX-11	
90919-01138	BP6EY	
90919-01139	BP6EY-11	
90919-01143	BPR5EP-11	
90919-01144	BPR5EP-11	
90919-01145	BCPR6EP-N-8	
90919-01146	BCPR6EP-N-8	
90919-01147	BPR6EP-8	
90919-01148	BPR6EP-8	
90919-01149	BCPR6EY	
90919-01150	BCPR6EY	
90919-01151	BCPR5EP-8	
90919-01152	BCPR5EP-8	
90919-01153	BCPR5EY-11	
90919-01154	BCPR5EY	
90919-01155	BCRE527Y	
90919-01156	BCRE527Y	
90919-01157	BCPR6EIX-11	
90919-01158	BCPR5EIX-11	
90919-01159	BCPR5EY-11	
90919-01162	BCPR6EP-8	
90919-01164	BKR5EYA-11	39
90919-01165	BKR5EYA-11	39
90919-01166	BKR6EYA-11	
90919-01167	BKR6EYA	
90919-01168	BKR5EP-11	
90919-01169	BKR5EP-11	
90919-01170	BCPR4EY-11	
90919-01172	BKR6EP-N-8	
90919-01173	BKR6EP-N-8	
90919-01176	BKR5EYA	
90919-01177	BKR5EYA	
90919-01178	BKR6EP-11	



TOYOTA	→ NGK	V-Line
90919-01179	BKR6EP-11	
90919-01180	BKR6EP-8	
90919-01181	BKR6EP-8	
90919-01182	BCPR6EIX-11	
90919-01184	BKR6EY-11	
90919-01185	BKR6EYA-11	
90919-01187	BKR6EP-13	
90919-01188	BKR6EP-13	
90919-01191	ILFR6T11	
90919-01192	BKR5EKB-11	
90919-01193	BKR5EKB-11	
90919-01194	BKR6EKP-11	
90919-01195	BKR6EKP-11	
90919-01196	BKR5EKP-11	
90919-01197	BKR5EKP-11	
90919-01198	BKR6EKB-11	
90919-01201	BKR5EKP-13	
90919-01202	BKR6EKB-11	
90919-01207	BKR6EIX-11P	
90919-01208	BKR6EPA-8	
90919-01209	BKR5EIX-11P	
90919-01210	IFR6T11	
90919-01211	IFR6T11	
90919-01213	BKR6EPA-8	
90919-01214	BKR5EIX-P	
90919-01218	IFR5T11	
90919-01219	BKR5EIX-11P	
90919-01220	BKR6EP-11	
90919-01221	HB6AIX-11P	
90919-01225	BKR6EIX-11P	
90919-01226	HB6BIX-11P	
90919-01230	HB6BIX-11P	
90919-01233	ILFR5T11	
90919-01234	ILFR5T11	
90919-01235	LFR6C-11	
90919-01236	LFR6C-11	
90919-01237	IFR6T11	
90919-01238	IFR6T11	
90919-01242	BKR5EYA-11	39
90919-01244	BKR5EYA	
90919-01245	BKR5EYA	
90919-01247	DILFR6D11	
90919-01249	DFH6B-11A	
90919-01253	ILKAR7B11	
90919-YZZAA	BCP5E	16
90919-YZZAB	BCP6E	17
90919-YZZAC	BKR6E-11	14
90919-YZZAD	BKR5EYA	
90919-YZZAE	BKR5EYA-11	39
90919-YZZAF	BKR6EYA	
90919-YZZAG	BKR6EYA-11	
90999-09006	BP5EY	

TOYOTA	→ NGK	V-Line
90999-09007	BP6EY	
99098-22695	BP7ES	
UNIPART, SUREFIRE	→ NGK	V-Line
GSP 30	B6S	
GSP 96 SZ	PFR6N-11	
GSP 130	B5ES	
GSP 131	BP5ES	8
GSP 141	BP5ES	8
GSP 151	BP6ES	4
GSP 160	B6ES	
GSP 163	BP6ES	4
GSP 171	BP6ES	4
GSP 181	BP7ES	
GSP 191	BP8ES	
GSP 244	BPR5ES	6
GSP 263	BPR6ES	2
GSP 264	BPR5ES	6
GSP 281	BPR7ES	19
GSP 331	BP5EFS	
GSP 351	BP5EFS	
GSP 361	BP6EFS	5
GSP 381	BP7EFS	
GSP 461	BPR6EFS	7
GSP 531	BP5HS	
GSP 540	B5HS	
GSP 541	BP6HS	18
GSP 550	B6HS	
GSP 560	B7HS	
GSP 571	BP7HS	
GSP 634	BKR5ES	35
GSP 664	BKR6ES	28
GSP 665	BCP6ES	17
GSP 684	BCPR7ES	
GSP 685	BCP7ES	
GSP 761	BP6FS	
GSP 881	BPR6FS	
GSP 981	AP6FS	
GSP 2004	ZFR6F-11	
GSP 2007	BKR6ES	28
GSP 4154	AP6FS	
GSP 4266	B5HS	
GSP 4352	BP6ES	4
GSP 4356	BP6HS	18
GSP 4362	BP6ES	4
GSP 4366	BP6HS	18
GSP 4372	BP5ES	8
GSP 4376	BP5HS	
GSP 4382	BP5ES	8
GSP 4452	BPR7ES	19
GSP 4462	BPR6ES	2
GSP 4472	BPR5ES	6



UNIPART, SUREFIRE	→ NGK	V-Line
GSP 4552	BCP7ES	
GSP 4562	BCP6ES	17
GSP 4563	BP6EFS	5
GSP 4573	BP5EFS	
GSP 4652	BCPR7ES	
GSP 4662	BKR6ES	28
GSP 4663	BPR6EFS	7
GSP 6356	BP6HS	18
GSP 6382	BP5ES	8
GSP 6452	BPR7ES	19
GSP 6462	BPR6ES	2
GSP 6468	BPR6ES-11	13
GSP 6472	BPR5ES	6
GSP 6651	PTR5A-13	25
GSP 6652	BKR6ES	28
GSP 6658	BCPR7ES-11	
GSP 6662	BKR6ES	28
GSP 6663	BPR6EFS	7
GSP 6668	BKR6ES-11	14
GSP 9652	PFR6J	
GSP 46515	PTR5A-13	25

VOLVO	→ NGK	V-Line
1150 278	IFR6B11	
1367 528	BPR6ES	2
1367 529	BPR6ES	2
22401 AA670	IFR6B11	
2707 46	BPR6ES	2
2712 39	IZFR6B	
2716 03	BKR6E	28
2717 27	BKR6E	28
3063 7308	PFR6B	
3063 7308 791	PFR6B	
3063 7308 887	PFR6B	
3063 7385	LFR6D	
3063 7385 496 A	LFR6D	
3065 0843	LFR6D	
3071 3859	LFR6D	
3073 1383	IFR6B11	
3073 1425	TR5B-13	
3073 1878	TR6AP-13	
3075 1468 889	ILFR6B	
3075 1469	LFR6D	
3075 1805	ILFR6B	
3075 1806	ILFR6B	
3075 8130	ILZTR6A8G	
3077 7349	TR6AP-13	
3121 6183	ILFR6B	
3121 6184	ILFR6B	
3121 6297	ITR6F13	
3121 6525	ITR6F13	

VOLVO	→ NGK	V-Line
3121 6674	ILFR6K8	
3127 2399	ILFR6K8	
3133 0450	ILZTR6A8G	
3517 980	BKR6ES	28
3650 843	LFR6D	
8642 660	BKR6ETUC	
8642 661	BKR6EQUA	
8670 058	BKR6EIX	
8687 990 H 939	IFR6B11	
8692 070	PFR6B	
8692 071	PFR6B	
8692 072	PFR6B	
8694 749	ITR6F13	
9146 775	BKR6ETUC	
9146 7759 01	BKR6EQUA	
9146 7759 07	BKR6EQUA	

VW Group	→ NGK	V-Line
03C 905 601 A	PZFR6R8EG	
03F 905 600 A	IZFR6P7	
06H 905 601 A	PFR7S8EG	
101 000 000 AB	BP6ESZ	
101 000 001 AB	BUR6ET	1
101 000 001 AC	BUR6ET	1
101 000 001 AD	BP5ET-10	
101 000 001 AE	BP5ET	
101 000 002 AB	BP6ESZ	
101 000 003 AA	BCP7ET	
101 000 004 AA	BCP7ET	
101 000 005 AA	BUR6ET	1
101 000 005 AB	BUR6ET	1
101 000 005 AC	BP7ET	
101 000 005 AD	BP5ET-10	
101 000 005 AE	BP5ET	
101 000 005 AF	BP5ET	
101 000 006 AB	BP6ESZ	
101 000 006 AC	BP6ESZ	
101 000 007 AA	BUR6ET	1
101 000 007 AB	BUR6ET	1
101 000 007 AC	BP5ET-10	
101 000 007 AD	BUR6ET	1
101 000 016 AA	PFR7B	
101 000 016 AB	PFR6Q	37
101 000 017 AA	BCP7ET	
101 000 026 AA	BUR5ET	22
101 000 026 AB	BUR6ET	1
101 000 027 AA	BUR6ET	1
101 000 027 AB	BP5ET	
101 000 027 AC	BP5ET-10	
101 000 028 AA	BCP7ET	
101 000 029 AA	BU6EFSZ	
101 000 029 AB	BUR6EFSZ	





ALFA ROMEO => FIAT Group		
AMG => MERCEDES		
AUDI => VW Group		
BENTLEY => VW Group		
BERU	→ NGK	D-Power
105 MJ	Y-403-1	
105 MN	Y-208T	
106 MJ	Y-403-1	
107 MJ	Y-810	
108 MJ	Y-810	
112 M	Y-302	
137 MJ	Y-403T	
141 MJ	Y-207T	
151 MJ	Y-208T	
155 MJ	Y-404	
161 MJ	Y-208T	
162 MJ	Y-207T	
170 MJ	Y-811	
171 MJ	Y-810	
601 MJ	Y-918J	2
602 MJ	Y-208T	
603 MJ	Y-924J	1
609 MJ	Y-924J	1
613 MJ	Y-924J	1
624 MJ	Y-924J	1
631 MJ	Y-907R	
633 MJ	Y-924J	1
636 MJ	Y-924J	1
642 MJ	Y-924J	1
657 MJ	Y-909R	
661 MJ	Y-910J	3
663 MJ	Y-924J	1
666 MJ	Y-910J	3
673 MJ	Y-115T1	
678 MJ	Y-128T	
685 MJ	Y-117RS	
688 MJ	Y-118T1	
689 MJ	Y-204TS1	
705 MJ	Y-107R	
719 MJ	Y-924J	1
730 MJ	Y-739R	
749 MJ	Y-306R	
783 MJ	Y-729U	34
844 MJ	Y-933J	25
852 MJ	Y-913J	15
853 MJ	Y-712RS	
854 MJ	Y-712RS	
855 MJ	Y-732J	4
857 MJ	Y-918J	2

BERU	→ NGK	D-Power
858 MJ	Y-916J	6
860 MJ	Y-930U	30
880 MJ	Y-157R	
886 MJ	Y-146R	
887 MJ	Y-181T	
888 MJ	Y-204RS	
889 MJ	Y-112M1	
890 MJ	Y-162R1	
892 MJ	Y-112R1	
894 MJ	Y-118R	
895 MJ	Y-197R	
896 MJ	Y-168R	
897 MJ	Y-147T	
898 MJ	Y-115R1	
905 MJ	Y-730U	17
908 MJ	Y-924J	1
909 MJ	Y-924J	1
912 MJ	Y-503J	10
917 MJ	Y-924J	1
920 MJ	Y-705RS	
921 MJ	Y-707RS	
922 MJ	Y-757RS	
925 MJ	Y-926U	
927 MJ	Y-910J	3
944 MJ	Y-604J	
945 MJ	Y-307R	
946 MJ	Y-710J	
947 MJ	Y-711J	28
948 MJ	Y-925J	16
950 MJ	Y-732J	4
954 MJ	Y-924J	1
959 MJ	Y-933J	25
961 MJ	Y-929U	41
963 MJ	Y-506J	7
964 MJ	Y-738U	
968 MJ	Y-715R	
969 MJ	Y-197T	
970 MJ	Y-928U	29
991 MJ	Y-927J	19
999 MJ	Y-740U	22
GE 100	Y-607AS	50
GE 101	YE14	48
GE 102	Y-547AS	47
GE 105	Y8002AS	51
GE 108	Y-609AS	49
GE 110	Y1035AS	77
GE 111	Y1036AS	
GE 115	Y-609AS	49
GN 003	Y-745U	11
GN 005	Y-701J	39
GN 007	Y-741U	20
GN 008	Y-501U	31





BERU	→ NGK	D-Power
GN 010	Y-746J	38
GN 012	Y-502R	
GN 013	Y-924J	1
GN 015	Y-543J	46
GN 016	Y-503J	10
GN 017	Y-747U	26
GN 018	Y-732J	4
GN 019	Y-516J	12
GN 022	Y-937J	5
GN 024	Y-507J	32
GN 026	Y-517J	66
GN 027	Y-504J	24
GN 030	Y-939J	43
GN 033	Y-523J	37
GN 035	Y-749J	
GN 037	Y8005J	64
GN 039	Y-530J	
GN 041	Y-534J	36
GN 042	Y-542J	45
GN 043	Y-532J	
GN 044	Y-755RS	
GN 045	YE12	
GN 046	Y-741U	20
GN 047	YE04	40
GN 053	Y8003J	62
GN 054	Y1005J	56
GN 056	YE05	73
GN 057	Y-508J	
GN 058	YE13	
GN 059	YE07	
GN 062	Y-527J	67
GN 065	Y-531J	44
GN 103	Y-603J	60
GN 104	Y-541J	42
GN 108	Y1012J	65
GN 109	Y-519J	61
GN 110	Y1013J	63
GN 853	Y-712RS	
GN 854	Y-712RS	
GN 855	Y-732J	4
GN 857	Y-918J	2
GN 858	Y-916J	6
GN 860	Y-930U	30
GN 905	Y-730U	17
GN 908	Y-924J	1
GN 909	Y-924J	1
GN 912	Y-503J	10
GN 917	Y-924J	1
GN 925	Y-926U	
GN 927	Y-910J	3
GN 939	Y-548J	75
GN 944	Y-604J	

BERU	→ NGK	D-Power
GN 948	Y-925J	16
GN 954	Y-924J	1
GN 959	Y-933J	25
GN 961	Y-929U	41
GN 963	Y-506J	7
GN 964	Y-738U	
GN 970	Y-928U	29
GN 985	Y-605J	
GN 991	Y-927J	19
GN 992	Y-748U	14
GN 993	Y-524J	27
GN 999	Y-740U	22
GV 105	Y-208T	
GV 106	Y-403-1	
GV 107	Y-810	
GV 108	Y-810	
GV 112	Y-302	
GV 137	Y-403T	
GV 155	Y-404	
GV 170	Y-811	
GV 602	Y-208T	
GV 603	Y-924J	1
GV 631	Y-907R	
GV 636	Y-924J	1
GV 642	Y-924J	1
GV 657	Y-909R	
GV 661	Y-910J	3
GV 663	Y-924J	1
GV 666	Y-910J	3
GV 673	Y-115T1	
GV 678	Y-128T	
GV 685	Y-117RS	
GV 688	Y-118T1	
GV 689	Y-204TS1	
GV 705	Y-107R	
GV 719	Y-924J	1
GV 730	Y-739R	
GV 749	Y-306R	
GV 783	Y-729U	34
GV 844	Y-933J	25
GV 852	Y-913J	15
GV 880	Y-157R	
GV 886	Y-146R	
GV 887	Y-181T	
GV 888	Y-204RS	
GV 889	Y-112M1	
GV 890	Y-162R1	
GV 892	Y-112R1	
GV 894	Y-118R	
GV 895	Y-197R	
GV 896	Y-168R	
GV 897	Y-147T	



BERU	→ NGK	D-Power
GV 898	Y-115R1	
GV 920	Y-705RS	
GV 921	Y-707RS	
GV 922	Y-757RS	
GV 945	Y-307R	
GV 946	Y-710J	
GV 947	Y-711J	28
GV 968	Y-715R	
GV 969	Y-197T	
0 100 220 103	Y-207T	
0 100 220 113	Y-204RS	
0 100 220 114	Y-112M1	
0 100 220 115	Y-112R1	
0 100 220 118	Y-705RS	
0 100 220 206	Y-403T	
0 100 221 101	Y-302	
0 100 221 102	Y-208T	
0 100 221 103	Y-208T	
0 100 221 105	Y-918J	2
0 100 221 106	Y-208T	
0 100 221 107	Y-924J	1
0 100 221 132	Y-907R	
0 100 221 133	Y-924J	1
0 100 221 135	Y-924J	1
0 100 221 141	Y-909R	
0 100 221 144	Y-910J	3
0 100 221 145	Y-924J	1
0 100 221 146	Y-910J	3
0 100 221 147	Y-115T1	
0 100 221 148	Y-128T	
0 100 221 149	Y-117RS	
0 100 221 151	Y-118T1	
0 100 221 152	Y-204TS1	
0 100 221 154	Y-107R	
0 100 221 163	Y-924J	1
0 100 221 170	Y-739R	
0 100 221 186	Y-306R	
0 100 221 206	Y-404	
0 100 221 209	Y-403-1	
0 100 221 301	Y-811	
0 100 222 101	Y-118R	
0 100 222 102	Y-168R	
0 100 222 106	Y-508J	
0 100 222 301	Y-810	
0 100 222 302	Y-810	
0 100 226 129	Y-729U	34
0 100 226 163	Y-913J	15
0 100 226 164	Y-933J	25
0 100 226 170	Y-712RS	
0 100 226 171	Y-712RS	
0 100 226 173	Y-918J	2
0 100 226 180	Y-146R	

BERU	→ NGK	D-Power
0 100 226 182	Y-147T	
0 100 226 183	Y-115R1	
0 100 226 184	Y-730U	17
0 100 226 185	Y-924J	1
0 100 226 186	Y-924J	1
0 100 226 188	Y-503J	10
0 100 226 189	Y-924J	1
0 100 226 194	Y-707RS	
0 100 226 198	Y-910J	3
0 100 226 206	Y-604J	
0 100 226 207	Y-710J	
0 100 226 208	Y-711J	28
0 100 226 209	Y-307R	
0 100 226 227	Y-732J	4
0 100 226 229	Y-924J	1
0 100 226 234	Y-916J	6
0 100 226 235	Y-925J	16
0 100 226 237	Y-933J	25
0 100 226 238	Y-740U	22
0 100 226 243	Y-715R	
0 100 226 245	Y-506J	7
0 100 226 246	Y-738U	
0 100 226 249	Y-928U	29
0 100 226 250	Y-929U	41
0 100 226 255	Y-605J	
0 100 226 258	Y-930U	30
0 100 226 299	Y-927J	19
0 100 226 300	Y-748U	14
0 100 226 336	Y-701J	39
0 100 226 338	Y-501U	31
0 100 226 343	Y-741U	20
0 100 226 344	Y-504J	24
0 100 226 351	Y-517J	66
0 100 226 352	Y-530J	
0 100 226 354	Y-502R	
0 100 226 362	Y-507J	32
0 100 226 365	Y-746J	38
0 100 226 366	Y-924J	1
0 100 226 371	Y-503J	10
0 100 226 372	Y-747U	26
0 100 226 373	Y-732J	4
0 100 226 375	Y-516J	12
0 100 226 379	Y-745U	11
0 100 226 381	Y-937J	5
0 100 226 384	Y-524J	27
0 100 226 385	Y-548J	75
0 100 226 391	Y-939J	43
0 100 226 392	Y-543J	46
0 100 226 417	Y-523J	37
0 100 226 422	Y-749J	
0 100 226 432	Y-926U	
0 100 226 436	Y-534J	36



<b>BERU</b>	<b>→ NGK</b>	<b>D-Power</b>
0 100 226 475	Y-532J	
0 100 226 480	Y-542J	45
0 100 226 482	Y-741U	20
0 100 226 492	Y1005J	56
0 100 226 495	Y-603J	60
0 100 226 497	Y-541J	42
0 100 226 504	Y-732J	4
0 100 226 522	Y-527J	67
0 100 226 527	Y-531J	44
0 100 226 538	Y1012J	65
0 100 226 568	Y1013J	63
0 100 230 101	Y-181T	
0 100 230 102	Y-162R1	
0 100 230 107	Y-755RS	
0 100 231 104	Y-157R	
0 100 231 107	Y-197R	
0 100 231 109	Y-757RS	
0 100 231 114	Y-197T	
0 100 266 002	Y-547AS	47
0 100 266 008	Y-607AS	50
0 100 266 009	YE14	48
0 100 266 011	Y8002AS	51
0 100 266 016	Y-609AS	49
0 100 266 032	Y1035AS	77
0 100 266 033	Y1036AS	
0 100 266 040	Y-609AS	49
0 100 276 003	Y8005J	64
0 100 276 004	YE04	40
0 100 276 005	YE12	
0 100 276 008	Y8003J	62
0 100 276 012	YE05	73
0 100 276 014	YE13	
0 100 276 015	YE07	
0 100 800 031	Y-519J	61
<b>BMW</b>	<b>→ NGK</b>	<b>D-Power</b>
12 23 1 288 245	Y-924J	1
12 23 2 241 389	Y-924J	1
12 23 2 248 059	Y-507J	32
12 23 7 786 869	Y-547AS	47
<b>BOSCH</b>	<b>→ NGK</b>	<b>D-Power</b>
GA 135	DG-237	
GA 1351	DG-237	
GLP 001	Y-924J	1
GLP 002	Y-918J	2
GLP 003	Y-732J	4
GLP 004	Y-503J	10
GLP 005	Y-924J	1
GLP 006	Y-916J	6
GLP 007	Y-534J	36
GLP 009	Y-506J	7

<b>BOSCH</b>	<b>→ NGK</b>	<b>D-Power</b>
GLP 010	Y-910J	3
GLP 011	Y-516J	12
GLP 012	Y-937J	5
GLP 013	Y-504J	24
GLP 014	Y-730U	17
GLP 015	Y-924J	1
GLP 016	Y8003J	62
GLP 017	Y-925J	16
GLP 019	Y-748U	14
GLP 020	Y-927J	19
GLP 021	Y-929U	41
GLP 022	Y-745U	11
GLP 023	Y-741U	20
GLP 024	Y-524J	27
GLP 025	Y-930U	30
GLP 026	Y-928U	29
GLP 030	Y-523J	37
GLP 031	Y-501U	31
GLP 032	Y-747U	26
GLP 034	Y-115T1	
GLP 035	Y-603J	60
GLP 036	Y-933J	25
GLP 037	Y-913J	15
GLP 038	Y-701J	39
GLP 039	CY57	21
GLP 040	Y-507J	32
GLP 041	Y-739R	
GLP 042	Y-118T1	
GLP 043	YE07	
GLP 045	Y-939J	43
GLP 046	Y-711J	28
GLP 047	Y-909R	
GLP 048	Y-729U	34
GLP 049	Y-712RS	
GLP 050	Y-607AS	50
GLP 051	Y-548J	75
GLP 054	Y-733J	13
GLP 057	Y-517J	66
GLP 059	YE04	40
GLP 063	Y-810	
GLP 066	Y1030J	70
GLP 070	Y-547AS	47
GLP 072	Y-710J	
GLP 074	Y-532J	
GLP 093	YE14	48
GLP 096	Y-306R	
GLP 098	Y-755RS	
GLP 101	Y-531J	44
GLP 102	Y-746J	38
GLP 103	Y-904M1	
GLP 105	CY52	
GLP 108	CY51	



BOSCH	→ NGK	D-Power
GLP 109	Y1031J	71
GLP 111	Y1005J	56
GLP 115	YE12	
GLP 116	Y-118R	
GLP 117	Y-107R	
GLP 120	Y-307R	
GLP 121	Y-910J	3
GLP 124	Y-146R	
GLP 125	Y-103	
GLP 127	Y-705RS	
GLP 128	Y-403T	
GLP 130	Y-302	
GLP 132	Y-197T	
GLP 133	Y-543J	46
GLP 136	Y-197R	
GLP 137	Y1007J	59
GLP 138	Y-162R1	
GLP 142	Y-147T	
GLP 144	Y8008AS	74
GLP 152	Y-178T	
GLP 155	Y-112T	
GLP 156	Y1006J	
GLP 159	Y-128T	
GLP 167	Y-117RS	
GLP 169	Y-157R	
GLP 171	Y-404	
GLP 172	Y-403-1	
GLP 185	Y-181T	
GLP 186	Y-907R	
GLP 196	Y9003AS	
GLP 202	Y8002AS	51
GSA 91	Y-810	
GSA 101	Y-810	
KEGA 121	DG-237	
KEGA 1211	DG-237	
KEGSA 1010	Y-811	
0 250 001 008	DG-237	
0 250 001 012	DG-237	
0 250 001 016	DG-237	
0 250 001 416	DG-237	
0 250 200 013	Y-811	
0 250 200 014	Y-810	
0 250 200 020	Y-810	
0 250 200 035	Y-302	
0 250 200 037	Y-404	
0 250 200 046	Y-403-1	
0 250 200 049	Y-207T	
0 250 200 051	Y-403T	
0 250 200 052	Y-207T	
0 250 200 053	Y-909R	
0 250 200 054	Y-208T	
0 250 200 055	Y-810	

BOSCH	→ NGK	D-Power
0 250 200 056	Y-208T	
0 250 200 058	Y-208T	
0 250 200 059	Y-208T	
0 250 200 060	Y-208T	
0 250 200 063	Y-207T	
0 250 200 065	Y-208T	
0 250 200 068	Y-208T	
0 250 200 069	Y-924J	1
0 250 200 420	Y-810	
0 250 200 451	Y-403T	
0 250 200 454	Y-208T	
0 250 200 456	Y-208T	
0 250 200 465	Y-208T	
0 250 200 468	Y-208T	
0 250 201 001	Y-924J	1
0 250 201 004	Y-918J	2
0 250 201 005	Y-924J	1
0 250 201 006	Y-924J	1
0 250 201 008	Y-924J	1
0 250 201 009	Y-924J	1
0 250 201 011	Y-918J	2
0 250 201 012	Y-909R	
0 250 201 013	Y-924J	1
0 250 201 015	Y-918J	2
0 250 201 017	Y-907R	
0 250 201 019	Y-924J	1
0 250 201 021	Y-918J	2
0 250 201 026	Y-916J	6
0 250 201 027	Y-924J	1
0 250 201 029	Y-913J	15
0 250 201 032	Y-918J	2
0 250 201 033	Y-924J	1
0 250 201 034	Y-909R	
0 250 201 035	Y-930U	30
0 250 201 038	Y-925J	16
0 250 201 039	Y-924J	1
0 250 201 041	Y-916J	6
0 250 201 042	Y-924J	1
0 250 201 043	Y-913J	15
0 250 201 049	Y-937J	5
0 250 201 050	Y-933J	25
0 250 201 053	Y-939J	43
0 250 201 405	Y-924J	1
0 250 201 415	Y-918J	2
0 250 202 001	Y-910J	3
0 250 202 002	Y-739R	
0 250 202 003	Y-115T1	
0 250 202 004	Y-128T	
0 250 202 005	Y-117RS	
0 250 202 006	Y-118T1	
0 250 202 007	Y-107R	
0 250 202 008	Y-306R	



<b>BOSCH</b>	<b>→ NGK</b>	<b>D-Power</b>
0 250 202 009	Y-732J	4
0 250 202 013	Y-204RS	
0 250 202 015	Y-103	
0 250 202 017	Y-112R1	
0 250 202 018	Y-910J	3
0 250 202 020	Y-503J	10
0 250 202 022	Y-732J	4
0 250 202 023	Y-741U	20
0 250 202 024	Y-927J	19
0 250 202 025	Y-730U	17
0 250 202 026	Y-929U	41
0 250 202 028	Y-747U	26
0 250 202 029	Y-745U	11
0 250 202 030	Y-543J	46
0 250 202 032	Y-504J	24
0 250 202 033	Y-910J	3
0 250 202 034	Y-928U	29
0 250 202 035	Y-506J	7
0 250 202 036	Y-534J	36
0 250 202 038	Y1031J	71
0 250 202 040	Y-729U	34
0 250 202 041	Y-746J	38
0 250 202 042	Y-748U	14
0 250 202 043	Y-523J	37
0 250 202 051	Y-146R	
0 250 202 054	Y-118R	
0 250 202 058	Y-147T	
0 250 202 064	Y-755RS	
0 250 202 065	Y-904M1	
0 250 202 069	Y-162R1	
0 250 202 071	Y-181T	
0 250 202 076	Y-197R	
0 250 202 077	Y-705RS	
0 250 202 085	Y-710J	
0 250 202 086	Y-307R	
0 250 202 087	Y-711J	28
0 250 202 089	Y-701J	39
0 250 202 090	Y1006J	
0 250 202 092	Y-733J	13
0 250 202 093	Y-712RS	
0 250 202 094	Y-115T1	
0 250 202 095	Y-532J	
0 250 202 096	Y-118T1	
0 250 202 097	Y-197T	
0 250 202 102	Y-501U	31
0 250 202 103	Y-507J	32
0 250 202 107	Y-157R	
0 250 202 110	Y-112T	
0 250 202 119	Y-178T	
0 250 202 124	Y1007J	59
0 250 202 125	Y-531J	44
0 250 202 128	Y-517J	66

<b>BOSCH</b>	<b>→ NGK</b>	<b>D-Power</b>
0 250 202 129	Y-516J	12
0 250 202 130	Y-548J	75
0 250 202 131	Y-524J	27
0 250 202 132	Y1030J	70
0 250 202 135	Y1005J	56
0 250 203 001	YE07	
0 250 203 002	Y8003J	62
0 250 203 004	YE12	
0 250 204 001	YE04	40
0 250 312 001	CY51	
0 250 312 002	CY52	
0 250 312 003	Y-603J	60
0 250 312 007	CY57	21
0 250 402 002	Y-547AS	47
0 250 402 005	Y-607AS	50
0 250 403 001	Y8008AS	74
0 250 403 002	YE14	48
0 250 403 008	Y8002AS	51
0 250 403 011	Y9003AS	

<b>BRISK</b>	<b>→ NGK</b>	<b>D-Power</b>
21 N 21	Y-208T	
21 N 22	Y-208T	
21 N 51	Y-909R	
21 R 01	Y-918J	2
21 R 02	Y-907R	
21 R 06	Y-918J	2
21 R 21	Y-924J	1
21 R 22	Y-924J	1
21 R 23	Y-924J	1
21 R 26	Y-913J	15
21 R 51	Y-909R	
21 R 71	Y-910J	3
41 N 71	Y-403T	

**BUICK => GM**

**CADILLAC => GM**

<b>CHAMPION</b>	<b>→ NGK</b>	<b>D-Power</b>
AG 32	Y-302	
AG 44	Y-811	
CH 32	Y-302	
CH 44	Y-811	
CH 60	Y-207T	
CH 61	DG-237	
CH 63	Y-208T	
CH 64	Y-404	
CH 65	Y-810	
CH 66	Y-403T	





CHAMPION	→ NGK	D-Power
CH 68	Y-523J	37
CH 69	Y-918J	2
CH 70	Y-909R	
CH 78	Y-208T	
CH 79	Y-907R	
CH 88	Y-924J	1
CH 90	Y-739R	
CH 94	Y-115T1	
CH 95	Y-146R	
CH 96	Y-204RS	
CH 97	Y-107R	
CH 98	Y-117RS	
CH 99	Y-117SS	
CH 101	Y-115R1	
CH 102	Y-112M1	
CH 103	Y-118T1	
CH 104	Y-197R	
CH 105	Y-204SS	
CH 121	Y-118T1	
CH 137	Y-924J	1
CH 147	Y-910J	3
CH 154	Y-715R	
CH 158	Y-711J	28
CH 159	Y-924J	1
CH 160	Y-918J	2
CH 161	Y-755RS	
CH 162	Y-707RS	
CH 163	Y-924J	1
CH 166	Y-747U	26
CH 167	Y-928U	29
CH 169	Y-730U	17
CH 170	Y-504J	24
CH 171	Y-732J	4
CH 172	Y-740U	22
CH 173	Y-913J	15
CH 174	Y-924J	1
CH 175	Y-930U	30
CH 176	Y-916J	6
CH 177	Y-925J	16
CH 178	Y-729U	34
CH 179	Y-933J	25
CH 181	Y-741U	20
CH 184	Y-732J	4
CH 185	Y-503J	10
CH 189	Y-924J	1
CH 196	Y-524J	27
CH 203	Y-507J	32
CH 204	Y-929U	41
CH 205	Y-937J	5
CH 206	Y-927J	19
CH 207	Y-748U	14
CH 208	Y-738U	

CHAMPION	→ NGK	D-Power
CH 215	Y-501U	31
CH 216	Y-502R	
CH 217	Y-506J	7
CH 218	Y-745U	11
CH 219	Y-746J	38
CH 221	Y-115T1	
CH 223	Y8003J	62
CH 224	YE07	
CH 263	Y1007J	59
CH 268	Y1005J	56
CH 600	CY52	
CH 601	Y-603J	60
CH 602	CY57	21
<b>CHEVROLET =&gt; GM</b>		
<b>CHRYSLER</b>		
→ NGK	D-Power	
05066 840 AA	Y1031J	71
5175 756 AA	Y8002AS	51
<b>CITROËN =&gt; PSA</b>		
<b>DACIA =&gt; RENAULT</b>		
<b>DAEWOO =&gt; GM</b>		
<b>DAIHATSU</b>		
→ NGK	D-Power	
19850-54050-000	Y-118R	
19850-54071-000	Y-146R	
19850-54090-000	Y-715R	
19850-56010-000	Y-178	
19850-56012-000	Y-178T	
19850-58030-000	Y-128T	
19850-58040-000	Y-178T	
19850-64010-000	Y-146R	
19850-64020-000	Y-703R	
19850-68010-000	Y-147T	
19850-68040-000	Y-178T	
19850-68060-000	Y-197R	
19850-87303-000	Y-108	
19850-87309-000	Y-128T	
19850-87701-000	Y-146R	
19850-87702-000	Y-703R	
19850-87801	Y-706R	
<b>DENSO</b>		
→ NGK	D-Power	
DG 001	Y-924J	1
DG 002	Y-204TS1	
DG 003	Y-503J	10
DG 004	Y-910J	3
DG 005	Y-732J	4



DENSO	→ NGK	D-Power
DG 006	Y-913J	15
DG 007	Y-937J	5
DG 008	Y-506J	7
DG 009	Y-927J	19
DG 010	Y-916J	6
DG 101	Y-740U	22
DG 102	Y-928U	29
DG 103	Y-933J	25
DG 105	Y-115T1	
DG 106	Y-925J	16
DG 110	Y-929U	41
DG 111	Y-502R	
DG 113	YE04	40
DG 115	Y-729U	34
DG 116	Y-504J	24
DG 117	Y-925J	16
DG 118	Y-748U	14
DG 119	Y-930U	30
DG 120	Y-707RS	
DG 123	Y-907R	
DG 124	Y-710J	
DG 126	Y-517J	66
DG 127	Y-747U	26
DG 137	Y-712RS	
DG 144	Y-732J	4
DG 145	Y-507J	32
DG 146	Y-701J	39
DG 155	Y-746J	38
DG 159	Y-307R	
DG 161	Y-924J	1
DG 170	YE07	
DG 171	Y8003J	62
DG 202	Y-909R	
DG 211	Y-715R	
DG 214	Y-532J	
DG 215	Y-118R	
DG 216	Y-703R	
DG 221	Y-118T1	
DG 222	Y-197R	
DG 223	Y-146R	
DG 232	Y-147T	
DG 233	Y-197T	
DG 234	Y-128T	
DG 235	Y-178T	
DG 239	Y-168R	
DG 240	Y-542J	45
DG 245	Y-531J	44
DG 300	Y-603J	60
DG 301	CY57	21
DG 304	CY52	
671 000 160	DG-211	
671 001 042	Y-402-2	

DENSO	→ NGK	D-Power
671 001 043	Y-452-1	
671 001 070	Y-176	
671 001 071	Y-176	
671 001 090	Y-108	
671 001 120	Y-178	
671 001 130	Y-128	
671 001 161	Y-178T	
671 001 170	Y-128T	
671 001 171	Y-128T	
671 001 270	Y-118T1	
671 001 330	Y-147T	
671 001 340	Y-197T	
671 001 350	Y-128T	
671 001 360	Y-178T	
671 001 370	Y-118R	
671 001 380	Y-168R	
671 001 430	Y-146R	
671 001 460	Y-197R	
671 001 530	Y-146R	
671 001 630	Y-118T1	

#### DODGE => CHRYSLER

EIKO	→ NGK	D-Power
GD 901	Y-108	
GF 101	Y-175-2	
GF 102	Y-201	
GF 103	Y-274	
GF 104	Y-172	
GF 105	Y-172	
GF 106	Y-102	
GF 110	Y-180	
GF 112	Y-115T1	
GH 402	Y-176	
GI 001	Y-874-1	
GI 003	Y-104	
GI 008	Y-271-2	
GM 501	Y-107T	
GM 502	Y-107R	
GM 503	Y-157R	
GM 504	Y-172	
GN 302	Y-103	
GN 303	Y-103-2	
GN 304	Y-202	
GN 305	Y-252	
GN 306	Y-112T	
GN 308	Y-181T	
GN 309	Y-204TS1	
GN 310	Y-103-1	
GN 311	Y-272R1	
GT 201	Y-402-2	
GT 202	Y-452-1	



EIKO	→ NGK	D-Power
GT 203	Y-128	
GT 204	Y-178	
GT 207	Y-178T	
GT 208	Y-128T	
GT 211	DG-211	
GT 212	Y-146R	
EUROCARB	→ NGK	D-Power
111	Y-918J	2
FIAT Group	→ NGK	D-Power
46 44 76 10	Y-928U	29
46 45 19 51	Y-747U	26
46 75 17 64	Y-939J	43
46 75 41 54	Y-534J	36
46 79 23 55	YE07	
46 79 23 59	YE07	
46 79 60 50	Y8003J	62
50 03 16 493	Y-502R	
50 03 51 992	Y8005J	64
55 18 78 63	YE07	
55 20 07 55	Y9003AS	
55 20 08 17	Y1030J	70
55 21 00 51	Y9001AS	72
60 50 71 23	Y-909R	
60 81 22 92	Y-924J	1
60 81 46 13	Y-747U	26
71 71 90 15	Y-924J	1
76 32 58 7	Y-739R	
77 35 92 0	Y-924J	1
96 33 21 43 80	Y-924J	1
96 38 98 59 80	Y-504J	24
96 51 02 97 80	Y-504J	24
96 51 58 36	Y1005J	56
96 52 54 82 80	YE08	
96 59 27 92 80	Y-548J	75
98 46 24 92	Y-926U	
FORD	→ NGK	D-Power
11 48 105	YE04	40
13 13 809	Y1005J	56
14 27 905	YE08	
14 47 128	YE05	73
14 59 460	Y-548J	75
14 73 356	Y1005J	56
15 42 845	Y8003J	62
16 82 276	Y8001AS	58
40 25 139	Y-701J	39
2S6Q-6M090-AA	YE04	40
2S6Q-6M090-BA	YE05	73
2S6Q-6M090-BB	YE05	73

FORD	→ NGK	D-Power
3M5Q-6M090-AB	Y1005J	56
3M5Q-6M090-AC	Y1005J	56
6G9Q-6M090-AA	YE08	
7C16-6M090-AA	Y-548J	75
9S51-6M090-AA	Y8003J	62
AV6Q-6M090-BA	Y8001AS	58
BS51-6M090-AA	Y9001AS	72
XM341-2A342-BA	Y-701J	39
GM	→ NGK	D-Power
93 178 411	YE07	
94 133 759	Y-904M1	
94 439 218	Y-306R	
HONDA	→ NGK	D-Power
31800-706-000	YS-101	
HYUNDAI / KIA	→ NGK	D-Power
OK04S-18140-A	Y-721J	
OK054-18140	Y-701J	39
36710-27000	Y-749J	
36710-27010	Y-749J	
36710-2A100	Y-527J	67
36710-2A700	CZ203	68
36710-2F000	CZ105	
36710-2F100	Y1003AS	
36710-42000	Y-722JS	
36710-42020	Y-722JS	
36710-42500	CY57	21
36710-42510	CY57	21
36710-4A000	Y-508J	
36710-4A100	Y-508J	
36710-4X900	Y-535J	
ISUZU	→ NGK	D-Power
94175-158	Y-904M1	
5-86101-642-0	CY58	
5-86101-643-0	Y-712RS	
5-86101-644-0	Y-707RS	
5-86115-977-0	Y-757RS	
8-84402-303-1	Y-711J	28
8-94135-377-3	Y-954M1	
8-94175-158-0	Y-904M1	
8-94175-158-1	Y-904M1	
8-94175-158-2	Y-904M1	
8-94221-719-3	Y-954M1	
8-94319-700-1	Y-710J	
8-94319-700-2	Y-710J	
8-94319-700-4	Y-710J	



<b>ISUZU</b>	<b>→ NGK</b>	<b>D-Power</b>
8-97033-761-0	Y-954M1	
8-97033-761-1	Y-954M1	
8-97033-761-2	Y-954M1	
8-97080-554-0	Y-603J	60
8-97080-554-1	Y-603J	60
8-97106-549-1	Y-720U1	
8-97106-549-4	Y-720U1	
9-82511-945-0	Y-874-1	
9-82511-978-0	Y-104	
9-82511-978-1	Y-104	
9-82511-994-0	Y-874-1	
9-82513-928-2	Y-271-2	
<b>KIA =&gt; HYUNDAI/KIA</b>		
<b>KOMATSU → NGK D-Power</b>		
600-815-2760	Y-703R	
600-815-2761	Y-703M1	
<b>KUBOTA → NGK D-Power</b>		
8412	Y-103K	
15204-65511	Y-110	
15221-65513	Y-106-1	
15231-65512	Y-107-1	
15261-65512	Y-103K	
15261-65514	Y-103K	
15451-65511	Y-203	
15521-65510	Y-106V	
15521-65512	Y-106V	
15571-65511	Y-203V	
15571-65512	Y-203V	
15694-65512	Y-702R	
15694-65513	Y-702R	
15806-65512	Y-706R	
15806-65513	Y-706R	
15951-65511	Y-103V	
15951-65512	Y-103V	
15951-65513	Y-103V	
16241-65511	Y-709R	
16241-65512	Y-709R	
16415-65511	Y-713R	
16415-65512	Y-713R	
16665-65512	Y-766MS	
16851-65510	YA01	
16851-65512	YE01	
16881-65513	YE52	
17331-65511	Y-119V	
17529-65511	YA01	
19077-65511	Y-716RS	
19077-65512	Y-716RS	
19077-65513	Y-716RS	
19215-65511	Y-149	

<b>KUBOTA</b>	<b>→ NGK</b>	<b>D-Power</b>
19215-65512	Y-149	
19215-65513	Y-149	
<b>LANCIA =&gt; FIAT Group</b>		
<b>LAND ROVER → NGK D-Power</b>		
ERR 6066	Y-605J	
LR 001 302	YE08	
<b>LEXUS =&gt; TOYOTA</b>		
<b>MARELLI → NGK D-Power</b>		
061 830 024 304	Y-918J	2
061 830 025 304	Y-924J	1
061 830 078 304	Y-924J	1
TIX 1 A	Y-207T	
TIX 2 A	Y-208T	
TIX 4 A	Y-208T	
TIX 6 A	Y-208T	
UX 1 A	Y-918J	2
UX 2 A	Y-924J	1
UX 4 A	Y-924J	1
<b>MAZDA → NGK D-Power</b>		
1304-18-140	Y-172	
1353-18-140	Y-107T	
1353-18-140A	Y-107T	
1N01-18-601A	CY51	
1N02-18-601	CY52	
4869-18-140	Y-122	
4869-18-140A	Y-122	
R2L2-18-601	Y-721RS	
RF2A-18-601	Y-529J	
RFG1-18-601	Y-701J	39
RFJ5-18-601	Y-701J	39
RFS5-18-601	Y1006J	
RFS5-18-601A	Y1006J	
S201-18-140	Y-107R	
S210-18-140	Y-701J	39
S501-18-140A	Y-107R	
SE01-18-140A	Y-157R	
SEM1-18-601	Y-771R	
VS01-18-601	Y-721RS	
WE01-18-601	Y-526J1	69
WL03-18-601	Y-701J	39
WL81-18-601	Y-701J	39
Y701-18-601	Y-603J	60
<b>MERCEDES → NGK D-Power</b>		
A 000 159 61 01	DG-237	
A 000 159 81 01	Y-924J	1



<b>MERCEDES</b>	<b>→ NGK</b>	<b>D-Power</b>
A 001 159 15 01	Y-930U	30
A 001 159 20 01	Y-925J	16
A 001 159 21 01	Y-925J	16
A 001 159 26 01	Y-929U	41
A 001 159 27 01	Y-746J	38
A 001 159 28 01	Y-745U	11
A 001 159 35 01	Y-924J	1
A 001 159 36 01	Y-916J	6
A 001 159 37 01	Y-745U	11
A 001 159 38 01	Y-745U	11
A 001 159 42 01	Y-745U	11
A 001 159 46 10	YE13	
A 001 159 48 01	Y-745U	11
A 001 159 49 01	Y-745U	11
A 001 159 50 01	Y8002AS	51
A 001 159 56 01	CZ106	53
A 001 159 57 01	CZ303	54
A 001 159 58 01	CZ303	54
A 001 159 66 01	CZ303	54
A 001 159 68 01	CZ106	53
A 667 159 00 01	Y-537AS	
Q0 004 562 V003 00 0000	Y-543J	46

**MINI => BMW**

<b>MITSUBISHI</b>	<b>→ NGK</b>	<b>D-Power</b>
1820 A 009	CZ251	76
30666-57301	Y-114T	
30666-57302	Y-114T	
30666-57303	Y-114T	
30L66-00300	Y-723R	
30L66-00301	Y-723R	
30L66-00302	Y-723R	
30L66-00400	Y-723U	
30L66-00400 9V	Y-723U	
30L66-00401	Y-723U	
30L66-00402	Y-723U	
31366-14300	Y-201	
31366-14301	Y-201	
31366-14302	Y-201	
31A66-03100	Y-701U	
31A66-03101	Y-701U	
31A66-03102	Y-701U	
32A66-07010	Y-904M1	
32A66-07020	Y-954M1	
32A66-07021	Y-954M1	
32A66-07100	Y-904M1	
32A66-07200	Y-954M1	
32C98-55808	Y-722JS	
34466-21300	Y-182T	
34466-21301	Y-182T	
34466-31301	Y-182T1	

<b>MITSUBISHI</b>	<b>→ NGK</b>	<b>D-Power</b>
36710-42500	CY57	21
91304-04300	Y-701J	39
EE 960 02	Y-104	
K9 670 240	Y-201	
M 816 732	Y-933J	25
MD 014 997	Y-115R1	
MD 050 212	Y-115T1	
MD 077 167	Y-707RS	
MD 197 511	CY57	21
MD 301 950	Y-733J	13
MD 344 469	Y-733J	13
ME 017 009	Y-274R	
ME 017 010	Y-274	
ME 017 013	Y-274	
ME 017 057	Y-971M	
ME 200 970	CZ256	
ME 201 638	CZ256	
ME 203 539	Y1007J	59
ME 203 754	CZ256	
MM 401 621	Y-110	
MM 401 621 01	Y-110	
MM 401 621 02	Y-110	
MM 431 439 01	Y-142T	
MM 432 148	Y-145T	
MN 960 270	YE13	
MN 960 296	YE13	
MN 980 234	YE14	48
MN 980 406	CZ304	55
MR 577 131	Y-733J	13

<b>MOTORCRAFT</b>	<b>→ NGK</b>	<b>D-Power</b>
10 56 857	Y-937J	5
10 79 401	Y-524J	27
10 96 527	Y-548J	75
16 90 048	Y-741U	20
32 52 725	Y-107R	
50 23 372	Y-208T	
50 31 006	Y-924J	1
61 32 246	Y-907R	
61 54 593	Y-924J	1
70 88 988	Y-910J	3
84BB6-M090-AA	Y-924J	1
84FF6-M090-B2A	Y-907R	
93FF6-M090-AA	Y-910J	3
96FF6-M090-CA	Y-937J	5
EZD 1	Y-810	
EZD 5	Y-924J	1
EZD 10	Y-918J	2
EZD 18	Y-115T1	
EZD 19	Y-128T	
EZD 20	Y-117RS	





<b>MOTORCRAFT</b>	<b>→ NGK</b>	<b>D-Power</b>
EZD 21	Y-118T1	
EZD 22	Y-107T	
EZD 30	Y-924J	1
EZD 40	YE04	40
EZD 41	Y-504J	24
V94DX-6M090-AA	Y-924J	1
V95DD-6M090-AA	Y-741U	20
XS4U-6M090-AB	Y-524J	27
XS7U-6M090-BA	Y-548J	75

<b>NISSAN</b>	<b>→ NGK</b>	<b>D-Power</b>
11065-00Q0A	Y-517J	66
11065-02T00	Y-955RS	
11065-0W801	CY58	
11065-10G00	Y-705RS	
11065-10T01	Y-757RS	
11065-16A00	Y-117SS	
11065-16A05	Y-117RS	
11065-16A06	Y-144RS	
11065-16A10	Y-117SS	
11065-16A15	Y-117RS	
11065-16A16	Y-144RS	
11065-2TB0A	Y-519J	61
11065-2W202	CZ258	
11065-31N00	Y-712RS	
11065-31W00	Y-112T	
11065-31W01	Y-112T	
11065-31W02	Y-112TS	
11065-34W00	Y-112M1	
11065-37506	Y-103	
11065-37507	Y-103	
11065-43G01	Y-707RS	
11065-57J00	CY52	
11065-5C900	CY52	
11065-63G00	Y-707RS	
11065-63G00-GW	Y-707RS	
11065-65N01	CY58	
11065-7C000	Y-530J	
11065-89TA1	Y-954M1	
11065-9C600	Y-712RS	
11065-AD200	Y-519J	61
11065-AD201	Y-519J	61
11065-AD220	Y-519J	61
11065-C8600	Y-755RS	
11065-D2800	Y-120RS	
11065-DB000	Y-522J	
11065-G2400	Y-712RS	
11065-G2460	Y-712RS	
11065-G5501	CY51	
11065-HC200	Y-701J	39
11065-HC251	Y-721RS	

<b>NISSAN</b>	<b>→ NGK</b>	<b>D-Power</b>
11065-J2000	Y-202	
11065-J5501	Y-202-2	
11065-J5502	Y-202-2	
11065-J5570	Y-222T	
11065-0W801	CY58	
11065-Q4000	Y-103-2A	
11065-Q4001	Y-112T1	
11065-T3400	Y-177-1	
11065-T3401	Y-177-1	
11065-T3470	Y-181T	
11065-T8200	Y-112R1	
11065-T8201	Y-162R1	
11065-T8202	Y-112R1	
11065-T8203	Y-162R1	
11065-T9000	Y-272R1	
11065-T9001	Y-272R1	
11065-V0700	Y-204TS1	
11065-V0710	Y-204TS1	
11065-V7202	CX51	
11065-V7203	CZ51	
11065-W2500	Y-204RS	
11065-W2510	Y-204RS	
11065-W3400	Y-204SS	
11065-W3410	Y-204SS	
11065-Y1400	Y-103-1	
11065-Y1401	Y-103-1	
11065-Y1402	Y-103-2	
11065-Y1403	Y-103-2	
11065-Y1404	Y-103-2	
11065-Z5000	Y-252	
RFJ5-18601	Y-701J	39

<b>OPEL</b>	<b>→ NGK</b>	<b>D-Power</b>
12 14 032	Y8003J	62
12 14 034	YE07	
12 14 040	Y-534J	36
12 14 063	Y-541J	42
12 14 300	Y-810	
12 14 301	Y-541J	42
12 14 302	Y-403-1	
12 14 303	Y-403T	
12 14 304	Y-208T	
12 14 305	Y-523J	37
12 14 308	Y-306R	
12 14 309	Y-307R	
12 14 310	Y-719RS1	
12 14 311	Y-710J	
12 14 315	Y-719RS1	
12 14 316	Y-603J	60
12 14 319	Y-924J	1
12 14 321	Y-904M1	



OPEL	→ NGK	D-Power
12 14 323	Y-904M1	
12 14 324	Y-924J	1
12 14 427	Y-741U	20
12 14 457	Y-748U	14
44 03 145	Y-910J	3
09 111 145	Y-910J	3
09 118 201	Y-748U	14
09 196 669	Y-523J	37
90 093 867	Y-208T	
90 093 897	Y-208T	
90 510 924	Y-924J	1
90 540 864	Y-924J	1
91 153 919	Y-741U	20
93 178 047	Y8003J	62
93 178 411	YE07	
93 190 433	Y1030J	70
94 133 759	Y-904M1	
94 175 158	Y-904M1	
94 319 700	Y-710J	
94 402 303	Y-307R	
94 439 218	Y-306R	
94 481 972	Y-719RS1	
97 044 037	Y-719RS1	
97 080 554	Y-603J	60
97 210 818	Y-541J	42
97 725 357	Y-810	

**PEUGEOT => PSA**

PSA	→ NGK	D-Power
5960.12	YE04	40
5960.19	YE04	40
5960.64	Y1005J	56
5960.65	Y1005J	56
5960.66	Y-504J	24
5960.67	Y-504J	24
5960.76	YE12	
5960.77	YE12	
5960.78	YE05	73
5960.79	YE05	73
5960.88	Y-548J	75
5960.89	Y-548J	75
5960.99	YE08	
5960.A0	YE08	
5960.A3	Y8005J	64
5960.A4	Y8005J	64
5960.E6	Y8001AS	58
5960.F4	Y-504J	24
5960.F5	Y-504J	24
5960.F8	YE12	
5960.F9	YE05	73
5960.G6	YE08	

PSA	→ NGK	D-Power
5960.K4	Y8005J	64
5960.L4	Y9001AS	72
5961.16	Y-404	
5961.22	Y-810	
5961.35	Y-810	
5961.39	Y-924J	1
5961.53	Y-208T	
5961.54	Y-208T	
5961.58	Y-208T	
5961.A3	Y8005J	64
5961.A4	Y8005J	64
5961.K4	Y8005J	64
5962.03	Y-503J	10
5962.1Q	Y-738U	
5962.2Y	Y-503J	10
5962.2Z	Y-503J	10
5962.3C	Y-504J	24
5962.3E	Y-504J	24
5962.3H	Y-924J	1
5962.7F	Y-504J	24
5962.7G	Y-504J	24
5962.J3	Y-910J	3
5962.T1	Y-910J	3
5962.T2	Y-933J	25
79 325 658 82	Y-810	
79 325 677 18	Y-208T	
91 508 602 80	Y-924J	1
91 908 610 80	Y-924J	1
95 493 206	Y-208T	
95 534 788	Y-208T	
96 236 383	Y-504J	24
96 374 699 80	YE04	40
96 389 858	Y-504J	24
96 501 000 80	YE05	73
96 525 482 80 00	YE08	
96 831 952 80	Y8001AS	58
HG 2621	Y-810	

RENAULT	→ NGK	D-Power
50 01 001 587	Y-208T	
77 00 100 558	Y-506J	7
77 00 100 586	Y-740U	22
77 00 100 635	Y-516J	12
77 00 105 290	Y-927J	19
77 00 111 323	Y-732J	4
77 00 662 199	Y-208T	
77 00 733 076	Y-924J	1
77 00 741 144	Y-924J	1
77 00 854 538	Y-933J	25
77 00 855 865	Y-913J	15
77 00 856 238	Y-913J	15



<b>RENAULT</b>	<b>→ NGK</b>	<b>D-Power</b>
77 00 856 292	Y-933J	25
77 00 861 906	Y-730U	17
77 01 039 387	Y-924J	1
77 01 058 142	Y-522J	
77 01 349 475	Y-924J	1
82 00 090 817	Y-913J	15
82 00 426 227	Y-516J	12
82 00 490 950	Y-732J	4
82 00 682 592	Y1035AS	77
82 00 787 721	Y-516J	12
82 00 794 920	Y1036AS	
85 49 971 00	Y-810	
<b>ROVER</b>	<b>→ NGK</b>	<b>D-Power</b>
ETC 8847	Y-729U	34
<b>SAAB</b>	<b>→ NGK</b>	<b>D-Power</b>
93 178 411	YE07	
93 191 771	Y9003AS	
<b>SEAT =&gt; VW Group</b>		
<b>SKODA =&gt; VW Group</b>		
<b>SMART =&gt; MERCEDES</b>		
<b>SSANGYONG</b>	<b>→ NGK</b>	<b>D-Power</b>
A 667 159 00 01	Y-537AS	
<b>SUZUKI</b>	<b>→ NGK</b>	<b>D-Power</b>
09900-F8Q01	Y-516J	12
09900-RF001	Y-701J	39
18550-79J50	Y1030J	70
18550-79J80	Y9003AS	
18550-80KA0	Y1036AS	
<b>TOYOTA</b>	<b>→ NGK</b>	<b>D-Power</b>
19850-0R010	Y1012J	65
19850-0R020	Y1012J	65
19850-0R022	Y1012J	65
19850-0W010	Y-542J	45
19850-26010	Y1012J	65
19850-26020	Y1012J	65
19850-26021	Y1012J	65
19850-26022	Y1012J	65
19850-27010	Y-531J	44
19850-30010	Y-531J	44
19850-54030	Y-118T1	
19850-54031	Y-118T1	

<b>TOYOTA</b>	<b>→ NGK</b>	<b>D-Power</b>
19850-54050	Y-118R	
19850-54060	Y-168R	
19850-54090	Y-715R	
19850-56012	Y-178T	
19850-56021	Y-128T	
19850-56022	Y-128T	
19850-64010	Y-146R	
19850-64020	Y-703R	
19850-64031	Y-532J	
19850-64050	Y-532J	
19850-67030	Y1013J	63
19850-68010	Y-147T	
19850-68020	Y-197T	
19850-68030	Y-128T	
19850-68040	Y-178T	
19850-68060	Y-197R	
<b>VOLVO</b>	<b>→ NGK</b>	<b>D-Power</b>
3072 5069	Y1005J	56
3121 6248	YE04	40
8631 607	YE12	
8653 698	Y1005J	56
8653 880	Y8008AS	74
<b>VW Group</b>	<b>→ NGK</b>	<b>D-Power</b>
03L 963 319 A	Y1002AS	57
059 963 319 A	Y-501U	31
059 963 319 E	Y-609AS	49
059 963 319 F	Y-609AS	49
060 963 319 F	Y1002AS	57
N 019 1001	Y-207T	
N 019 1002	Y-207T	
N 019 1005	Y-918J	2
N 019 1006	Y-918J	2
N 101 401 04	Y-732J	4
N 102 130 01	Y-918J	2
N 102 130 02	Y-918J	2
N 105 792 01	Y-741U	20
N 105 798 02	YE14	48
N 105 798 03	CZ304	55
N 105 798 05	CZ304	55
N 105 916 02	Y-607AS	50
N 105 916 03	Y-607AS	50
N 105 916 04	CZ104	52
N 105 916 08	CZ104	52
<b>YANMAR</b>	<b>→ NGK</b>	<b>D-Power</b>
124970-77800	Y-116V	
129155-77800	Y-702R	
129155-77801	Y-702U	
129331-77800	Y-110V	





A-6	AB-6
A-7	AB-7
A-8	AB-8
A-8F	A8FS
A-8V	AB-8
A-9F	A9FS
A-9V	AB-8
APR5FS-11	APR5FS
APR5FS-15	APR5FS
APR6F	AP6FS
B10EV	B10EVX
B10FS	R5673-10
B10H	B10HS
B10HN	R5525-10
B10HP	R5530-10
B10HV	B10HVX
B11EN	B11EGV
B11HN	R5525-11
B11HP	R5530-11
B5EB	BR5ES
B5EB-11	BUR5EB-11
B5ES-11	B5ES
B6EB-L-11	BR6ES
B6EFS	BR6EF
B6EMV	B6EM
B6ET	B6EM
B6EV	B6EVX
B6FS	BR6FS
B6HV	BR6HIX
B6HVX	BR6HIX
B-77-HC	B8HCS
B7EB	BR7ES
B7EB-11	BUR7EB-11
B7ET	BR7ET
B7EV	BR7EIX
B7EVX	BR7EIX
B7HV	BR7HIX
B7HVX	BR7HIX
B8EM	BR8EM
B8EMV	BR8ET
B8EN	B8EGV
B8ES-11	B8ES
B8ET	BR8ET
B8EV	B8EVX
B8HN	R5525-8
B8HV	B8HVX
B9EGP	BR9EIX
B9EN	B9EGV
B9EV	B9EVX
B9HCV	B9HVX
B9HN	R5525-9
B9HP	R5530-9
B9HV	B9HVX



BCP4ES	BCPR4ES-11
BCP4ES-11	BCPR4ES-11
BCP5E-11	BCPR5E-11
BCP5ET	BCPR5ET
BCP5EV	BCP5EVX
BCP5EV-11	BCPR5EIX-11
BCP5EVX-11	BCPR5EIX-11
BCP5EY-11	BCPR5EY-11
BCP6E-11	BKR6E-11
BCP6EV	BCP6EVX
BCP6EV-11	BCPR6EVX-11
BCP6EVX-11	BCPR6EVX-11
BCP7E	BCPR7E
BCP7E-11	BCPR7E-11
BCP7ES-11	BKR7E-11
BCP7EV	BCP7EVX
BCPR4E-11	BCPR4ES-11
BCPR4ES	BCPR4ES-11
BCPR5EP-11	BCPR5EIX-11
BCPR5EP-13	BCPR5EIX-11
BCPR5EVX-11	BCPR5EIX-11
BCPR6EP-13	BCPR6EIX-11
BCPR6EP-N-11	BCPR6EIX-11
BCPR6ER	BKR6EK
BCPR7ER	BKR6EK
BCPR7EVX-11	BKR7EIX-11
BCPR7EY	BCPR7E
BK5EKU	BKR5EKU
BK7EKU	BKR7EKU
BKR6EIX-LPG	LPG1
BKUR6EQU	BKR6EQUA
BMR7F	BM7F
BP10EV	BPR10EVX
BP2HA	BP2HS
BP4EFS	TR4
BP4ES-13	BPR4ES-13
BP5EA	BP4EY
BP5EA-11	BP4EY-11
BP5EA-L	BP5EY
BP5EA-L-11	BP5EY-11
BP5EJ	BPR5EY-11
BP5EKN	BPR5EY
BP5ES-L	BP5EY
BP5EV	BPR5EIX
BP5EVX	BPR5EIX
BP5EVX-11	BPR5EIX-11
BP6EA	BP6EY
BP6EA-11	BP6EY-11
BP6EK-A	BPR6EK-A
BP6EKA-V	BPR6EK-A
BP6EKN	BPR6EKN
BP6EV	BP6EVX
BP6EVX-11	BPR6EVX-11



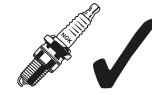

BP6HV	BPR6HIX
BP6HVX	BPR6HIX
BP7E	BPR7E
BP7EFS-13	BP7EFS
BP7EKN	BPR7EKN
BP7EV	BP7EVX
BP7EY-11	BPR7EY-11
BP7HV	BPR7HIX
BP7HVX	BPR7HIX
BP8ES-11	BP8ES
BP8EV	BP8EVX
BP8FS	R5674-8
BP8HSA	BPR8HSA
BP8HVX	BPR8HIX
BP9EV	BPR9EIX
BPR-2E	BPR2ES
BPR4ES-L-11	BPR5ES-11
BPR4FS-20	BPR4FS-15
BPR4S	BP-4
BPR4S-15	BP-4
BPR5EA	BPR5EY
BPR5EA-11	BPR5EY-11
BPR5EA-L	BPR5EY
BPR5EA-L-11	BPR5EY-11
BPR5EF	BPR5EFS
BPR5EF-13	BPR5EFS-13
BPR5EK-A	BPR5EIX-11
BPR5ES-15	BPR5ES-13
BPR5EV	BPR5EIX
BPR5EVX	BPR5EIX
BPR5EVX-11	BPR5EIX-11
BPR5S	BP5S
BPR5S-15	BP5S
BPR6EA	BPR5EY
BPR6EIX-LPG	LPG2
BPR6ES-N-11	BPR6ES-11
BPR6EV	BPR6EVX
BPR6FS-10	BPR6FS
BPR6FS-15	BPR6FS
BPR6HVX	BPR6HIX
BPR6S	BP6S
BPR7EVX	BPR7EIX
BPR7EY	BPR7EIX
BPR7HVX	BPR7HIX
BPR8EVX	BPR8EIX
BPR9EVX	BPR9EIX
BR10EV	BR10EVX
BR4ES-11	BR4ES
BR5EB	BR5ES
BR5EB-11	BUR5EB-11
BR5ES-11	BR5ES
BR5FS-15	BR5FS
BR6EB	BR6ES

BR6EB-11	BUR6EB-11
BR6EB-L	BR7ES
BR6ET	B6EM
BR6FS-15	BR6FS
BR7EB	BR7ES
BR7EB-11	BUR7EB-11
BR7ES-11	BR7ES
BR7EVX	BR7EIX
BR8EV	BR8EVX
BR8HV	BR8HIX
BR8HVX	BR8HIX
BR9EV	BR9EVX
BU5EB-11	BUR5EB-11
BU6EA-11	BUR6EA-11
BU6EB-11	BUR6EB-11
BU7EA-11	BUR7EA-11
BU7EB-11	BUR7EB-11
BUEW	BUE
BUR5EBVX-11	BUR5EB-11
BZ8ES	BR8ES
C10H	R0161-10
C6H	C6HSA
C6M	C6HSA
C7EH-9	CR7EH-9
C7HV	C7HVX
C8EHVX-9	CR8EHVX-9
C8EVX	CR8EVX
C8HV	C8HVX
C9EHVX-9	CR9EHVX-9
C9EVX	CR9EVX
C9H	C8HSA
D-12E	R2525-11
D-4H	DR4HS
D6ES	D6EA
D6HS	D6HA
D6HV	D6HA
D7EV	D7EVX
D8EV	D8EVX
D8HS	D8HA
D8HV	D8HA
D9EV	D9EVX
DCP8EVX	DCPR8EVX
DP5EA-9	DPR5EA-9
DP7EV-9	DPR7EIX-9
DP8EV-9	DPR8EVX-9
DP8EVX-9	DPR8EVX-9
DP9EV-9	DPR9EVX-9
DP9EVX-9	DPR9EVX-9
DPR7EV-9	DPR7EIX-9
DPR7EVX-9	DPR7EIX-9
DPR8EV-9	DPR8EVX-9
DPR9EV-9	DPR9EVX-9
DR8EVX	DR8EIX

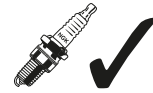

DR9EVX	DR9EIX
GR4VX	GR4
IFR7G-11K	IFR7G-11KS
J10B	JR10B
J9B	JR9B
JR10A	JR10B
JR9A	JR9B
PGR6B	PGR6A-11
PZFR6B	IZFR6B
R0045A-10	R0045J-10
R0045A-11	R0045J-11
R015-10	R0373A-10
R015-8	CR8EIX
R015-9	R0373A-9
R015-95	R0373A-10
R016-10	R0373A-10
R016-105	R0373A-9
R016-11	R0373A-11
R016-8	CR8EIX
R016-9	R0373A-9
R016E-11P	R0373A-11
R017-10	R0373A-10
R017-11	R0373A-11
R017-8	CR8EIX
R017-9	R0373A-9
R017-S11	R0373A-11
R017-S12	R017-12
R0256K-11	R0373A-11
R2097-11P	R2525-10
R216-10	R2525-10
R216-11	R2525-10
R216-12	R2525-11
R216-9	R2525-9
R217-10	R2525-10
R217-11	R2525-10
R217-12	R2525-11
R217-9	R2525-9
R2198-12P	R2525-11
R2270-10	R2349-10
R2270-11	R2349-11
R2270-9	R2349-9
R2430-9	R2349-9
R4118M-10	R4118S-10
R4118M-105	R4118S-105
R4118M-11	R4118S-11
R4118M-7	R4118S-7
R4118M-75	R4118S-75
R4118-M8	R4118S-8
R4118M-85	R4118S-85
R4118-M9	R4118S-9
R4118M-95	R4118S-95
R4339-10	B10EG
R4339-8	B8EG

R4339-9	B9EG
R4452D-10	B10EGP
R4452D-105	B105EGP
R4452D-11	B11EGP
R4452D-8	B8EGP
R4452D-85	B85EGP
R4452D-9	BR9EIX
R4452D-95	B95EGP
R4468-10	R6725-10
R4468-105	R6725-105
R4468-11	R6725-11
R4468-115	R6725-115
R4468-9	R6725-9
R4468A-10	R6725-10
R4468A-105	R6725-105
R4468A-11	R6725-11
R4468A-115	R6725-115
R4468A-9	R6725-9
R4630A-10	R7376-10
R4630A-105	R7376-10
R4630A-11	R7376-10
R4630A-8	R7376-8
R4630A-9	R7376-9
R5184-11	R7282-11
R5300A-105	R7282-105
R5300A-11	R7282-11
R5400-10	R7437-10
R5400-7	BCPR7EIX
R5400-8	R7435-8
R5400-9	R7435-9
R5540-10	R5540F-10
R5540-105	R5540F-105
R5540-95	R5540F-10
R5540B-105	R5540F-105
R5671-8	R5671A-8
R5671-9	R5671A-9
R5672-8	R5672A-8
R5672-9	R5672A-9
R5686-10	R7436-10
R5686-11	R7436-10
R5686-8	R7436-8
R5686-9	R7436-9
R5687-10	R7436-10
R5687-8	R7436-8
R5687-9	R7436-9
R5796-8	R7436-8
R5830-10	R7436-10
R5830-9	R7436-9
R6120-10	R7282-10
R6120-105	R7282-105
R6120-11	R7282-11
R6120A-10	R7282A-10
R6120A-105	R7282A-105





## PS/HP ↔ kW

PS/HP	kW	kW	PS/HP	PS/HP	kW	kW	PS/HP
1	1,36	1	0,736	1	1,36	1	0,736
50	37	40	54	325	239	315	428
55	40	45	61	330	243	320	435
60	44	50	68	335	246	325	442
65	48	55	75	340	250	330	448
70	51	60	82	345	254	335	455
75	55	65	88	350	257	340	462
80	59	70	95	355	261	345	469
85	63	75	102	360	265	350	476
90	66	80	109	365	268	355	482
95	70	85	115	370	272	360	489
100	74	90	122	375	276	365	496
105	77	95	129	380	279	370	503
110	81	100	136	385	283	375	510
115	85	105	143	390	287	380	516
120	88	110	149	395	290	385	523
125	92	115	156	400	294	390	530
130	96	120	163	405	298	395	537
135	99	125	170	410	301	400	543
140	103	130	177	415	305	405	550
145	107	135	183	420	309	410	557
150	110	140	190	425	313	415	564
155	114	145	197	430	316	420	571
160	118	150	204	435	320	425	577
165	121	155	211	440	324	430	584
170	125	160	217	445	327	435	591
175	129	165	224	450	331	440	598
180	132	170	231	455	335	445	605
185	136	175	238	460	338	450	611
190	140	180	245	465	342	455	618
195	143	185	251	470	346	460	625
200	147	190	258	475	349	465	632
205	151	195	265	480	353	470	639
210	154	200	272	485	357	475	645
215	158	205	279	490	360	480	652
220	162	210	285	495	364	485	659
225	165	215	292	500	368	490	666
230	169	220	299	505	371	495	673
235	173	225	306	510	375	500	679
240	176	230	313	515	379	505	686
245	180	235	319	520	382	510	693
250	184	240	326	525	386	515	700
255	188	245	333	530	390	520	707
260	191	250	340	535	393	525	713
265	195	255	346	540	397	530	720
270	199	260	353	545	401	535	727
275	202	265	360	550	404	540	734
280	206	270	367			545	740
285	210	275	374			550	747
290	213	280	380				
295	217	285	387				
300	221	290	394				
305	224	295	401				
310	228	300	408				
315	232	305	414				
320	235	310	421				



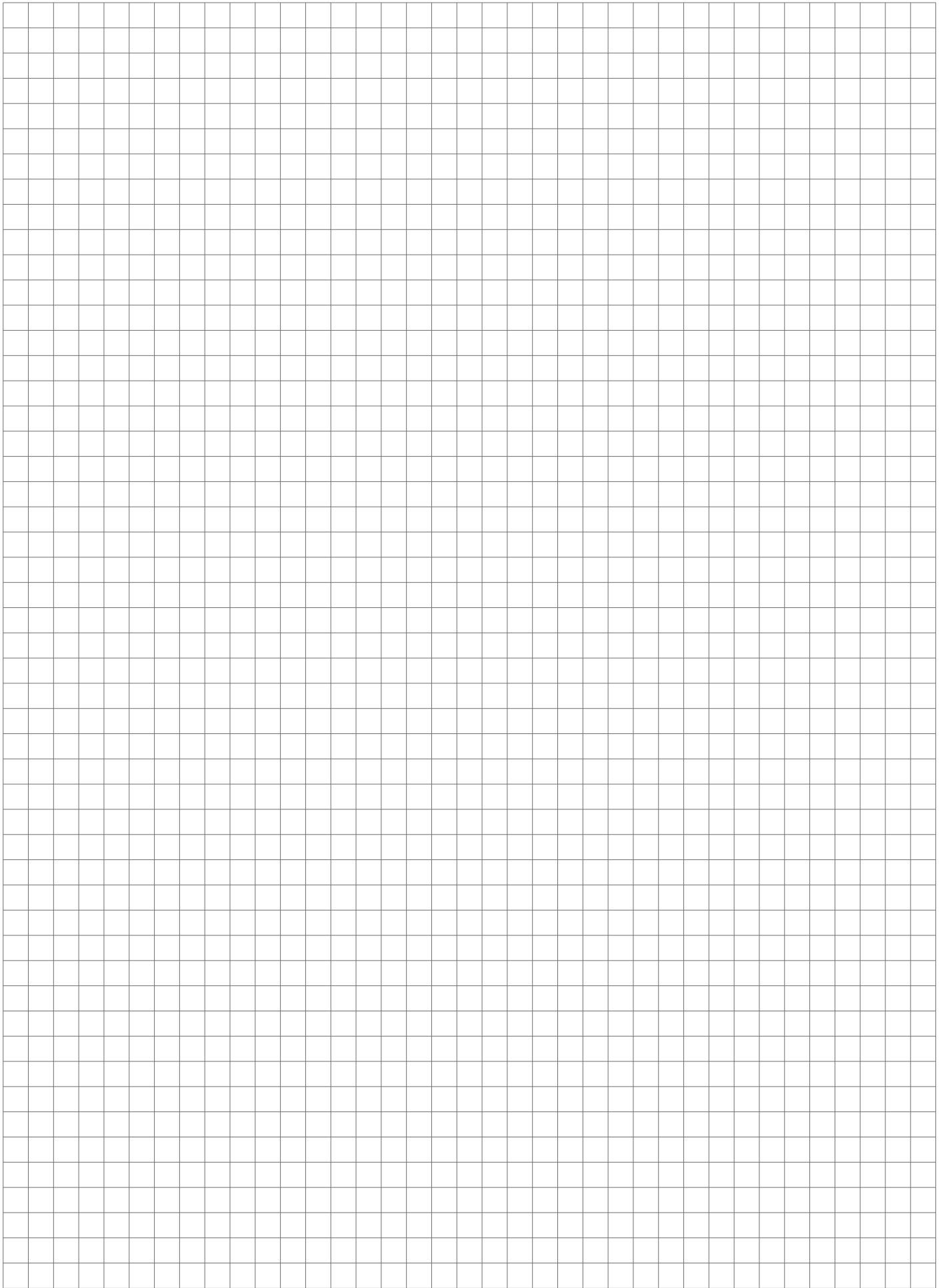

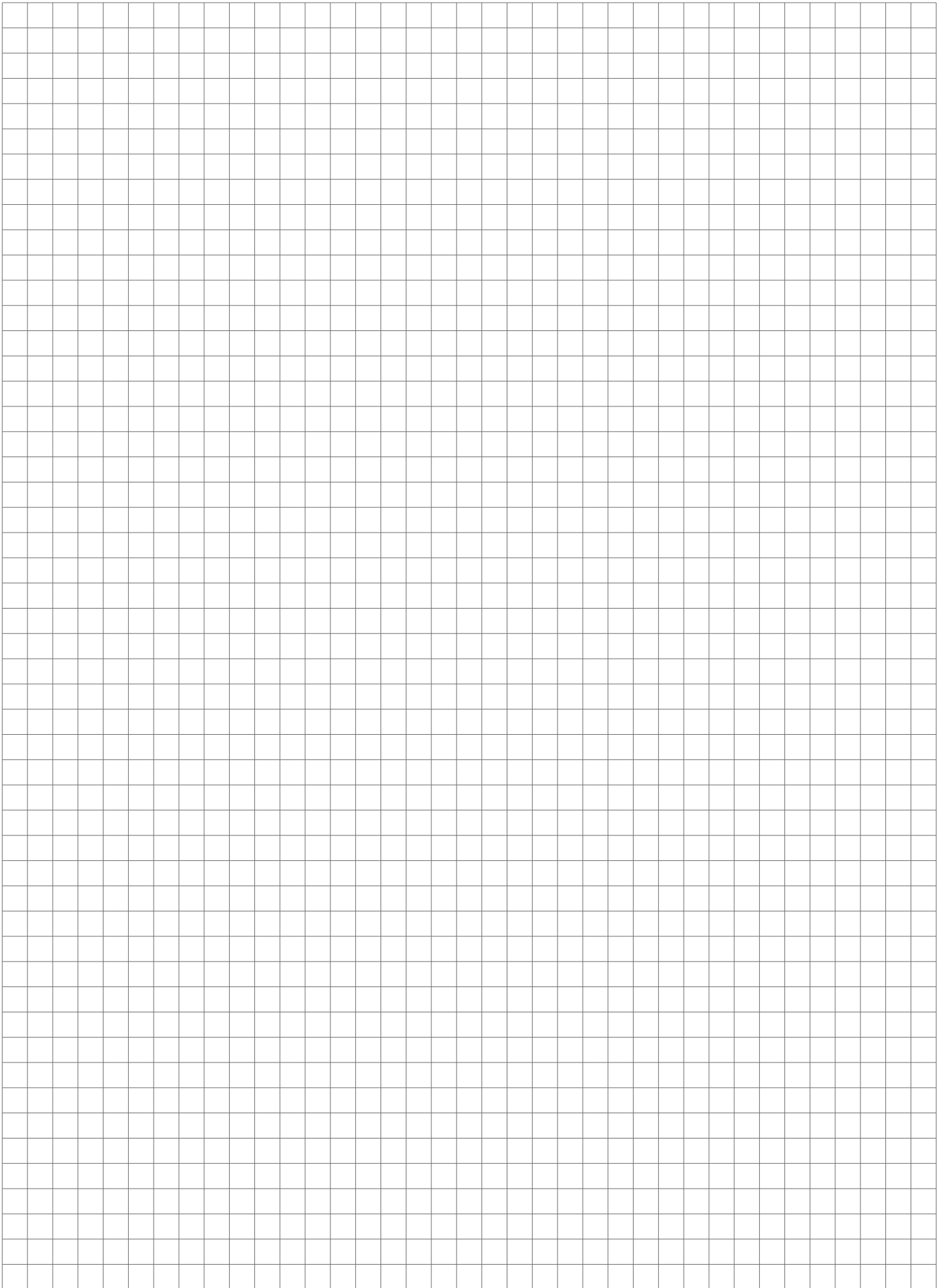

The screenshot displays the 'Spark plugs' section of the e-learning module. It features a graph titled 'Spark plug temperature (firing end)' on the y-axis, with values 450 °C, 850 °C, and 1000 °C. The x-axis is 'Engine load' from 0% to 100%. The graph is divided into four regions: 'Fouling region' (low temperature, low load), 'Optimal temperature region' (middle temperature, middle load), 'Safety margin' (high temperature, middle load), and 'Overheating region' (very high temperature, high load). A character in blue overalls stands next to a fire extinguisher. Below the graph are buttons for 'hot', 'optimal', and 'cold', and an 'Engine load' slider. Text on the right explains 'The meaning of the heat rating'.

**The meaning of the heat rating**

The generation of heat varies greatly from engine to engine. For example, a lawn mower will generate less heat than a racing car or a turbocharged engine can run significantly hotter than a naturally aspirated engine.

Therefore a spark plug must be selected that can conduct a precisely defined amount of heat energy to the cylinder head and ensure that the optimal operating temperature range is maintained.

The heat rating of a spark plug provides information about its thermal performance. The following applies for NGK spark plugs: The higher the heat rating number, the higher the thermal performance.

The heat rating number is to be found within the technical part number designation which is marked on the body of NGK's spark plugs (e.g. BKR7EES).

The screenshot displays the 'Ignition sequence' section of the e-learning module. It features a diagram of an engine with four cylinders, showing the flow of high voltage from the ignition coil through a distributor cap to the spark plug terminals. A character in blue overalls stands next to the engine. Below the diagram are buttons for 'fast' and 'slow' under the 'Speed' label. Text on the right explains the 'Ignition sequence'.

**Ignition sequence**

In older systems a central ignition coil generates the high voltage necessary for the ignition of the air-fuel mixture.

A mechanical ignition distributor ensures that this voltage is sent to the correct cylinder's spark plug at the right time.

The ignition high voltage is fed through a distributor cap and the ignition HT lead which is connected to the spark plug terminal. From here it reaches the tip of the centre electrode and when sufficient voltage is available to overcome the resistance of the air gap between the centre and ground electrode electrical energy discharges to earth in the form of a spark.

In more modern systems an individual 'pencil coil' is often fitted directly to each spark plug. With these fully-electronic ignition systems neither mechanical ignition distributors or high-voltage ignition cables are required.





**NGK SPARK PLUG EUROPE GMBH SP. Z O.O.**

Przedstawicielstwo w Polsce

ul. Tadeusza Rejtana 17 lok. 10 · 02-516 Warszawa

Phone +48 22 646 35 60, -646 39 62 · Fax +48 22 646 27 46

[www.ngkntk.pl](http://www.ngkntk.pl)



**NGK SPARK PLUG EUROPE GmbH**